

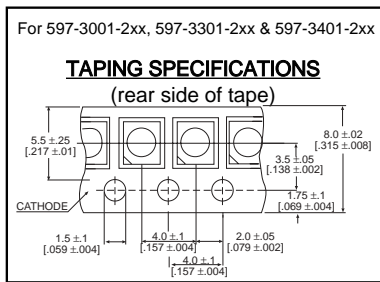

**THE DATASHEET OF**  
**5973001207F**

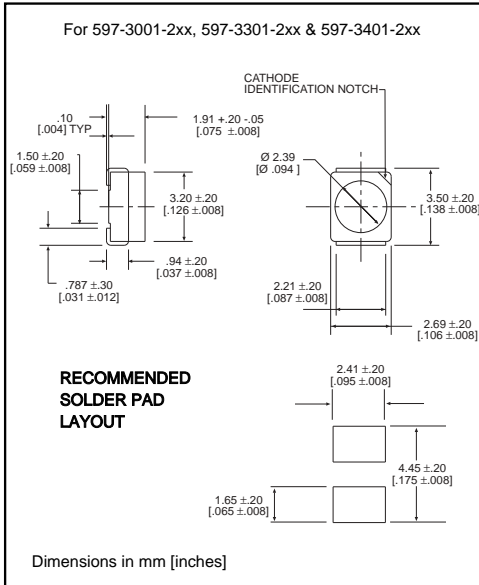



<b>PART NO.*</b>	<b>COLOR</b>
597-3001-2xx	Red
597-3121-2xx	AlGaAs Red
597-3211-2xx	Orange
597-3301-2xx	Green
597-3401-2xx	Yellow

**Features**

- Compatible with automatic placement equipment
- Compatible with infrared reflow processes
- Packaged on 8mm tape, 7" reels (meets EIA-481-1 standard)
- Helps to eliminate mixed technology PC board processing
- Compatible with Dialight's Optopipe™ Series light pipes

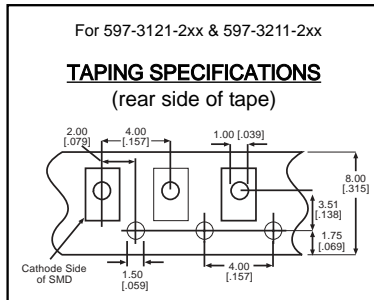
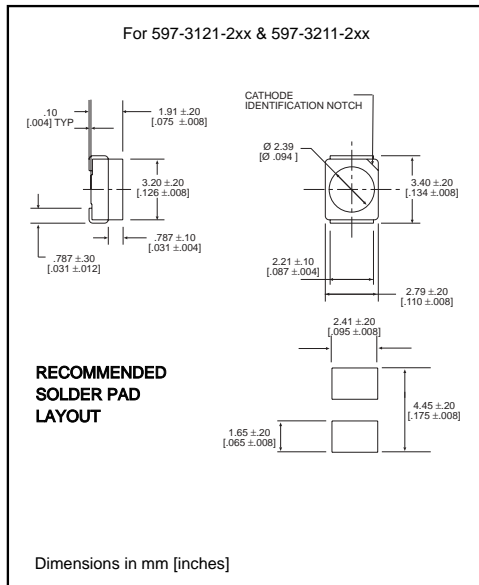

<b>*ORDERING INFORMATION</b>	
<b>597-3xx1-2xx</b>	
packaging option	
02	20 pieces on tape
07	7" reel, 2000 pcs/reel

# 597-3xx1-2xx

<b>ABSOLUTE MAXIMUM RATINGS</b> ( $T_A=25^\circ\text{C}$ )	Red <b>-3001</b>	AlGaAs Red <b>-3121</b>	Green <b>-3301</b>	Orange <b>-3211</b>	Yellow <b>-3401</b>
Power Dissipation (mW)	100	100	100	100	60
Forward Current (mA)	30	30	30	30	20
Derating (mA/°C) <i>From 25°C From 55°C</i>	.4	.66*	.4	.66*	.25
Peak Current (mA) <i>Pulse width = 100 <math>\mu\text{s}</math> *Pulse width = 10 <math>\mu\text{s}</math></i>	120	500*	120	500*	80
Operating Temperature (°C)	-55/+85	-55/+100	-55/+85	-55/+100	-55/+85
Storage Temperature (°C)	-55/+100	-55/+100	-55/+100	-55/+100	-55/+100
Soldering Profile	235°C peak 15 seconds, 185° for 90 seconds				

*Solder Adherence per MIL-STD-202E, Method 208C*

<b>OPERATING CHARACTERISTICS</b> ( $T_A=25^\circ\text{C}$ )		Red <b>-3001</b>	AlGaAs Red <b>-3121</b>	Green <b>-3301</b>	Orange <b>-3211</b>	Yellow <b>-3401</b>
Luminous Intensity (mcd) $I_F=10\text{mA}$	Min.	4	10	4	6.3	4
	Typical	10	20	10		7
Peak Wavelength (nm) $\lambda_{\text{Peak}}$	Typical	630	660	565	610	585
Viewing Angle ( $2\Theta_{1/2}$ )	Typical	120°	120°	120°	120°	120°
Forward Voltage (V) $I_F=20\text{mA}$ * $I_F=10\text{mA}$	Typical	2	1.75*	2.1	2*	2.1
	Max.	2.8	2.6*	2.8	2.6*	2.8
Reverse Voltage (V), $I_R=10\mu\text{A}$	Min.	5	5	5	5	5

$\Theta_{1/2}$  is the off axis angle at which the luminous intensity is half the axial luminous intensity







## Looking for pricing, stock, or lifecycle information?

Click below to explore more details on WIN SOURCE:

 [View 5973001207F](#) on WIN SOURCE

 [Dialight](#) Information

## Optimize Your Supply Chain with WIN SOURCE Solutions

-  Global Sourcing Solution
-  Obsolete Management
-  Cost Control Management
-  Shortage Management
-  Alternative Solution
-  Excess Inventory Management