



**THE DATASHEET OF
RFANT5220110A2T**



RF Devices & Customer made Antenna

www.passivecomponent.com

Product catalog

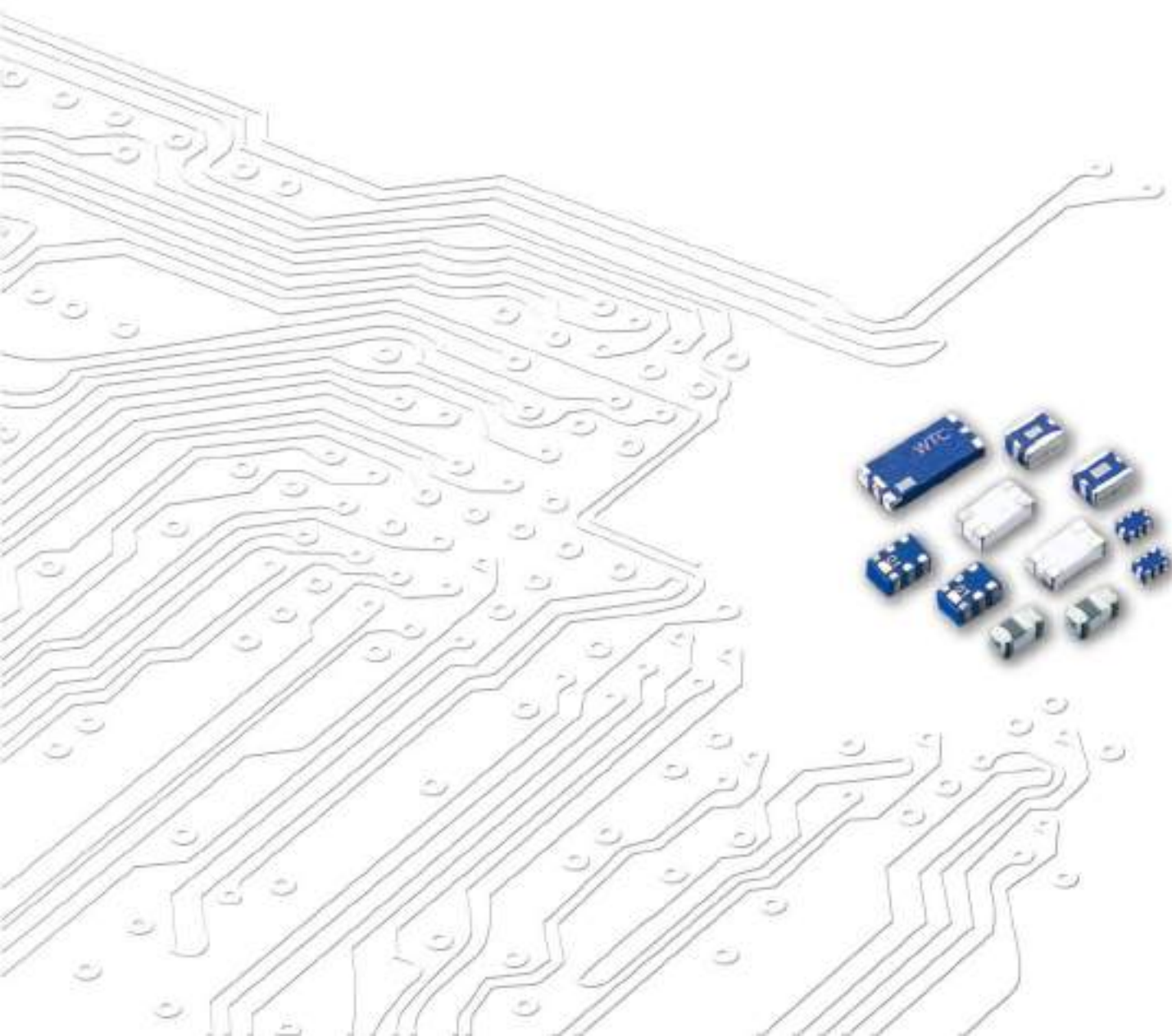

Product Portfolio



Multilayer Ceramic Capacitors



Chip Resistors



Disc Capacitors



Inductors



RF Filters



Antenna

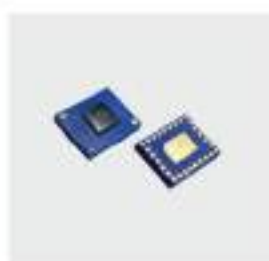

Antenna Switch & Module



MOV Varistors

IEC-63 Nominal Resistance / Capacitance

E1	100																							
E3	100			220						470														
E6	100	150	220	330	470	680																		
E12	100	120	150	180	220	270	330	390	470	560	680	820												
E24	100	110	120	130	150	160	180	200	220	240	270	300	330	360	390	430	470	510	560	620	680	750	820	910
E96	100	102	121	124	147	150	178	182	215	221	261	267	316	324	383	392	464	475	562	576	681	698	825	845
	105	107	127	130	154	158	187	191	226	232	274	280	332	340	402	412	487	499	590	604	715	732	866	887
	110	113	133	137	162	165	196	200	237	243	287	294	348	357	422	432	511	523	619	634	750	768	909	931
	115	118	140	143	169	174	205	210	249	255	301	309	365	374	442	453	536	549	649	665	787	806	953	976

E6: $\sqrt[6]{10} \approx 1.46$ E12: $\sqrt[12]{10} \approx 1.21$

E1 series resistance: 1Ω, 10Ω, 100Ω, 1000Ω, 10000Ω, 100000Ω

INDEX

Subject	Page
ORDERING CODE	1~4
CHIP ANTENNA	5~10
■ 1.575GHz GPS BAND WORKING FREQUENCY	
■ Bluetooth/WiFi BAND WORKING FREQUENCY	
■ WiMAX BAND WORKING FREQUENCY	
HIGH FREQUENCY MULTILAYER BAND PASS FILTER	11~27
■ 2.4GHz BAND WORKING FREQUENCY	
■ WiMAX BAND WORKING FREQUENCY	
■ 5GHz BAND WORKING FREQUENCY	
■ 1558 ~ 1606 MHz GNSS Band Applications	
■ 860~960MHz/1805~2025 MHz Band Application	
■ MoCA / Docsis Application	
■ LTE BAND Application	
HIGH FREQUENCY MULTILAYER BALANCED FILTER	28~31
■ 2.4GHz BAND WORKING FREQUENCY	
HIGH FREQUENCY MULTILAYER LOW PASS FILTER	32~41
■ GSM850/900GHz BAND WORKING FREQUENCY	
■ DCS/PCS BAND WORKING FREQUENCY	
■ 2.4GHz BAND WORKING FREQUENCY	
■ 5GHz BAND WORKING FREQUENCY	
■ LTE BAND APPLICATION	
■ MoCA Application	
HIGH FREQUENCY MULTILAYER HIGH PASS FILTER	42~43
■ ISM 2.4/ 5GHz Band Application	
■ 2496 ~ 2690 MHz BAND WORKING FREQUENCY	
■ 5GHz BAND WORKING FREQUENCY	
■ MoCA Application	
BALUN TRANSFORMERS	44~53
■ ISM Band 2.4GHz Application	
■ ISM Band 5GHz Application	
■ LTE Band Application	
■ GSM 850/ GSM 900/ DCS1800/ PCS1900 Application	
DIPLEXER	54~65
■ ISM Band 2.4GHz/5GHz Application	
■ GPS 1.575GHz/ISM 2.4GHz/5GHz Band Application	
■ 892 MHz & 1.94GHz Band Working Frequency	
TRIPLEXER	66~69
■ GPS 1.575GHz/ISM 2.4GHz/5GHz Band RF Application	
COMMON MODE FILTER	70
■ DISCRETE CMF for HIGH SPEED TRANSMISSION LINES · USB2.0 · IEEE1394 · LVDS(mini)	
COUPLER	71~75
■ ISM Band 2.4GHz Application	
■ ISM Band 2.4/5GHz Application	
■ LTE BAND Application	
SAW FILTER	76~83
ANTENNA SWITCH (GPIO)	84~85
ANTENNA SWITCH (MIPI)	86~88
ANTENNA SWITCH (LTE Antenna Tuner- GPIO)	89
ANTENNA SWITCH (Network-GPIO)	90
Customer made Antenna	91~101
■ Dipole Antenna (None Cable and With Cable)	
■ PCB Antenna	
■ FPA Antenna	
■ Metal Antenna	
■ NFC Antenna	
■ Connector	

*The specifications are subject to change or our products in it may be discontinued without advance notice. Please check with our sales representatives or product engineers before ordering.

*This catalog has only typical specifications because there is no space for detailed specifications. Therefore, please approve our product specifications or transact the approval sheet for product specifications before ordering.

■ **CHIP ANTENNA**

RF	ANT	321612	0	A	5	T
<u>Type code</u>	<u>Product code</u>	<u>Dimension code</u>	<u>Unit of dimension</u>	<u>Application</u>	<u>Specification</u>	<u>Packing</u>
RF/RG: device	ANT : Antenna FRA : Free Antenna ECA : SMD Antenna	Per 2 digits of Length, Width, Thickness 321612 = Length =32 Width = 16 Thickness = 12	0 : 0.1 mm 1 : 1.0 mm	A: 2.4GHz ISM Band E : GPS 1.5GHz L : 2.4/5.2/5.8GHz Tri Band W : WiMAX	Code from 0-9 dependent on different electrical specification	T: 7" Reeled G: 13" Reeled

■ **HIGH FREQUENCY MULTILAYER BAND PASS FILTER**

RF	BPF	322515	0	A	4	T
<u>Type code</u>	<u>Product code</u>	<u>Dimension code</u>	<u>Unit of dimension</u>	<u>Application</u>	<u>Specification</u>	<u>Packing</u>
RF device	BPF : Band Pass Filter	Per 2 digits of Length, Width, Thickness 322515 = Length =32 Width = 25 Thickness = 15	0 : 0.1 mm 1 : 1.0 mm	A : 2.4GHz ISM Band W : WiMAX K : ISM 5.2/5.8 Dual Band	Code from 0-9 dependent on different electrical specification	T: 7" Reeled G: 13" Reeled

■ **HIGH FREQUENCY MULTILAYER BALANCED FILTER**

RF	BPB	252009	0	A	7	T
<u>Type code</u>	<u>Product code</u>	<u>Dimension code</u>	<u>Unit of dimension</u>	<u>Application</u>	<u>Specification</u>	<u>Packing</u>
RF/RG: device	BPB : Balanced Type Band Pass Filter	Per 2 digits of Length, Width, Thickness 252009 = Length =25 Width = 20 Thickness = 09	0 : 0.1 mm 1 : 1.0 mm	A : 2.4GHz ISM Band W : WiMAX	Code from 0-9 dependent on different electrical specification	T: 7" Reeled G: 13" Reeled

■ **HIGH FREQUENCY MULTILAYER LOW PASS FILTER**

RF	LPF	201211	0	A	0	T
<u>Type code</u>	<u>Product code</u>	<u>Dimension code</u>	<u>Unit of dimension</u>	<u>Application</u>	<u>Specification</u>	<u>Packing</u>
RF device	LPF : Low Pass Filter	Per 2 digits of Length, Width, Thickness 201210 = Length =20 Width = 12 Thickness = 11	0 : 0.1 mm 1 : 1.0 mm	A : 2.4GHz ISM Band K : ISM 5.2/5.8 Dual Band	Code from 0-9 dependent on different electrical specification	T: 7" Reeled G: 13" Reeled

■ **HIGH FREQUENCY MULTILAYER HIGH PASS FILTER**

RF	HPF	252009	0	L	0	T
<u>Type code</u>	<u>Product code</u>	<u>Dimension code</u>	<u>Unit of dimension</u>	<u>Application</u>	<u>Specification</u>	<u>Packing</u>
RF device	HPF : High Pass Filter	Per 2 digits of Length, Width, Thickness 252009 = Length =2.5 Width = 2.0 Thickness = 0.9	0 : 0.1 mm 1 : 1.0 mm	L : 2.4/4.9/5.2/5.8GHz Multiband Application	Code from 0-9 dependent on different electrical specification	T: 7" Reeled G: 13" Reeled

■ **BALUN TRANSFORMERS**

RF	BLN	201208	0	A	4	T
<u>Type code</u>	<u>Product code</u>	<u>Dimension code</u>	<u>Unit of dimension</u>	<u>Application</u>	<u>Specification</u>	<u>Packing</u>
RF/RG: device	BLN : BALUN	Per 2 digits of Length, Width, Thickness 201208 = Length =20 Width = 12 Thickness = 08	0 : 0.1 mm 1 : 1.0 mm	A : 2.4GHz ISM Band K : ISM 5.2/5.8 Dual Band	Code from 0-9 dependent on different electrical specification	T: 7" Reeled G: 13" Reeled

■ **DIPLEXER**

RF	DIP	201210	0	L	0	T
<u>Type code</u>	<u>Product code</u>	<u>Dimension code</u>	<u>Unit of dimension</u>	<u>Application</u>	<u>Specification</u>	<u>Packing</u>
RF device	DIP : Diplexer	Per 2 digits of Length, Width, Thickness 201210 = Length =20 Width = 12 Thickness = 10	0 : 0.1 mm 1 : 1.0 mm	L : 2.4/4.9/5.2/5.8GHz Multiband Application	Code from 0-9 dependent on different electrical specification	T : 7" Reeled G:13" Reeled

■ **TRIPLEXER**

RF	TIP	2109	A	T	MOT63
<u>Type code</u>	<u>Product code</u>	<u>Dimension code</u>	<u>Pin Define</u>	<u>Application</u>	<u>Specification</u>
RF device	TIP : Triplexer	Per 2 digits of Length, Width, Thickness e.g. : 21 = Length 2.0 mm, Width 1.2 mm, 09= Thickness 0.9 mm	Design Code	T: GPS/ ISM 2.4GHz/5 GHz	Design Code

■ **COMMON MODE FILTER**

RF	CMF	122010	0	M	3	T
<u>Type code</u>	<u>Product code</u>	<u>Dimension code</u>	<u>Unit of dimension</u>	<u>Application</u>	<u>Specification</u>	<u>Packing</u>
RF/RG: device	CMF : Common Mode Filter	Per 2 digits of Length, Width. 122010 = Length =12 Width = 20 Thickness = 10	0 : 0.1 mm 1 : 1.0 mm	M: USB 2.0/ IEEE1394	Code from 0-9 dependent on different electrical specification	T : 7" Reeled

■ **COUPLER**

RF	CPL	18	10	B	2450	T
<u>Type code</u>	<u>Product code</u>	<u>Dimension code</u>	<u>Coupling Factor</u>	<u>Unit</u>	<u>Application</u>	<u>Packing</u>
RF device	Coupler	e.g. : 18 = Length 16, Width 08, 15= Length 10, Width 05,	10 dB	dB	2.4 GHZ ISM Band	T : 7" Reeled

■ **SAW FILTER**

SF	1411	2595	B38	03	T
<u>Product code</u>	<u>Dimension code</u>	<u>Frequency</u>	<u>Application</u>	<u>Serial Number</u>	<u>Packing</u>
SF:SAW Filter DF:SAW DUPLXER	Per 2 digits of Length, Width 1411= Length 1.4mm Width 1.1mm	2595:Center Freq (2595MHz)	B38:Band38	Design Code	T: 7" Reeled

■ **ANTENNA SWITCH**

RF	ASW	D	H2418A	T
<u>Type code</u>	<u>Product code</u>	<u>Application</u>	<u>Serial Number</u>	<u>Packing</u>
RF device	ASW: Antenna Switch	D: SP8T	Design Code	T: 7" Reeled

■ **ANTENNA SWITCH MODULE**

RM	ASM	N	T1492A	T
<u>Type code</u>	<u>Product code</u>	<u>Application</u>	<u>Serial Number</u>	<u>Packing</u>
RM: Walsin RF Module Device	ASM: Antenna Switch Module	N: SP16T	Design Code	T: 7" Reeled

■ Dipole Antenna

RF	DPA	8709	00	S	B	A	B	8	01
Type code	Product code	Dimension code	Cable Length code	Connector Brand code	Type of Connector code	Application code	Project status code	Wire Diameter code	Project code
RF device	DPA : Dipole Antenna	Per 2 digits of Length, Width 8709 = Length = 87 Width = 9.95	2 digits for cable length 00= None Cable	A: N C:MCX D:IPEX III E: IPEX IV F: IPEX A13 H: Hirose I: IPEX K:F M: MMCX S: SMA T: TNC U:MURATA N: None	A: Reverse Female B: Reverse Male F: Female M: Male N: None	0: 0GHz 5: 5 GHz A: 2.4GHz ISM band B: GSM 900/1800 dual band G: GPS band L: 2.4/5.2/5.8 GHz tri-band T:LTE band U:UHF W: WCDMA band	B: MP T:During Test X: Pile Run	0:None 1:Ø0.81 2:Ø1.32 3:Ø1.13 4:Low LossØ1.13 5:Ø0.50 6:RG316 7:Ø1.37 8:RG178 9:Low LossØ1.37 A:RG174 B:1.5C-2V	01~99 series number

■ PCB Antenna

RF	PCA	4305	10	N	N	A	B	4	01
Type code	Product code	Dimension code	Cable Length code	Connector Brand code	Type of Connector code	Application code	Project status code	Wire Diameter code	Project code
RF device	PCA : PCB Antenna	Per 2 digits of Length, Width 4305 = Length = 43 Width = 5	2 digits for cable length 10= Cable Length: 10cm	A: N C:MCX D:IPEX III E: IPEX IV F: IPEX A13 H: Hirose I: IPEX K:F M: MMCX S: SMA T: TNC U:MURATA N: None	A: Reverse Female B: Reverse Male F: Female M: Male N: None	0: 0GHz 5: 5 GHz A: 2.4GHz ISM band B: GSM 900/1800 dual band G: GPS band L: 2.4/5.2/5.8 GHz tri-band T:LTE band U:UHF W: WCDMA band	B: MP T:During Test X: Pile Run	0:None 1:Ø0.81 2:Ø1.32 3:Ø1.13 4:Low LossØ1.13 5:Ø0.50 6:RG316 7:Ø1.37 8:RG178 9: Low LossØ1.37 A:RG174 B:1.5C-2V	01~99 series number

■ FPA Antenna

RF	FPA	3025	10	I	M	A	B	3	01
Type code	Product code	Dimension code	Cable Length code	Connector Brand code	Type of Connector code	Application code	Project status code	Wire Diameter code	Project code
RF device	FPA : FPA Antenna	Per 2 digits of Length, Width 3025 = Length = 30 Width = 25	2 digits for cable length 10= Cable Length: 10cm	A: N C:MCX D:IPEX III E: IPEX IV F: IPEX A13 H: Hirose I: IPEX K:F M: MMCX S: SMA T: TNC U:MURATA N: None	A: Reverse Female B: Reverse Male F: Female M: Male N: None	0: 0GHz 5: 5 GHz A: 2.4GHz ISM band B: GSM 900/1800 dual band G: GPS band L: 2.4/5.2/5.8 GHz tri-band T:LTE band U:UHF W: WCDMA band	B: MP T:During Test X: Pile Run	0:None 1:Ø0.81 2:Ø1.32 3:Ø1.13 4:Low LossØ1.13 5:Ø0.50 6:RG316 7:Ø1.37 8:RG178 9: Low LossØ1.37 A:RG174 B:1.5C-2V	01~99 series number

■ Metal Antenna

RF	MTA	3109	10	I	M	L	B	7	01
Type code	Product code	Dimension code	Cable Length code	Connector Brand code	Type of Connector code	Application code	Project status code	Wire Diameter code	Project code
RF device	MTA : Metal Antenna	Per 2 digits of Length, Width 3109 = Length = 31 Width = 9	2 digits for cable length 10= Cable Length: 10cm	A: N C:MCX D:IPEX III E: IPEX IV F: IPEX A13 H: Hirose I: IPEX K:F M: MMCX S: SMA T: TNC U:MURATA N: None	A: Reverse Female B: Reverse Male F: Female M: Male N: None	0: 0GHz 5: 5 GHz A: 2.4GHz ISM band B: GSM 900/1800 dual band G: GPS band L: 2.4/5.2/5.8 GHz tri-band T:LTE band U:UHF W: WCDMA band	B: MP T:During Test X: Pile Run	0:None 1:Ø0.81 2:Ø1.32 3:Ø1.13 4:Low LossØ1.13 5:Ø0.50 6:RG316 7:Ø1.37 8:RG178 9: Low LossØ1.37 A:RG174 B:1.5C-2V	01~99 series number

■ **Cable Assembly**

RF	CBA	1613	10	I	M	3	B	7	01
Type code	Product code	Dimension code	Cable Length code	Connector Brand code	Type of Connector code	Application code	Project status code	Wire Diameter code	Project code
RF device	CBA : Cable Assembly	Per 2 digits of Length, Width 1613 = Length = 16.8 Width = 13.7	2 digits for cable length 10= Cable Length: 10cm	A: N C:MCX D:IPEX III E: IPEX IV F: IPEX A13 H: Hirose I: IPEX K:F M: MMCX S: SMA T: TNC U:MURATA N: None	A: Reverse Female B: Reverse Male F: Female M: Male N: None	0: 0GHz 3: 3GHz 6: 6GHz	B: MP T:During Test X: Pile Run	0:None 1:00.81 2:01.32 3:01.13 4:Low Loss01.13 5:00.50 6:RG316 7:01.37 8:RG178 9: Low Loss01.37 A:RG174 B:1.5C-2V	01-99 series number

■ **Connector**

RF	CON	0201	00	D	F	6	B	0	01
Type code	Product code	Dimension code	Cable Length code	Connector Brand code	Type of Connector code	Application code	Project status code	Wire Diameter code	Project code
RF device	CON : Connector	Per 2 digits of Length, Width 0201 = Length = 2.05 Width = 1.40	2 digits for cable length 00= None Cable	A: N C:MCX D:IPEX III E: IPEX IV F: IPEX A13 H: Hirose I: IPEX K:F M: MMCX S: SMA T: TNC U:MURATA N: None	A: Reverse Female B: Reverse Male F: Female M: Male N: None	0: 0GHz 3: 3GHz 6: 6GHz	B: MP T:During Test X: Pile Run	0:None 1:00.81 2:01.32 3:01.13 4:Low Loss01.13 5:00.50 6:RG316 7:01.37 8:RG178 9: Low Loss01.37 A:RG174 B:1.5C-2V	01-99 series number

■ **NFC Antenna**

RF	NFC	0201	00	N	N	N	B	0	01
Type code	Product code	Dimension code	Cable Length code	Connector Brand code	Type of Connector code	Application code	Project status code	Wire Diameter code	Project code
RF device	NFC : Near Field Communication Antenna	Per 2 digits of Length, Width 5339 = Length = 53.7 Width = 39.7	2 digits for cable length 00= None Cable	A: N C:MCX D:IPEX III E: IPEX IV F: IPEX A13 H: Hirose I: IPEX K:F M: MMCX S: SMA T: TNC U:MURATA N: None	A: Reverse Female B: Reverse Male F: Female M: Male N: None	N: NFC	B: MP T:During Test X: Pile Run	0:None 1:00.81 2:01.32 3:01.13 4:Low Loss01.13 5:00.50 6:RG316 7:01.37 8:RG178 9: Low Loss01.37 A:RG174 B:1.5C-2V	01-99 series number

■ **WPC Antenna**

RF	WPC	5830	00	N	N	N	B	0	01
Type code	Product code	Dimension code	Cable Length code	Connector Brand code	Type of Connector code	Application code	Project status code	Wire Diameter code	Project code
RF device	WPC : Wireless Power Charging Antenna	Per 2 digits of Length, Width 5830 = Length = 58 Width = 30	2 digits for cable length 00= None Cable	A: N C:MCX D:IPEX III E: IPEX IV F: IPEX A13 H: Hirose I: IPEX K:F M: MMCX S: SMA T: TNC U:MURATA N: None	A: Reverse Female B: Reverse Male F: Female M: Male N: None	N: NFC	B: MP T:During Test X: Pile Run	0:None 1:00.81 2:01.32 3:01.13 4:Low Loss01.13 5:00.50 6:RG316 7:01.37 8:RG178 9: Low Loss01.37 A:RG174 B:1.5C-2V	01-99 series number

Remark:

- Central Frequency should be defined after customers' application approval.

CHIP ANTENNA

■ STRUCTURE AND PIN ASSOCIATED

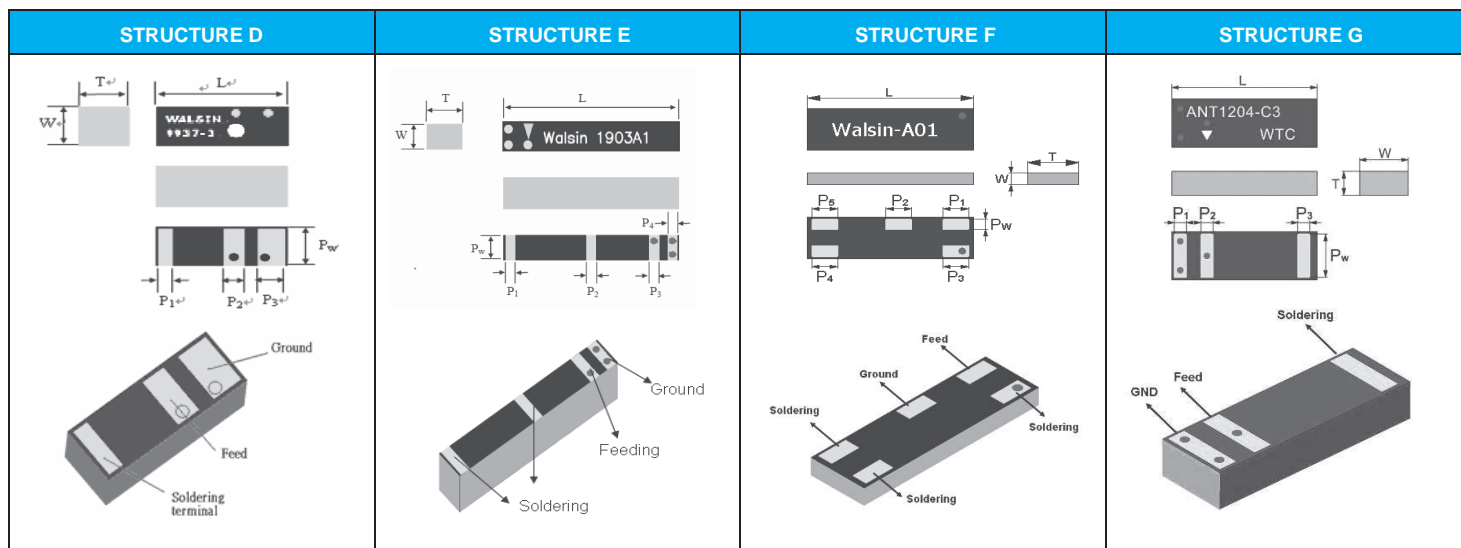
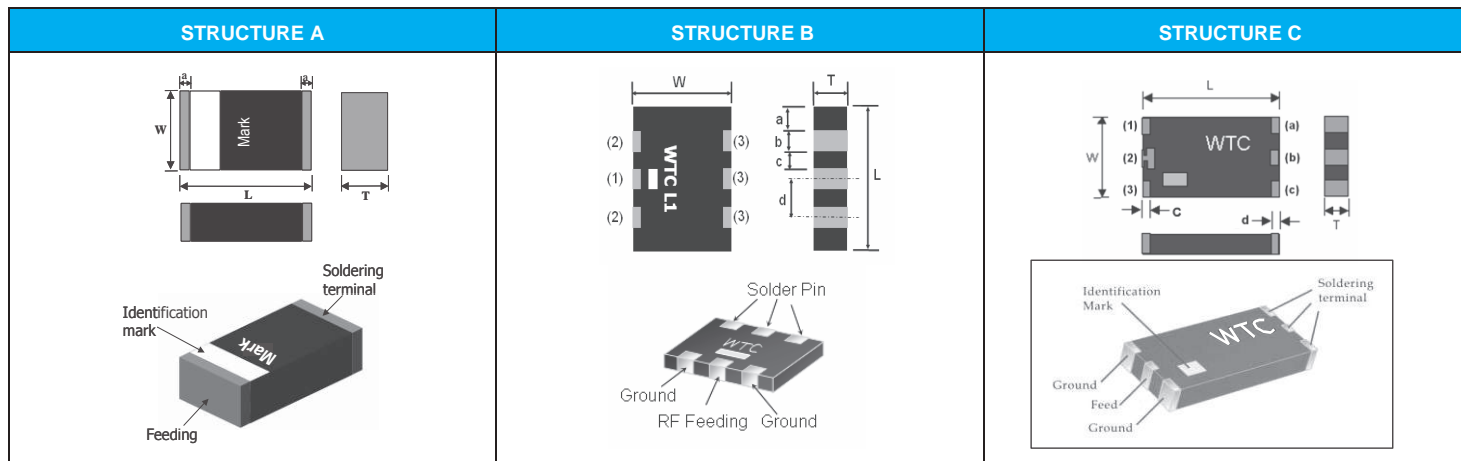

■ STRUCTURE AND DIMENSION

Unit: mm

Structure/Dimension	L	W	T	a	b	c	d	1	2	3
A	10 ± 0.20	3.2 ± 0.20	0.8 ± 0.10	0.8 ± 0.10	-	-	-	-	-	-
	2.0 ± 0.20	1.25 ± 0.20	0.90 ± 0.10	0.25 ± 0.15	-	-	-	-	-	-
	3.20 ± 0.20	1.60 ± 0.20	0.60 ± 0.10	0.25 ± 0.20	-	-	-	-	-	-
			1.20 ± 0.10	0.25 ± 0.15	-	-	-	-	-	-
	5.20 ± 0.20	2.00 ± 0.20	1.30 ± 0.20	0.40 ± 0.20	-	-	-	-	-	-
			1.15 ± 0.10	0.40 ± 0.25	-	-	-	-	-	-
	$5.8 + 0.1 - 0.3$	$3.0 + 0.1 - 0.3$	$1.1 + 0.2 - 0.1$	0.4 ± 0.25	-	-	-	-	-	-
	8.00 ± 0.20	1.05 ± 0.20	0.80 ± 0.10	0.30 ± 0.20	-	-	-	-	-	-
9.10 ± 0.20	3.00 ± 0.20	2.00 ± 0.10	0.20 ± 0.20	-	-	-	-	-	-	
9.50 ± 0.20	2.10 ± 0.20	1.15 ± 0.10	0.50 ± 0.30	-	-	-	-	-	-	
B	5.9 ± 0.3	5.1 ± 0.3	1.1 ± 0.1	0.45 ± 0.2	1.0 ± 0.2	1.0 ± 0.2	2.0 ± 0.2	1.0 ± 0.2	1.0 ± 0.2	1.0 ± 0.2
C	7.6 ± 0.3	3.5 ± 0.2	1.1 ± 0.1	0.8 ± 0.2	0.8 ± 0.2	0.8 ± 0.2	0.5 ± 0.2	0.5 ± 0.2	0.8 ± 0.2	0.50 ± 0.2

Structure/Dimension	L	W	T	PW	P1	P2	P3	P4	P5
D	9.90 ± 0.15	3.70 ± 0.15	3.80 ± 0.20	3.48 ± 0.10	1.4 ± 0.10	1.9 ± 0.10	2.4 ± 0.15	-	-
E	19.0 ± 0.15	3.00 ± 0.15	3.80 ± 0.20	3.00 ± 0.10	1.0 ± 0.10	1.0 ± 0.10	1.0 ± 0.10	1.0 ± 0.10	-
F	12.8 ± 0.15	3.90 ± 0.15	1.10 ± 0.10	1.00 ± 0.10	2.0 ± 0.10	2.0 ± 0.10	2.0 ± 0.10	2.0 ± 0.10	2.0 ± 0.10
G	12.0 ± 0.15	4.00 ± 0.15	2.00 ± 0.10	3.60 ± 0.10	1.0 ± 0.10	1.0 ± 0.10	1.0 ± 0.10	-	-

■ **ELECTRICAL SPECIFICATION**

1.575GHz BAND WORKING FREQUENCY

Part Number	Frequency Range (GHz)	Azimuth Beamwidth (MHz)	Gain (dBi)	VSWR (max.)	Impedance (Ω)	Polarization	Size (mm)	Structure
RFANT5830110E0T	1.575	Omni-directional	0 ~ 2	2.0	50	Linear	5.80x3.00x1.10	A
RFECA1003011E0T	1.575	Omni-directional	2 ~ 3	2.0	50	Linear	10.0x3.20x0.80	A
RFECA3216060E□T	1.575	Omni-directional	3	2.0	50	Linear	3.20x1.60x0.60	A

Bluetooth/WiFi BAND WORKING FREQUENCY

Part Number	Frequency Range (GHz)	Azimuth Beamwidth (MHz)	Gain (dBi)	VSWR (max.)	Impedance (Ω)	Polarization	Size (mm)	Structure
RFECA3216060L1T	2.4~2.5 5.25~5.85	Omni-directional	0.6/2	2.1	50	Linear	3.20x1.60x0.60	A
RFANT6050110L0T	2.4~2.5 4.9~5.9	Omni-directional	4	2.0	50	Linear	5.90x5.10x1.10	B
RFANT6050110L1T	2.4~2.5 4.9~5.9	Omni-directional	4	2.0	50	Linear	5.90x5.10x1.10	B
RFANT2012090A0T	2.4~2.5	Omni-directional	1.72	2.0	50	Linear	2.00x1.25x0.90	A
RFANT3216120A1T	2.4~2.5	Omni-directional	2	2.0	50	Linear	3.20x1.60x1.20	A
RFANT3216120A3T	2.4~2.5	Omni-directional	2	2.0	50	Linear	3.20x1.60x1.20	A
RFANT3216120A5T	2.4~2.5	Omni-directional	2	2.0	50	Linear	3.20x1.60x1.20	A
RFANT5220110A0T	2.4~2.5	Omni-directional	2	2.0	50	Linear	5.20x2.00x1.10	A
RFANT5220110A2T	2.4~2.5	Omni-directional	2	2.0	50	Linear	5.20x2.00x1.10	A
RFANT7635110A1T	2.4~2.5	Omni-directional	0 ~ 2	2.0	50	Linear	7.60x3.50x1.10	C
RFANT8010080A3T	2.4~2.5	Omni-directional	2	2.0	50	Linear	8.00x1.00x0.80	A
RFANT9520120A0T	2.4~2.5	Omni-directional	2	2.0	50	Linear	9.50x2.00x1.20	A
RFECA3216060A1T	2.4~2.5	Omni-directional	2	2.1	50	Linear	3.20x1.60x0.60	A
RFECA3216060K1T	4.9~5.85	Omni-directional	2.8	2.0	50	Linear	3.20x1.60x0.60	A
RFANT9030200A1T	2.4~2.4835	Omni-directional	2	2.1	50	Linear	9.00x 3.00x2.00	A
RGFRA1903041A1T	2.4~2.5	Omni-directional	2	2.0	50	Linear	19.0x3.00x3.80	E
RGFRA1903041A5T	2.4~2.5	Omni-directional	2	2.0	50	Linear	19.0x3.00x3.80	E
RGFRA9937380A3T	2.4~2.55	Omni-directional	2	2.0	50	Linear	9.90x3.70x3.80	D
RGFRA1304011A1T	2.4~2.5	Omni-directional	2	2.1	50	Linear	12.8x3.90x1.10	F
RGFRA1204021A1T	2.4~2.5	Omni-directional	2	2.0	50	Linear	12.0x4.00x2.00	G

WiMAX BAND WORKING FREQUENCY

Part Number	Frequency Range (GHz)	Azimuth Beamwidth (MHz)	Gain (dBi)	VSWR (max.)	Impedance (Ω)	Polarization	Size (mm)	Structure
RFANT32162G6W0T	2.5~2.69	Omni-directional	1	3.0	50	Linear	3.20x1.60x1.20	A
RFANT32163G5W0T	3.3~3.8	Omni-directional	2~3	2.0	50	Linear	3.20x1.60x1.20	A

- For more information, please contact with local sales representative
- All specifications are subject to change without notice

■ **TYPICAL ELECTRICAL CHARACTERISTICS**

RFANT5220110A0T			
Test Board	X-Y Plane Vertical	X-Z Plane Vertical	Y-Z Plane Vertical
	<p>Peak Gain= -5.97dBi Average Gain=-3.12 dBi</p>	<p>Peak Gain= -5.97dBi Average Gain=-3.24 dBi</p>	<p>Peak Gain= 1.69dBi Average Gain=-3.22 dBi</p>
Return Loss (S11)	X-Y Plane Horizontal	X-Z Plane Horizontal	Y-Z Plane Horizontal
	<p>Peak Gain= 2.59dBi Average Gain=-9.24 dBi</p>	<p>Peak Gain= 2.66dBi Average Gain=-8.61 dBi</p>	<p>Peak Gain= -5.42dBi Average Gain=-8.98 dBi</p>
RGFAR1903041A1T			
Test Board	X-Y Plane Vertical	X-Z Plane Vertical	Y-Z Plane Vertical
	<p>Peak Gain= -7.42 dBi Average Gain= -10.48 dBi</p>	<p>Peak Gain= 1.95 dBi Average Gain= -0.81 dBi</p>	<p>Peak Gain= -0.26dBi Average Gain=-5 dBi</p>
Return Loss (S11)	X-Y Plane Horizontal	X-Z Plane Horizontal	Y-Z Plane Horizontal
	<p>Peak Gain= 2.0 dBi Average Gain=-2.31 dBi</p>	<p>Peak Gain= -2.65 dBi Average Gain= -8.4dBi</p>	<p>Peak Gain = 1.11dBi Average Gain = -4.37 dBi</p>

RFANT8010080A3T

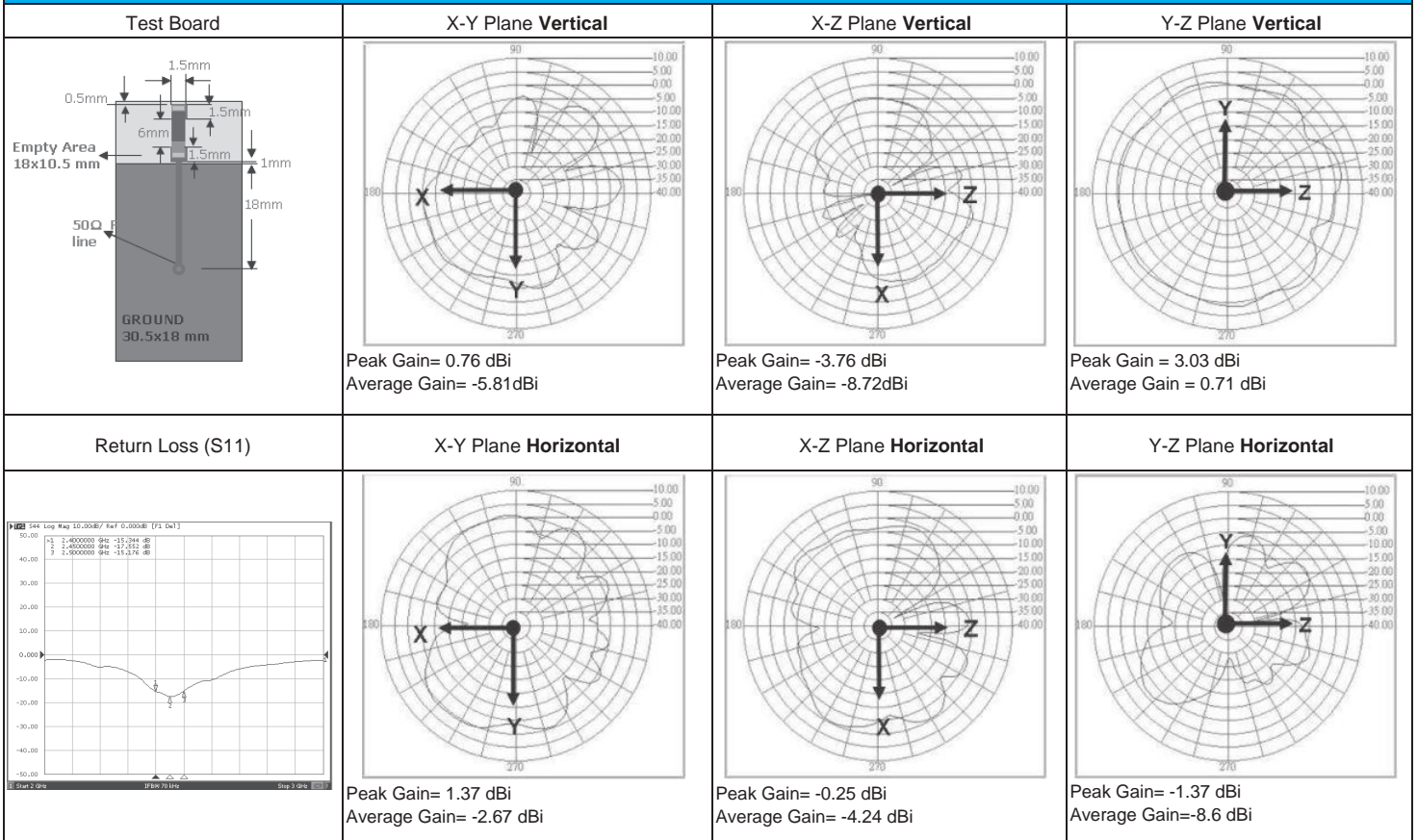

RGFAR9937380A3T

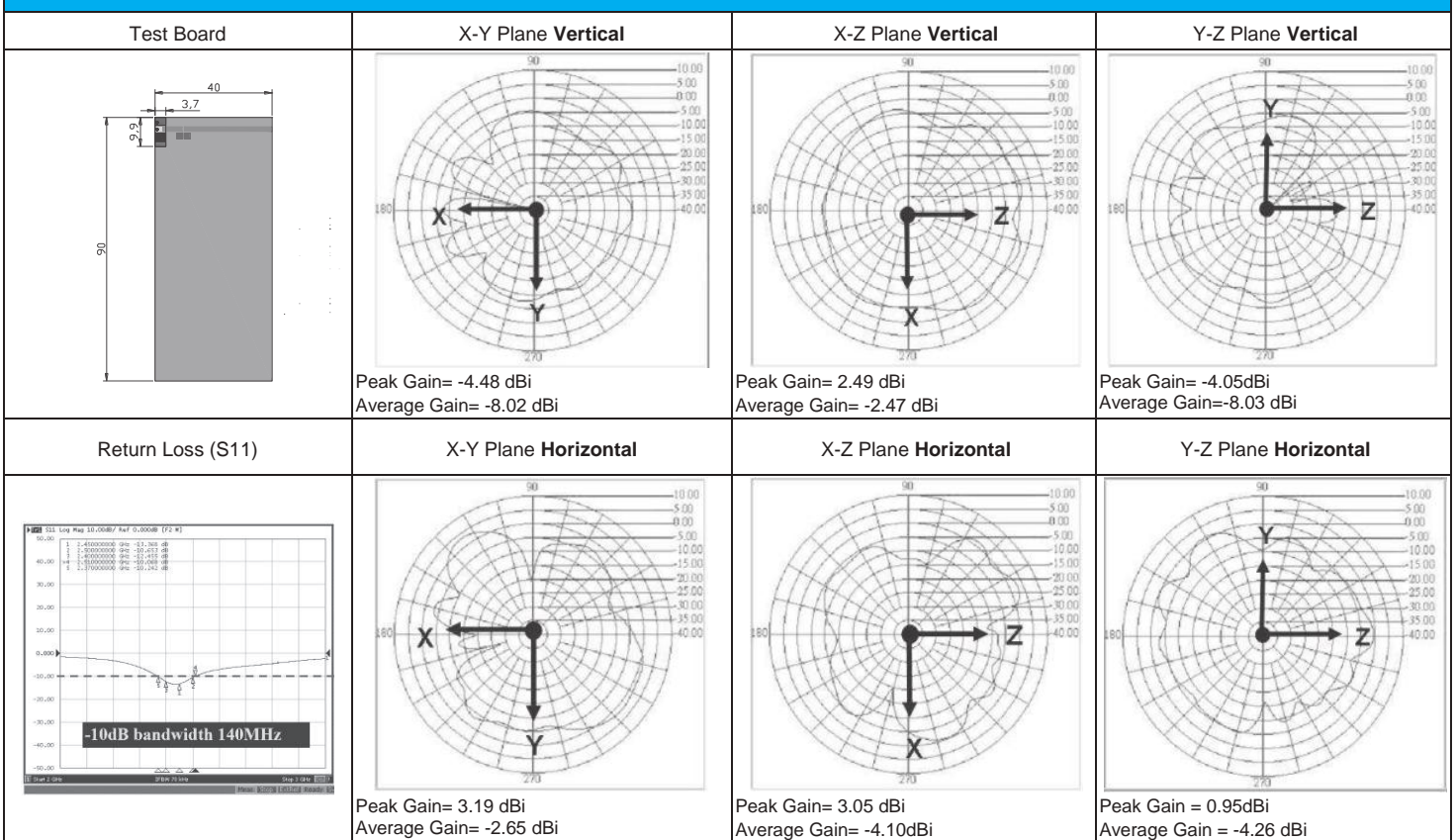

RFCA3216060A1T			
Test Board	X-Y Plane Vertical	X-Z Plane Vertical	Y-Z Plane Vertical
<p>GROUND 90x40mm</p> <p>unit:mm</p>	<p>Peak Gain = 3.37 dBi Average Gain = -0.65 dBi</p>	<p>Peak Gain= 0.83 dBi Average Gain= -1.35 dBi</p>	<p>Peak Gain= -9.59 dBi Average Gain= -15.40 dBi</p>
Return Loss (S11)	X-Y Plane Horizontal	X-Z Plane Horizontal	Y-Z Plane Horizontal
	<p>Peak Gain= -4.62 dBi Average Gain=-10.42 dBi</p>	<p>Peak Gain= 0.51 dBi Average Gain= -4.07 dBi</p>	<p>Peak Gain= 1.39 dBi Average Gain= -2.07 dBi</p>
RFCA1003011E0T			
Antenna S11 on Test Board	X-Y Plane Vertical	X-Z Plane Vertical	Y-Z Plane Vertical
	<p>Peak Gain = 3.12dBi Average Gain = -3.99 dBi</p>	<p>Peak Gain= 1.97dBi Average Gain= -1.44 dBi</p>	<p>Peak Gain = 3.32dBi Average Gain = 1.02 dBi</p>
Antenna VSWR on Test Board	X-Y Plane Horizontal	X-Z Plane Horizontal	Y-Z Plane Horizontal
	<p>Peak Gain = +0.48dBi Average Gain = -4.59dBi</p>	<p>Peak Gain = +4.99dBi Average Gain = -1.31dBi</p>	<p>Peak Gain = +3.02dBi Average Gain = -0.85dBi</p>

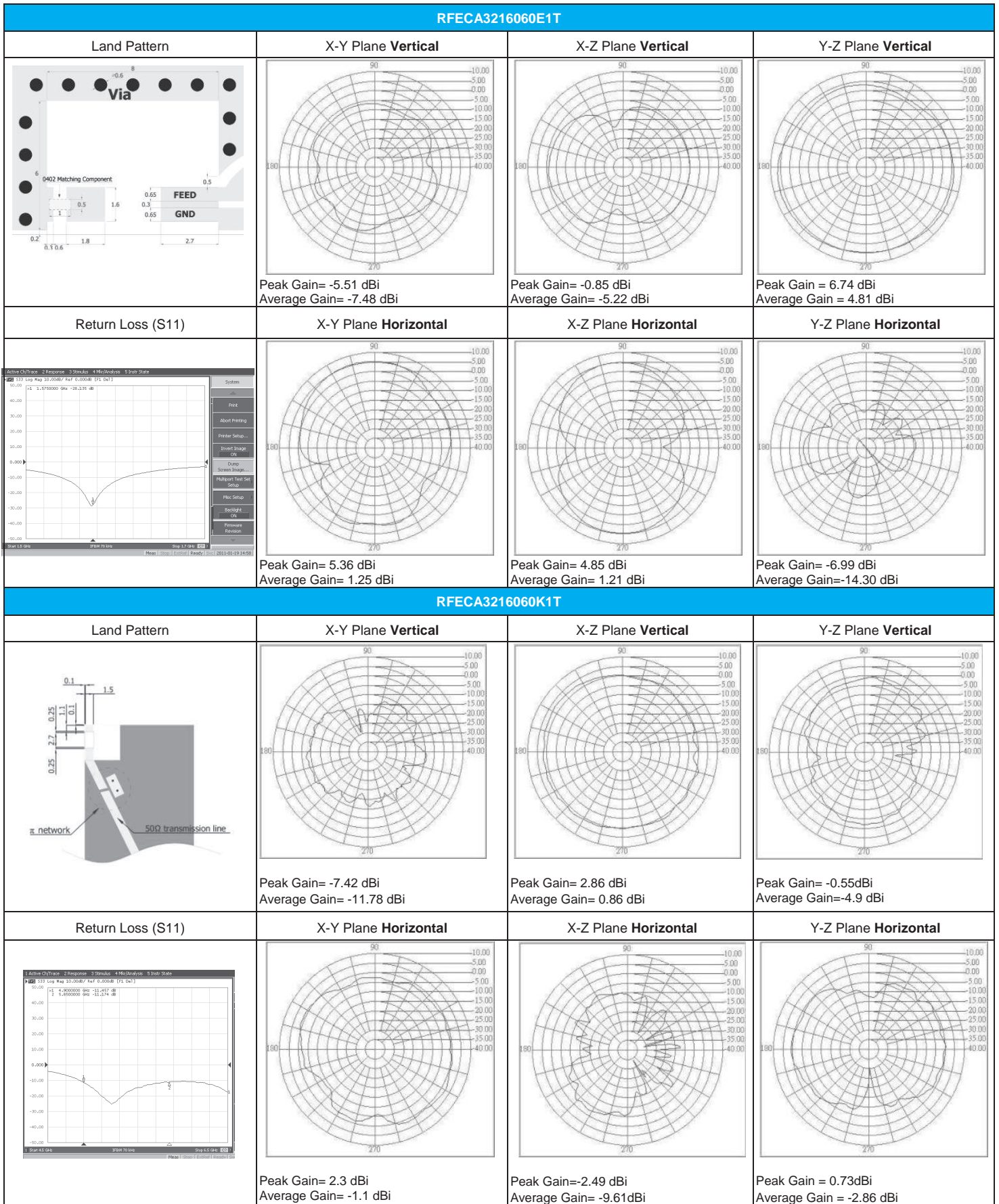

- For more information, please contact with local sales representative
- All specifications are subject to change without notice

HIGH FREQUENCY MULTILAYER BAND PASS FILTER

■ **STRUCTURE AND PIN ASSOCIATED**

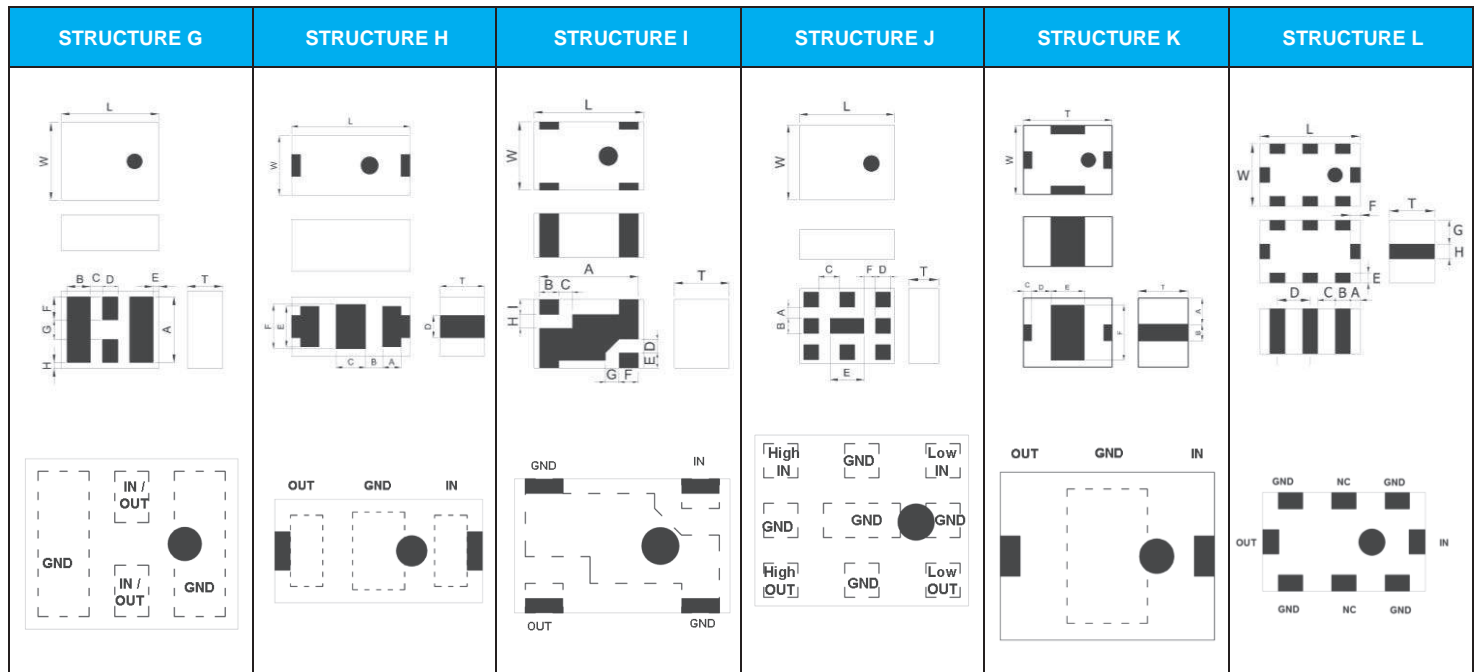
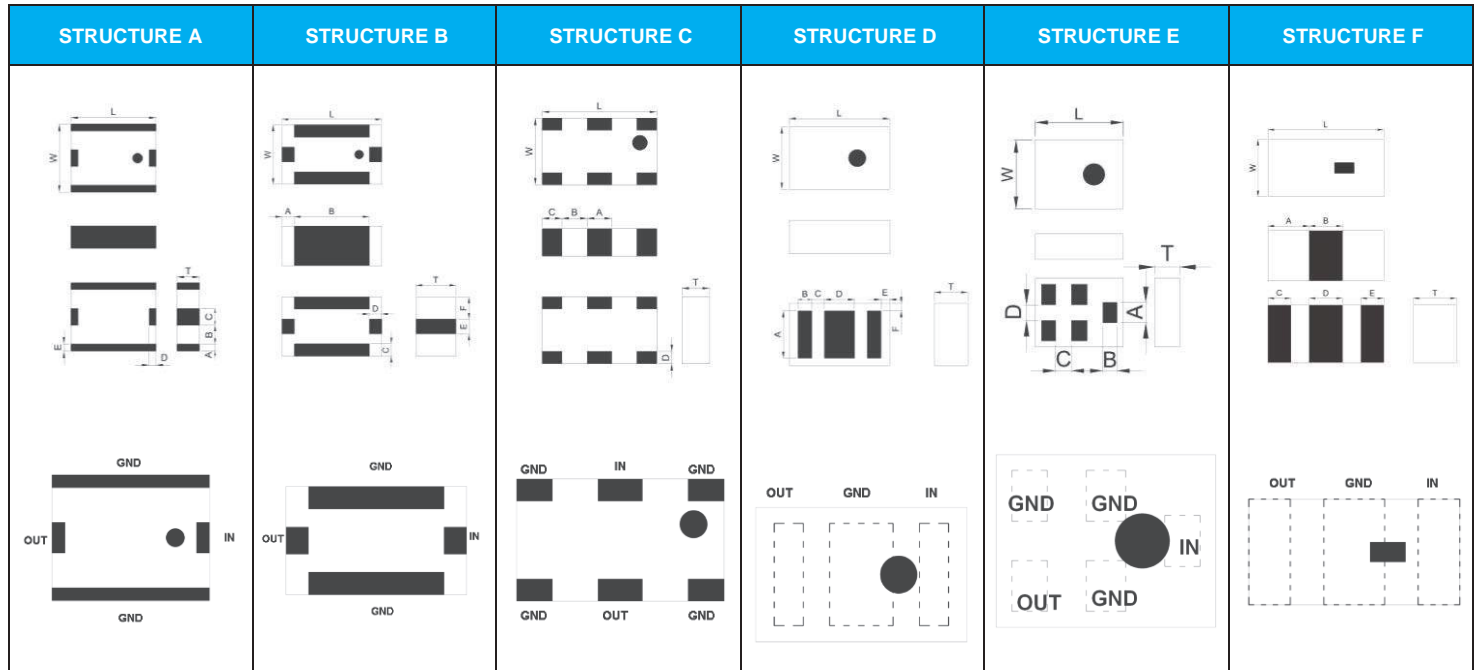

■ **STRUCTURE AND DIMENSION**

Unit: mm

Structure Dimension	L	W	T	A	B	C	D	E	F	G	H	I	
A	2.50±0.20	2.00±0.20	0.70±0.10	0.20±0.20	0.55±0.20	0.50±0.20	0.25±0.20	0.20±0.20	-	-	-	-	
			0.90±0.10	0.20±0.20	0.55±0.20	0.50±0.20	0.20±0.20	0.20±0.20	0.20±0.20	-	-	-	-
			1.00±0.10	0.20±0.20	0.55±0.20	0.50±0.20	0.25±0.20	0.20±0.20	0.20±0.20	-	-	-	-
			1.05±0.10	0.25±0.20	0.50±0.20	0.50±0.20	0.25±0.20	0.25±0.20	0.25±0.20	-	-	-	-
			1.20±0.10	0.25±0.20	0.50±0.20	0.50±0.20	0.25±0.20	0.25±0.20	0.25±0.20	-	-	-	-
	3.20±0.20	2.50±0.10	1.50±0.10	0.20±0.20	0.75±0.20	0.60±0.20	0.20±0.15	0.40±0.20	-	-	-	-	
B	1.00±0.10	0.50±0.10	0.40±0.10	0.35±0.10	0.30±0.10	0.15±0.10	0.15±0.10	0.30±0.10	-	-	-	-	
	1.60±0.15	0.80±0.15	0.50±0.10	0.45±0.15	0.70±0.15	0.20±0.15	0.20±0.15	0.30±0.15	0.25±0.15	-	-	-	
			0.60±0.10	0.45±0.15	0.70±0.15	0.20±0.15	0.20±0.15	0.30±0.15	0.25±0.15	-	-	-	
			0.70±0.10	0.40±0.15	0.80±0.15	0.20±0.10	0.20±0.10	0.30±0.15	0.25±0.15	-	-	-	
			0.70±0.10	0.45±0.15	0.70±0.15	0.20±0.10	0.20±0.10	0.30±0.15	0.25±0.15	-	-	-	
	2.00±0.15	1.20±0.15	0.90±0.10	0.50±0.10	0.40±0.15	0.80±0.15	0.20±0.10	0.20±0.10	0.30±0.15	0.45±0.15	-	-	-
				0.20±0.15	1.60±0.15	0.20±0.15	0.20±0.15	0.40±0.15	0.40±0.15	-	-	-	
				0.20±0.15	1.60±0.15	0.25±0.15	0.25±0.15	0.30±0.15	0.45±0.15	-	-	-	
				0.45±0.15	1.10±0.15	0.25±0.15	0.25±0.15	0.30±0.15	0.45±0.15	-	-	-	
		1.25±0.15	0.60±0.10	0.50±0.15	1.00±0.15	0.25±0.15	0.25±0.15	0.30±0.15	0.475±0.15	-	-	-	
					0.80±0.10	0.50±0.15	1.00±0.15	0.25±0.15	0.25±0.15	0.30±0.15	0.475±0.15	-	-
					0.90±0.10	0.50±0.15	1.00±0.15	0.25±0.15	0.25±0.15	0.30±0.15	0.475±0.15	-	-
					0.35±0.15	1.30±0.15	0.20±0.15	0.20±0.15	0.30±0.15	0.475±0.15	-	-	-
					0.95±0.10	0.35±0.15	1.30±0.15	0.25±0.15	0.25±0.15	0.30±0.15	0.475±0.15	-	-
0.50±0.15					1.00±0.15	0.25±0.15	0.25±0.15	0.30±0.15	0.475±0.15	-	-		
C	2.00±0.15	1.20±0.20	0.55±0.10	0.40±0.20	0.40±0.20	0.40±0.20	0.20±0.10	-	-	-	-		
			0.60±0.10	0.40±0.20	0.40±0.20	0.40±0.20	0.20±0.10	-	-	-			
			0.80±0.10	0.40±0.20	0.40±0.20	0.40±0.20	0.20±0.10	-	-	-			
D	1.60±0.15	0.80±0.15	0.60±0.10	0.55±0.10	0.25±0.10	0.23±0.10	0.40±0.10	0.12±0.10	0.125±0.10	-	-		
	2.00±0.15	1.25±0.10	0.45±0.10	0.95±0.10	0.275±0.10	0.25±0.10	0.60±0.10	0.175±0.10	0.15±0.10	-	-		
			0.70 max	0.95±0.10	0.275±0.10	0.25±0.10	0.60±0.10	0.175±0.10	0.15±0.10	-	-		
			0.80±0.10	0.95±0.10	0.275±0.10	0.25±0.10	0.60±0.10	0.175±0.10	0.15±0.10	-	-		
E	1.10±0.10	0.90±0.10	0.60±0.10	0.25±0.10	0.18±0.10	0.205±0.10	0.25±0.10	-	-	-	-		
	1.40±0.15	1.10±0.10	0.60±0.10	0.325±0.10	0.25±0.10	0.25±0.10	0.25±0.10	-	-	-	-		
	1.40±0.15	1.10±0.15	0.70±0.10	0.325±0.10	0.25±0.10	0.25±0.10	0.25±0.10	-	-	-	-		
	2.00±0.20	1.25±0.20	1.00 max.	0.325±0.10	0.25±0.10	0.25±0.10	0.25±0.10	-	-	-	-		
F	1.60±0.15	0.80±0.15	0.40±0.10	0.55±0.15	0.50±0.15	0.35±0.15	0.50±0.15	0.20±0.15	-	-	-		
			0.60±0.10	0.55±0.15	0.50±0.15	0.35±0.15	0.50±0.15	0.20±0.15	-	-	-		
G	1.60±0.10	0.80±0.10	0.70 max.	0.55±0.10	0.25±0.10	0.23±0.10	0.40±0.10	0.12±0.10	0.195±0.10	0.21±0.10	0.125±0.10	-	
	2.00±0.15	1.25±0.10	0.80±0.10	0.95±0.10	0.40±0.10	0.30±0.10	0.30±0.10	0.15±0.10	0.30±0.10	0.35±0.10	0.15±0.10	-	
			0.90±0.10	0.95±0.10	0.40±0.10	0.30±0.10	0.30±0.10	0.15±0.10	0.30±0.10	0.35±0.10	0.15±0.10	-	
2.50±0.20	2.00±0.20	0.90±0.10	1.70±0.20	0.60±0.20	0.30±0.20	0.40±0.20	0.15±0.10	0.60±0.10	0.50±0.10	0.15±0.10	-		
H	1.60±0.15	0.80±0.10	0.60 max.	0.25±0.10	0.23±0.05	0.40±0.10	0.30±0.10	0.55±0.10	0.60±0.10	-	-	-	
I	2.00±0.15	1.25±0.10	1.00 max.	1.80±0.10	0.35±0.10	0.25±0.10	0.25±0.10	0.275±0.10	0.35±0.10	0.25±0.10	0.25±0.10	0.275±0.10	
J	2.50±0.15	2.00±0.15	0.90±0.10	0.30±0.10	0.40±0.10	0.55±0.10	0.40±0.10	0.90±0.10	0.30±0.10	-	-	-	
K	2.00±0.15	1.25±0.15	1.05±0.15	0.475±0.15	0.30±0.15	0.20±0.15	0.50±0.15	0.60±0.15	0.95±0.15	-	-	-	
	3.20±0.20	2.50±0.20	1.80±0.20	0.95±0.20	0.60±0.20	0.30±0.15	0.70±0.15	1.20±0.15	2.00±0.15	-	-	-	
L	2.00±0.15	1.25±0.10	1.05 max.	0.20±0.10	0.35±0.10	0.30±0.10	0.65±0.10	0.20±0.10	0.20±0.10	0.475±0.10	0.30±0.10	-	

■ ELECTRICAL SPECIFICATION

2.4GHz BAND WORKING FREQUENCY

Part Number	Frequency Range(GHz)	Insertion Loss (dB)	Attenuation (dB min.)	VSWR (max.)	Impedance (Ω)	Size(mm)	STRUCTURE
RBBPF1005040A1T	2.4~2.5	2.5	25(824~960MHz) 20(1710~1910MHz) 20(4800~5000MHz) 15(7200~7500MHz)	2.0	50	1.00x0.50x0.40	B
RFBPF1005040A3T	2.4~2.5	1.5max.(25°C) 1.7max.(-40~+85°C)	13(824~915MHz) 5(1545~1605MHz) 34(4800~5000MHz) 27(7200~7500MHz)	2.1	50	1.00x0.50x0.40	B
RFBPF1109060A0T	2.4~2.5	1.8	35(824~960MHz) 38(1545~1605MHz) 20(1710~1990MHz) 8(2110~2170MHz) 35(3600MHz) 35(4800~5000MHz) 35(7200~7500MHz)	2.0	50	1.10x 0.90x0.60	E
RFBPF1411060A1T	2.4~2.5	1.8max.(25°C) 2.1max.(-40~+85°C)	40(824~960MHz) 40(1545~1605MHz) 20(1710~1990MHz) 8(2110~2170MHz) 35(3600MHz) 35(4800~5000MHz) 35(7200~7500MHz)	2.0	50	1.40x1.10x0.60	E
RFBPF1411060A2T	2.4~2.5	1.5	30(500~960MHz) 25(1500~1650MHz) 19(3200~3300MHz) 40(4800~5000MHz) 30(7200~7500MHz)	2.0	50	1.40x1.10x0.60	E
RBBPF1411060A3T	2.4~2.5	1.1	20(50~960MHz) 10(1710~1990MHz) 9(3600MHz) 22(4800~7200MHz)	2.0	50	1.40x1.10x0.60	E
RBBPF1411060A8T	2.4~2.5	1.0max.(25°C) 1.2max.(-40~+85°C)	15(50~960MHz) 10(1710~1990MHz) 15(3600MHz) 25(4800~7200MHz)	2.0	50	1.40x1.10x0.60	E
RFBPF1608060AA7M1U	2.4~2.5	0.95max.(25°C) 1.25max.(-40~+85°C)	20(500~960MHz) 23(3200MHz) 30(4800~5000MHz) 32(7200~7500MHz)	2.0	50	1.60x0.80x0.60	H
RFBPF1608060ADT	2.4~2.5	1.8max.(25°C) 2.1max.(-40~+85°C)	25(800~1000MHz) 22.5(1200~1300MHz) 5.5(2000MHz) 10.5(3000MHz) 23.5(3600~3800MHz) 35(4800~5000MHz) 35(7200~7500MHz)	2.0	50	1.60x0.80x0.60	B
RFBPF1608060AET	2.4~2.5	1.7max.(25°C) 2.0max.(-40~+85°C)	25(880MHz) 20(3200MHz) 35(4800~5000MHz) 25(7200~7500MHz)	2.0	50	1.60x0.80x0.60	F
RFBPF1608070AFT	2.4~2.5	2.4max.(25°C) 2.7max.(-40~+85°C)	24.5(880~960MHz) 20(1710~1990MHz) 8.5(2170MHz) 15(4800~5000MHz) 20(7200~7500MHz)	2.0	50	1.60x0.80x0.70	B
RFBPF1608070AWT	2.4~2.5	2.0max.(25°C) 2.2max.(-40~+85°C)	30(960MHz) 25(1910MHz) 20(1990MHz) 25(4800MHz) 15(7200MHz)	2.0	50	1.60x0.80x0.70	B
RFBPF1608050A0T	2.4~2.5	2.0max.(25°C) 2.2max.(-40~+85°C)	20(960MHz) 20(1910MHz) 15(1990MHz) 18(4800MHz) 25(7200MHz)	2.0	50	1.60x0.80x0.50	B
RFBPF1608060A1T	2.4~2.5	2.8	25(695~800MHz) 20(1910MHz) 35(3200MHz) 20(4800~5000MHz) 20(7200~7500MHz)	2.0	50	1.60x0.80x0.60	B
RFBPF1608060A7T	2.4~2.5	3.0	25(695~800MHz) 20(1910MHz) 35(3200MHz) 20(4800~5000MHz) 20(7200~7500MHz)	2.0	50	1.60x0.80x0.60	B
RFBPF1608060A8T	2.4~2.5	1.7	30(880~915MHz) 30(1710~1785MHz) 25(1850~1910MHz) 25(4800~5000MHz) 15(7200~7500MHz)	2.0	50	1.60x0.80x0.60	B

2.4GHz BAND WORKING FREQUENCY

Part Number	Frequency Range(GHz)	Insertion Loss (dB)	Attenuation (dB min.)	VSWR (max.)	Impedance (Ω)	Size(mm)	STRUCTURE
RFBPF1608070A3T	2.4~2.5	1.8max.(25°C) 2.1max.(-40~+85°C)	27(800~900MHz) 25(4800~5000MHz) 30(7200~7500MHz)	2.0	50	1.60x0.80x0.70	B
RFBPF2012080AM0T62	2.4~2.5	1.8max.(25°C) 2.0max.(-40~+85°C)	30(860~960MHz) 30(1545~1605MHz) 35(1710~1990MHz) 30(2170MHz) 30(4800~5000MHz)	2.0	50	2.00x1.20x0.80	D
RFBPF2012080AC2T00	2.4~2.5	1.35max.(25°C) 1.55max.(-40~+85°C)	30(804~828MHz) 20(1608~1656MHz) 30(3216~3312MHz) 40(4020~4140MHz) 20(4824~4968MHz) 20(5628~5796MHz) 20(6432~6624MHz) 35(7200~7500MHz) 20(7500~10000MHz)	2.0	50	2.00x1.25x0.80	G
RFBPF2012090AS1T35	2.4~2.5	0.9max.(25°C) 1.1max.(-40~+85°C)	28(824~960MHz) 30(1570~1580MHz) 15(1710~1910MHz) 9.5(1910~1990MHz) 25(4800~5000MHz) 25(7200~7500MHz)	2.0	50	2.00x1.25x0.90	G
RFBPF2012060AAT	2.4~2.5	1.5max.(25°C) 1.8max.(-40~+85°C)	30(880~960MHz) 25(1710~1910MHz) 25(4800~5000MHz) 30(7200~7500MHz)	2.0	50	2.00x1.20x0.60	C
RFBPF2012040ABT	2.4~2.5	2.5	30(824~849MHz) 30(880~915MHz) 30(1545~1605MHz) 30(1565~1585MHz) 35(1710~1785MHz) 40(1850~1910MHz) 32(1920~1980MHz) 7(3168~4752MHz) 11(3300~3800MHz) 35(4800~4967MHz) 26(5150~6000MHz) 23(7200~7450MHz)	2.0	50	2.00x1.20x0.40	D
RFBPF2012050ACT	2.4~2.5	2.5	35(824~960MHz) 38(1710~1910MHz) 25(4880~5000MHz) 20(7200~7500MHz)	2.0	50	2.00x1.20x0.55	C
RFBPF2012080ADT	2.4~2.5	1.5max.(25°C) 1.7max.(-40~+85°C)	30(860~960MHz) 30(1545~1605MHz) 30(1710~1990MHz) 30(2170MHz) 30(4800~5000MHz)	2.0	50	2.00x1.25x0.80	D
RFBPF2012080AFT	2.4~2.5	1.8max.(25°C) 2.0max.(-40~+85°C)	30(824~915MHz) 30(1545~1605MHz) 35(1710~1990MHz) 30(2170MHz) 30(4800~4967MHz) 25(5150~6000MHz) 20(7200~7450.5MHz)	2.0	50	2.00x1.25x0.80	D
RFBPF2012080AGT	2.4~2.5	1.8max.(typ.1.5)	35(824~960MHz) 28(1545~1605MHz) 30(1710~1990MHz) 30(2170MHz) 6(3200MHz) 30(4800~4967MHz) 20(5150~6000MHz) 18(7200~7450MHz)	2.0	50	2.00x1.25x0.80	D
RFBPF2012040AHT	2.4~2.5	2.5	25(746~764MHz) 30(824~849MHz) 26(869~960MHz) 28(1570~1580MHz) 28(1710~1785MHz) 30(1850~1910MHz) 30(1930~1990MHz) 30(2110~2170MHz) 15(3300~3800MHz) 35(4800~5000MHz) 20(7200~7450.5MHz)	2.0	50	2.00x1.25x0.45	D
RBBPF2012050AHT	2.4~2.5	2.5max.(typ.2.2)	25(746~764MHz) 30(824~849MHz) 26(869~960MHz) 28(1570~1580MHz) 28(1710~1785MHz) 30(1850~1910MHz) 30(1930~1990MHz) 25(2110~2170MHz) 15(3300~3800MHz) 35(4800~5000MHz)	2.0	50	2.00x1.25x0.45	D

2.4GHz BAND WORKING FREQUENCY

Part Number	Frequency Range(GHz)	Insertion Loss (dB)	Attenuation (dB min.)	VSWR (max.)	Impedance (Ω)	Size(mm)	STRUCTURE
RFBPF2012090ALT	2.4~2.5	1.0max.(25°C) 1.2max.(-40~+85°C)	28(824~960MHz) 28(1570~1580MHz) 23(1710~1910MHz) 17(1920~1990MHz) 25(4800~5000MHz)	2.0	50	2.00x1.25x0.90	G
RFBPF2012090AMT	2.4~2.5	2.6	40(880~960MHz) 38(1710~1990MHz) 16(2170MHz) 30(4800~5000MHz) 30(7200~7500MHz)	2.0	50	2.00x1.20x0.90	B
RFBPF2012100ANT	2.4~2.5	2.3max.(25°C) 2.6max.(-40~+85°C)	40(699~960MHz) 40(1428~1448MHz) 40(1476~1607MHz) 40(1710~1785MHz) 33(1805~1880MHz) 30(1880~1915MHz) 30(1920~1990MHz) 22(2110~2170MHz) 25(4800~5000MHz) 35(7200~7500MHz)	2.0	50	2.00x1.20x1.00	I
RFBPF2012090AQT	2.4~2.5	1.2	20(1600MHz) 25(3200MHz) 20(4800~5000MHz)	2.0	50	2.00x1.20x0.90	B
RFBPF2012090ART	2.4~2.5	1.0	20(1600MHz) 25(3200MHz)	2.0	50	2.00x1.20x0.90	B
RFBPF2012100AVT	2.4~2.5	1.5max.(25°C) 1.7max.(-40~+85°C)	40(699~960MHz) 40(1428~1448MHz) 40(1476~1607MHz) 40(1710~1785MHz) 33(1805~1880MHz) 30(1880~1915MHz) 30(1920~1990MHz) 25(4800~5000MHz) 30(7200~7500MHz)	2.0	50	2.00x1.20x1.00	I
RBBPF2010A108Q1C	2.4~2.5	1.3max.(25°C) 1.5max.(-40~+85°C)	38(50~960MHz) 17(1710~1910MHz) 5(3200MHz) 30(4800~5000MHz) 25(7200~7500MHz)	2.0	50	2.00x1.20x0.90	E
RFBPF2009A12T	2.4~2.5	1.0max.(25°C) 1.2max.(-40~+85°C)	28(824~960MHz) 28(1570~1580MHz) 23(1710~1910MHz) 17(1920~1990MHz) 4(2100~2170MHz) 25(4800~5000MHz) 25(7200~7500MHz)	2.0	50	2.00x1.25x0.90	G
RBBPF2010A16T	2.4~2.5	1.3max.(25°C) 1.5max.(-40~+85°C)	38(50~960MHz) 17(1710~1990MHz) 20(3200MHz) 30(4800~5000MHz) 25(7200~7500MHz)	2.0	50	2.00x1.25x1.00	E
AMBPF2008A17T	2.4~2.5	1.35max.(25°C) 1.65max.(-40~+125°C)	30(804~828MHz) 20(1608~1656MHz) 30(3216~3312MHz) 38(4020~4140MHz) 20(4824~4968MHz) 20(5628~5796MHz) 20(6432~6624MHz) 35(7200~7500MHz) 20(7500~10000MHz)	2.0	50	2.00x1.20x0.80	G
RFBPF2012090A1T	2.4~2.5	1.7max.(25°C) 1.9max.(-40~+85°C)	30(900MHz) 20(1850MHz) 30(4800MHz)	2.0	50	2.00x1.20x0.90	B
RFBPF2012090A2T	2.4~2.5	1.4max.(25°C) 1.6max.(-40~+85°C)	30(824~960MHz) 30(1710~1910MHz) 20(1920~1990MHz) 6(2110~2170MHz) 20(4800~5000MHz)	2.0	50	2.00x1.20x0.90	B
RFBPF2012040A3T	2.4~2.5	2.0max.(25°C) 2.2max.(-40~+85°C)	25(746~764MHz) 30(824~849MHz) 26(869~960MHz) 28(1570~1580MHz) 28(1710~1785MHz) 30(1850~1910MHz) 30(1930~1990MHz) 25(2110~2170MHz) 15(3300~3800MHz) 35(4800~5000MHz) 20(7200~7450.5MHz)	2.0	50	2.00x1.25x0.45	D

2.4GHz BAND WORKING FREQUENCY

Part Number	Frequency Range(GHz)	Insertion Loss (dB)	Attenuation (dB min.)	VSWR (max.)	Impedance (Ω)	Size(mm)	STRUCTURE
RFBPF2012080A6T	2.4~2.5	3.5	30(880~960MHz) 30(1710~1990MHz) 20(2110~2170MHz) 30(4800~5000MHz) 30(7200~7500MHz)	2.0	50	2.00x1.20x0.80	C
RFBPF2012100A6T	2.4~2.5	1.0max.(25°C) 1.2max.(-40~+85°C)	21(902~928MHz) 26(4800~5000MHz) 34(7200~7500MHz) 29(9600~10000MHz)	2.0	50	2.00x1.20x1.00	L
RFBPF2012080A7T	2.4~2.5	2.8 (typ.2.5)	40(DC~1600MHz) 35(1710MHz) 25(1900MHz) 12(2100MHz) 8(2170MHz) 30(3100MHz) 40(4800~5000MHz) 20(7200~7500MHz)	2.0	50	2.00x1.20x0.80	B
RFBPF2012060A9T	2.4~2.5	2.8	30(960MHz) 30(1600MHz) 20(1990MHz) 35(3200MHz) 40(4800MHz) 25(7200MHz)	2.0	50	2.00x1.20x0.60	B
RFBPF2520090ACT	2.4~2.5	2.1max.(25°C) 2.3max.(-40~+85°C)	43(806~960MHz) 43(1570~1580MHz) 43(1710~1990MHz) 20(2110~2170MHz) 30(4800~5000MHz) 25(7200~7500MHz)	2.0	50	2.50x2.00x0.90	G
RFBPF2520070AMT	2.4~2.5	2.0max.(25°C) 2.2max.(-40~+85°C)	45(824~960MHz) 45(1570~1580MHz) 45(1710~1785MHz) 40(1805~1850MHz) 35(1850~1910MHz) 35(1920~1990MHz) 25(2110~2170MHz) 5(2750~3000MHz) 15(3000~4800MHz) 30(4800~5000MHz) 30(5150~5850MHz) 20(7200~7500MHz)	2.0	50	2.50x2.00x0.70	A
RFBPF2520080AUT	2.4~2.5	2.2	30(900MHz) 30(1850MHz) 33(2170MHz) 35(4800MHz) 25(7200MHz)	2.0	50	2.50x2.00x0.70	A
RFBPF2520120A1T	2.4~2.5	1.7	30(900MHz) 30(1850MHz) 20(2100MHz) 40(4800MHz) 25(7200MHz)	2.0	50	2.50x2.00x1.20	A
RFBPF2520120A2T	2.4~2.5	2.1	30(900MHz) 30(1850MHz) 30(4800MHz)	2.0	50	2.50x2.00x1.20	A
RFBPF2520120A3T	2.4~2.5	≤1.2(25°C)	30(900MHz) 30(1850MHz) 25(4800MHz)	2.0	50	2.50x2.00x1.20	A
RFBPF2520120A4T	2.4~2.5	≤1.7(25°C)	30(900MHz) 30(1850MHz) 25(4800MHz)	2.0	50	2.50x2.00x1.20	A
RFBPF2520100A6T	2.4~2.5	1.4	35(1900/4800 MHz)	2.0	50	2.50x2.00x1.00	A
RFBPF3225150A3T	2.4~2.5	2.5	40(1500MHz) 30(2100MHz) 30(4800MHz)	1.7	-	3.20x2.50x1.50	A
RFBPF3225150A4T	2.4~2.5	2.0	30(900MHz) 30(1850MHz) 20(2100MHz) 30(4800MHz)	2.0	50	3.20x2.50x1.50	A
RFBPF3225150A5T	2.4~2.5	1.8	30(900MHz) 30(1850MHz) 20(2100MHz) 30(4800MHz)	2.0	50	3.20x2.50x1.50	A

5GHz BAND WORKING FREQUENCY

Part Number	Frequency Range(GHz)	Insertion Loss (dB)	Attenuation (dB min.)	VSWR (max.)	Impedance (Ω)	Size(mm)	STRUCTURE
RFBPF1608060K2T	4.9~5.84	1.5max.(25°C) 1.7max.(-40~+85°C)	33(100~2170MHz) 29(2170~2500MHz) 32(9800~12000MHz)	2.0	50	1.60x0.80x0.70	B
RFBPF1608060K68Q1C	4.9~5.9	1.3max.(25°C) 1.5max.(-40~+85°C)	38(30~2700MHz) 16(3453~3547MHz) 33(3667~3883MHz) 9(6900~7093MHz) 32(7333~7750MHz) 40(10600~11650MHz) 18(15540~17760MHz)	2.0	50	1.60x0.80x0.60	D
RFBPF1608060K78Q1C	5.15~5.95	0.8max.(25°C) 1.0max.(-40~+85°C)	40(30~2700MHz) 45(3400~3800MHz) 20(7250~7800MHz) 20(10300~11700MHz)	1.5	50	1.60x0.80x0.60	D
RFBPF1608060K88Q1C	5.15~5.95	0.7max.(25°C) 0.85max.(-40~+85°C)	35(30~2700MHz) 30(3400~3800MHz) 12(7250~7800MHz) 20(10300~11700MHz)	1.5	50	1.60x0.80x0.60	D
RFBPF1608060KG8D1T	5.15~5.95	0.8	40(30~2700MHz) 45(3400~3800MHz) 20(6900MHz) 20(7250~7800MHz) 20(10300~11700MHz)	1.67	50	1.60x0.80x0.60	D
RFBPF2012100KST	4.9~5.9	1.5(4.90GHz) 1.5(5.25GHz) 1.5(5.85GHz)	30(3450MHz) 20(11000MHz)	2.0	50	2.00x1.20x1.00	B
RFBPF2012100K0T	4.9~5.9	1.7(4.90GHz) 1.5(5.25GHz) 1.5(5.85GHz)	30(3450MHz) 20(11000MHz)	2.0	50	2.00x1.20x1.00	B
RFBPF2012090K5T	4.9~5.85	2.2max.(25°C) 2.5max.(-40~+85°C)	35(340~1195MHz) 19(2140~3580MHz) 25(6855~7150MHz) 20(8570~8930MHz)	2.0	50	2.00x1.20x0.90	B
RFBPF2012100K3T	4.9~5.85	1.8max.(25°C) 2.1max.(-40~+85°C)	30(500MHz) 35(3450MHz) 30(4000MHz) 20(4200MHz) 15(9800MHz) 15(11700MHz)	2.0	50	2.00x1.20x0.95	B
RFBPF2012100K6T	5.15~5.85	1.6max.(25°C) 1.8max.(-40~+85°C)	30(500MHz) 40(2000MHz) 35(3450MHz) 30(4000MHz) 20(4200MHz)	2.0	50	2.00x1.20x0.95	B
RFBPF2012090K9T	5.725~5.85	2.0	30(500MHz) 30(4000MHz) 20(4200MHz) 32(5000MHz) 15(9800MHz) 15(11750MHz)	2.0	50	2.00x1.20x0.95	B
RFBPF2520090K1T	4.9~5.85	1.2max.(25°C) 1.5max.(-40~+85°C)	50(824~1910MHz) 15(9880~11700MHz)	2.0	50	2.50x2.00x0.90	A
KFBPF25204G7W09S5K	4.4~4.94	3.5	50(1000MHz) 35(2500MHz) 20(3500MHz) 7(4250MHz) 15(5150MHz) 20(57500MHz)	2.0	50	2.50x2.00x0.80	A

WiMAX BAND WORKING FREQUENCY

Part Number	Frequency Range(GHz)	Insertion Loss (dB)	Attenuation (dB min.)	VSWR (max.)	Impedance (Ω)	Size(mm)	STRUCTURE
RFBPF16082G3W0T	2.3~2.39	2.0	29(880~915MHz) 29(1710~1785MHz) 21(1850~1910MHz) 15(1920~1980MHz) 18(4600~4780MHz) 23(6900~7170MHz)	2.0	50	1.60x0.80x0.70	B

1558 ~ 1606 MHz GNSS Band Applications

Part Number	Frequency Range (MHz)	Insertion Loss (dB)	Attenuation (dB min.)	VSWR (max.)	Impedance (Ω)	Size(mm)	STRUCTURE
RFBPF1109060E0T	1550~1610	1.9max.	25(960MHz) 8(1850MHz) 15(1990MHz) 20(2170MHz) 35(2400~2500MHz) 35(3400~3800MHz)	2.0	50	1.10x0.90x0.60	E
RFBPF1411070E0T	1558~1606	1.8max.(25°C) 2.0max.(-40~+85°C)	30(824~849MHz) 30(880~915MHz) 10(1880~1910MHz) 22(1920~1980MHz) 30(2400MHz)	2.0	50	1.40x1.10x0.70	E

860~960MHz/1805~2025 MHz Band Application

Part Number	Frequency Range (MHz)	Insertion Loss (dB)	Attenuation (dB min.)	VSWR (max.)	Impedance (Ω)	Size(mm)	STRUCTURE
RFBPF2520090B08Q1C	869~960	0.7max.(25°C) 0.75max.(-40~+85°C)	25(430~490MHz) 10(1700~1900MHz) 20(2400~2500MHz) 20(4905~5845MHz)	1.9	50	2.50x2.00x0.90	J
	1805~2025	1.1max.(25°C) 1.2max.(-40~+85°C)	25(900~1015MHz) 15(2400~2500MHz) 15(3610~3980MHz) 20(4905~5845MHz)	2.0			

MoCA / Docsis Application

Part Number	Frequency Range(MHz)	Insertion Loss (dB)	Attenuation (dB min.)	VSWR (max.)	Impedance (Ω)	Size(mm)	STRUCTURE
RFBPF3225180Y1T	975~1025	3.0	30(54~870MHz) 30(1125~1675MHz) 30(2300MHz)	2.0	75	3.20x2.50x1.80	K
RFBPF3225200Y07B1U	475~675	2.5max.(25°C) 2.7max.(-40~+85°C)	60(2.5MHz) 40(2.5~100MHz) 35(100~200MHz) 35(200~300MHz) 8(300~400MHz) 57(950MHz) 47(950~2025MHz) 41(2025~2500MHz) 35(2500~3000MHz)	2.0	75	3.20x2.50x1.80	K
RBBPF3225180Y27B1U	400~700	2.0	42(1~200MHz) 30(950~2150MHz) 35(2150~3000MHz) 27(3000~5900MHz)	2.0	50	3.20x2.50x1.80	K
KFBPF2012100C67B1U	1125~1675	2.5	35(1~900MHz) 20(900~1002MHz) 35(2000~2500MHz) 20(2500~5900MHz)	2.0	50	2.00x1.25x1.05	K
RFBPF3225180C07B1U	1125~1675	1.8max.(25°C) 2.0max.(-40~+85°C)	30(5~864MHz) 34(864~1002MHz) 32(2300~3000MHz)	2.0	75	3.20x2.50x1.80	K
RBBPF3225180C67B1U	1125~1675	2.0	40(1~900MHz) 25(900~1002MHz) 35(2000~2500MHz) 27(2500~5900MHz)	2.0	50	3.20x2.50x1.80	K
RBBPF3225180C77B1U	1125~1225	2.0	33(1~900MHz) 25(900~1002MHz) 25(1350~1675MHz) 35(2000~2500MHz) 27(2500~5900MHz)	2.0	50	3.20x2.50x1.80	K

LTE Band Application

Part Number	Frequency Range(MHz)	Insertion Loss (dB)	Attenuation (dB min.)	VSWR (max.)	Impedance (Ω)	Size(mm)	STRUCTURE
RFBPF1109B101T	2110~2170	1.7	25(4280MHz)	2	50	1.10x0.90x0.60	E
RFBPF1109B201T	1930~1990	1.7	25(3920MHz)	2	50	1.10x0.90x0.60	E
RFBPF1109B301T	1805~1880	1.4	25(3685MHz)	2	50	1.10x0.90x0.60	E
RFBPF1109B501T	869~894	0.9	12(1763MHz)	2	50	1.10x0.90x0.60	E
RFBPF1109B701T	2620~2690	1.2	25(5310MHz)	2	50	1.10x0.90x0.60	E
RFBPF1109B801T	925~960	0.9	12(1885MHz)	2	50	1.10x0.90x0.60	E
RFBPF16081G9DM1T79	1805~2025	1.6max.(25°C) 1.8max.(-40~+85°C)	25(700~950MHz) 15(950~1050MHz) 25(2400~2500MHz) 35(2700~5150MHz) 40(5150~5850MHz) 25(5850~12750MHz)	2	50	1.60x0.80x0.70	G
RFBPF16081G9DMAT73	1805~2025	2.0	30(700~950MHz) 15(950~1050MHz) 40(2400~2500MHz) 35(2700~5400MHz) 35(5500~6200MHz) 35(9350~10150MHz) 20(10500~12750MHz)	2	50	1.60x0.80x0.70	G
RFBPF16081G9DMAT79	1880~2025	2.0max.(25°C) 2.2max.(-40~+85°C)	20(1545~1610MHz) 25(2400~2500MHz) 25(5150~5850MHz)	2	50	1.60x0.80x0.70	G
RFBPF16081G9DS8T60	1805~2025	1.6	30(700~950MHz) 15(950~1050MHz) 25(2400~2500MHz) 35(2700~5400MHz) 35(5500~6200MHz) 35(9350~10150MHz) 20(10500~12750MHz)	2	50	1.60x0.80x0.70	G

■ TYPICAL ELECTRICAL CHARACTERISTICS

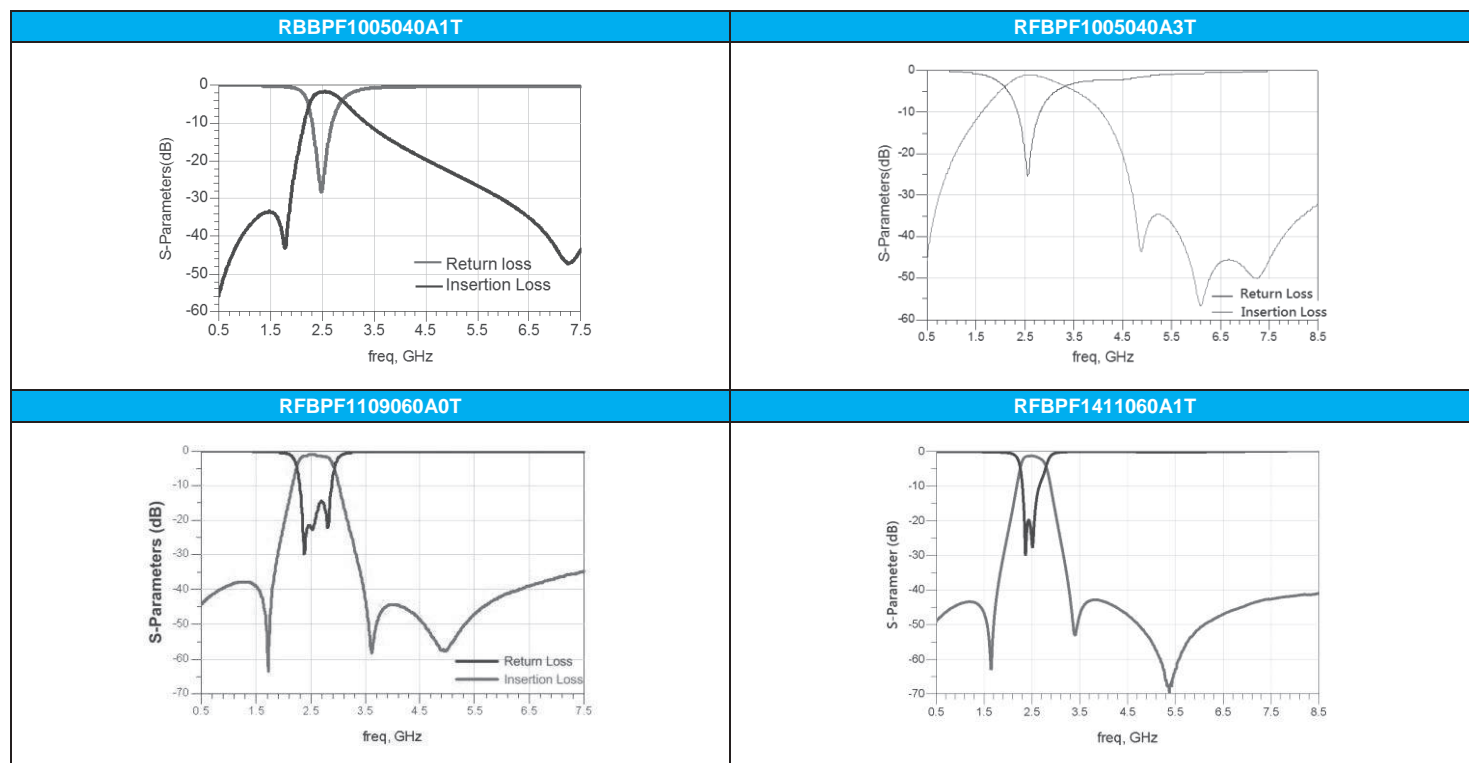

TYPICAL ELECTRICAL CHARACTERISTICS

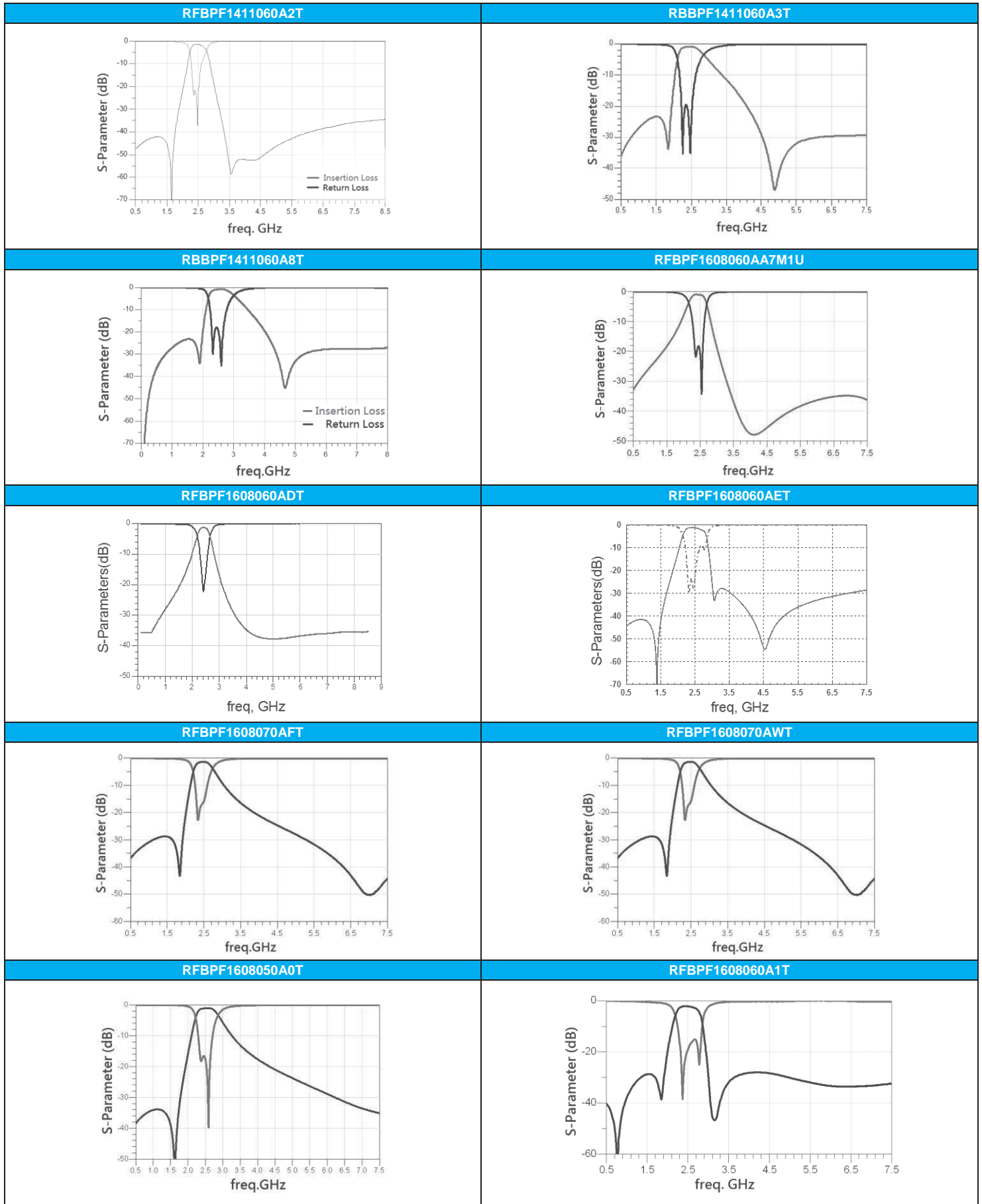

TYPICAL ELECTRICAL CHARACTERISTICS

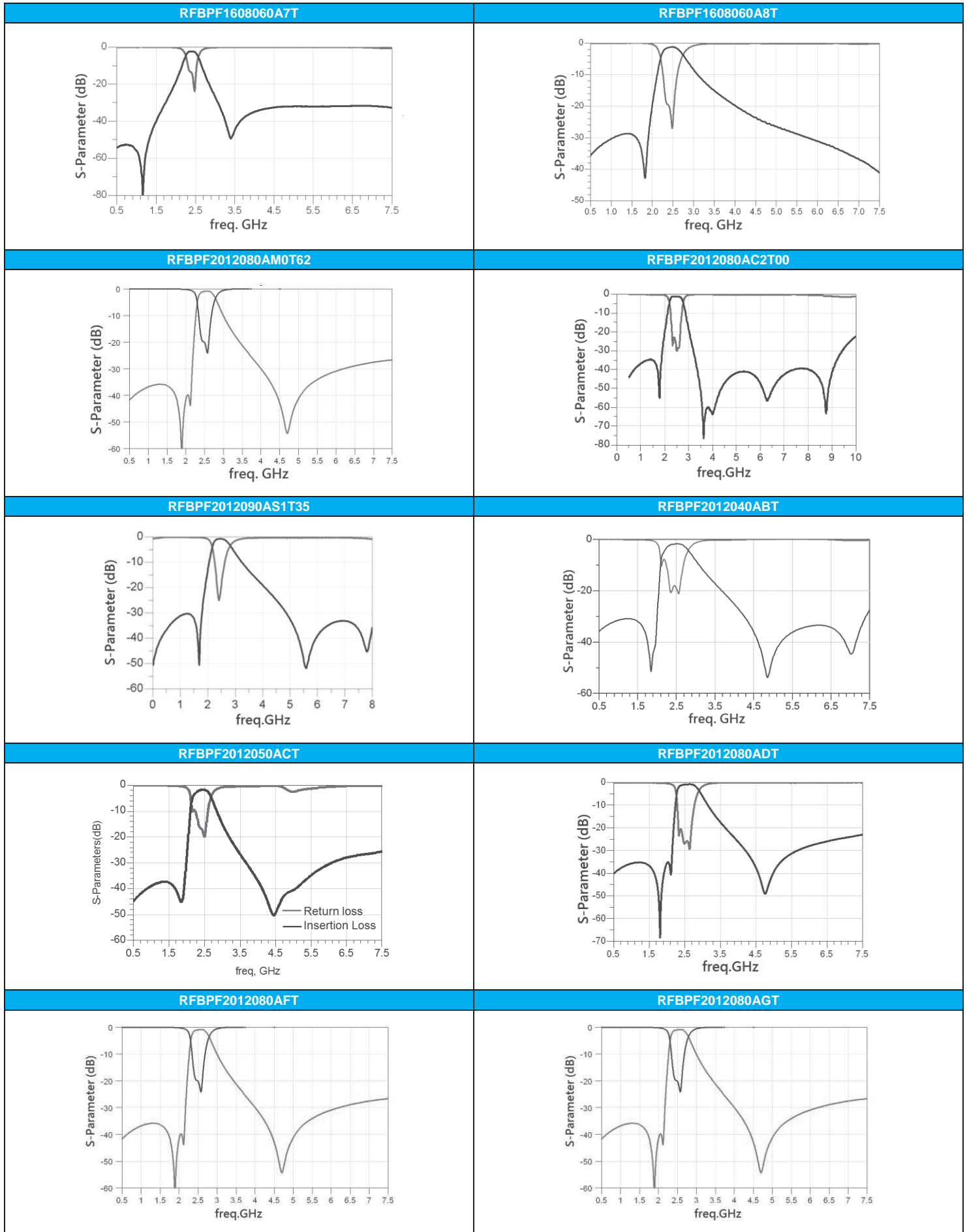

TYPICAL ELECTRICAL CHARACTERISTICS

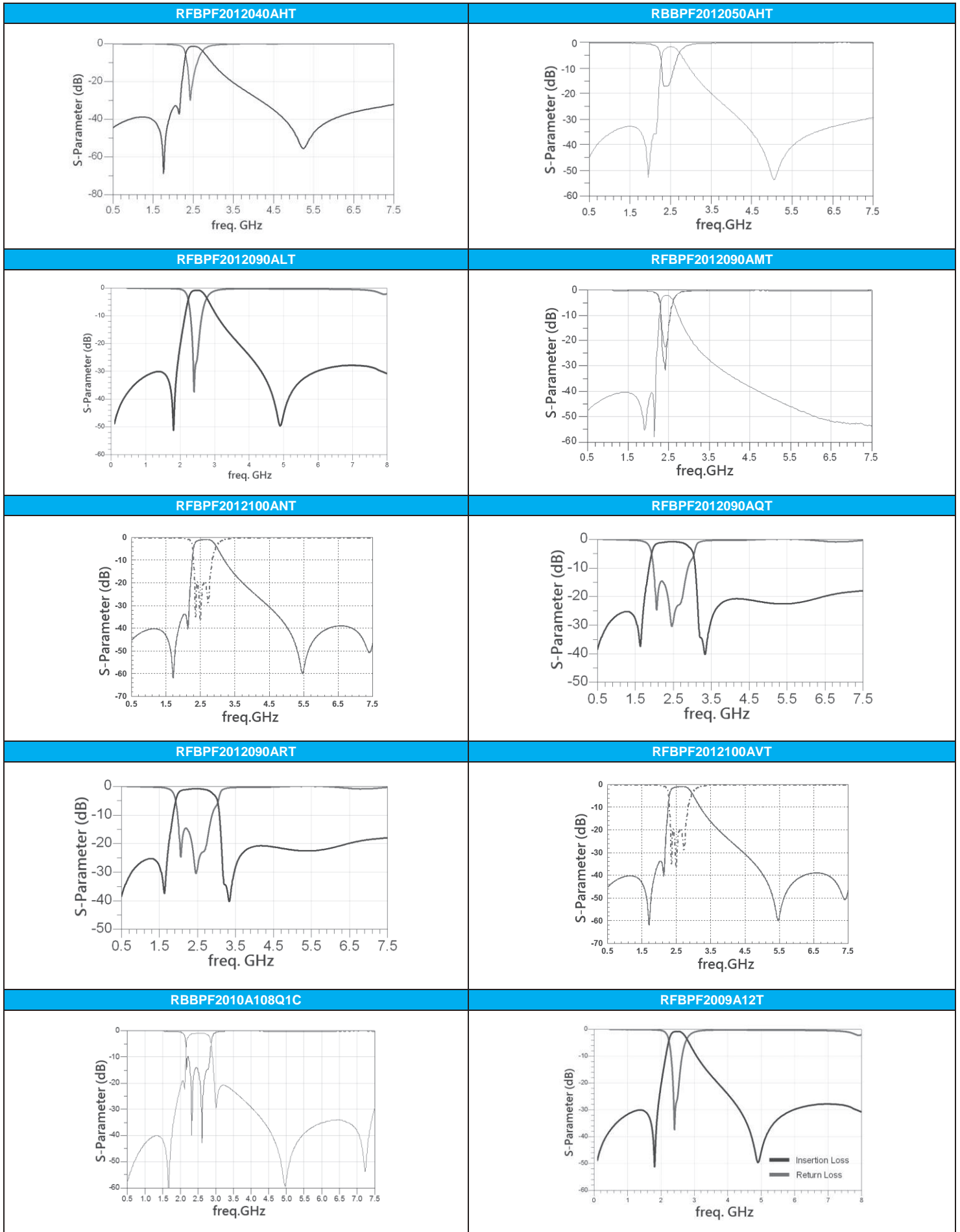

TYPICAL ELECTRICAL CHARACTERISTICS

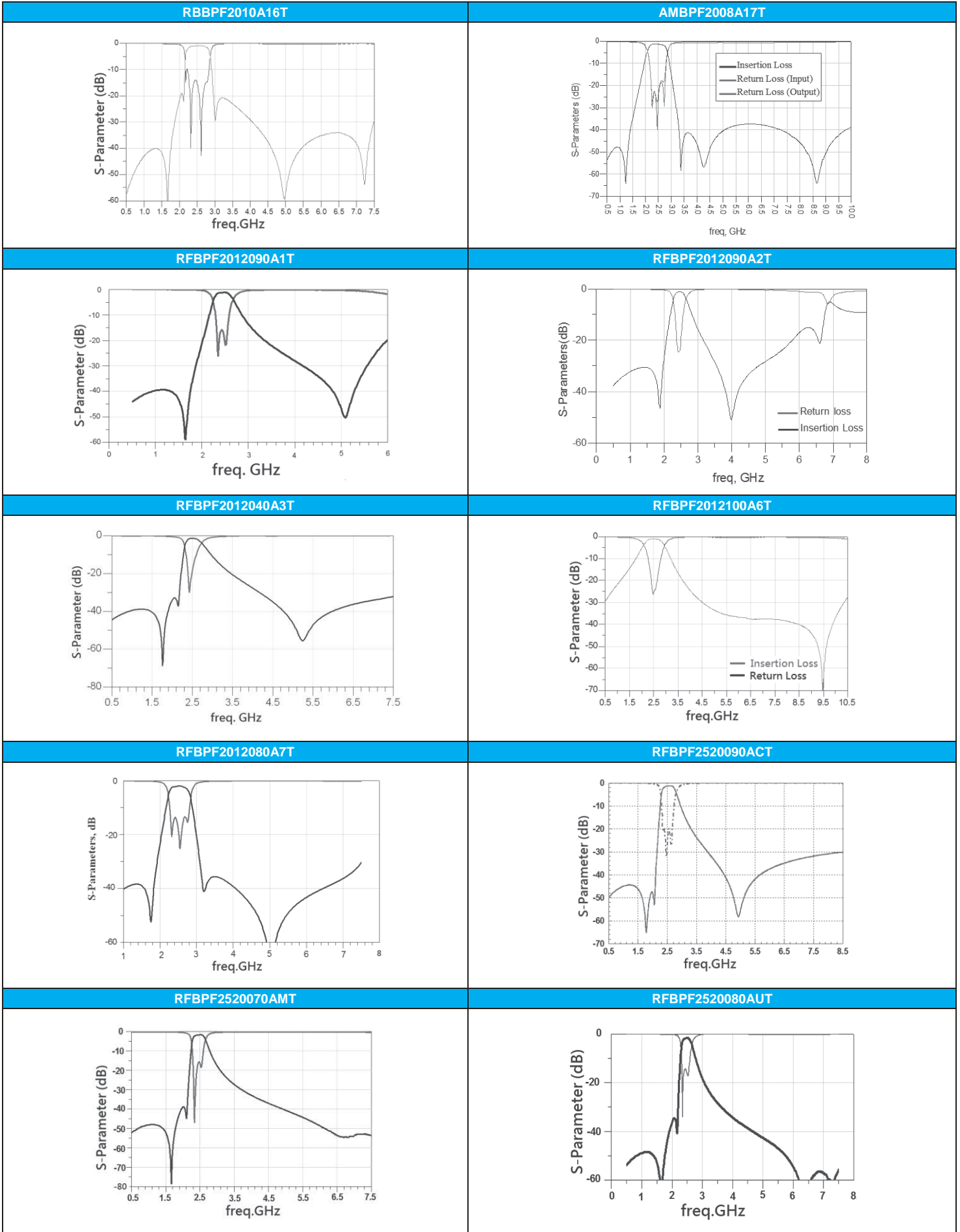

TYPICAL ELECTRICAL CHARACTERISTICS

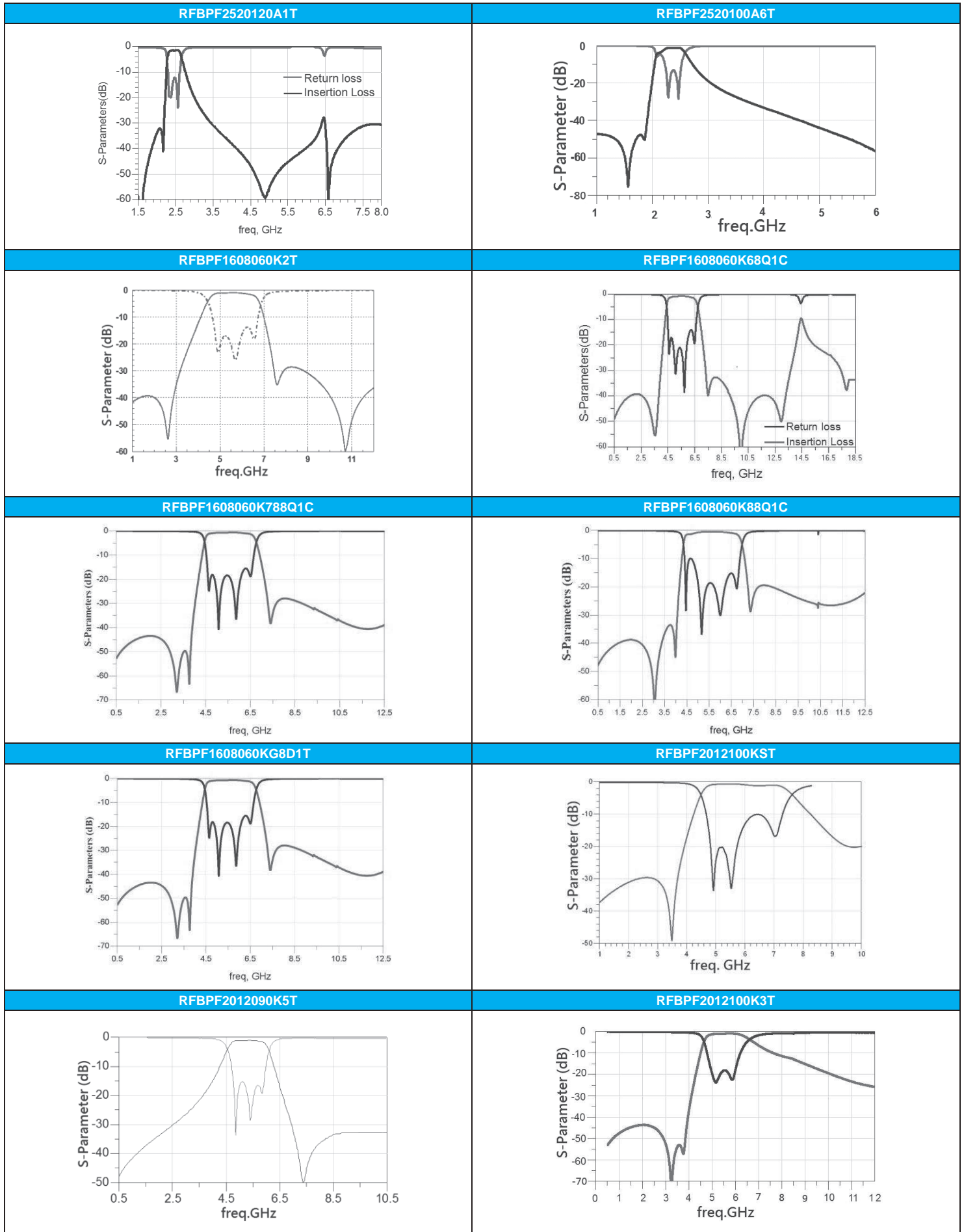

TYPICAL ELECTRICAL CHARACTERISTICS

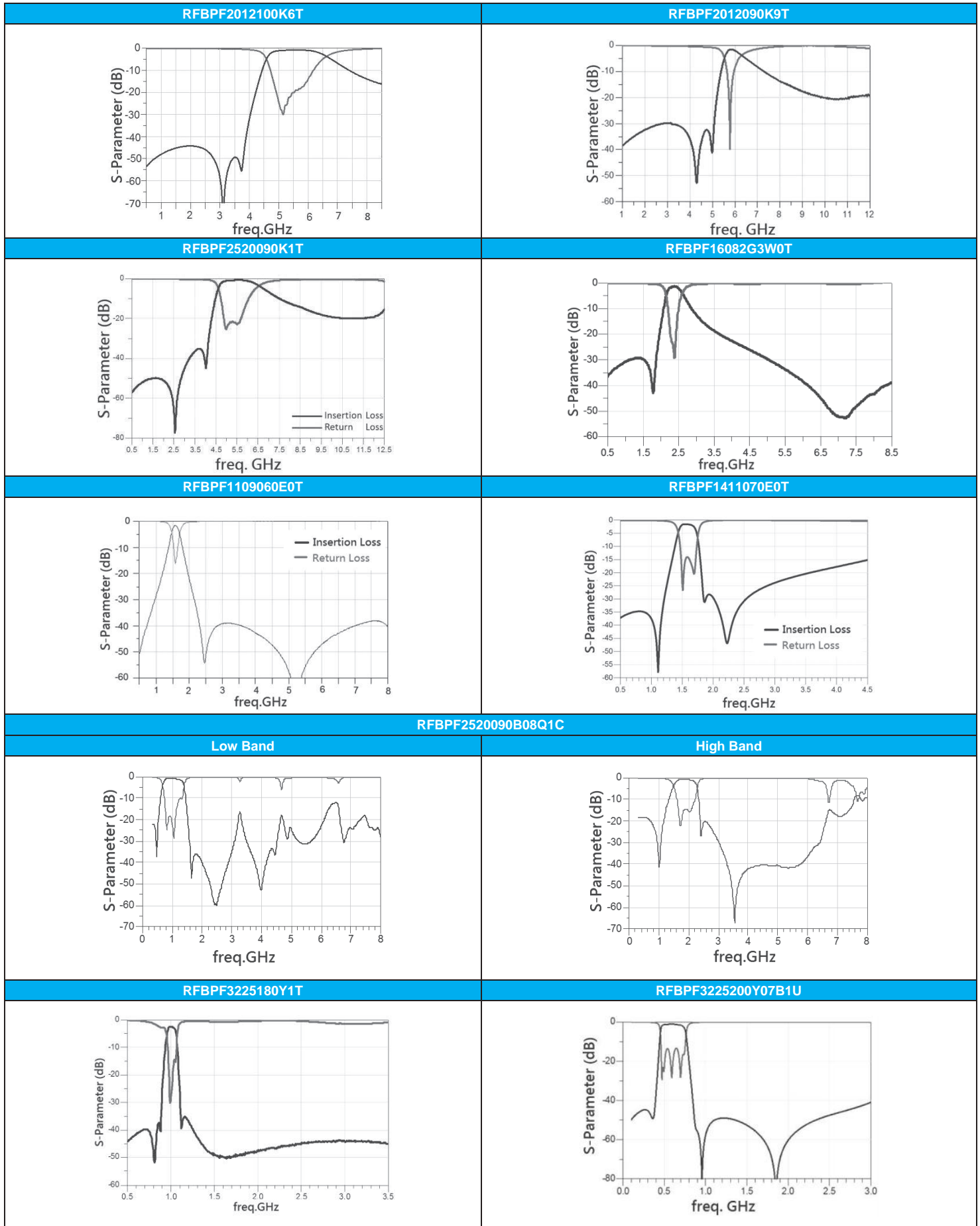

TYPICAL ELECTRICAL CHARACTERISTICS

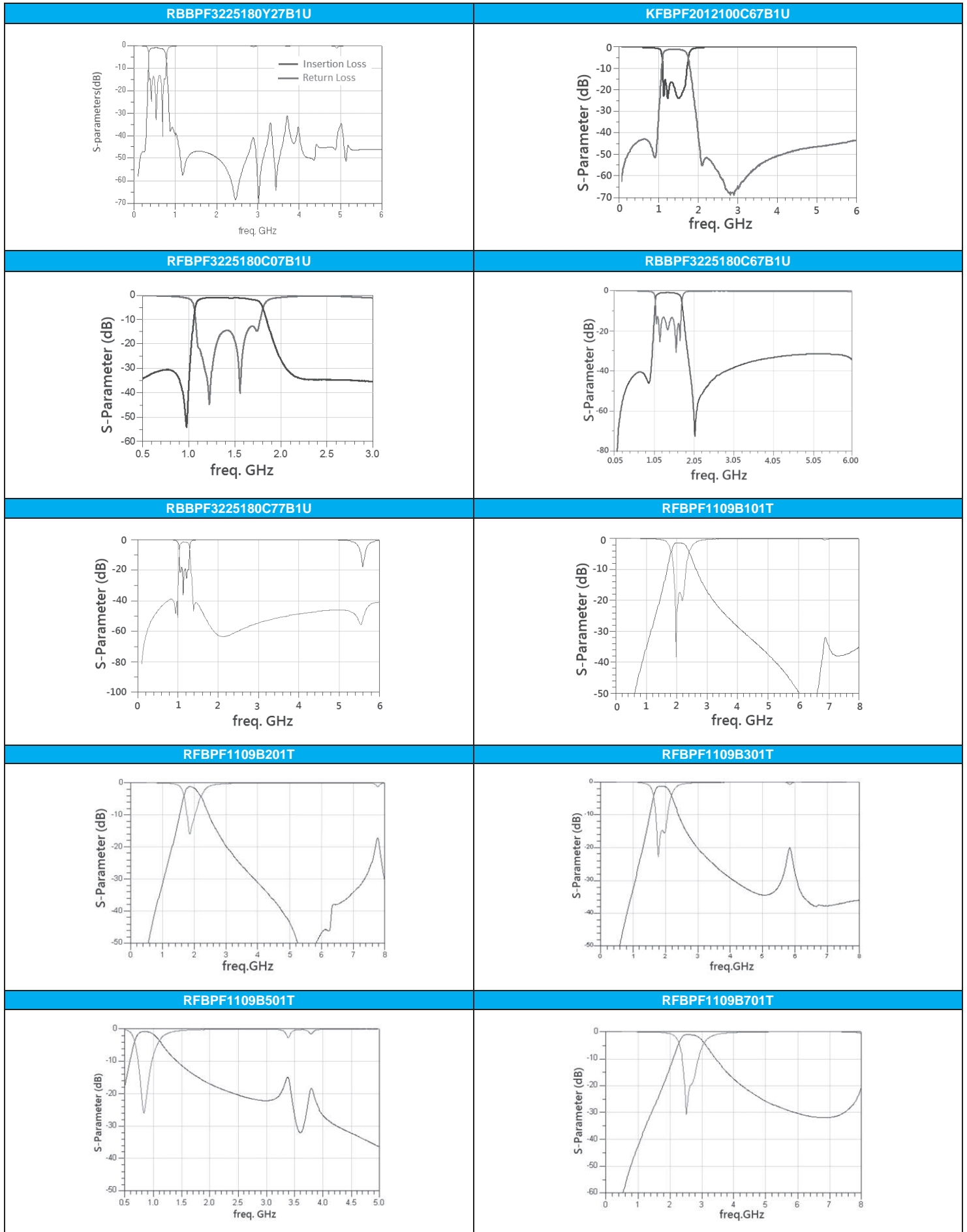

TYPICAL ELECTRICAL CHARACTERISTICS

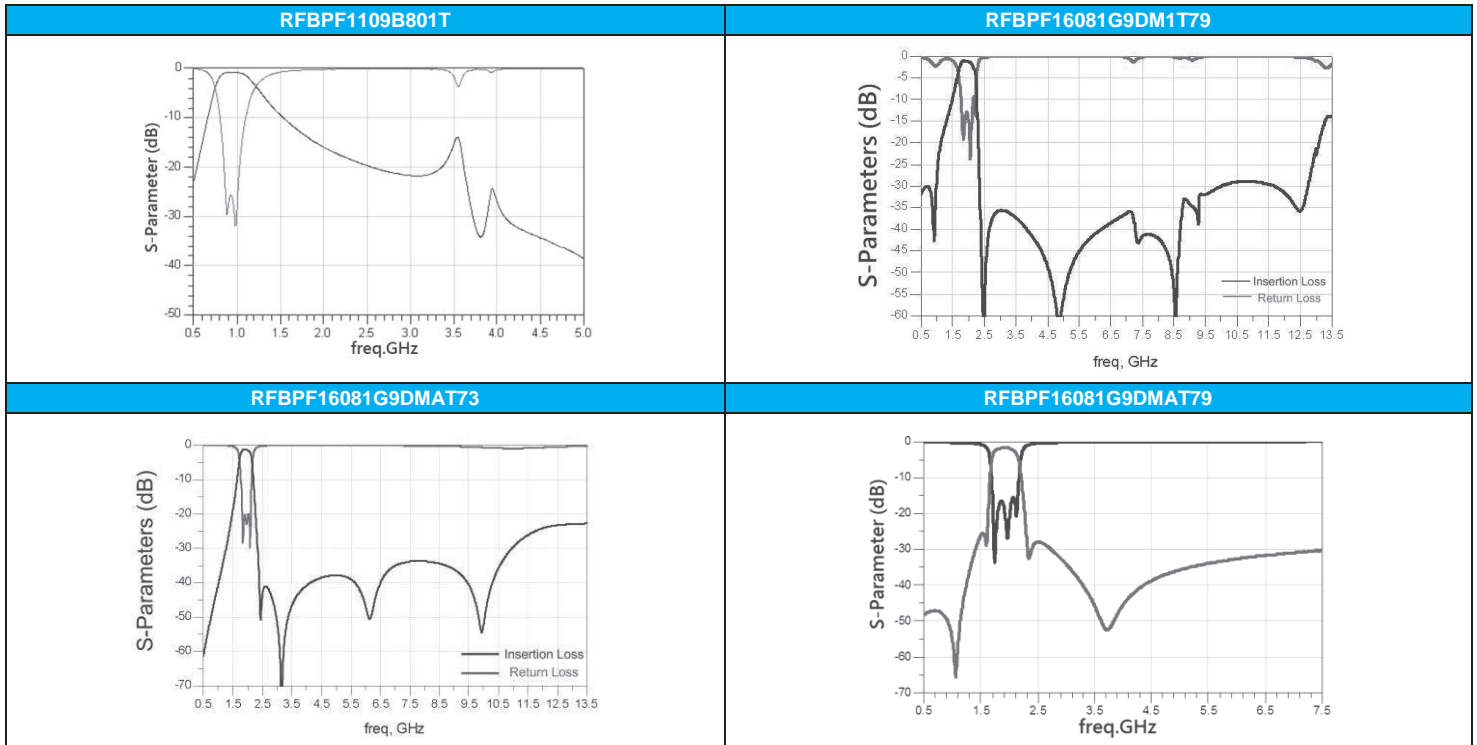

- For more information, please contact with local sales representative
- All specifications are subject to change without notice

HIGH FREQUENCY MULTILAYER BALANCED FILTER

■ **STRUCTURE AND PIN ASSOCIATED**

STRUCTURE A

STRUCTURE A-1

STRUCTURE A-2

STRUCTURE B

■ **STRUCTURE AND DIMENSION**

Unit: mm

Structure/ Dimension	L	W	T	A	B	C	D	E	F	G	
A	1.60±0.15	0.80±0.15	0.60±0.10	0.175±0.15	0.25±0.15	0.25±0.15	0.50±0.15	0.20±0.15	0.20±0.15	0.30±0.15	
	2.00±0.15	1.25±0.15	1.20±0.10	0.40±0.10	0.175±0.10	0.35±0.15	0.30±0.15	0.65±0.10	0.20±0.10	0.20±0.15	0.50±0.10
			0.50±0.10	0.20±0.15	0.30±0.15	0.35±0.15	0.65±0.15	0.20±0.15	0.20±0.15	0.30±0.15	
			0.60±0.10	0.20±0.15	0.30±0.10	0.35±0.10	0.65±0.10	0.20±0.15	0.20±0.15	0.50±0.10	
			0.90±0.10	0.20±0.15	0.30±0.10	0.35±0.10	0.65±0.10	0.20±0.15	0.20±0.15	0.30±0.10	
			1.00±0.10	0.20±0.15	0.30±0.10	0.35±0.10	0.65±0.10	0.20±0.10	0.20±0.15	0.50±0.10	
			1.10±0.10	0.20±0.15	0.30±0.10	0.35±0.10	0.65±0.10	0.20±0.15	0.20±0.15	0.55±0.10	
	2.50±0.20	2.00±0.20	0.85±0.10	0.35±0.20	0.40±0.10	0.30±0.10	0.70±0.20	0.15(Typical)	0.15(Typical)	1.20±0.20	
B	1.95±0.15	1.25±0.15	0.80±0.10	0.175±0.15	0.30±0.15	0.35±0.15	0.65±0.15	0.25±0.15	-	-	
	2.00±0.15	1.25±0.10	0.60±0.10	0.20±0.10	0.30±0.15	0.35±0.15	0.65±0.10	0.25±0.10	-	-	

■ ELECTRICAL SPECIFICATION

2.4GHz BAND WORKING FREQUENCY

Part Number	Frequency Range (MHz)	Impedance(Ω)		Insertion Loss (dB)	Attenuation (dB min.)	VSWR (Max.)	Phase Difference	Amplitude Difference	Size (mm)	STRUCTURE
		Unbalance	Balance							
RFBPB2012090A1T	2.4~2.5	50	Conjugate match to BC series of Bluetooth chipset	3.5	35(880~960MHz) 30(1710~1880MHz) 20(1880~1990MHz) 30(4800~5000MHz)	2.1	180°± 10	2	2.00x1.25x0.9 0	A-1
RFBPB2012090A9T	2.4~2.5	50	Conjugate match to BC series of Bluetooth chipset	2.8	35(880~960MHz) 30(1575MHz) 25(1710~1880MHz) 30(4800~5000MHz)	2.1	180°± 10	2	2.00x1.25x0.9 0	A-1
RFBPB2012090AAT	2.4~2.5	50	Conjugate match to CSR BC03/ 04 series	3.5	35(880~960MHz) 30(1710~1880MHz) 20(1880~1990MHz) 30(4800~5000MHz)	2.1	180°± 10	2	2.00x1.25x0.9 0	A-1
RFBPB2012060ABT	2.4~2.5	50	Impedance match to T.I. CC253X,CC254X, CC257X, CC853X and CC852X Chipsets	1.5max.(25°C) 1.7max. (-40~+85°C)	12(1000MHz) 15(4800~5000MHz) 20(7200~7500MHz)	2.0	180°± 15	2	2.00x1.25x0.6 0	B
RFBPB2012080AET	2.4~2.5	50	Impedance match to: Atmel AT86RF232, AT86RF233, ATMega256RF R2, Zigbit 256RFR2, Zigbit RF233, ZigBit RF233+FEM, Extension RF233, USB RF233	1.5max.(25°C) 1.7max. (-40~+85°C)	20(4800~5000MHz) 20(7200~7500MHz)	2.0	180°± 10	2	1.95x1.25x0.8 0	B
RFBPB2012090AHT	2.4~2.5	50	100	3.5	30(880~960MHz) 30(1710~1880MHz) 20(1880~1990MHz) 30(4800~5000MHz)	2.0	180°± 10	2	2.00x1.25x0.9 0	A-1
RFBPB2012090AM1T59	2.4~2.5	50	Conjunction to MT5931/MT6628 Chipset	2.5 (typ.2.2)	35(824~960 MHz) 32(1990 MHz) 18(2170 MHz) 40(4800~5000MHz) 25(7200~7500MHz)	2.0	180°± 10	2	2.00x1.25x0.9 5	A-1
RFBPB2012090AM1T61	2.4~2.5	50	Conjugate match to MTK MT6611 Bluetooth chipset	2.8	35(880~960MHz) 30(1710~1880MHz) 20(1880~1900MHz) 30(4800~5000MHz)	2.1	180°± 10	2	2.00x1.25x0.9 0	A-1
RFBPB2012100A6T	2.4~2.5	50	Conjugate match to BC series of Bluetooth chipset	3.5	35(880~960MHz) 30(1710~1880MHz) 20(1880~1900MHz) 40(4800~5000MHz)	2.0	180°± 10	2	2.00x1.25x1.0 0	A-1
RFBPB2012110A5T	2.4~2.5	50	50	2.8	30(880~960 MHz) 30(1710~1880 MHz) 20(1880~1990 MHz) 30(4800~5000 MHz)	2.0	180°± 10	2	2.00x1.25x1.1 0	A-1
RFBPB2520090A7T	2.4~2.5	50	Conjugate match to TI BRF6150	3.5	35(880~960MHz) 30(1710~1880MHz) 25(1880~1990MHz) 25(4800~5000MHz)	2.0	180°± 15	1.5	2.50x2.00x0.9 0	A-2

■ TYPICAL ELECTRICAL CHARACTERISTICS

RFBPB2012090A1T

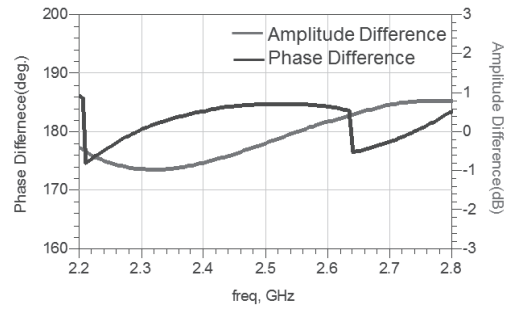
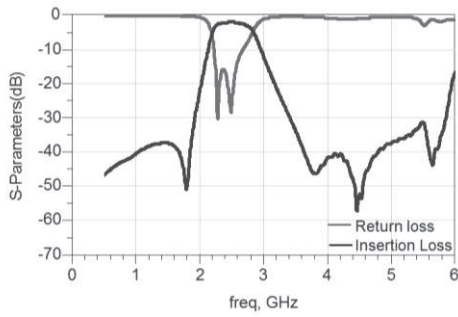

RFBPB2012090A9T

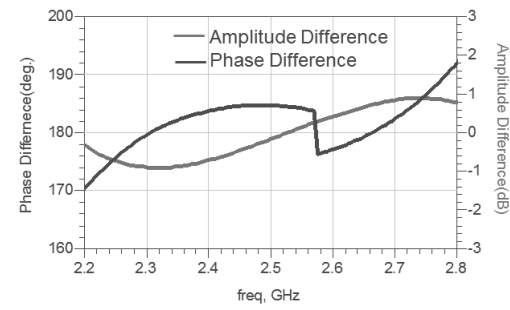
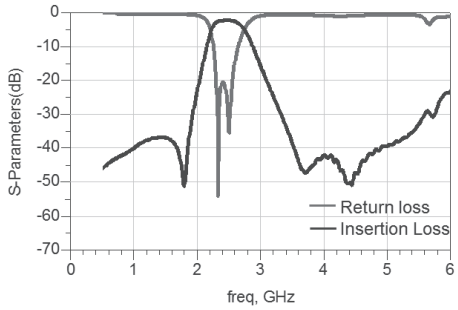

RFBPB2012060ABT

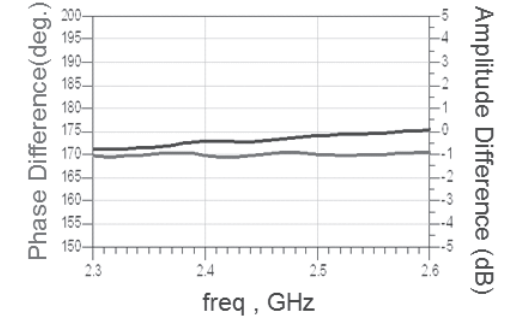
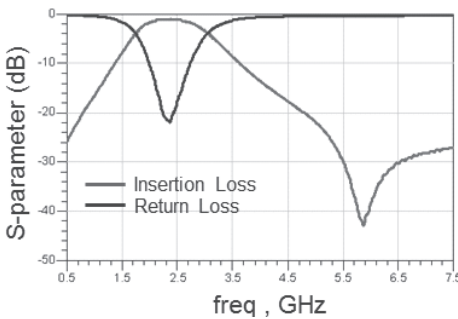

RFBPB2012080AET

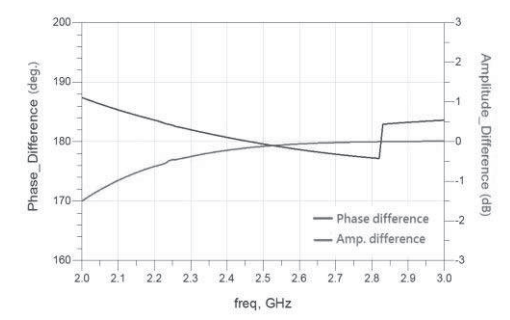
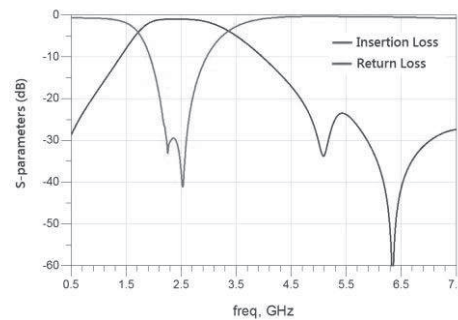

RFBPB2012090AHT

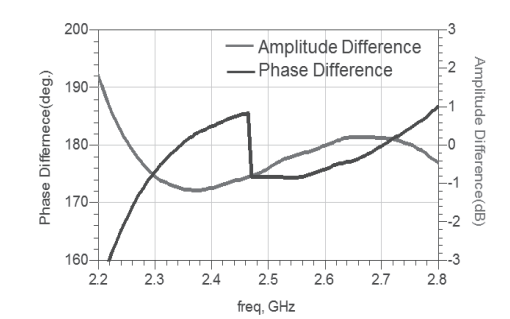
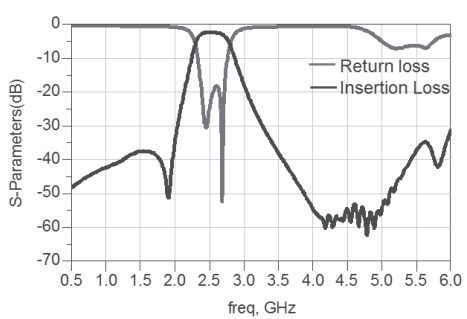

TYPICAL ELECTRICAL CHARACTERISTICS

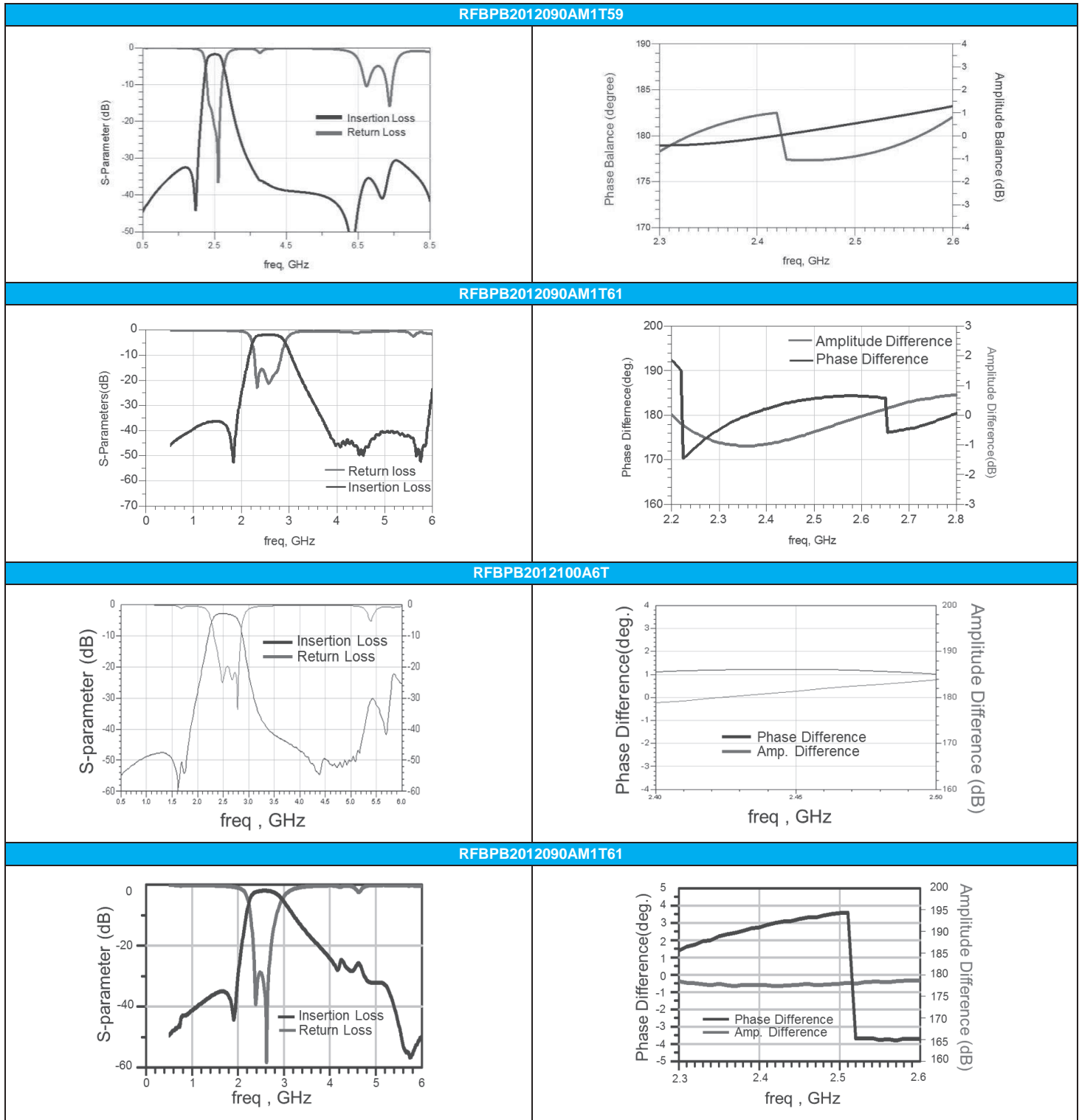

- For more information, please contact with local sales representative
- All specifications are subject to change without notice

HIGH FREQUENCY MULTILAYER LOW PASS FILTER

■ **STRUCTURE AND PIN ASSOCIATED**

STRUCTURE A					
	<p>STRUCTURE A-1</p>		<p>STRUCTURE A-2</p>		
	<p>STRUCTURE A-3</p>		<p>STRUCTURE A-4</p>		
STRUCTURE B					
	<p>STRUCTURE B-1</p>		<p>STRUCTURE B-2</p>		
STRUCTURE C	STRUCTURE D	STRUCTURE E	STRUCTURE F	STRUCTURE G	STRUCTURE H

■ **STRUCTURE AND DIMENSION**

Unit: mm

Structure	Dimension	L	W	T	A	B	C	D	E	F
A	1.60±0.15	0.80±0.15	0.50max.	0.20±0.10	0.24±0.10	0.24±0.10	0.50±0.10	0.15±0.10	-	
			0.60±0.10	0.175±0.15	0.25±0.15	0.25±0.15	0.50±0.15	0.20±0.15	-	
			0.65±0.10	0.175±0.15	0.25±0.15	0.25±0.15	0.50±0.15	0.20±0.15	-	
			0.70max.	0.175±0.15	0.25±0.15	0.25±0.15	0.50±0.15	0.20±0.15	-	
B	2.00±0.15	1.25±0.10	0.90±0.10	0.20±0.10	0.30±0.10	0.35±0.10	0.65±0.10	0.20±0.10	0.20±0.10	
			0.95±0.10	0.20±0.10	0.30±0.10	0.35±0.10	0.65±0.10	0.20±0.10	0.20±0.10	
			1.05±0.10	0.20±0.10	0.30±0.10	0.35±0.10	0.65±0.10	0.20±0.10	0.20±0.10	
C	3.20±0.20	2.50±0.20	1.00±0.20	0.10min.	0.55±0.15	0.45±0.15	1.00±0.15	0.30±0.15	0.70±0.20	
			1.00±0.10	0.50±0.10	0.40±0.10	0.35±0.10	0.30±0.10	0.15±0.10	0.15±0.10	-
D	1.60±0.15	0.80±0.15	0.50max.	0.45±0.15	0.70±0.15	0.20±0.15	0.20±0.15	0.30±0.15	0.25±0.15	
			0.65±0.10	0.50±0.10	0.40max.	0.20±0.05	0.20±0.05	0.025±0.025	0.10±0.05	0.25±0.05
E	1.60±0.15	0.80±0.15	0.45max.	0.23±0.05	0.40±0.10	0.30±0.10	0.65±0.10	0.20±0.05	0.23±0.05	
			0.65max.	0.23±0.05	0.40±0.10	0.30±0.10	0.65±0.10	0.20±0.05	0.23±0.05	
			0.60±0.10	0.23±0.05	0.40±0.10	0.30±0.10	0.65±0.10	0.20±0.05	0.23±0.05	
F	1.60±0.10	0.80±0.10	0.65max.	0.60±0.10	0.25±0.10	0.25±0.10	0.40±0.10	0.10±0.05	0.10±0.05	
			2.00±0.15	1.25±0.10	0.90±0.10	0.95±0.10	0.275±0.10	0.25±0.10	0.60±0.10	0.175±0.10
G	1.00±0.10	0.50±0.10	1.00max.	0.95±0.10	0.275±0.10	0.25±0.10	0.60±0.10	0.175±0.10	0.15±0.10	
			1.00±0.10	0.50±0.10	0.40 max.	0.18±0.05	0.18±0.05	0.05±0.05	0.125±0.05	0.15±0.05
H	3.20±0.20	2.50±0.20	1.00±0.20	0.95±0.20	0.60±0.20	0.30±0.15	0.70±0.15	1.20±0.15	2.00±0.15	
			1.80±0.20	0.95±0.20	0.60±0.20	0.30±0.15	0.70±0.15	1.20±0.15	2.00±0.15	

■ **ELECTRICAL SPECIFICATION**

GSM850/900GHz BAND WORKING FREQUENCY

Part Number	Frequency Range (MHz)	Insertion Loss (dB)	Attenuation (dB min.)	VSWR (max.)	Impedance (Ω)	Size(mm)	Structure
RFLPF06050G9D0T	824~915	0.5max.(25°C) 0.7max.(-40~+85°C)	20(2400~2750MHz)	2.0	50	0.65x0.50x0.40	D
RFLPF10050G9D0T	824~915	0.6	25(1648~1830MHz) 25(2472~2745MHz) 25(3296~3660MHz)	2.0	50	1.00x0.50x0.40	C
RFLPF10050G9D3T	824~915	0.5max.(25°C) 0.7max.(-40~+85°C)	25(1648~1830MHz) 25(2472~2745MHz) 25(3296~3660MHz)	2.0	50	1.00x0.50x0.40	C
RFLPF10050G9D4T	699~915	0.5max.(25°C) 0.7max.(-40~+85°C)	25(1648~1830MHz) 25(2472~2745MHz) 25(3296~3660MHz)	2.0	50	1.00x0.50x0.40	C
RFLPF10050G9D58Q1C	814~915	0.5max.(25°C) 0.65max.(-40~+85°C)	18(1648~1830MHz) 17(2472~2745MHz)	2.0	50	1.00x0.50x0.40	C
RFLPF16080G9D4T	698~960	0.60(698~830MHz) 0.70(830~900MHz) 0.75(900~915MHz) 0.90(915~960MHz)	30(1554~1830MHz) 35(2097~2745MHz)	1.6	50	1.60x0.80x0.65	A-3
RFLPF16080G9DM1T58	698~960	0.8	16(1565~1610MHz) 32(2110~2155MHz)	2.0	50	1.60x0.80x0.50	A-4
RFLPF10050G9DM1T76	698~960	0.6max.(25°C) 0.65max.(-40~+85°C)	13(1554~1610MHz) 35(1805~1830MHz) 35(2110~2170MHz) 30(1710~2700MHz)	2.0	50	1.00x0.50x0.40	G
RFLPF20120G9D0T	890~915	0.6max.(25°C) 0.75max.(-40~+85°C)	30(1780~1830MHz) 30(2670~2745MHz)	2.0	50	2.00x1.25x0.95	B-2
RFLPF20120G9D1T	890~915	0.6max.(25°C) 0.75max.(-40~+85°C)	40(1720~1765MHz) 30(1780~1830MHz) 30(2670~2745MHz)	2.0	50	2.00x1.25x0.95	B-2

DCS/PCS BAND WORKING FREQUENCY

Part Number	Frequency Range (MHz)	Insertion Loss (dB)	Attenuation (dB min.)	VSWR (max.)	Impedance (Ω)	Size(mm)	Structure
RFLPF10051G8D0T	1710~1910	0.8	35(3420~3570MHz) 35(3700~3820MHz) 35(5130~5730MHz)	2.0	50	1.00x0.50x0.40	C
RFLPF10051G8DM5T51	1710~1910	0.6	26(3420~3570MHz) 21(3700~3820MHz) 21(5130~5730MHz)	2.0	50	1.00x0.50x0.40	C
RFLPF10051G8DM1T76	1880~2025	1.4max.(25°C) 1.6max.(-40~+85°C)	20(2400~2500MHz) 25(3760~4050MHz) 25(5150~5850MHz) 25(5640~6075MHz)	2.0 (typ.1.16)	50	1.00x0.50x0.40	G
RFLPF16081G8D3T	1710~1910	0.45max.(25°C) 0.55max.(-40~+85°C)	30(3420~3570MHz) 25(3700~3820MHz) 25(5130~5730MHz)	2.0	50	1.60x0.80x0.50	C
RFLPF16081G8D78Q1C	1880~2025	1.4	25(2400~2500MHz) 18(4020~4045MHz) 25(6030~6075MHz)	2.0	50	1.60x0.80x0.60	F
RFLPF16081G8DC8Q1C	1880~2170	0.60(1880~1920MHz) 0.70(1920~1980MHz) 0.80(2010~2170MHz) 2.00(2025~2170MHz)	15(2400~2500MHz) 20(3760~4050MHz) 12(5150~5850MHz) 12(5640~6075MHz) 5(7520~8100MHz)	2.0	20	1.60x0.80x0.60	E
RFLPF20121G8D1T	1880~2025	1.35max.(25°C) 1.50max.(-40~+85°C)	38(2400~2500MHz) 25(4020~4045MHz) 27(6030~6075MHz)	1.9	50	2.00x1.20x0.90	F

2.4GHz BAND WORKING FREQUENCY

Part Number	Frequency Range (MHz)	Insertion Loss (dB)	Attenuation (dB min.)	VSWR (max.)	Impedance (Ω)	Size(mm)	Structure
RFLPF1005040A0T	2450±50	0.45max.(25°C) 0.55max.(-40~+85°C)	21(4800~5000MHz) 21(7200~7500MHz)	1.7	50	1.00x0.50x0.40	C
RFLPF1005040A1T	2450±50	0.75	33(4800~5000MHz) 37(7200~7500MHz)	2.0	50	1.00x0.50x0.40	C
RFLPF1005040A2T	2450±50	0.75max.(25°C) 0.90max.(-40~+85°C)	32(4800~5000MHz) 35(7200~7500MHz)	2.0	50	1.00x0.50x0.40	C
RFLPF1608060AM2T66	2450±50	0.65 (typ.0.55)	20(3603~3720MHz) 30(4804~4960MHz) 10(6005~6200MHz) 20(7206~7440MHz) 10(8407~8680MHz) 20(9608~9920MHz) 10(10809~11160MHz) 10(12010~12400MHz) 10(13211~13640MHz) 15(14412~14880MHz) 10(15613~16120MHz) 10(16814~17360MHz)	2.0 (typ.1.5)	50	1.60x0.80x0.65	A-1
RFLPF1608060AAT	2450±50	0.65	20(3603~3720MHz) 30(4804~4960MHz) 10(6005~6200MHz) 20(7206~7440MHz) 10(8407~8680MHz) 20(9608~9920MHz) 10(10809~11160MHz) 10(12010~12400MHz) 10(13211~13640MHz) 15(14412~14880MHz) 10(15613~16120MHz) 10(16814~17360MHz)	2.0	50	1.60x0.80x0.70	A-1
RFLPF1608060ABT	2450±50	0.50	35(4800~5000MHz) 25(7200~7500MHz)	2.0	50	1.60x0.80x0.60	A-1
RFLPF1608060A0T	2450±50	0.65 (typ.0.48)	35(4800MHz(typ.40)) 27(7200MHz(typ.40))	1.5	50	1.60x0.80x0.60	A-1
RFLPF1608060A1T	2450±50	0.6	27(4800~5000MHz) 30(7200~7500MHz)	2.0	50	1.60x0.80x0.60	A-2
RFLPF1608060A2T	2450±50	0.42	25(4800MHz) 18(7200MHz)	1.5	50	1.60x0.80x0.60	A-1
RFLPF1608060A9T	2450±50	0.50max.(25°C) 0.60max.(-40~+85°C)	20(3400MHz) 20(3600MHz) 30(4800~5000MHz) 30(7200~7500MHz)	2.0	50	1.60x0.80x0.60	E
RFLPF2012110A0T	2450±50	0.7	30(2x(f _o ±BW/2)) 20(3x(f _o ±BW/2))	1.5	50	2.00x1.25x1.05	B-1

5GHz BAND WORKING FREQUENCY

Part Number	Frequency Range (MHz)	Insertion Loss (dB)	Attenuation (dB min.)	VSWR (max.)	Impedance (Ω)	Size(mm)	Structure
RFLPF1608050K0T	5400±500	0.60(25°C) 0.70(-40~+85°C)	25(9800MHz) 30(11900MHz) 20(17850MHz) (for reference)	2.0	50	1.60x0.85x0.50	C
RFLPF2012090K0T	5400±500	0.55(25°C) 0.65(-40~+85°C)	30(9800MHz) 30(11800MHz) 20(17550MHz) (for reference)	2.0	50	2.00x1.25x0.90	B-1

LTE BAND APPLICATION

Part Number	Frequency Range (MHz)	Insertion Loss (dB)	Attenuation (dB min.)	VSWR (max.)	Impedance (Ω)	Size(mm)	Structure
RFLPF1005040Y0T	617~798	0.60(25°C) 0.65(-40~+85°C)	25(1565~1607MHz) 30(1920~1980MHz)	2.0	50	1.00x0.50x0.40	G
RFLPF1005040YM1T76	746~878	0.60(25°C) 0.65(-40~+85°C)	30(1554~1610MHz) 25(2238~2361MHz)	2.0	50	1.00x0.50x0.40	G
RFLPF1608060Y08Q1C	470~787	0.65(25°C) 0.71(-40~+85°C)	26(1429~1501MHz) 30(1565~1607MHz) 35(1570~1580MHz) 18(1920~1980MHz)	2.0	50	1.60x0.85x0.65	A-3
RFLPF1608060Y18Q1C	698~960	0.60(698~830MHz) 0.70(830~900MHz) 0.75(900~915MHz) 0.90(915~960MHz)	30(1554~1830MHz) 35(2097~2745MHz)	1.6	50	1.60x0.85x0.65	A-3
RFLPF2012090Y2T	400~470	0.50(25°C) 0.65(-40~+85°C)	33(800~940MHz)	2.0	50	2.00x1.25x0.90	F
RFLPF2012090Y3T	500~700	0.65(25°C) 0.80(-40~+85°C)	33(1000~1400MHz)	2.0	50	2.00x1.25x0.90	F
RFLPF2012100Y0T	DC~500	0.70	9(824~960MHz) 25(1710~1990MHz) 25(2400~4000MHz)	2.0	50	2.00x1.25x0.95	B-2
RFLPF1608060E0T	1400~2690	0.25(25°C) 0.30(-40~+85°C)	25(4905~5845MHz)	1.92	50	1.60x0.85x0.65	F
RFLPF1608060F0T	600~2700	0.50	30(4800~8000MHz) 25(8500~12500MHz)	2.0	50	1.60x0.85x0.65	F

LTE BAND APPLICATION

Part Number	Frequency Range (MHz)	Insertion Loss (dB)	Attenuation (dB min.)	VSWR (max.)	Impedance (Ω)	Size(mm)	Structure
RFLPF1608060F18Q1C	673~2690	0.50	35(4950~6000MHz) 35(6000~7500MHz) 35(7500~8100MHz) 35(8100~10500MHz) 27(10500~12500MHz)	2.0	50	1.60x0.85x0.65	F
RFLPF1608060F88Q1C	10~2700	0.5	30(4900~5950MHz)	2.0	50	1.60x0.85x0.65	E
RFLPF2012100F18Q1C	1710~2170	1.30(25°C) 1.50(-40~+85°C)	15(2400~2500MHz) 25(3250~3350MHz) 25(3420~3570MHz) 23(3700~3820MHz) 23(3840~3960MHz) 23(4100~4600MHz) 25(4905~5845MHz) 23(5850~6400MHz) 20(6600~7350MHz)	1.56	50	2.00x1.25x1.00	B-2
RFLPF2012100F28Q1C	DC~2170	0.75(25°C) 0.85(-40~+85°C)	10(2400~2500MHz) 23(3250~3350MHz) 20(3420~3570MHz) 18(3700~3820MHz) 18(3840~3960MHz) 18(4100~4600MHz) 20(4905~5845MHz) 18(5850~6400MHz) 5(6600~7350MHz)	2.0	50	2.00x1.25x1.00	F
RFLPF10052G5WM1T76	2300~2700	0.5(25°C) 0.6(-40~+85°C)	25(4600~5400MHz) 25(6900~8100MHz)	2.0	50	1.00x0.50x0.40	G
RFLPF16082G6W0T	2400~2690	0.6	26(4800~5390MHz) 23(7200~8085MHz)	2.0	50	1.60x0.80x0.60	A-2
RFLPF16082G6W2T	2300~2700	0.40(25°C) 0.43(-40~+85°C)	21(4600~5400MHz) 22(6900~8100MHz)	2.0	50	1.60x0.80x0.60	A-2
RFLPF16082G5W0T	2300~2700	0.90(25°C) 1.00(-40~+85°C)	30(4600~5400MHz) 30(6900~8100MHz) 20(9200~10800MHz) 15(11500~13500MHz)	1.8	50	1.60x0.80x0.60	A-1
RFLPF16082G5W6T	2300~2700	0.55	40(4600~5400MHz) 25(6900~8100MHz)	1.7	50	1.60x0.80x0.60	A-1
RFLPF16082G5WM0T29	2300~2690	0.80 (typ.0.40)	25(4600~5400MHz) 25(6900~8070MHz)	2.0	50	1.60x0.80x0.60	A-1
RFLPF16083G5W7T	3300~3800	0.55	17(6600~7600MHz) 20(9900~11400MHz)	1.9	50	1.60x0.80x0.60	A-3
RFLPF2012090BM0T29	800~1000 1700~1910 2010~2025	0.5(800~1000MHz) 0.8(1700~1910MHz) 1.5(2010~2025MHz)	20(2300~3700MHz) 30(3700~4100MHz) 20(4100~6100MHz) 10(6100~8000MHz)	2.0	50	2.00x1.25x0.90	F

MoCA APPLICATION

Part Number	Frequency Range (MHz)	Insertion Loss (dB)	Attenuation (dB min.)	VSWR (max.)	Impedance (Ω)	Size(mm)	Structure
RFLPF3225180Y1T	54~870	2.5	35(975~1675MHz)	2.0	75	3.20x2.50x1.80	H
RFLPF3225100Q07B1U	5~1002	2.4(25°C) 2.6(-40~+85°C)	36(1125~1675MHz)	2.0	75	3.20x2.50x1.00	H
RFLPF3225100Q2T	5~1002	2.4(25°C) 2.6(-40~+85°C)	28(1125~1675MHz)	1.9	75	3.20x2.50x1.00	B-1
RFLPF3225200Q5T	5~1002	1.8(25°C) 2.05(-40~+85°C)	33(1125~1400MHz) 26(1400~1675MHz)	2.0	75	3.20x2.50x1.80	H

TYPICAL ELECTRICAL CHARACTERISTICS

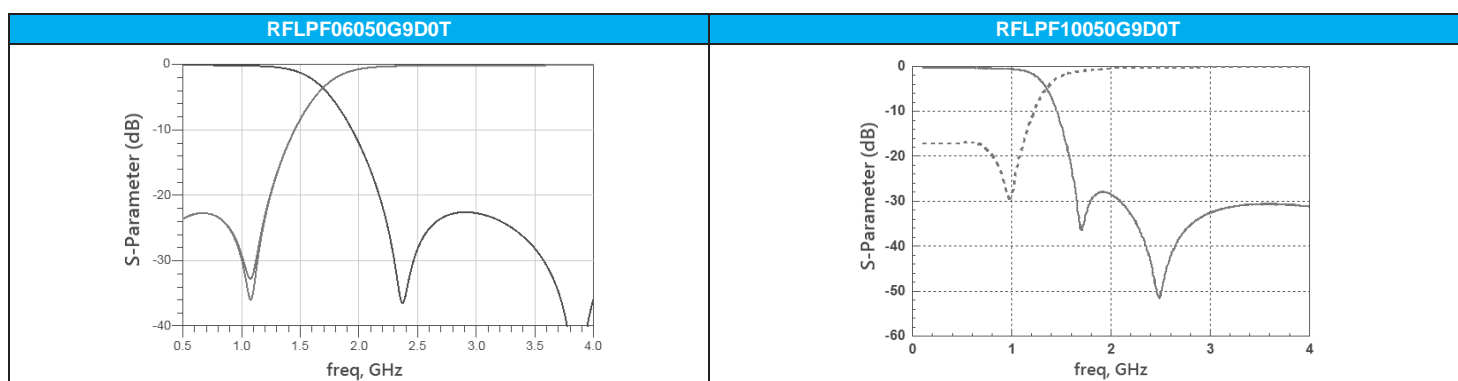

TYPICAL ELECTRICAL CHARACTERISTICS

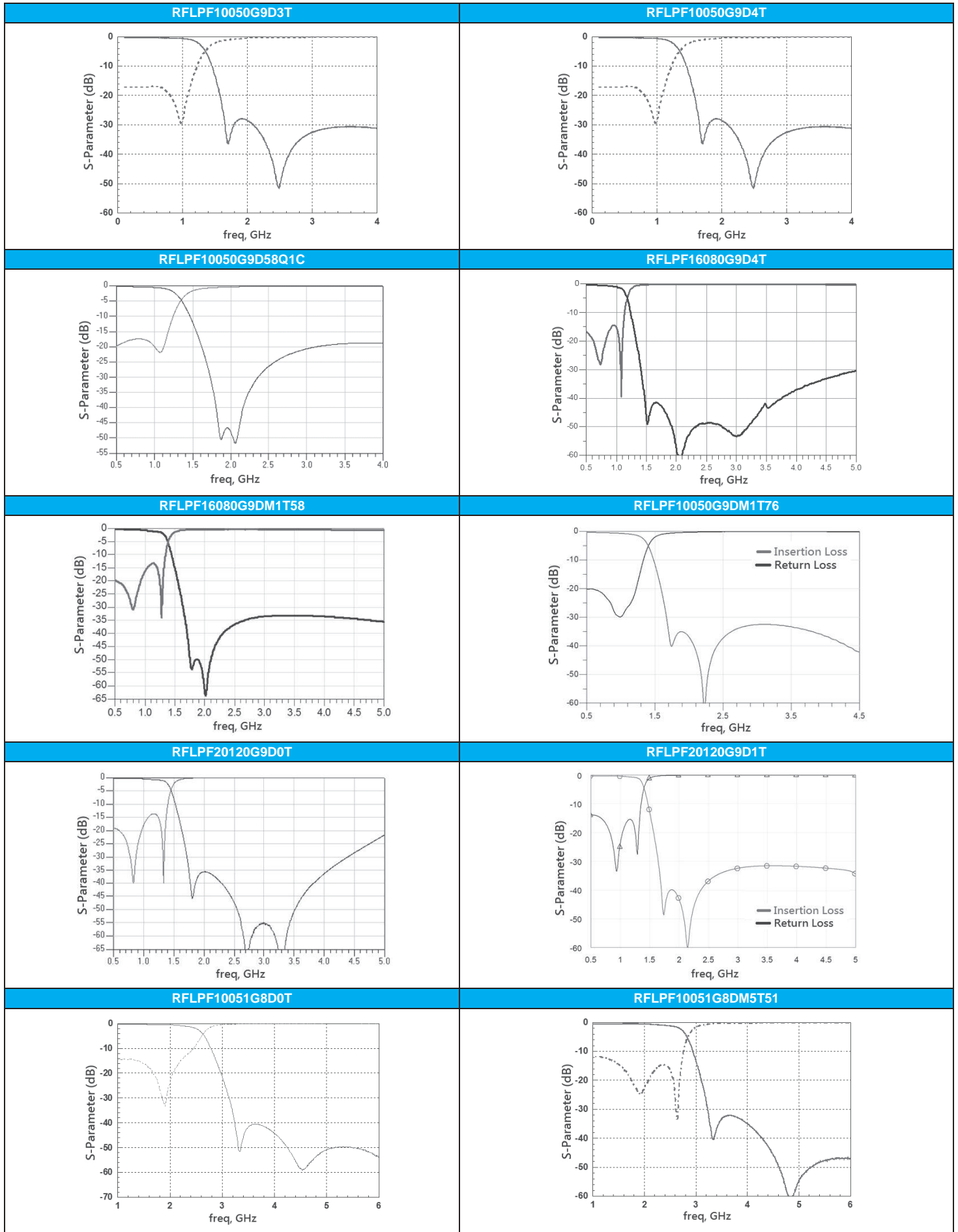

TYPICAL ELECTRICAL CHARACTERISTICS

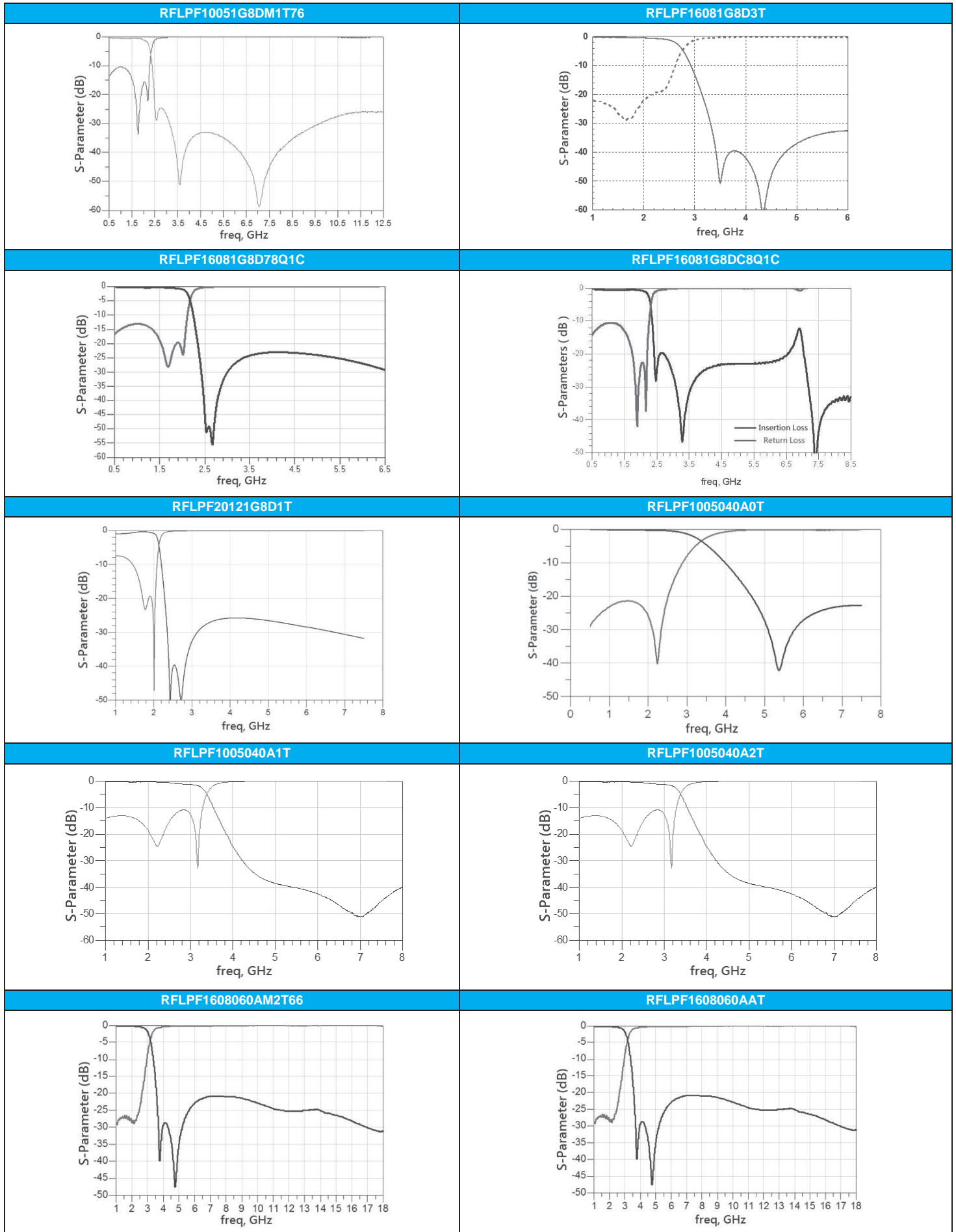

TYPICAL ELECTRICAL CHARACTERISTICS

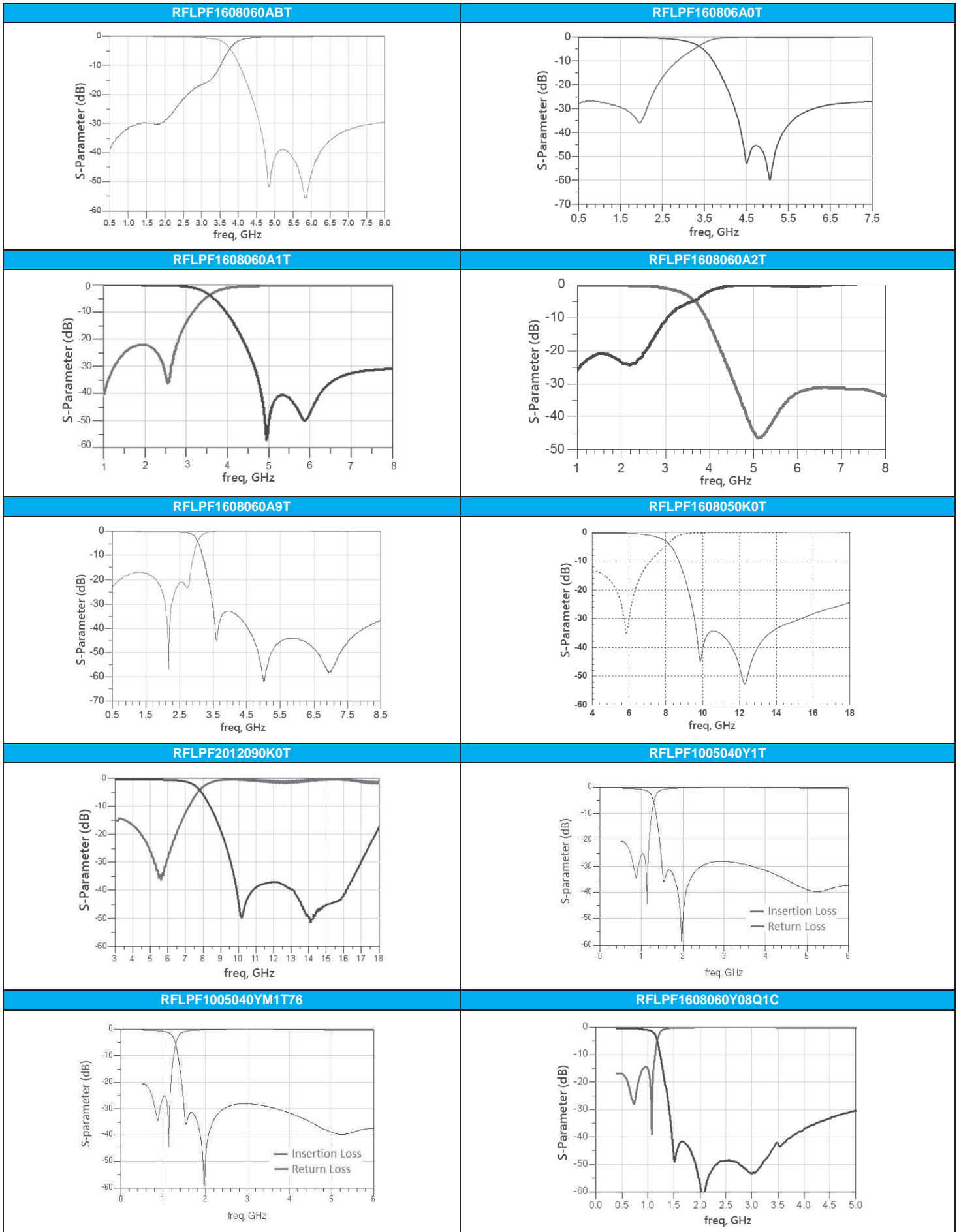

TYPICAL ELECTRICAL CHARACTERISTICS

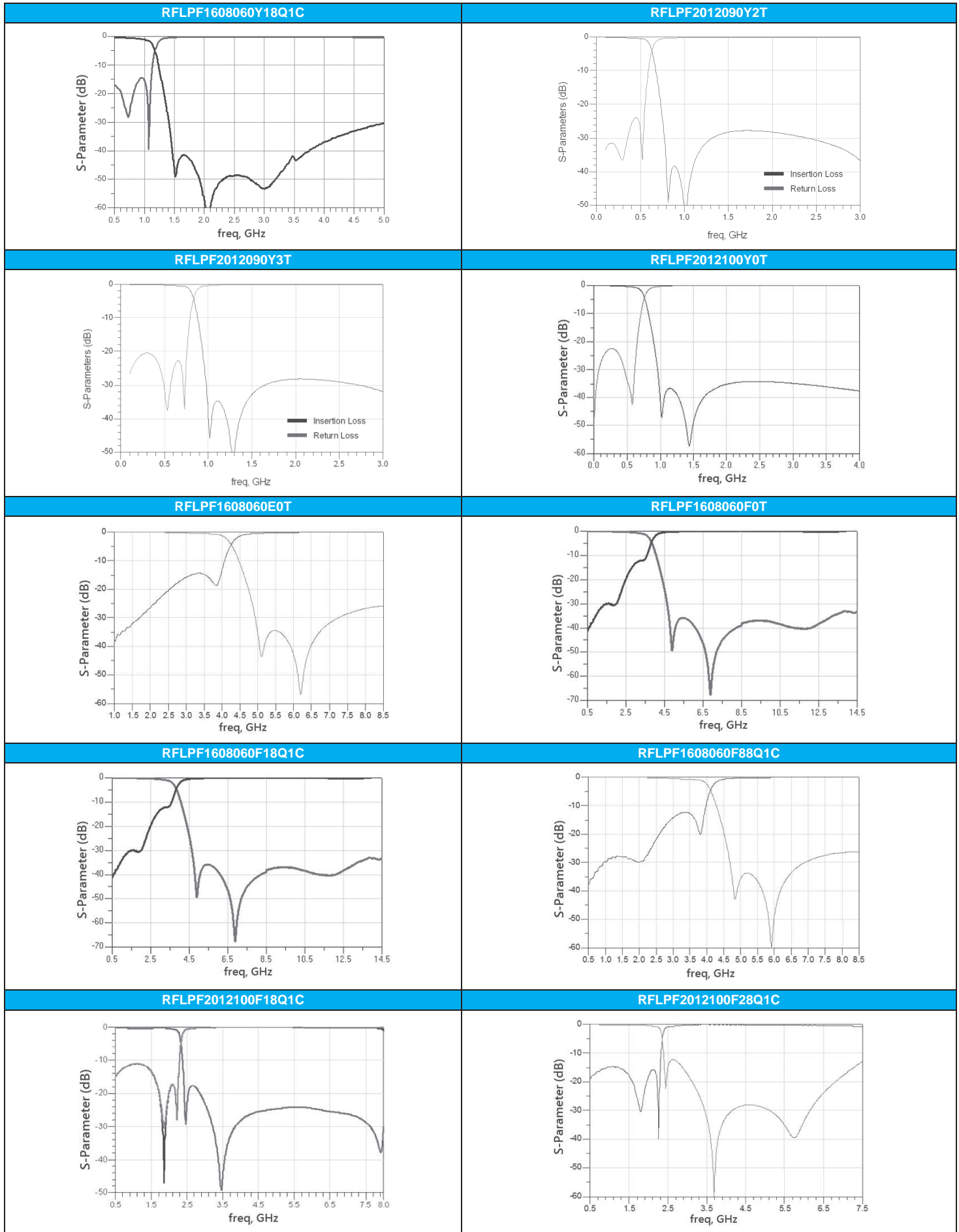

TYPICAL ELECTRICAL CHARACTERISTICS

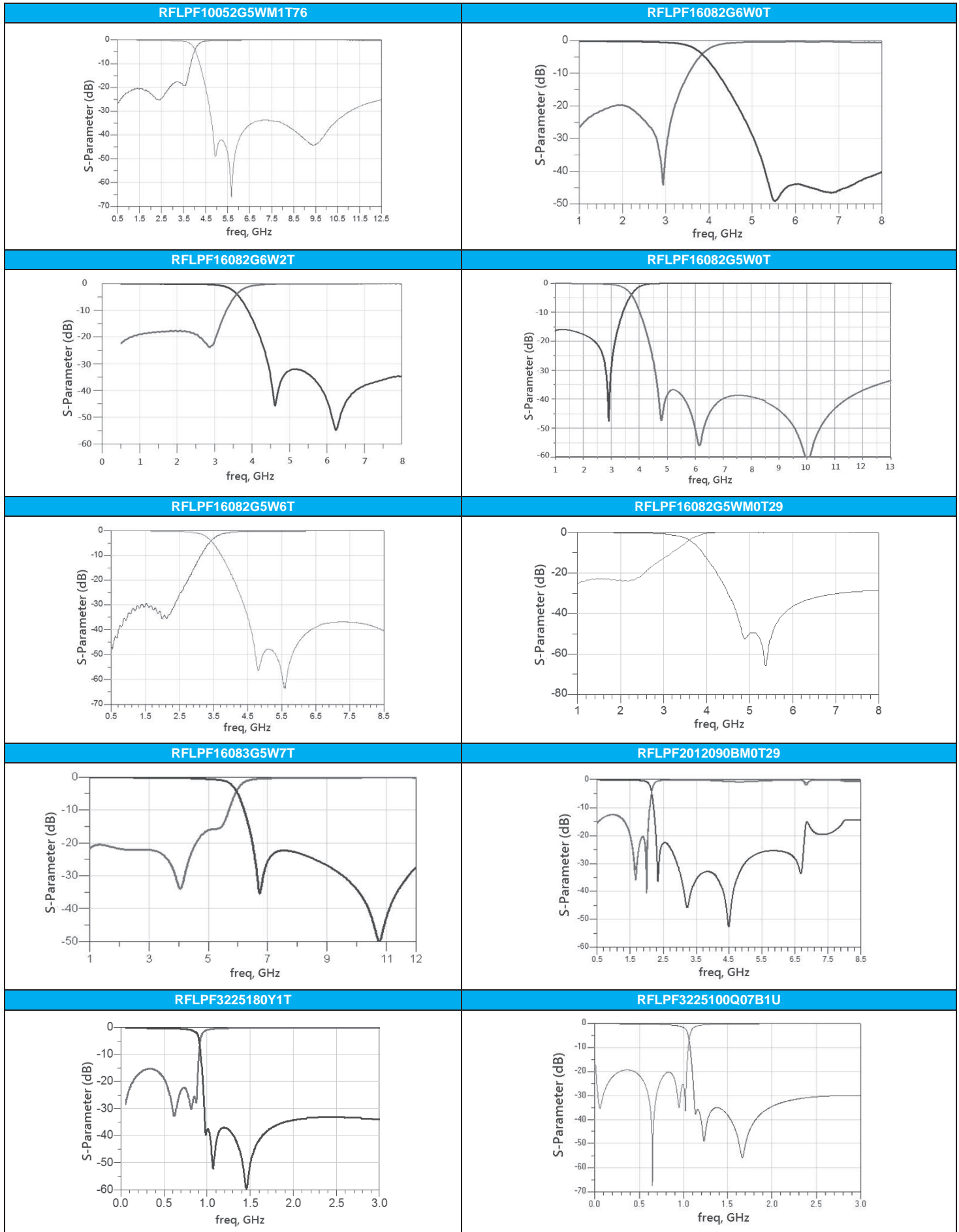

TYPICAL ELECTRICAL CHARACTERISTICS

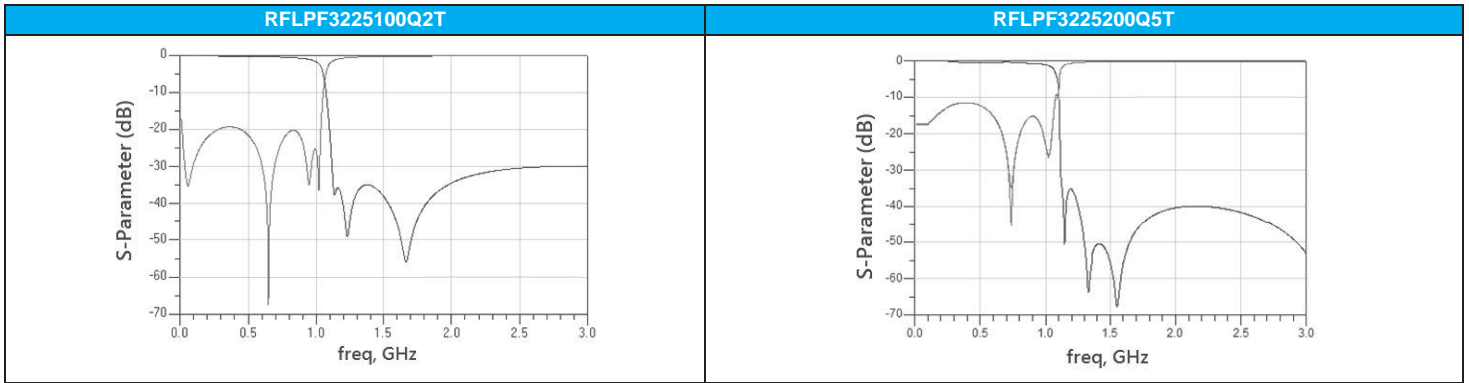

- For more information, please contact with local sales representative
- All specifications are subject to change without notice

HIGH FREQUENCY MULTILAYER HIGH PASS FILTER

■ **STRUCTURE AND PIN ASSOCIATED**

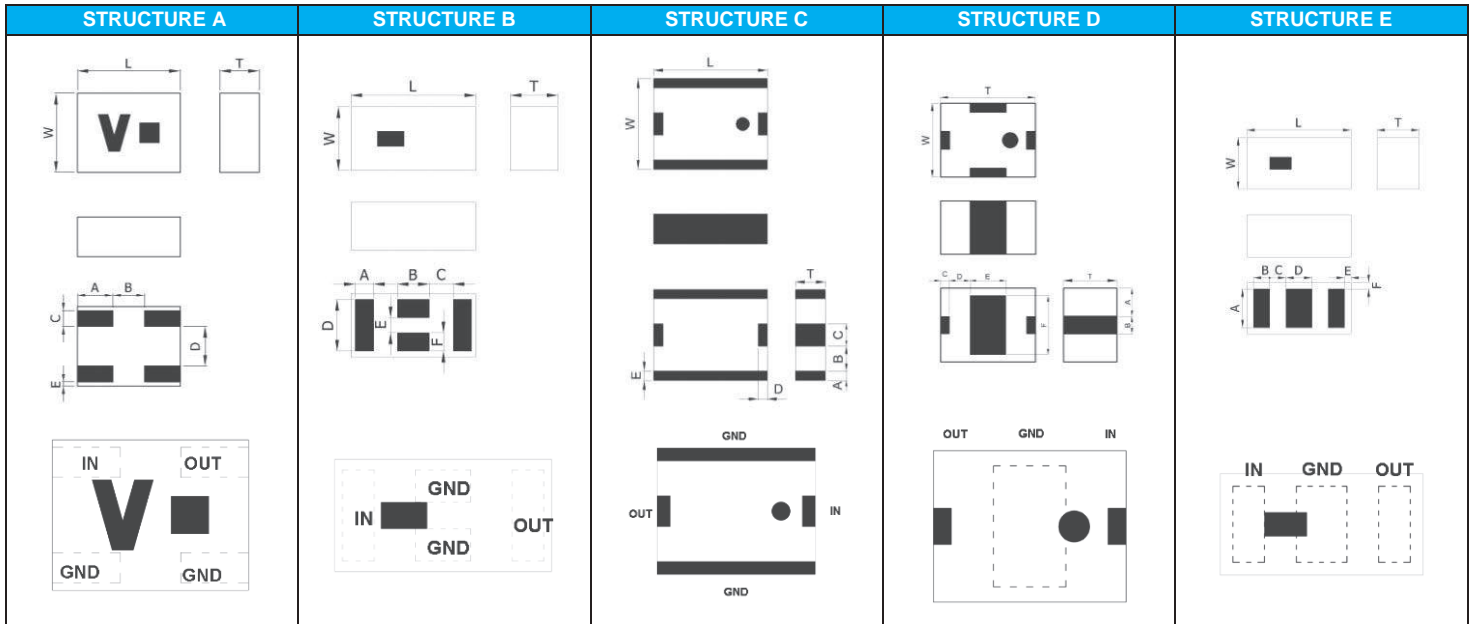

■ **STRUCTURE AND DIMENSION**

Structure/Dimension	L	W	T	A	B	C	D	E	F
A	0.65 ± 0.10	0.50 ± 0.10	0.4 max.	0.225 ± 0.10	0.20 ± 0.05	0.10 ± 0.10	0.20 ± 0.05	0.05 ± 0.05	-
B	1.60 ± 0.15	0.80 ± 0.15	0.60 ± 0.1.0	0.23 ± 0.05	0.40 ± 0.10	0.30 ± 0.10	0.65 ± 0.10	0.20 ± 0.05	0.23 ± 0.05
C	2.50 ± 0.20	2.00 ± 0.20	0.90 ± 0.1.0	0.20 ± 0.20	0.55 ± 0.20	0.50 ± 0.20	0.20 ± 0.20	0.20 ± 0.20	-
D	3.20 ± 0.20	2.50 ± 0.20	1.7 max.	0.95 ± 0.20	0.60 ± 0.20	0.30 ± 0.15	0.70 ± 0.15	1.20 ± 0.15	2.00 ± 0.15
E	1.60 ± 0.10	0.80 ± 0.10	0.70 ± 0.1.0	0.73 ± 0.10	0.30 ± 0.10	0.25 ± 0.10	0.40 ± 0.10	0.05 ± 0.05	0.05 ± 0.05

Unit: mm

■ **ELECTRICAL SPECIFICATION**

ISM 2.4/ 5GHz Band Application

Part Number	Frequency Range (MHz)	Insertion Loss (dB)	Attenuation (dB min.)	VSWR (max.)	Size (mm)	Structure
RFHPF2520090L0T	2400~2500	2.0max.(25°C) 2.3max.(-40~+85°C)	30(869~960 MHz) 45(1805~1990 MHz)	2	2.50x2.00x0.90	C
	5150~5825	1.3max.(25°C) 1.6max.(-40~+85°C)	30(869~960 MHz) 45(1805~1990 MHz)	2		

2496 ~ 2690 MHz BAND WORKING FREQUENCY

Part Number	Frequency Range (MHz)	Insertion Loss (dB)	Attenuation (dB min.)	VSWR (max.)	Size (mm)	Structure
RFHPF16082G5W0T	2496~2690	1.2max.(25°C) 1.3max.(-40~+85°C)	25(1710~1995MHz)	2.0	1.6 X 0.8 X 0.6	B
RFHPF16082G5W6T	2300~2690	1.45max.(25°C) 1.65max.(-40~+85°C)	20(1710~1980MHz)	2.0	1.6 X 0.8 X 0.7	E

5GHz BAND WORKING FREQUENCY

Part Number	Frequency Range (MHz)	Insertion Loss (dB)	Attenuation (dB min.)	VSWR (max.)	Size (mm)	Structure
RFHPF0605040K0T	4900~5840	0.60max.(25°C) 0.65max.(-40~+85°C)	14(2400~2500MHz)	1.6	0.65 X 0.5 X 0.4	A
RFHPF0605040K1T	4900~5850	0.65	20(2450~2500MHz)	2.0	0.65 X 0.5 X 0.4	A

MoCA Application

Part Number	Frequency Range (MHz)	Insertion Loss (dB)	Attenuation (dB min.)	VSWR (max.)	Size (mm)	Structure
RFHPF3225170F07B1U	950~2150	2.00max.(25°C) 2.2max.(-40~+85°C)	50(475~675MHz)	2.0	3.2 X 2.5 X 1.7	DC

■ **TYPICAL ELECTRICAL CHARACTERISTICS**

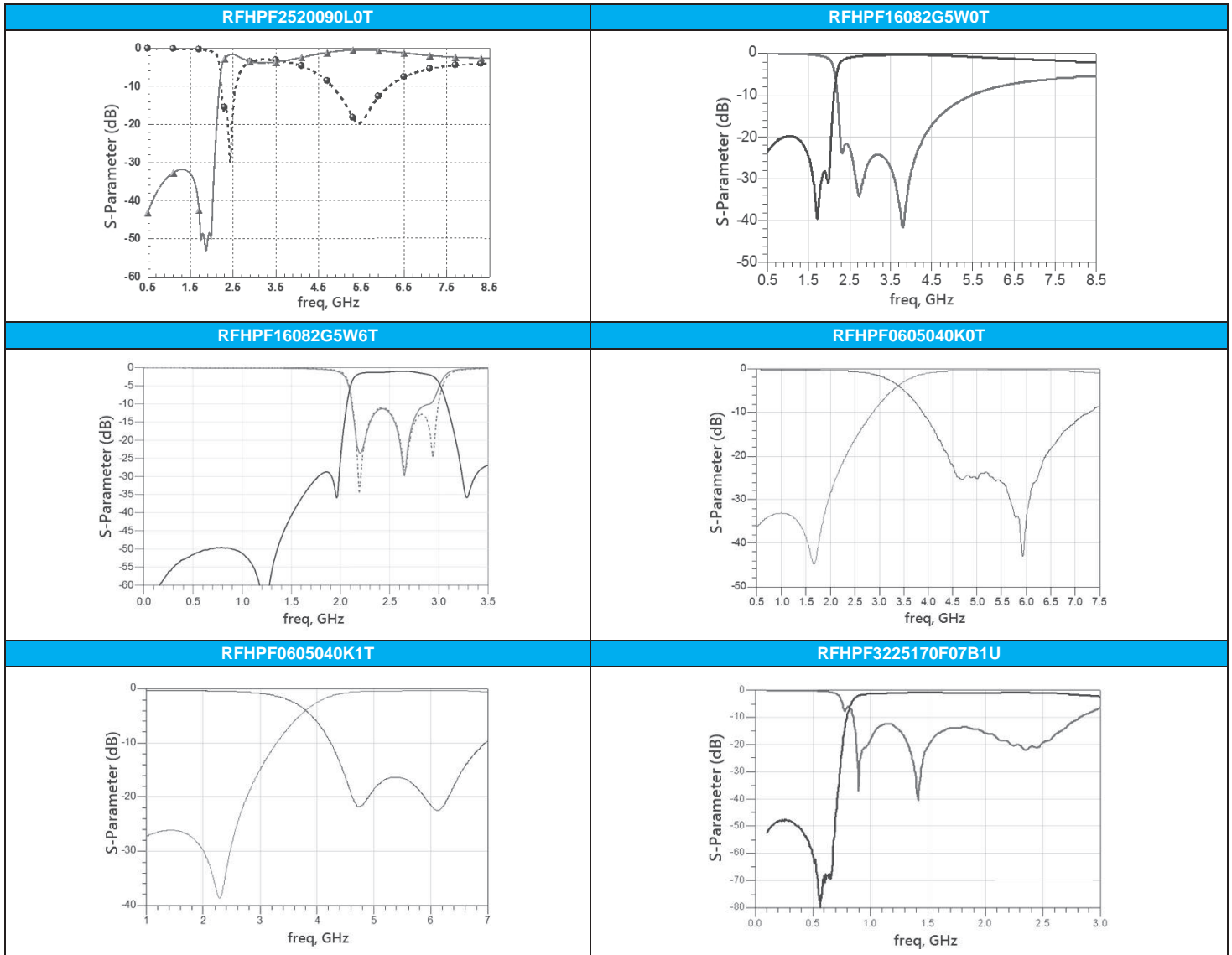

- For more information, please contact with local sales representative
- All specifications are subject to change without notice

BALUN TRANSFORMERS

■ **STRUCTURE AND PIN ASSOCIATED**

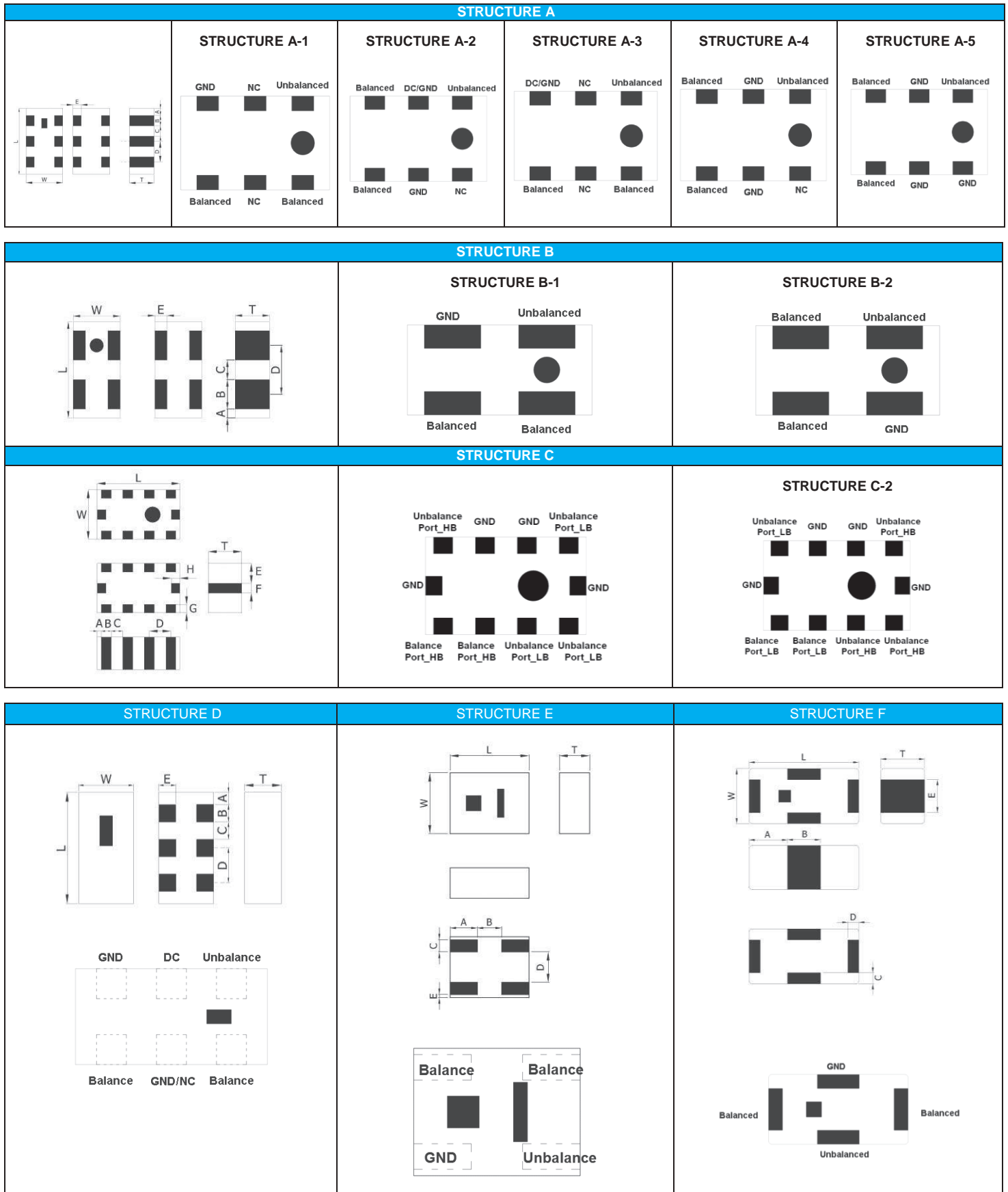

■ **STRUCTURE AND DIMENSION**

Unit: mm

Structure\ Dimension	L	W	T	A	B	C	D	E	F	G	H
A	1.60±0.10	0.85±0.10	0.70±0.10	0.20±0.10	0.20±0.10	0.30±0.10	0.50±0.05	0.50±0.05	-	-	-
	1.60±0.15	0.80±0.10	0.50±0.10	0.175±0.15	0.25±0.15	0.25±0.15	0.50±0.15	0.20±0.15	-	-	-
			0.40 max.	0.175±0.15	0.25±0.15	0.25±0.15	0.50±0.15	0.20±0.15	-	-	-
		0.85±0.10	0.60±0.10	0.175±0.15	0.25±0.15	0.25±0.15	0.50±0.15	0.20±0.15	-	-	-
			0.70±0.10	0.175±0.15	0.25±0.15	0.25±0.15	0.50±0.15	-	-	-	-
	0.65±0.10										
	2.00±0.15	1.25±0.15	0.80±0.10	0.20±0.20	0.30±0.20	0.35±0.20	0.65±0.20	-	-	-	-
			0.85±0.10	0.20±0.20	0.30±0.20	0.35±0.20	0.65±0.20	-	-	-	-
			0.80±0.10	0.20±0.15	0.30±0.20	0.35±0.20	0.65±0.20	-	-	-	-
			0.95±0.10	0.20±0.20	0.30±0.20	0.35±0.20	0.65±0.20	-	-	-	-
B	1.00±0.10	0.50±0.10	0.37±0.10	0.10±0.10	0.30±0.10	0.20±0.10	0.50±0.10	0.125±0.10	-	-	-
	1.00±0.10	0.50±0.10	0.40±0.10	0.10±0.10	0.30±0.10	0.20±0.10	0.50±0.10	0.125±0.10	-	-	-
C	2.00±0.10	1.25±0.15	0.90±0.10	0.125±0.10	0.25±0.10	0.25±0.10	0.50±0.10	0.475±0.10	0.30±0.10	0.20±0.15	0.20±0.15
D	1.60±0.15	0.80±0.15	0.50±0.10	0.175±0.10	0.25±0.10	0.25±0.10	0.50±0.10	0.25±0.10	-	-	-
E	0.65±0.10	0.50±0.10	0.40±0.10	0.20±0.05	0.20±0.05	0.025±0.025	0.10±0.05	0.25±0.05	0.025±0.025	-	-
F	1.00±0.10	0.50±0.10	0.5 max.	0.35±0.10	0.30±0.10	0.15±0.10	0.15±0.10	0.30±0.10	-	-	-

■ **ELECTRICAL SPECIFICATION**

ISM Band 2.4GHz APPLICATION

Part Number	Frequency Range (MHz)	Impedance(Ω)		Return Loss (dB) Min.	Insertion Loss (dB)	Amplitude Difference (dB) Max.	Phase Difference	Size(mm)	Structure
		Unbalance	Balance						
RFBLN1005040A3T	2400~2500	50	Conjugate match to AR6003 chipset	10	1.4	2.0	180± 10	1.00x0.50x0.40	B-1
RFBLN1005040A6T	2400~2500	50	50	10	0.8	2.0	180± 10	1.00x0.50x0.40	B-2
RFBLN1608050AAT	2400~2500	50	Conjugate match to AR6003 chipset	10	1.2	2.0	180± 10	1.60x0.80x0.50	D
RFBLN1608060AM1T59	2400~2500	50	200	10	1.2	2.0	180± 10	1.60x0.80x0.65	A-3
RFBLN1608050AM8T62	2400~2500	50	50	10	1.2	2.0	180± 10	1.60x0.80x0.50	A-2
RFBLN1608050AM0T63	2400~2500	50	50	10	1.0	1.0	180± 10	1.60x0.80x0.55	A-2
RFBLN1608050AM6T30	2400~2500	50	35	10	1.0	1.0	180± 10	1.60x0.80x0.55	A-2
RFBLN1608060AC6T40	2400~2500	50	Conjugate match to TI CC26XX Chipset	10	1.6(25°C) 1.8(-40~+85°C)	2.3	180± 18	1.60x0.80x0.60	A-5
RGBLN1608070A1T	2400~2500	50	100	10	1.5	2.0	180± 15	1.60x0.85x0.70	A-1
RFBLN1608070A3T	2400~2500	50	100	10	1.0	2.0	180± 10	1.60x0.85x0.70	A-1
RFBLN1608070A4T	2400~2500	50	100	10	1.0	2.0	180± 10	1.60x0.80x0.70	A-1
RGBLN1608070A5T	2400~2500	50	100	10	1.2	2.0	180± 10	1.60x0.80x0.70	A-2
RGBLN2012080A5T	2400~2500	50	50	12	1.0	1.0	180± 10	2.00x1.25x0.85	A-2
RFBLN2012080A7T	2400~2500	50	100	10	1.0	2.0	180± 10	2.00x1.25x0.80	A-2
RGBLN2012090A0T	2400~2500	50	50	10	1.2	2.0	180± 10	2.00x1.25x0.95	A-2
RFBLN2012090A1T	2400~2500	50	100	10	1.0	2.0	180± 10	2.00x1.25x0.95	A-2

ISM Band 5GHz APPLICATION

Part Number	Frequency Range (MHz)	Impedance(Ω)		Return Loss (dB) Min	Insertion Loss (dB)	Amplitude Difference (dB) Max.	Phase Difference	Size (mm)	Structure
		Unbalance	Balance						
RFBLN1005040K1T	4900~5950	50	50	10	1.2	2.0	180± 10	1.00x0.50x0.40	B-2
RFBLN1005040K5T	4900~5950	50	100	10	0.55(25°C) 0.75(-40~+85°C)	2.5	180± 10	1.00x0.50x0.40	B-2
RFBLN1005040K6T	4900~5950	50	50	10	0.60(25°C) 0.80(-40~+85°C)	2.5	180± 15	1.00x0.50x0.40	B-2
RFBLN2012090K0T	4900~5900	50	50	10	1.1	2.0	180± 10	2.00x1.25x0.95	A-4
RFBLN2012090K1T	4900~5900	50	100	10	1.2	2.0	180± 10	2.00x1.25x0.95	A-4

LTE Band APPLICATION

Part Number	Frequency Range (MHz)	Impedance(Ω)		Return Loss (dB)Min	Insertion Loss (dB)	Amplitude Difference (dB) Max.	Phase Difference	Size (mm)	Structure
		Unbalance	Balance						
RFBLN0605040Y1T	717~821	50	100	15	0.55(25°C) 0.65(-40~+85°C)	2.0	180± 10	0.65x0.50x0.40	E
RFBLN0605040YM9T16	729~821	50	100	10	0.55(25°C) 0.65(-40~+85°C)	2.0	180± 10	0.65x0.50x0.40	E
RFBLN0605040Y09FNH	729~869	50	100	15	0.55(25°C) 0.65(-40~+85°C)	2.5	180± 10	0.65x0.50x0.40	E
RFBLN1005040YM1T69	703~803	50	100	10	0.80	2.0	180± 12	1.00x0.50x0.40	F
RFBLN06050G9D0T	729~960	50	100	15	0.85(25°C) 0.95(-40~+85°C)	4.8	180± 10	0.65x0.50x0.40	E
RFBLN16080G9D2T	699~960	50	100	10	1.05(25°C) 1.15(-40~+85°C)	2.5	180± 15	1.60x0.80x0.70	A-4
RFBLN16080G9D3T	824~894	50	50	10	1.2	1.0	180± 10	1.60x0.80x0.60	A-2
RFBLN20120G9D0T	824~894	50	100	10	1.2	1.0	180± 10	2.00x1.25x0.90	A-2
RFBLN20120G9D5T	880~960	50	100	10	1.1	1.0	180± 10	2.00x1.25x0.90	A-2
RFBLN06051G8DM1T69	1805~1990	50	100	10	0.60(25°C) 0.65(-40~+85°C)	1.8	180± 10	0.65x0.50x0.40	E
RFBLN06051G8D1T	1805~2170	50	100	10	0.65(25°C) 0.70(-40~+85°C)	3.0	180± 15	0.65x0.50x0.40	E
RFBLN20121G8D1T	1700~2000	50	100	10	1.0	2.0	180± 10	2.00x1.25x0.95	A-2
RFBLN10051G9D0T	1805~2020	50	100	10	0.65(25°C) 0.75(-40~+85°C)	2.0	180± 10	1.00x0.50x0.40	B-2
RFBLN10051G9D1T	1805~1990	50	100	10	0.60(25°C) 0.70(-40~+85°C)	2.2	180± 12	1.00x0.50x0.40	B-2
RFBLN1005040F0T	1805~2170	50	100	10	0.70(25°C) 0.80(-40~+85°C)	1.2	180± 15	1.00x0.50x0.40	F
RFBLN1608070F48Q1C	673~2700	50	100	10	1.7(25°C) 2.0(-40~+85°C)	1.5	180± 17	1.60x0.80x0.70	A-4
RFBLN2012090F0T	1920~1980 2110~2170	50	50	10	1.0	2.0	180± 10	2.00x1.25x0.95	A-2
RFBLN0605040E0T	2000~2500	50	100	10	0.60(25°C) 0.70(-40~+85°C)	3.5	180± 10	0.65x0.50x0.40	E
RFBLN2012090E0T	1500~3000	50	100	10	1.0	2.0	180± 10	2.00x1.25x0.90	A-4
RFBLN06052G5WM9T16	2300~2690	50	100	10	0.55(25°C) 0.65(-40~+85°C)	2.5	180± 10	0.65x0.50x0.40	E
RFBLN10052G5WM9T16	2300~2690	50	100	10	0.55(25°C) 0.65(-40~+85°C)	2.5	180± 10	1.00x0.50x0.40	B-1
RFBLN10052G5W37N2T	2300~2690	50	100	10	0.65(25°C) 0.75(-40~+85°C)	2.5	180± 10	1.00x0.50x0.40	B-2
RFBLN16082G5W0T	2300~2700	50	100	10	1.1	2.0	180± 10	1.60x0.80x0.70	A-2
RFBLN16082G5W38Q1C	2300~2700	50	100	10	0.55(25°C) 0.65(-40~+85°C)	1.0	180± 10	1.60x0.80x0.40	A-4
RFBLN16082G5W4T	2300~2700	50	50	10	1.2	2.0	180± 10	1.60x0.80x0.50	A-2

GSM 850/ GSM 900/ DCS1800/ PCS1900 APPLICATION

Part Number	Frequency Range (MHz)	Unbalance	Balance	Return Loss (dB) Min	Insertion Loss (dB)	Amplitude Difference (dB) Max	Attenuation (dB min.)	Phase Difference	Size(mm)	Structure
RFBLN2012090BM5T25	869~960	50	200	10	1.1	2.0	10(1738~1920MHz) 20(2400~2500MHz) 20(2607~2880MHz)	180± 10	2.00x1.25x0.95	C-1
	1805~2025	50	200	10	1.8	2.0	15(2400~2500MHz) 20(3610~3980MHz) 20(5415~5970MHz)	180± 15		
RFBLN2012090BS0T53	869~960	50	200	10	1.1(25°C) 1.3(-40~+85°C)	2.0	10(1738~1920MHz) 20(2400~2500MHz) 20(2607~2880MHz)	180± 15	2.00x1.25x0.95	C-1
	1805~1990	50	200	10	1.6(25°C) 1.8(-40~+85°C)	2.0	15(2400~2500MHz) 15(3610~3980MHz) 20(5415~5970MHz)	180± 15		
RFBLN2012090BS0T50	869~960	50	200	10	1.1(25°C) 1.3(-40~+85°C)	2.0	10(1738~1920MHz) 20(2400~2500MHz) 20(2607~2880MHz)	180± 15	2.00x1.25x0.95	C-2
	1805~2025	50	200	10	1.8(25°C) 2.0(-40~+85°C)	2.0	15(2400~2500MHz) 15(3610~3980MHz) 20(5415~5970MHz)	180± 15		

■ TYPICAL ELECTRICAL CHARACTERISTICS

RFBLN1005040A3T

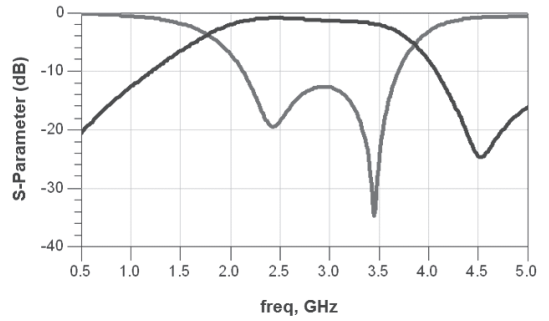
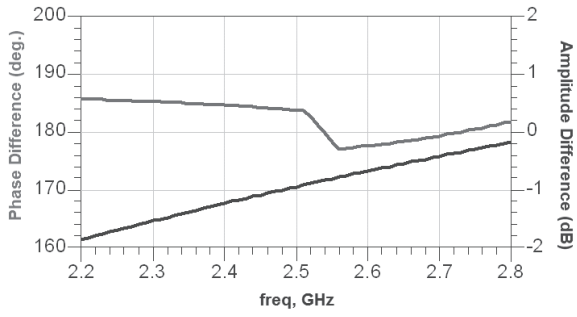

RFBLN1608060AM1T59

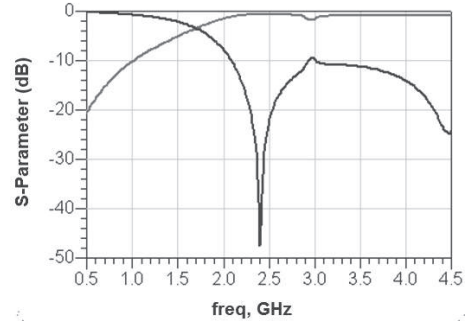
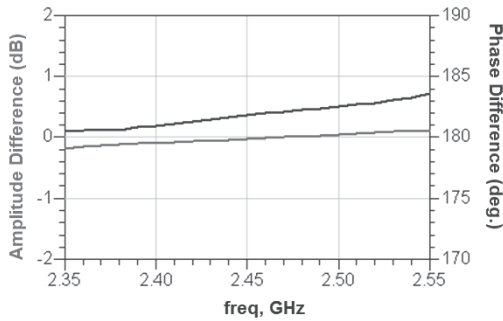

RFBLN1608050AM8T62

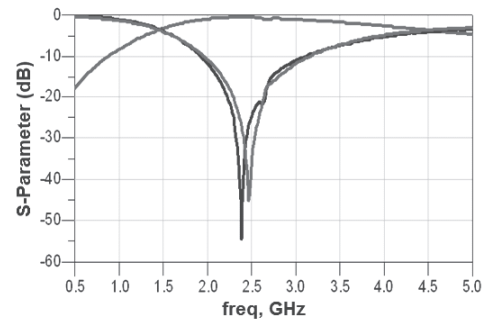
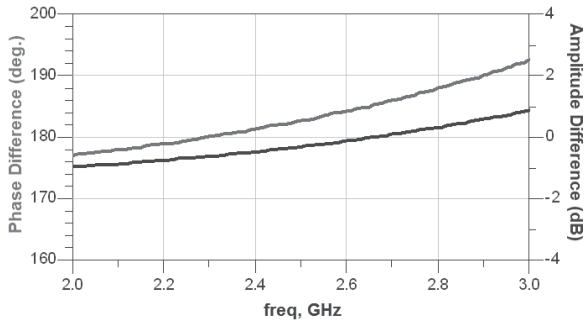

RFBLN1608050AM0T63

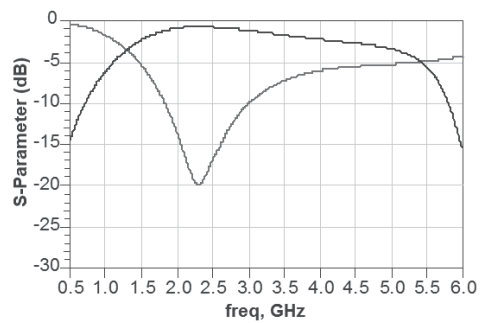
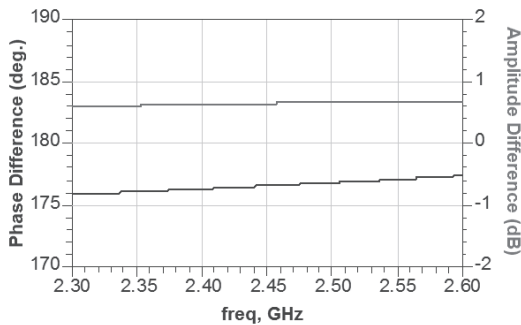

RFBLN2012080A7T

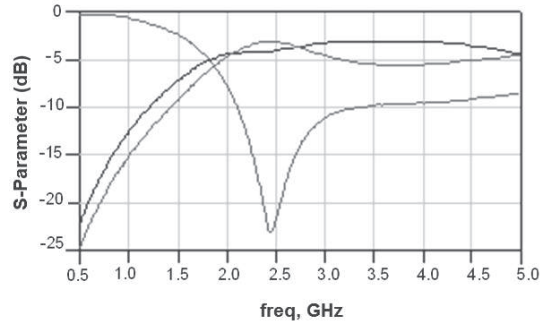
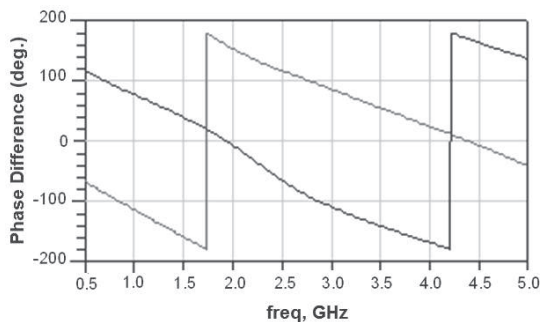

TYPICAL ELECTRICAL CHARACTERISTICS

RGBLN2012090A0T

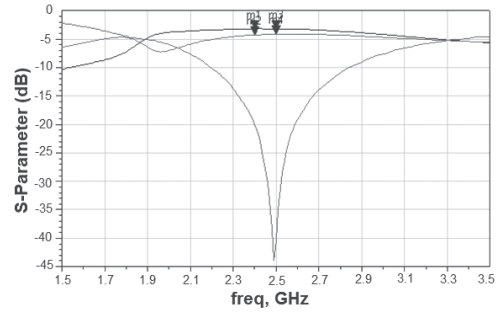
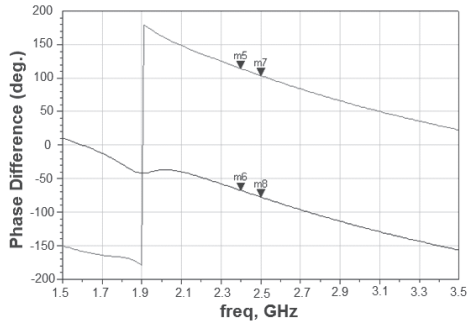

RFBLN1005040K1T

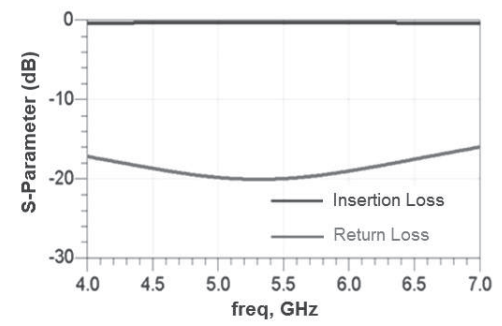
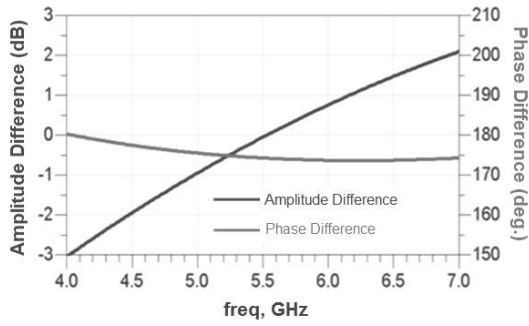

RFBLN1005040K5T

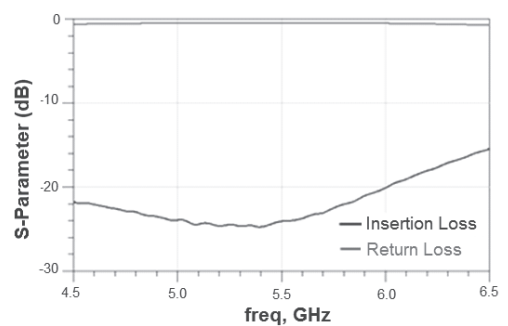
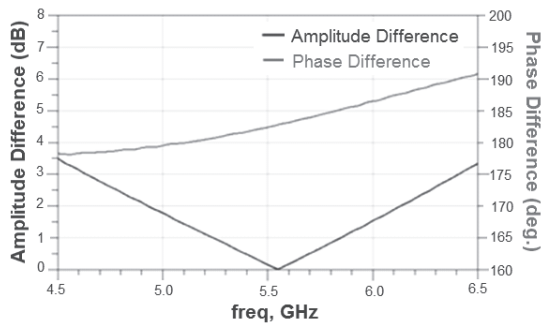

RFBLN0605040Y1T

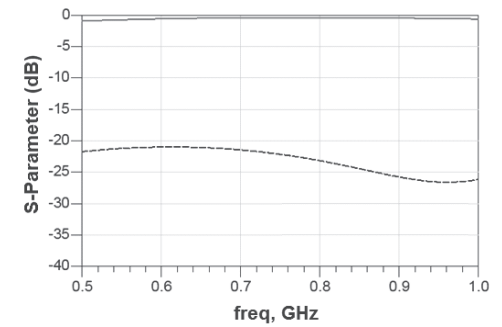
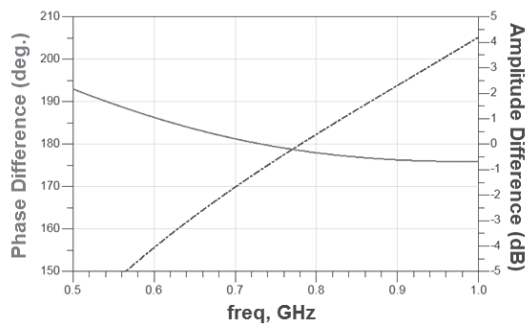

RFBLN0605040YM9T16

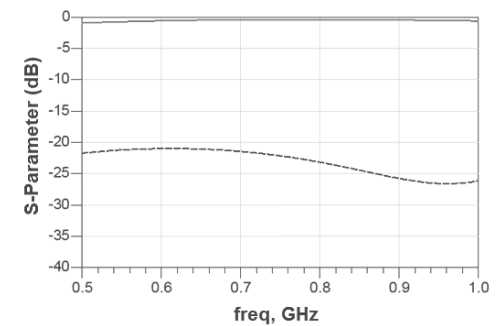
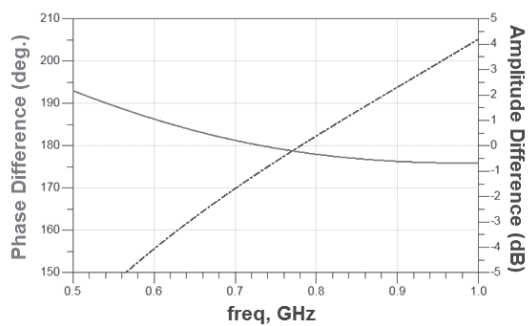

TYPICAL ELECTRICAL CHARACTERISTICS

RFBLN0605040Y09FNH

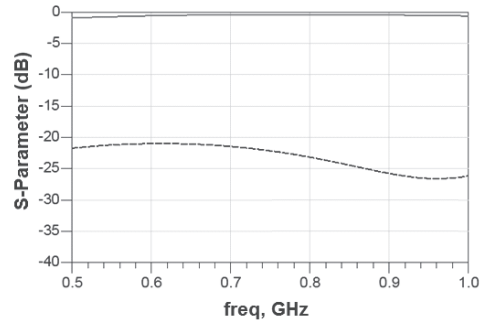
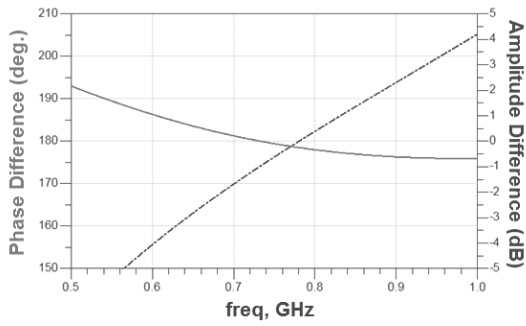

RFBLN1005040YM1T69

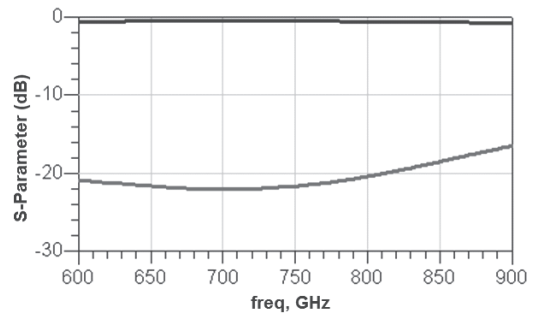
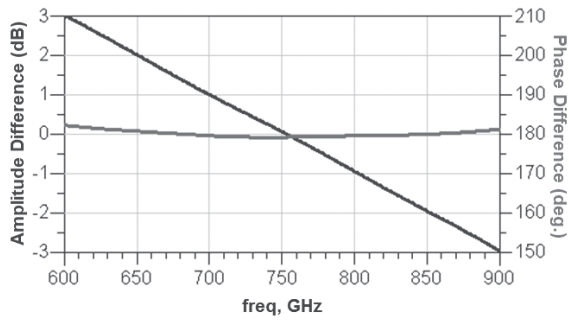

RFBLN06050G9D0T

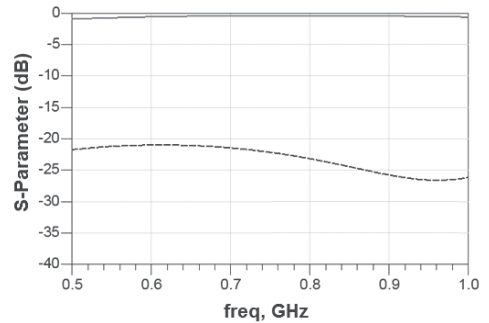
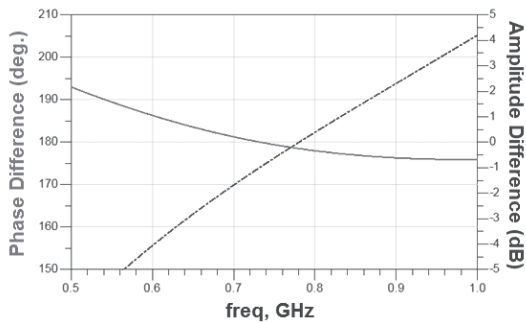

RFBLN16080G9D2T

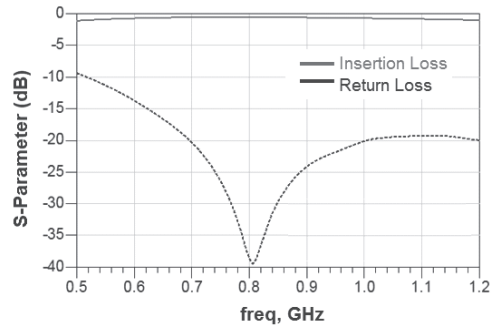
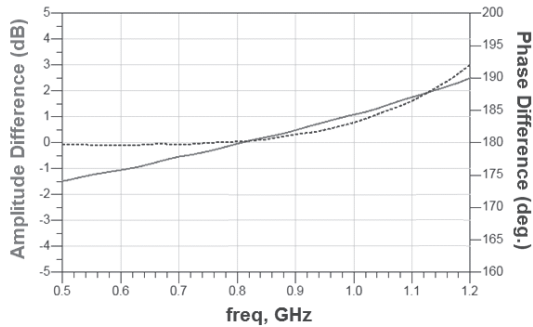

RFBLN16080G9D3T

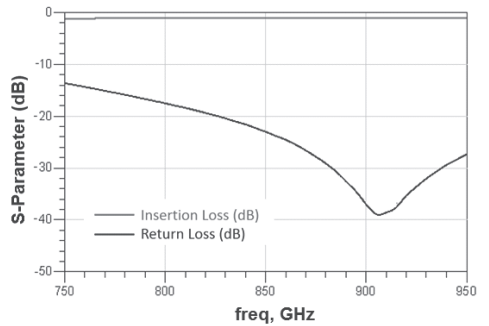
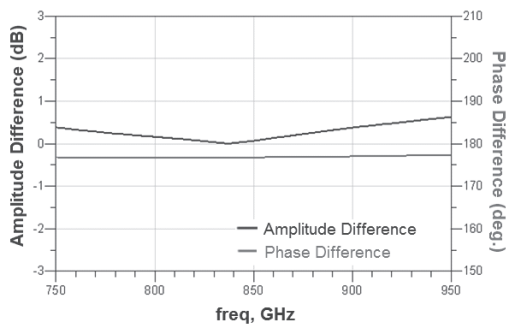

TYPICAL ELECTRICAL CHARACTERISTICS

RFBLN20120G9D0T

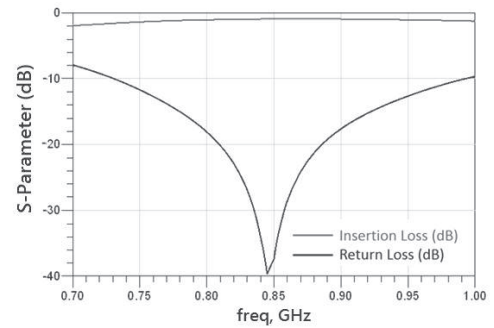
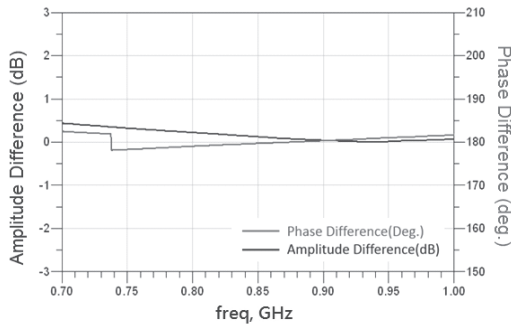

RFBLN20120G9D5T

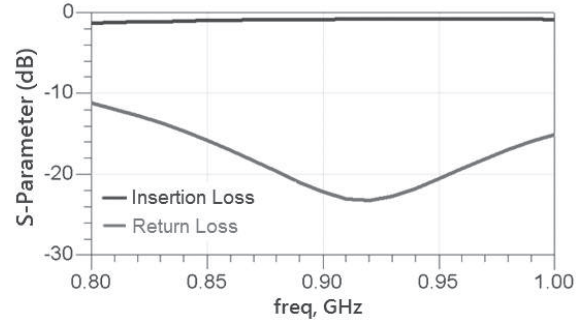
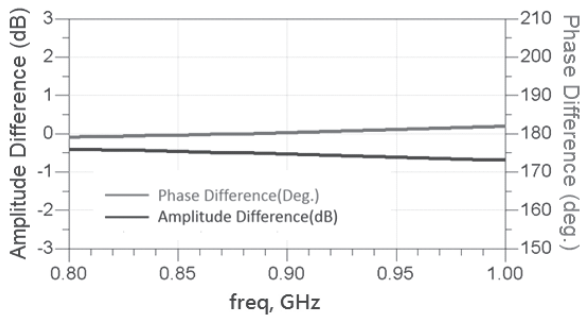

RFBLN06051G8DM1T69

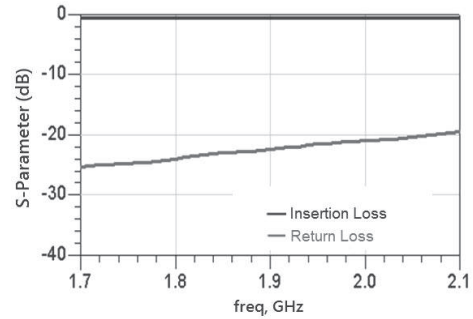
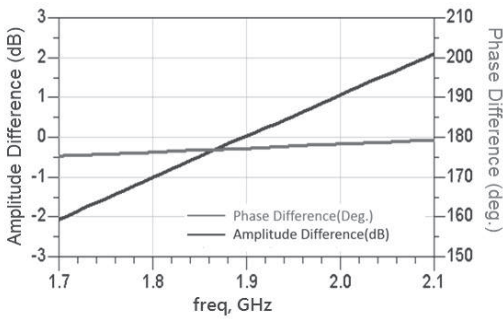

RFBLN06051G8D1T

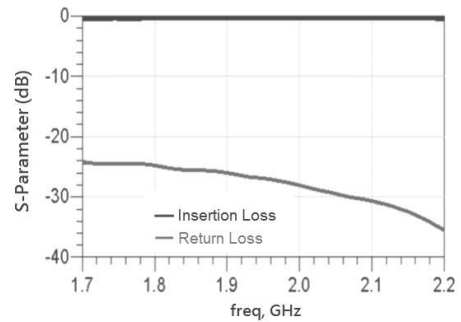
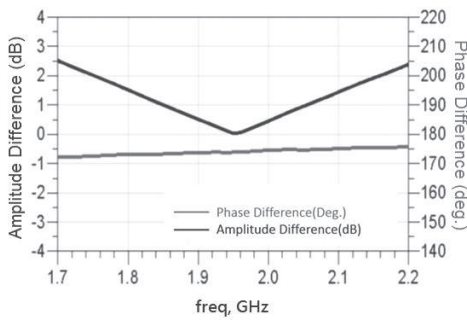

RFBLN20121G8D1T

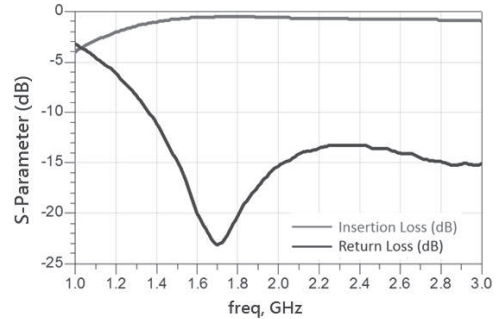
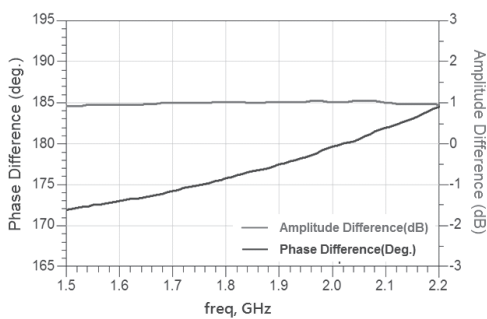

TYPICAL ELECTRICAL CHARACTERISTICS

RFBLN10051G9D0T

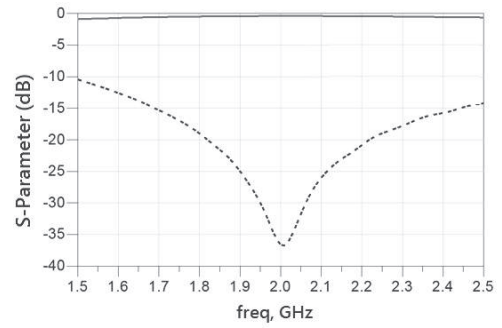
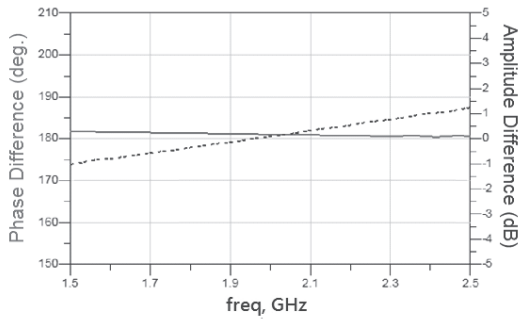

RFBLN10051G9D1T

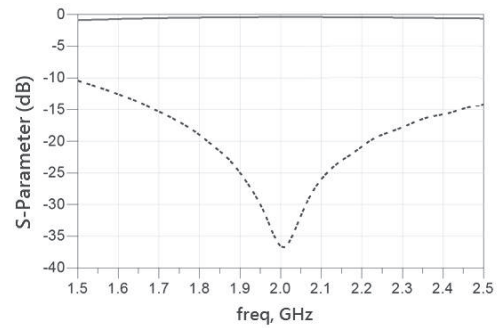
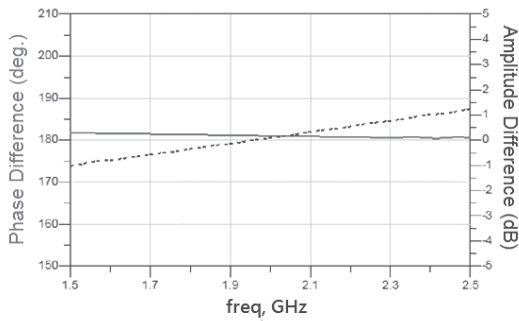

RFBLN1005040F0T

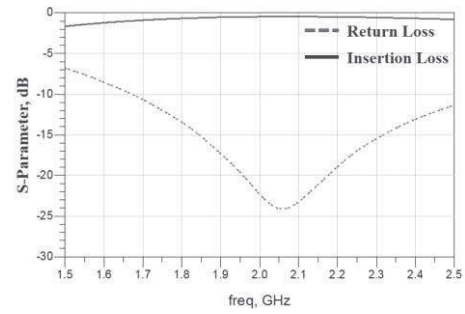
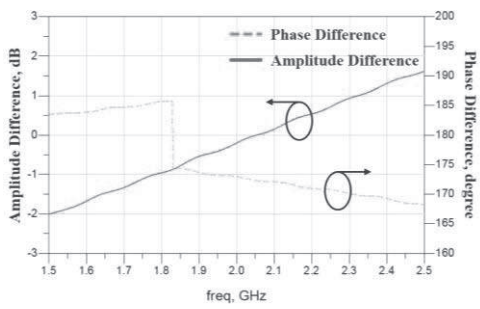

RFBLN1608070F48Q1C

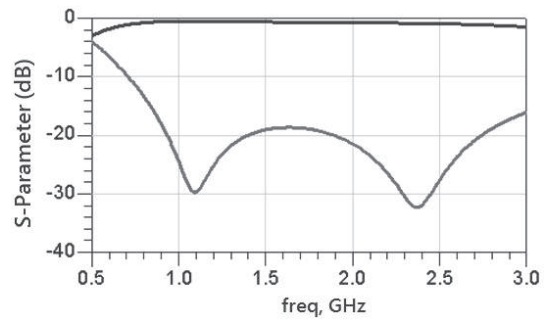
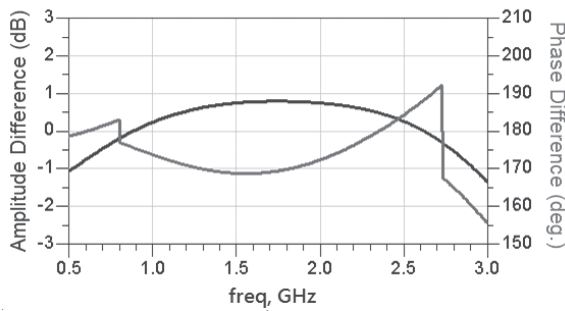

RFBLN2012090F0T

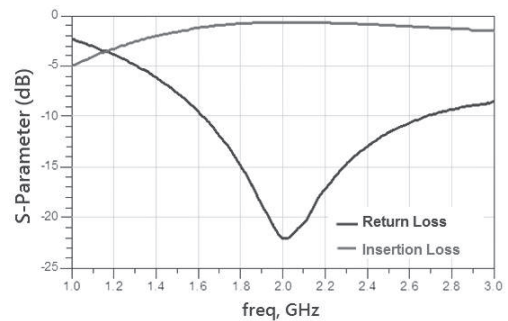
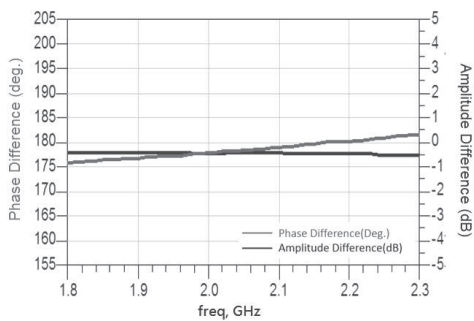

TYPICAL ELECTRICAL CHARACTERISTICS

RFBLN0605040E0T

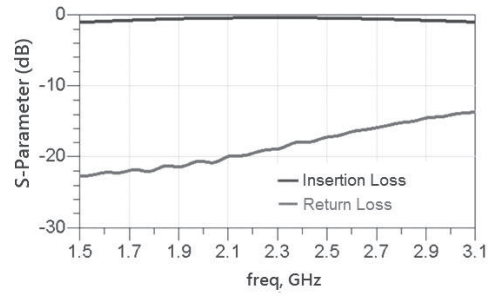
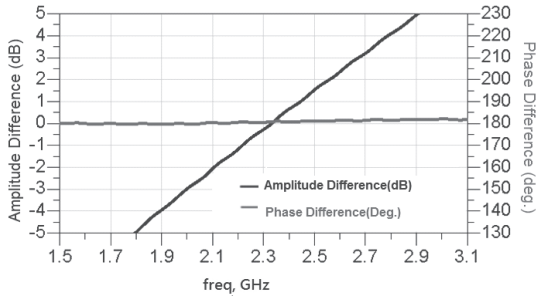

RFBLN2012090E0T

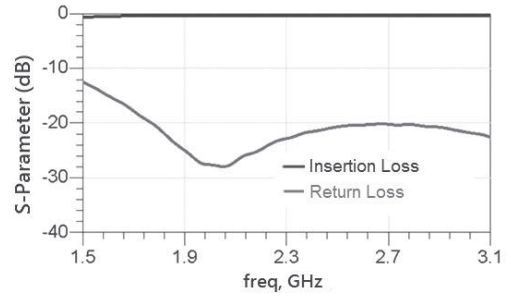
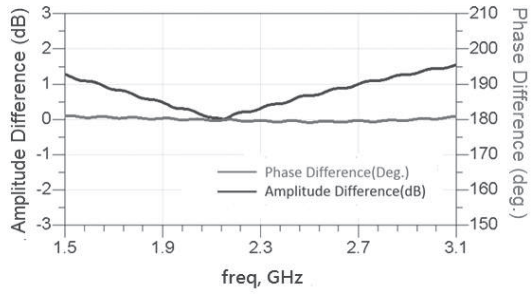

RFBLN06052G5WM9T16

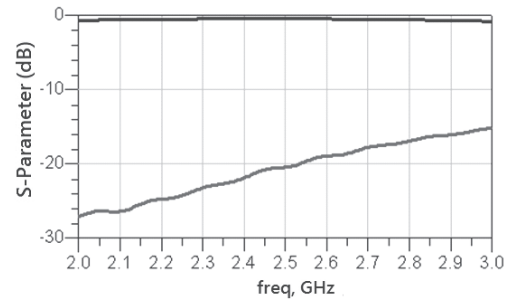
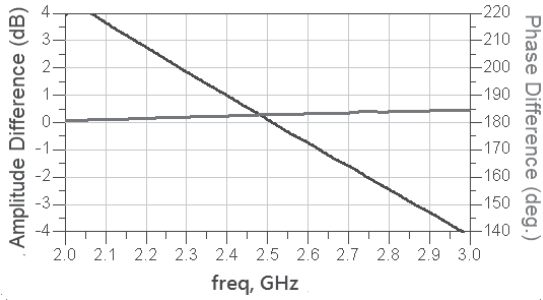

RFBLN10052G5WM9T16

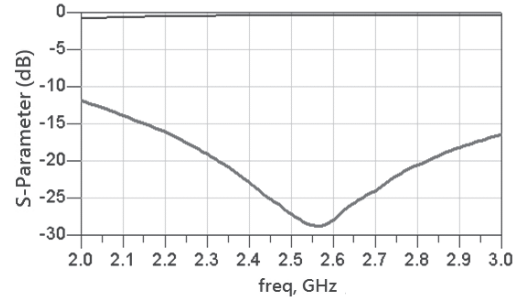
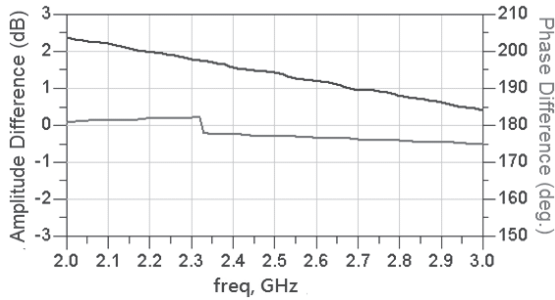

RFBLN10052G5W37N2T

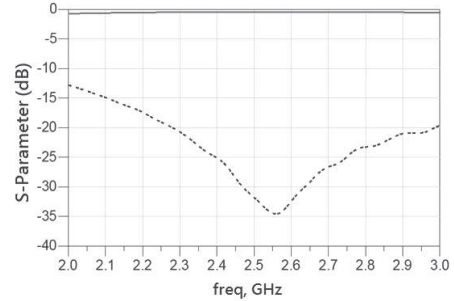
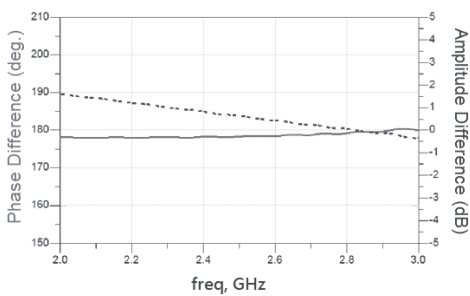

TYPICAL ELECTRICAL CHARACTERISTICS

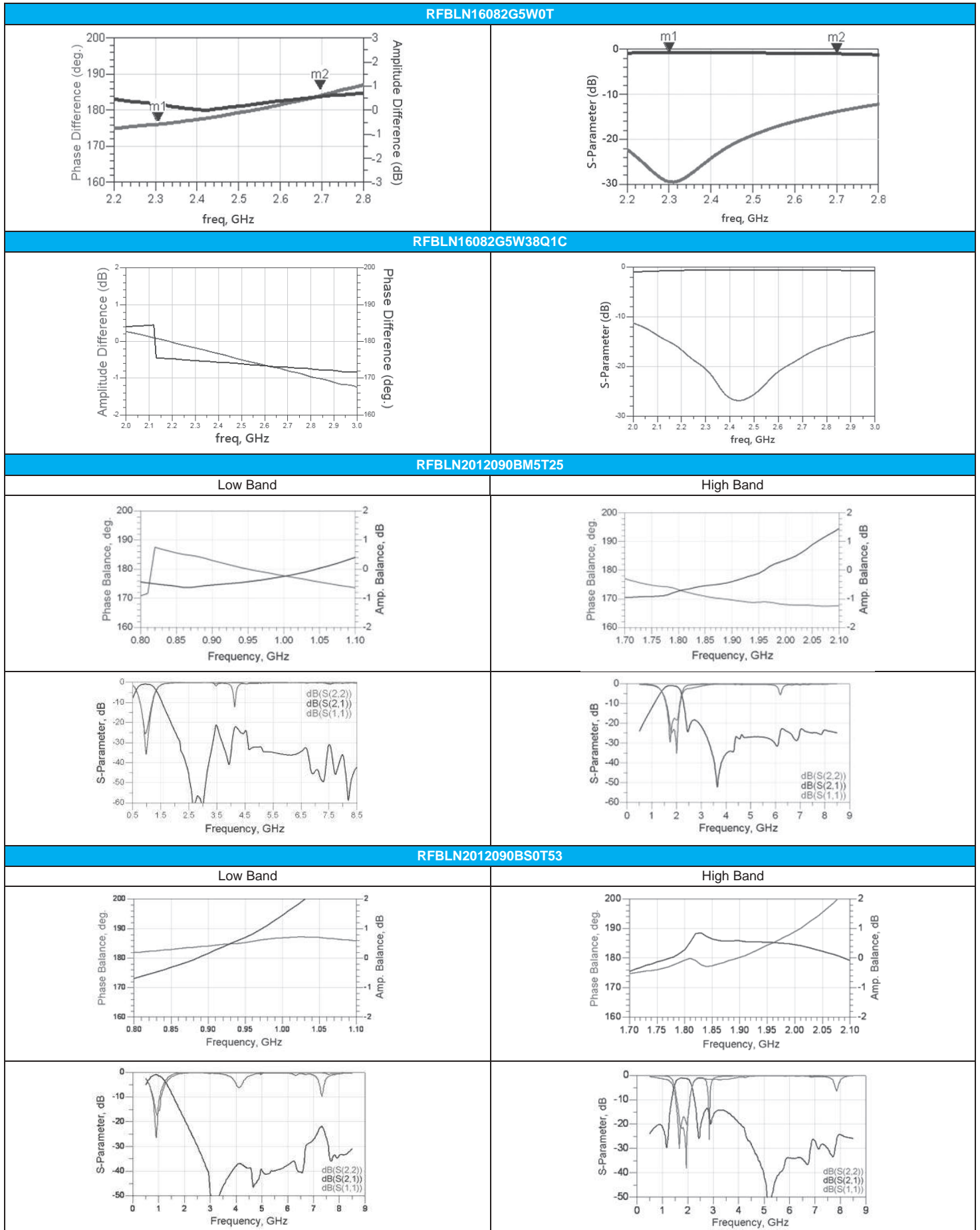

- For more information, please contact with local sales representative
- All specifications are subject to change without notice

DIPLEXER

■ **STRUCTURE AND PIN ASSOCIATED**

STRUCTURE A				
	<p>STRUCTURE A-1</p> <p>GND Common GND</p> <p>High Band GND Low Band</p>	<p>STRUCTURE A-2</p> <p>GND Common GND</p> <p>Low Band GND High Band</p>	<p>STRUCTURE A-3</p> <p>Low Band GND High Band</p> <p>GND Common GND</p>	<p>STRUCTURE A-4</p> <p>High Band GND Low Band</p> <p>GND Common GND</p>
	<p>STRUCTURE B</p>	<p>STRUCTURE C</p>	<p>STRUCTURE D</p>	<p>STRUCTURE E</p>
<p>STRUCTURE B-1</p>	<p>STRUCTURE C-1</p> <p>Low Band GND High Band</p> <p>GND Common GND</p>	<p>STRUCTURE D-1</p> <p>Low Band GND High Band</p> <p>GND Common GND</p>	<p>STRUCTURE E-1</p> <p>Common GND GND Low Band</p>	
<p>STRUCTURE B-2</p> <p>GND</p> <p>High Band Low Band</p> <p>Common</p>	<p>STRUCTURE C-2</p> <p>GND Common GND</p> <p>High Band GND Low Band</p>	<p>STRUCTURE D-1</p> <p>High Band GND Low Band</p> <p>GND Common GND</p>	<p>STRUCTURE E-2</p> <p>GND Common GND High Band</p>	
<p>STRUCTURE F</p>	<p>STRUCTURE G</p>	<p>Low Band GND High Band</p> <p>NC GND ANT GND</p>		

■ **STRUCTURE AND DIMENSION**

Unit: mm

Structure\ Dimension	L	W	T	A	B	C	D	E	F
A	1.60±0.15	0.80±0.15	0.60±0.10	0.175±0.15	0.25±0.15	0.25±0.15	0.50±0.15	0.20±0.15	-
	2.00±0.10	1.25±0.20	0.55±0.15	0.20±0.15	0.30±0.15	0.35±0.15	0.65±0.15	0.20±0.10	-
	2.00±0.15	1.25±0.15	0.95±0.10	0.20±0.20	0.30±0.20	0.35±0.20	0.65±0.20	-	-
B	1.60±0.15	0.80±0.15	0.60±0.10	0.65±0.15	0.30±0.15	0.20±0.15	0.20±0.15	0.25±0.15	0.30±0.15
C	2.00±0.15	1.25±0.15	0.70±0.10	0.35±0.10	0.30±0.10	0.65±0.10	0.60±0.10	0.275±0.10	-
			0.90±0.10	0.35±0.10	0.30±0.10	0.65±0.10	0.60±0.10	0.275±0.10	-
	2.50±0.15	2.00±0.15	0.80±0.15	0.30±0.15	0.35±0.15	0.65±0.15	0.75±0.15	0.525±0.15	-
D	1.60±0.15	0.80±0.15	0.60±0.10	0.175±0.15	0.25±0.15	0.25±0.15	0.50±0.15	0.20±0.15	-
E	2.50±0.15	2.00±0.15	0.70±0.10	0.30±0.10	0.40±0.10	0.60±0.10	1.10±0.10	-	-
F	2.50±0.15	2.00±0.15	1.0max.	0.375±0.15	0.25±0.15	0.25±0.15	0.50±0.15	0.20±0.15	-
G	1.60±0.15	0.80±0.15	0.60±0.10	0.65±0.15	0.30±0.15	0.20±0.15	0.20±0.15	0.25±0.15	0.30±0.15

■ **ELECTRICAL SPECIFICATION**

ISM Band 2.4GHz/5GHz APPLICATION

Part Number	Frequency (MHz)	Impedance (Ω)	Insertion Loss (dB)	Attenuation (dB)	Return Loss (dB) Min	Isolation	Size (mm)	Structure
RFDIP1608060L0T	2400~2500	50	0.8	18(4800~5000MHz) 20(7200~7500MHz)	10	-	1.60x0.80x0.60	A-1
	4900~5900	50	1.2	20(3700~3900MHz) 20(1800~2500MHz) 20(9800~11800MHz)				
RFDIP1608060L3T	2400~2500	50	0.8	18(4800~5000MHz) 20(7200~7500MHz)	10	-	1.60x0.80x0.60	A-2
	4900~5900	50	1.2	20(3700~3900MHz) 20(1800~2500MHz) 20(9800~11800MHz)				
RFDIP1608060L9T	2400~2500	50	0.6	20(4800~5000MHz) 20(7200~7500MHz)	10	-	1.60x0.80x0.60	B-1
	4900~5900	50	0.8	20(1800~2500MHz)				
RFDIP1608060LBT	2400~2500	50	0.6	20(4800~5000MHz) 20(7200~7500MHz)	10	28(30~2700 MHz) 26(4900~5950 MHz)	1.60x0.80x0.60	A-3
	4900~5900	50	1.4	28(30~2700MHz) 10(9800~11900MHz)				
RFDIP1608060LCT	2400~2500	50	0.6	20(4800~5000MHz) 20(7200~7500MHz)	10	28(30~2700 MHz) 26(4900~5950 MHz)	1.60x0.80x0.60	A-4
	4900~5900	50	1.4	28(30~2700MHz) 10(9800~11900MHz)				
RFDIP1608060LET	2400~2500	50	0.6	18(4800~5000MHz) 18(7200~7500MHz)	10	-	1.60x0.80x0.60	A-1
	4900~5900	50	1.4	20(3700~3900MHz) 20(1800~2500MHz) 10(9800~11800MHz))				
RFDIP1608060LFT	2400~2500	50	0.6	18(4800~5000MHz) 18(7200~7500MHz)	10	-	1.60x0.80x0.60	A-2
	4900~5900	50	1.4	20(3700~3900MHz) 20(1800~2500MHz) 10(9800~11800MHz)				
RFDIP160806BLM6T25	2400~2500	50	0.5	10(3600~3750MHz) 20(4800~5000MHz) 20(5000~5950MHz) 10(7200~7500MHz) 10(9600~10000MHz)	10	-	1.60x0.80x0.60	A-1
	4900~5950	50	0.6	25(860~960MHz) 25(1545~1605MHz) 25(1710~1990MHz) 30(2170 MHz) 10(8100~8800MHz) 15(8820~9800MHz) 25(9800~11900MHz)				

ISM Band 2.4/5GHz Application

Part Number	Frequency (MHz)	Impedance (Ω)	Insertion Loss (dB)	Attenuation (dB)	Return Loss (dB) Min	Isolation	Size (mm)	Structure
RFDIP160806ALM6T30	2400~2500	50	0.5	10(3600~3750MHz) 20(4800~5000MHz) 20(5000~5950MHz) 10(7200~7500MHz) 10(9600~10000MHz)	10	-	1.60x0.80x0.60	A-2
	4900~5950	50	0.6	25(860~960MHz) 25(1545~1605MHz) 25(1710~1990MHz) 30(2170MHz) 10(8100~8800MHz) 15(8820~9800MHz) 25(9800~11900MHz)		25(4800~5000 MHz)		
RFDIP160806LM0T60	2400~2500	50	0.75(25°C) 0.95(-40~+85°C)	20(4800~5000MHz) 20(7200~7500MHz)	10	-	1.60x0.80x0.60	A-2
	4900~5950	50	1.0(25°C) 1.3(-40~+85°C)	20(1800~2500MHz) 20(9800~11800MHz)				
RFDIP160806BLM6T68	2400~2500	50	0.50(25°C) 0.65(-40~+85°C)	21(4800~5000MHz) 21(5000~5950MHz) 25(7200~7500MHz)	10	32(2400~2500MHz) 25(4900~6000MHz)	10	A-2
	4900~5950	50	0.60(25°C) 0.75(-40~+85°C)	27(824~2170MHz) 30(2400~2500MHz) 20(9800~11900MHz)				
RFDIP1608060LVT	2400~2500	50	0.6	-	10	32 (30~2700 MHz) 28(4900~5950 MHz)	1.60x0.80x0.60	A-4
	4900~5950	50	0.8	32(30~2700MHz) 15(9800~11900MHz) 11(14700~17850MHz)				
RFDIP1608060LST	2400~2500	50	0.5(25°C) 0.6(-40~+85°C)	22(4800~5000MHz) 24(7200~7500MHz)	10	-	1.60x0.80x0.60	G
	5100~5900	50	1.1(25°C) 1.3(-40~+85°C)	25(1800~2500MHz) 24(3700~3900MHz) 22(9800~11900MHz)				
RFDIP1608060LY8Q1C	2400~2496	50	0.5	35(4800~5000MHz) 15(7200~7500MHz)	12	-	1.60x0.80x0.60	A-3
	5150~5950	50	1.0	30(70~2000MHz) 30(2400~2690MHz) 12(7250~7800MHz) 25(10300~12000MHz) 10(15000~18000MHz)				
RFDIP1606L168M1U	2400~2500	50	0.55(25°C) 0.60(-40~+85°C)	29(4800~5000MHz) 24(7200~7500MHz)	10	32(30~2700MHz) 28(4900~5950 MHz)	1.60x0.80x0.60	A-3
	4900~5950	50	0.70(25°C) 0.80(-40~+85°C)	32(30~2700MHz) 15(9800~11900MHz) 11(14700~17850MHz)				
RFDIP1606L21T	2400~2500	50	0.40(25°C) 0.50(-40~+85°C)	20(4900~5850MHz) 15(5850~8500MHz)	10	-	1.60x0.80x0.60	B-2
	4900~5850	50	0.60(25°C) 0.70(-40~+85°C)	20(2400~2500MHz)				
RFDIP1606L22T	2400~2500	50	0.40(25°C) 0.50(-40~+85°C)	20(4900~5850MHz)	10	-	1.60x0.80x0.60	B-1
	4900~5850	50	0.60(25°C) 0.70(-40~+85°C)	20(2400~2500MHz)				
RFDIP1606L23T	2400~2500	50	0.6	23(4800~5000MHz) 30(7200~7500MHz)	10	-	1.60x0.80x0.60	A-3
	5150~5850	50	1.5	25(2400~2500MHz) 15(3400~3600MHz) 10(3600~3900MHz) 20(6900~7550MHz) 30(10600~11700MHz) 20(15300~16200MHz)				
RFDIP1606L24T	2400~2500	50	0.5	23(4800~5000MHz) 30(7200~7500MHz)	10	-	1.60x0.80x0.60	A-4
	5150~5850	50	0.6	25(2400~2500MHz) 15(3400~3600MHz) 10(3600~3900MHz) 20(6900~7550MHz) 30(10600~11700MHz) 20(15300~16200MHz)				
RFDIP1606L29T	2400~2500	50	0.75(25°C) 0.95(-40~+85°C)	25(4800~5000MHz) 20(7200~7500MHz)	10	-	1.60x0.80x0.60	A-2
	4900~5950	50	1.10(25°C) 1.30(-40~+85°C)	20(1800~2500MHz) 15(9800~11900MHz)				

ISM Band 2.4/5GHz Application

Part Number	Frequency (MHz)	Impedance (Ω)	Insertion Loss (dB)	Attenuation (dB)	Return Loss (dB)Min	Isolation	Size (mm)	Structure
RFDIP1606L42T	2400~2500	50	0.6	23(4800~5000MHz) 30(7200~7500MHz)	10	40(5150~5850MHz)	1.60x0.80x0.60	A-3
	5100~5850	50	1.5	25(2400~2500MHz) 15(3400~3600MHz) 10(3600~3900MHz) 20(6900~7550MHz) 30(10600~11700MHz) 20(15300~16200MHz)				
RFDIP1606L44T	2400~2500	50	0.6	23(4800~5000MHz) 30(7200~7500MHz)	10	40(5150~5850MHz)	1.60x0.80x0.60	A-4
	5100~5850	50	1.5	25(2400~2500MHz) 15(3400~3600MHz) 10(3600~3900MHz) 20(6900~7550MHz) 30(10600~11700MHz) 20(15300~16200MHz)				
RFDIP1606L51T	2400~2500	50	0.35(25°C) 0.45(-40~+85°C)	20(4800~5000MHz) 22(5000~5950MHz) 20(7200~7500MHz)	10	-	1.60x0.80x0.60	B-2
	4900~5850	50	0.50(25°C) 0.60(-40~+85°C)	26(824~2170MHz) 30(2400~2500MHz) 25(9500~11900MHz)				
RFDIP1606L52T	2400~2500	50	0.40(25°C) 0.45(-40~+85°C)	21(4800~5000MHz) 23(5000~5500MHz) 28(5500~5950MHz) 21(7200~7500MHz)	10	-	1.60x0.80x0.60	B-1
	4900~5850	50	0.50(25°C) 0.60(-40~+85°C)	27(824~2170MHz) 31(2400~2500MHz) 26(9800~11900MHz)				
RFDIP1606L53T	2400~2500	50	0.5	10(3600~3750MHz) 20(4800~5000MHz) 20(5000~5950MHz) 10(7200~7500MHz) 10(9600~10000MHz)	10	-	1.60x0.80x0.60	A-3
	5150~5850	50	0.6	25(860~960MHz) 25(1545~1605MHz) 25(1710~1990MHz) 30(2170MHz) 25(2400~2500MHz) 10(8100~8800MHz) 15(8820~9800MHz) 25(9800~11900MHz)				
RFDIP1606L54T	2400~2500	50	0.5	10(3600~3750MHz) 20(4800~5000MHz) 20(5000~5950MHz) 10(7200~7500MHz) 10(9600~10000MHz)	10	-	1.60x0.80x0.60	A-4
	4900~5950	50	0.6	25(860~960MHz) 25(1545~1605MHz) 25(1710~1990MHz) 30(2170MHz) 25(2400~2500MHz) 10(8100~8800MHz) 15(8820~9800MHz) 25(9800~11900MHz)				
KFDIP2004L157B1U	2400~2500	50	0.5	10(3600MHz) 20(4800~5000MHz) 20(7200~7500MHz)	10	20(DC~2500MHz) 20(4900~5950MHz)	2.00x1.25x0.40	A-3
	4900~5950	50	1.0	20(824~915MHz) 20(1800~2500MHz) 10(3000~3900MHz) 4(7250MHz) 20(9800~11900MHz) 20(14700~17850MHz)				
KFDIP2004L167B1U	2400~2500	50	0.5	10(3600MHz) 20(4800~5000MHz) 20(7200~7500MHz)	10	20(DC~2500MHz) 20(4900~5950MHz)	2.00x1.25x0.40	A-4
	4900~5950	50	1.0	20(824~915MHz) 20(1800~2500MHz) 10(3000~3900MHz) 4(7250MHz) 20(9800~11900MHz) 20(14700~17850MHz)				

ISM Band 2.4/5GHz Application

Part Number	Frequency (MHz)	Impedance (Ω)	Insertion Loss (dB)	Attenuation (dB)	Return Loss (dB) Min	Isolation	Size (mm)	Structure
KFDIP2004L197B1U	2400~2500	50	0.6	15(3600MHz) 25(4800~5000MHz) 20(7200~7500MHz)	10	20(DC~2500MHz) 20(4900~5950MHz)	2.00x1.25x0.40	A-3
	4900~5950	50	1.0	20(824~915MHz) 18(1800~2500MHz) 14(3000~3900MHz) 20(9800~11900MHz) 20(14700~17850MHz)				
RFDIP2012050L5T	2400~2500	50	0.7	18(4800~6000MHz) 18(7200~7500 MHz)	10	-	2.00x1.25x0.55	A-1
	4900~5900	50	1.0	19(1800~2500MHz) 25(10300~10700MHz)				
RFDIP2012050L7T	2400~2500	50	0.7	18(4800~6000MHz) 18(7200~7500MHz)	10	-	2.00x1.25x0.55	A-2
	4900~5900	50	1.0	19(1800~2500MHz) 25(10300~10700MHz)				
RFDIP2012050L8T	2300~2500	50	0.65(25°C) 0.8(-40~+85°C)	20(4600~5000MHz) 20(6900~7500MHz)	10	-	2.00x1.25x0.55	A-3
	4900~5950	50	1.0	19(1800~2500MHz) 25(10300~10700MHz)				
RFDIP2012100L0T	2400~2500	50	0.7	20(4900MHz) 25(5200MHz) 25(5800MHz)	10	-	2.00x1.25x0.95	A-3
	4900~5900	50	0.9	25(2450MHz)				
RFDIP2012100L3T	2400~2500	50	0.7	20(4900MHz) 25(5200MHz) 25(5800MHz)	10	-	2.00x1.25x0.95	A-2
	4900~5900	50	0.9	25(2450MHz)				
RFDIP2012050LPT	2400~2500	50	0.5(25°C) 0.55(-40~+85°C)	23(4800~6000MHz) 20(7200~7500MHz)	10	-	2.00x1.25x0.55	A-1
	4900~5950	50	0.65(25°C) 0.75(-40~+85°C)	20(800~2500MHz) 15(9800~11900MHz)				
RFDIP2012050LQT	2400~2500	50	0.5(25°C) 0.55(-40~+85°C)	23(4800~6000MHz) 20(7200~7500MHz)	10	-	2.00x1.25x0.55	A-2
	4900~5950	50	0.65(25°C) 0.75(-40~+85°C)	20(800~2500MHz) 15(9800~11900MHz)				
RFDIP2012050LWT	2400~2500	50	0.50(25°C) 0.70(-40~+85°C)	20(4800~6000MHz) 20(7200~7500MHz)	10	-	2.00x1.25x0.55	A-4
	4900~5950	50	0.65(25°C) 0.85(-40~+85°C)	20(800~2500MHz) 15(9800~11900MHz)				
RFDIP2008L107N3T	2400~2500	50	2.2(25°C) 2.4(-40~+85°C)	30(824~915MHz) 30(1545~1610MHz) 30(1710~1990MHz) 25(2110~2170MHz) 8(3200~3600MHz) 12(3700~3900MHz) 28(4800~5000MHz) 25(7200~7500MHz)	10	-	2.00x1.25x0.80	A-1
	5150~5850	50	1.2(25°C) 1.5(-40~+85°C)	20(1545~1610MHz) 20(1710~1990MHz) 20(2110~2170MHz) 23(2400~2500MHz) 8(3450~3900MHz) 8(7250~7800MHz) 20(9800~11700MHz)				
RFDIP2008L117N3T	2400~2500	50	2.2(25°C) 2.4(-40~+85°C)	30(824~915MHz) 30(1545~1610MHz) 30(1710~1990MHz) 25(2110~2170MHz) 8(3200~3600MHz) 12(3700~3900MHz) 28(4800~5000MHz) 25(7200~7500MHz)	10	-	2.00x1.25x0.80	A-2
	5150~5850	50	1.2(25°C) 1.5(-40~+85°C)	20(1545~1610MHz) 20(1710~1990MHz) 20(2110~2170MHz) 23(2400~2500MHz) 8(3450~3900MHz) 8(7250~7800MHz) 20(9800~11700MHz)				

ISM Band 2.4/5GHz Application

Part Number	Frequency (MHz)	Impedance (Ω)	Insertion Loss (dB)	Attenuation (dB)	Return Loss (dB)Min	Isolation	Size(mm)	Structure
AMDIP2520070L3T	2400~2500	50	2.4(25°C) 2.7(-40~+85°C)	30(824~915MHz) 30(1545~1610MHz) 24(1710~1990MHz) 15(2110~2170MHz) 30(4800~5000MHz) 20(7200~7500MHz)	10	-	2.50x2.00x0.70	E-1
	5150~5850	50	1.2(25°C) 1.5(-40~+85°C)	25(1545~1610MHz) 25(2400~2500MHz) 15(10300~11700MHz)				
AMDIP2520070L4T	2400~2500	50	2.4(25°C) 2.7(-40~+85°C)	30(824~915MHz) 30(1545~1610MHz) 24(1710~1990MHz) 15(2110~2170MHz) 30(4800~5000MHz) 20(7200~7500MHz)	10	-	2.00x1.25x0.80	E-2
	5150~5850	50	1.2(25°C) 1.5(-40~+85°C)	25(1545~1610MHz) 25(2400~2500MHz) 15(10300~11700MHz)				

GPS 1.575GHz/ISM 2.4GHz/5GHz Band Application

Part Number	Frequency (MHz)	Impedance (Ω)	Insertion Loss (dB)	Attenuation (dB)	Return Loss (dB)Min.	Size (mm)	Structure
RFDIP1608060T1T	1574~1577	50	0.65	20(2400~2500MHz)	10	1.60x0.80x0.60	B-1
	2400~2500	50	0.8	20(1574~1577MHz)			
RFDIP1608060TM7T62	1570~1610	50	0.6(typ.0.5)	20(2400~2500MHz) 20(4900~5900MHz)	10	1.60x0.80x0.60	A-4
	2400~2500 4900~5900	50	0.65(typ.0.55)	20(1570~1610MHz)			
RFDIP1608070TM1T76	1710~1880	50	0.70(typ.0.59)	15(2500~2390MHz)	10	1.60x0.80x0.70	D-2
	2500~2690	50	0.65(typ.0.58)	15(1710~1880MHz)			
RFDIP1608060T8T	1570~1610	50	0.45(25°C) 0.55(-40~+85°C)	20(2400~2500MHz)	10	1.60x0.80x0.60	A-4
	2400~2500	50	0.5(25°C) 0.6(-40~+85°C)	20(1560~1607MHz)			
RFDIP1608060T9T	1570~1610	50	0.45(25°C) 0.55(-40~+85°C)	20(2400~2500MHz)	10	1.60x0.80x0.60	A-3
	2400~2500	50	0.5(25°C) 0.6(-40~+85°C)	20(1560~1607MHz)			
RFDIP1608060TAT	698~960 1427~1511 1560~1607	50	0.40 0.55 0.65	20(2400~2500MHz) 20(2620~2690MHz) 20(5150~5850MHz)	10	1.60x0.80x0.60	B-1
	2400~2500 2620~2690 5150~5850	50	0.70 0.60 0.80	20(698~960MHz) 20(1427~1511MHz) 20(1560~1607MHz)			
RFDIP1608060TCT	1570~1610	50	0.6(typ.0.5)	20(2400~2500MHz) 20(4900~5900MHz)	10	1.60x0.80x0.60	A-4
	2400~2500 4900~5900	50	0.65(typ.0.55)	20(1570~1610MHz)			
RFDIP1608060TDT	1570~1610	50	0.65(25°C) 0.75(-40~+85°C)	13(2170MHz) 20(2400~2500MHz)	10	1.60x0.80x0.60	B-2
	2400~2500	50	0.80(25°C) 0.90(-40~+85°C)	20(1565~1616MHz) 15(1710MHz)			
RFDIP2012090T2T	1572.5~1578.5 1597~1607	50	0.40 0.50	13(2400~2500MHz)	10	2.00x1.25x0.90	A-3
	2400~2500	50	0.55(25°C) 0.65(-40~+85°C)	22(1572.5~1578.5MHz) 20(1597~1607MHz)			
RFDIP2520080T1T	1710~1990 1990~2110 2110~2170	50	1.00 1.50 2.50	5(2300~2350MHz) 10(2350~2500MHz) 10(2500~2690MHz)	10	2.50x2.00x0.80	C-2
	2300~2350 2350~2500 2500~2690	50	2.65 1.50 0.65	8(1710~1990MHz) 8(1990~2110MHz) 5(2110~2170MHz)			

892 MHz & 1.94GHz Band Working Frequency

Part Number	Frequency (MHz)	Impedance (Ω)	Insertion Loss (dB)	Attenuation (dB)	Return Loss (dB)Min.	Size (mm)	Structure
RFDIP1608070GM1T76	698~960	50	0.8(typ.0.45)	25(1710~2700MHz)	10	1.60x0.80x0.60	D-2
	1710~2700		0.7(typ.0.50)	20(698~960MHz) 20(5150~5850MHz)			
RFDIP2012090G0T	824~960	50	0.6(25°C) 0.65(-40~+85°C)	15(1710~2170MHz)	10	2.00x1.25x0.90	A-3
	1710~2170		0.6(25°C) 0.65(-40~+85°C)	20(824~960MHz)			
RFDIP2012090G3T	824~960	50	0.6(25°C) 0.65(-40~+85°C)	15(1710~2170MHz)	10	2.00x1.25x0.90	A-4
	1710~2170		0.6(25°C) 0.65(-40~+85°C)	20(824~960MHz)			
RFDIP2012070G5T	570~960	50	0.75	20(1427~2700MHz)	10	2.00x1.25x0.70	C-1
	1427~2700		0.85	20(570~960MHz)			
RFDIP2012090G77N2T	698~960	50	0.65	15(1554~1580MHz) 20(1710~2700MHz)	10	2.00x1.25x0.90	A-4
	1710~2700		0.65	20(824~960MHz)			
RFDIP2012090GM1T58	698~960	50	0.4(25°C) 0.45(-40~+85°C)	13(1710~2690MHz)	10	2.00x1.25x0.90	C-1
	1710~2690		0.55(25°C) 0.65(-40~+85°C)	19(698~960MHz)			
RFDIP2520100G2T	698~960	50	0.35(25°C) 0.45(-40~+85°C)	20(1710~2690MHz)	10	2.50x2.00x1.00	F
	1710~2690		0.55(25°C) 0.65(-40~+85°C)	25(698~960MHz) 5(3420~3820MHz)			

■ TYPICAL ELECTRICAL CHARACTERISTICS

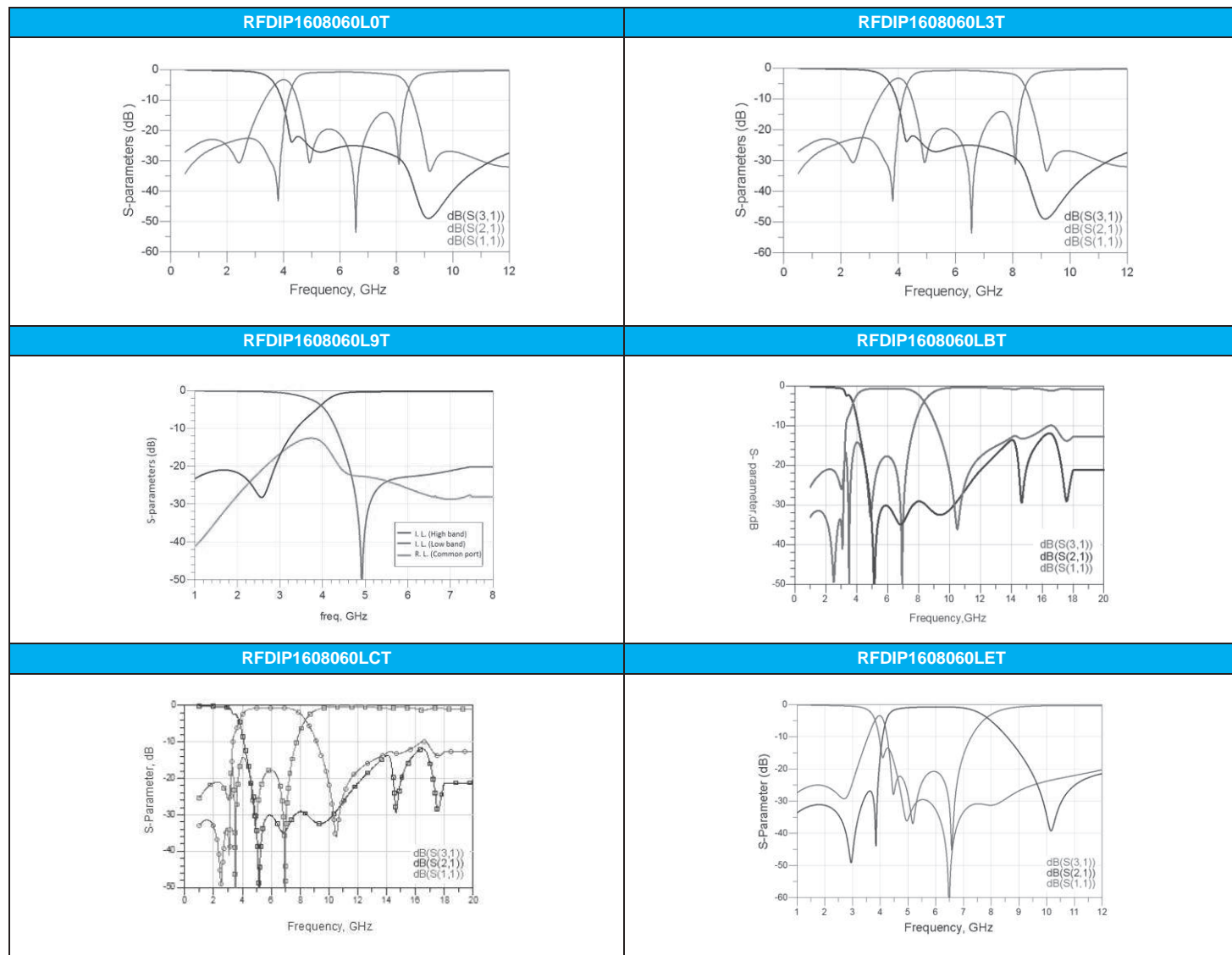

TYPICAL ELECTRICAL CHARACTERISTICS

RFDIP1608060LFT

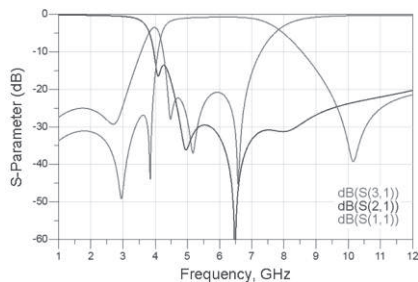

RFDIP160806BLM6T25

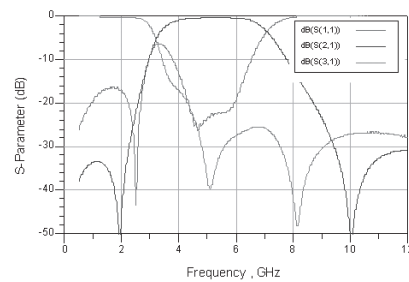

RFDIP160806ALM6T30

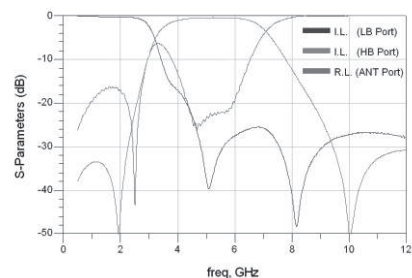

RFDIP160806LM0T60

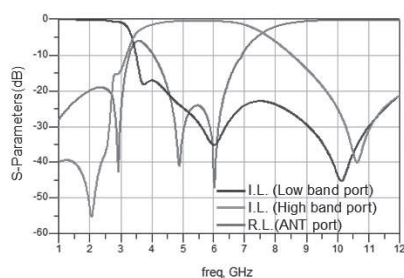

RFDIP160806BLM6T68

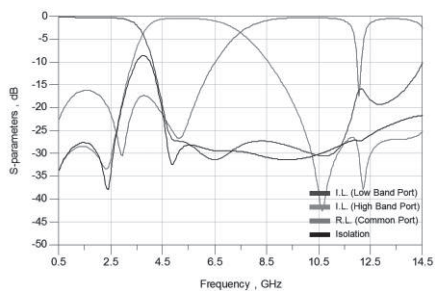

RFDIP1608060LVT

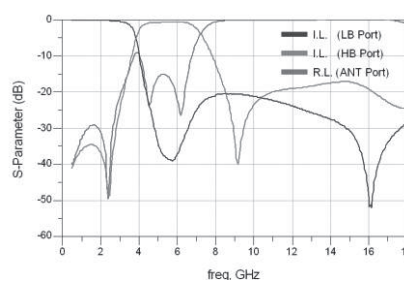

RFDIP1608060LST

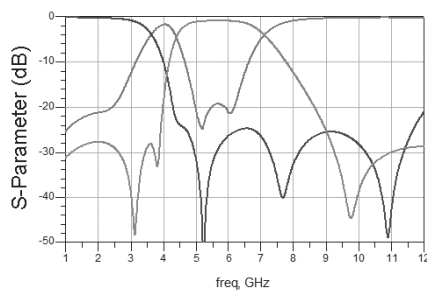

RFDIP1608060LY8Q1C

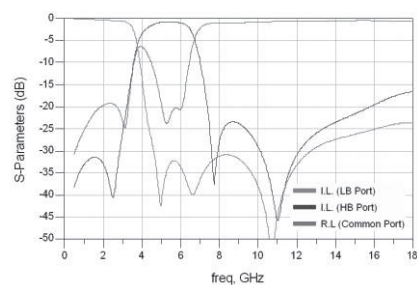

RFDIP1606L168M1U

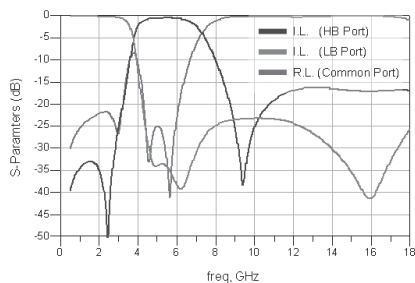

RFDIP1606L21T

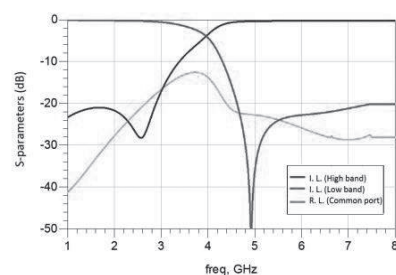

TYPICAL ELECTRICAL CHARACTERISTICS

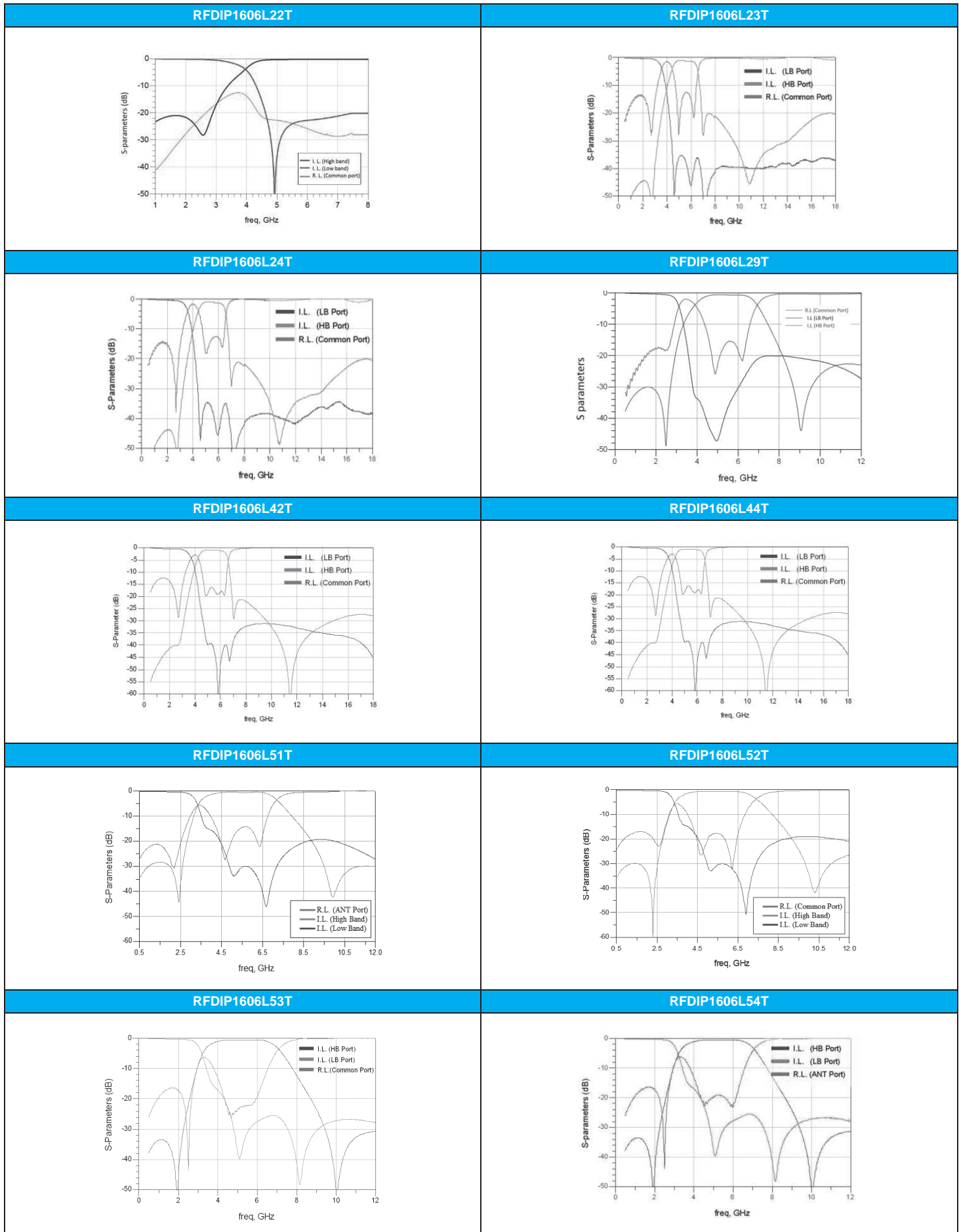

TYPICAL ELECTRICAL CHARACTERISTICS

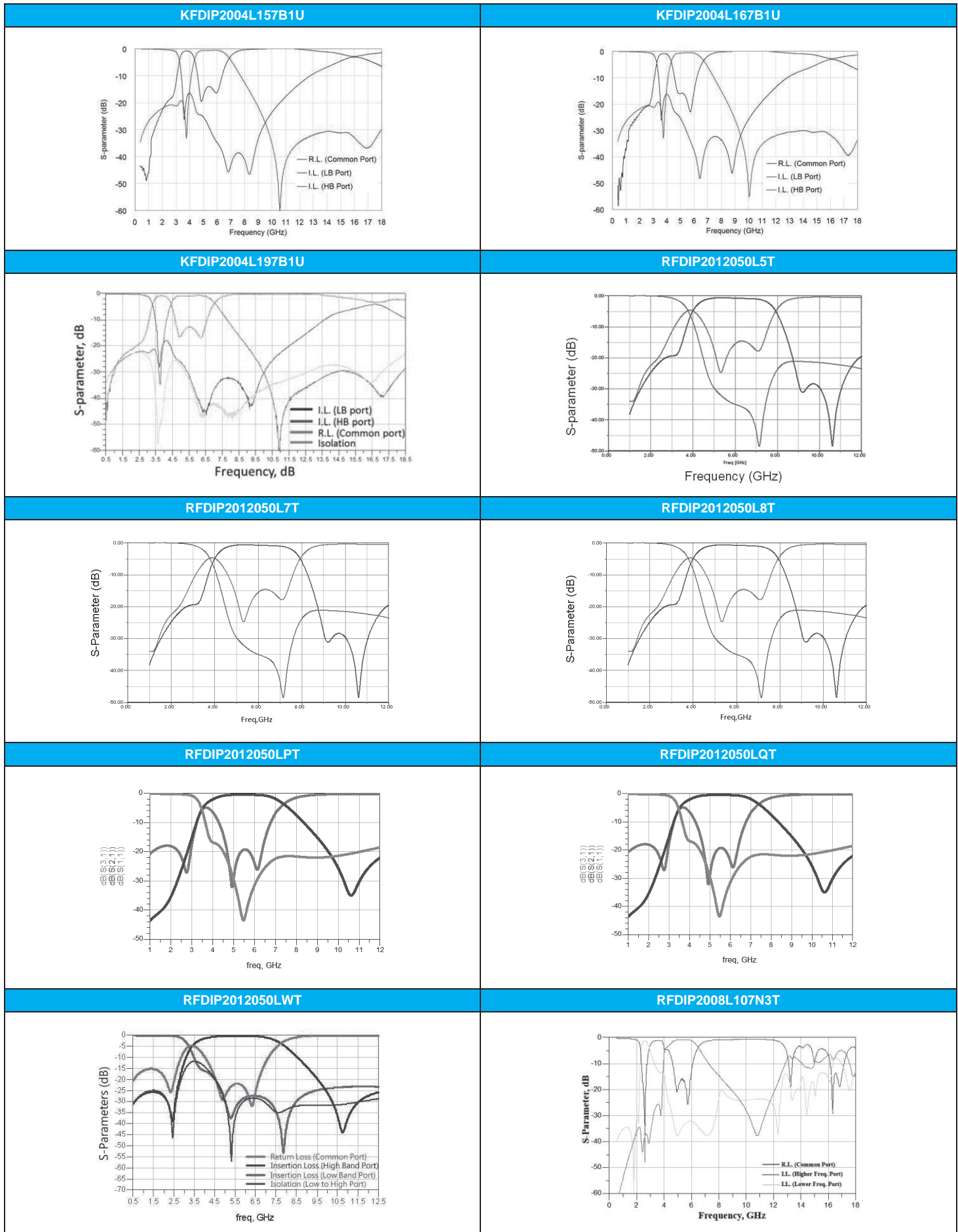

TYPICAL ELECTRICAL CHARACTERISTICS

RFDIP2008L117N3T

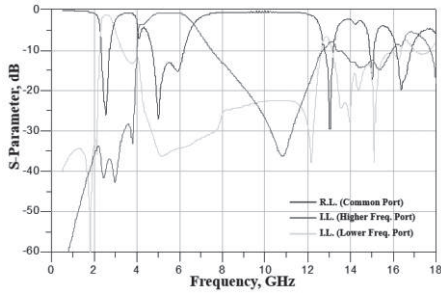

AMDIP2520070L3T

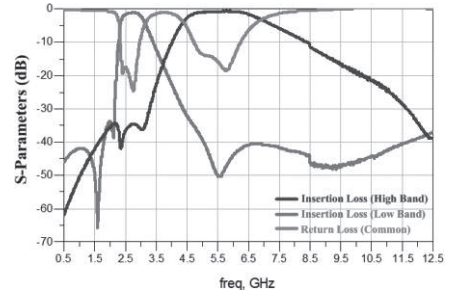

AMDIP2520070L4T

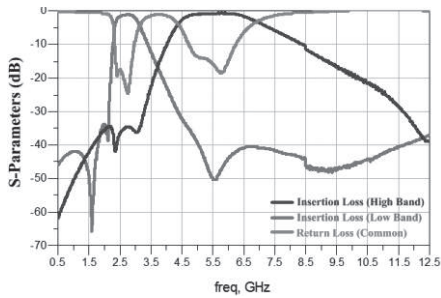

RFDIP1608060T1T

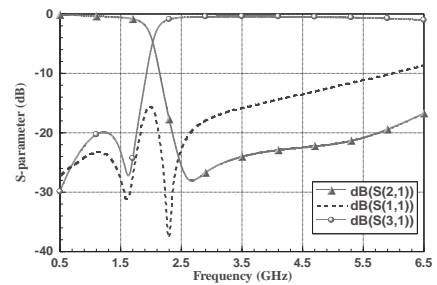

RFDIP1608060TM7T62

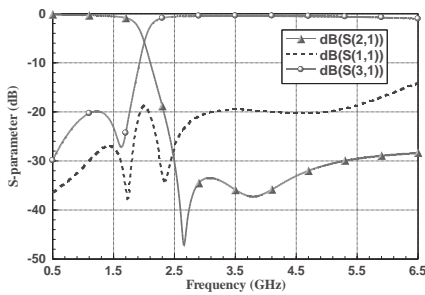

RFDIP1608070TM1T76

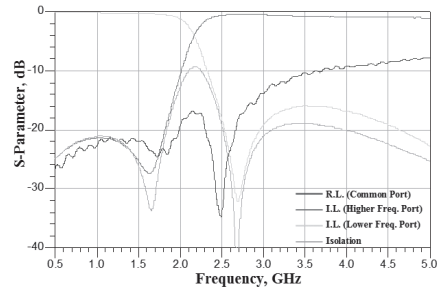

RFDIP1608060T8T

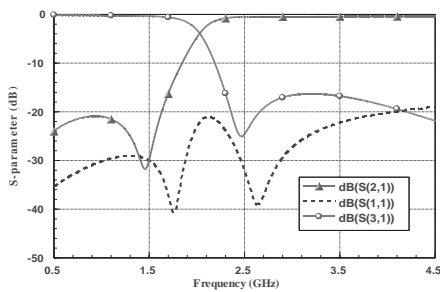

RFDIP1608060T9T

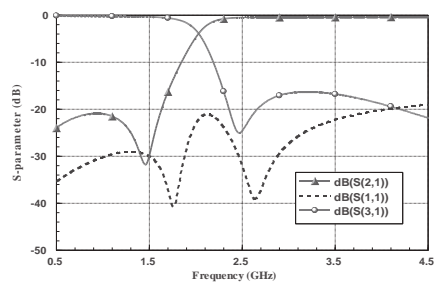

RFDIP1608060TAT

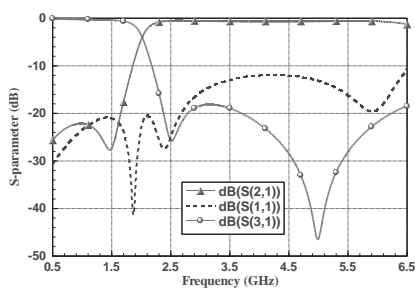

RFDIP1608060TCT

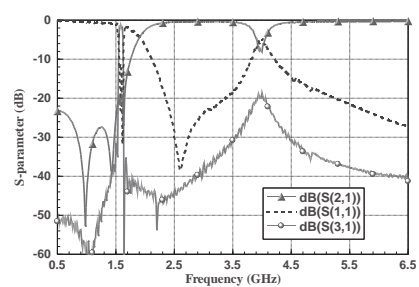

TYPICAL ELECTRICAL CHARACTERISTICS

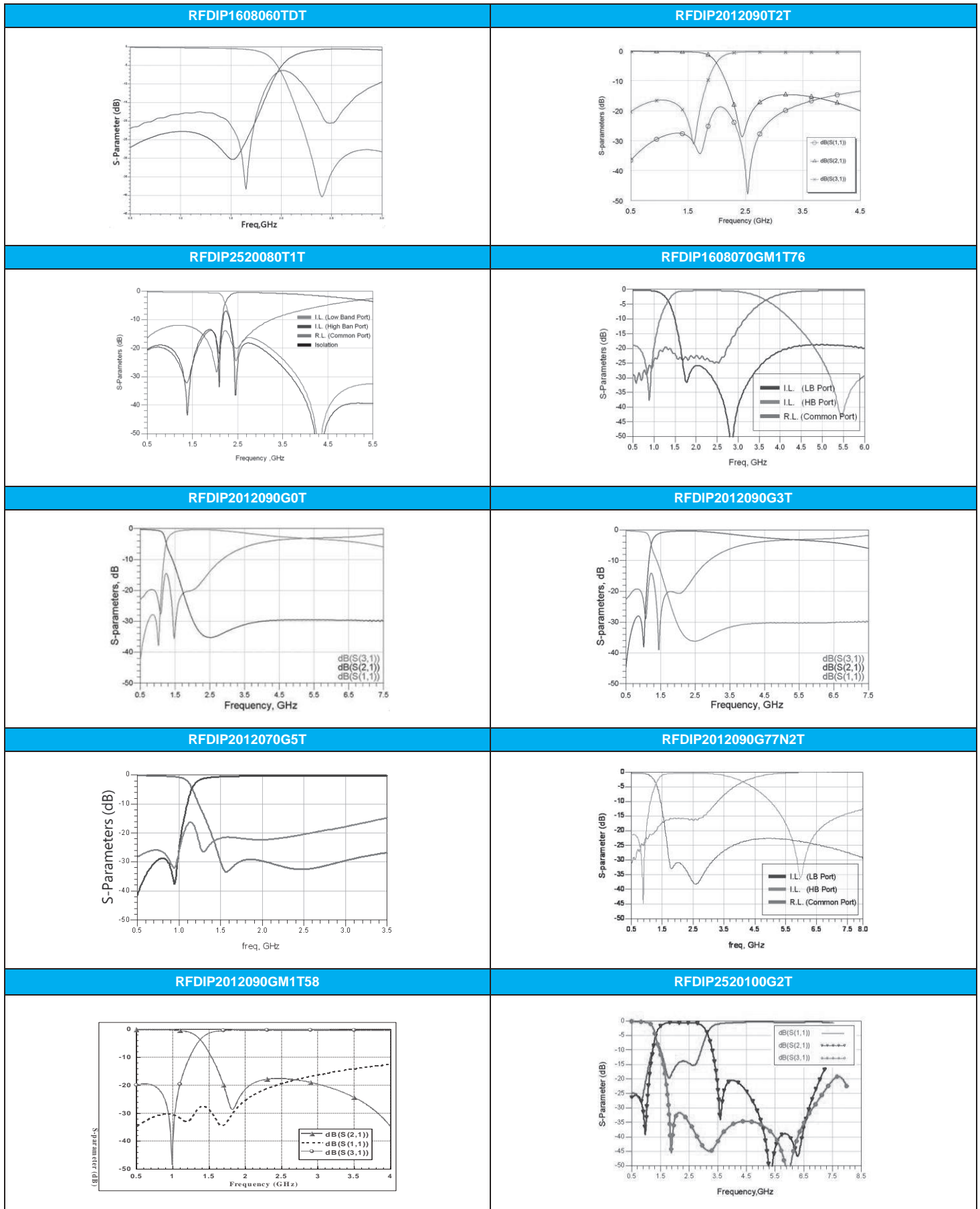

- For more information, please contact with local sales representative
- All specifications are subject to change without notice

TRIPLEXER

■ **STRUCTURE AND PIN ASSOCIATED**

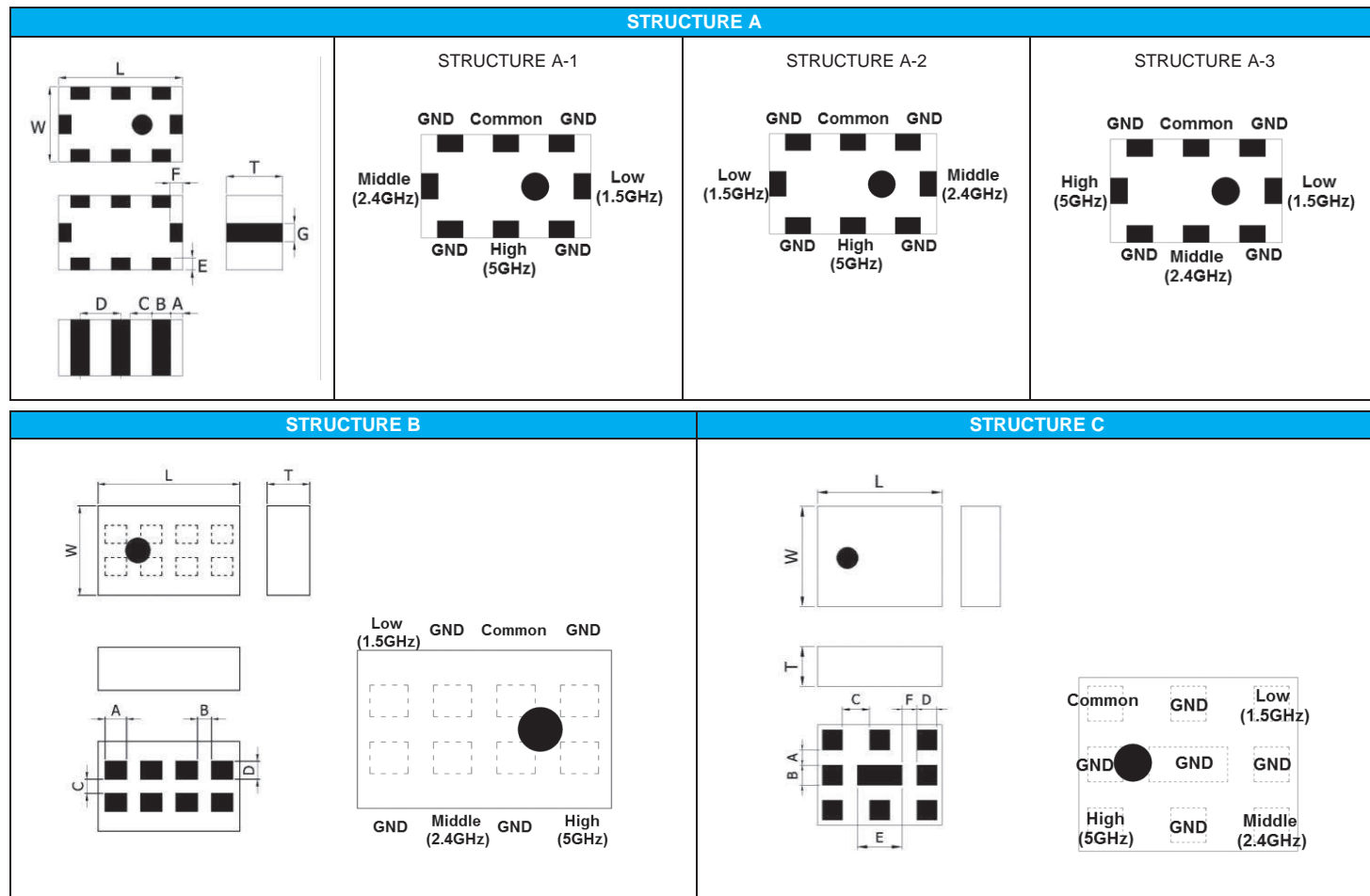

■ **STRUCTURE AND DIMENSION**

Unit: mm

Structure\ Dimension	L	W	T	A	B	C	D	E	F	G
A	2.00±0.15	1.25±0.15	0.90±0.10	0.20±0.20	0.30±0.20	0.35±0.20	0.65±0.20	0.20±0.20	0.20±0.20	0.30±0.20
B	2.00±0.15	1.25±0.15	0.75 max.	0.30±0.10	0.20±0.10	0.20±0.10	0.25±0.10	-	-	-
C	2.50±0.15	2.00±0.15	0.90±0.10	0.30±0.10	0.40±0.10	0.55±0.10	0.40±0.10	0.90±0.10	0.30±0.10	0.30±0.10

■ **ELECTRICAL SPECIFICATION**

GPS 1.575GHz/ISM 2.4GHz/5GHz band RF application

Part Number	Frequency (MHz)	Impedance (Ω)	Insertion Loss (dB)	Attenuation (dB)	Return Loss (dB) Min	Isolation	Size (mm)	Structure
RFTIP2012090T18Q1C	1560~1606	50	0.6	15(2400~2500 MHz) 15(4800~6000 MHz)	10	-	2.00x1.25x0.90	A-1
	2400~2500	50	0.7	10(860~960 MHz) 15(1545~1605 MHz) 10(3600~3750 MHz) 20(4800~6000 MHz) 10(7200~7500 MHz) 10(9600~10000 MHz)	10	20(1559~1606 MHz) 25(4800~5000 MHz)		
	4900~5950	50	0.8	25(860~960 MHz) 25(1545~1605 MHz) 25(1710~1990 MHz) 30(2170 MHz) 10(8100~8800 MHz) 15(8820~9800 MHz) 25(9800~11900 MHz)	10	20(1559~1606 MHz)		

■ ELECTRICAL SPECIFICATION

GPS 1.575GHz/ ISM 2.4GHz/5GHz band RF application

Part Number	Frequency (MHz)	Impedance (Ω)	Insertion Loss (dB)	Attenuation (dB)	Return Loss (dB) Min	Isolation	Size (mm)	Structure
RFTIP2012090T27N3T	1560~1606	50	0.65(25°C) 0.70(-40~+85°C)	20(2400~2500 MHz) 20(4900~6000 MHz)	10	-	2.00x1.25x0.90	A-2
	2400~2500	50	0.70(25°C) 0.85(-40~+85°C)	10(860~960 MHz) 15(1545~1610 MHz) 10(3600~3750 MHz) 20(4800~6000 MHz) 10(7200~7500 MHz) 10(9600~10000 MHz)	10	20(1559~1606 MHz) 20(4800~5000 MHz)		
	4900~5950	50	0.80(25°C) 0.95(-40~+85°C)	25(1559~1606 MHz) 35(2400~2500 MHz) 12(3400~3600 MHz) 12(3600~3900 MHz) 10(6900~7200 MHz) 10(7200~7800 MHz) 25(10300~11700 MHz) 15(15300~16200 MHz)	10	20(1559~1606 MHz)		
RFTIP2012090T9T	1560~1606	50	0.7	15(2400~2500 MHz) 15(4800~6000 MHz)	10	-	2.00x1.25x0.90	A-3
	2400~2500	50	0.8	10(860~960 MHz) 15(1545~1605 MHz) 8(3600~3750 MHz) 20(4800~5000 MHz) 10(7200~7500 MHz) 10(9600~10000 MHz)	10			
	4900~5950	50	0.9	25(860~960 MHz) 25(1545~1605 MHz) 25(1710~1990 MHz) 30(2170 MHz) 38(2400~2500 MHz) 8(8100~8800 MHz) 15(8820~9800 MHz) 22(9800~11900 MHz)	10			
RFTIP2012070TH8Q1C	1559~1606	50	0.6	15(2400~2500 MHz) 15(4900~5950 MHz)	10	10(2400~2500 MHz) 10(5150~5950 MHz)	2.00x1.25x0.75	B
	2400~2500	50	1.0	20(1559~1606 MHz) 35(4800~5000 MHz) 15(7200~7500 MHz)	10	25(1559~1606 MHz) 30(5150~5950 MHz)		
	4900~5150 5100~5950	50	1.4 1.2	25(1559~1606 MHz) 35(2400~2500 MHz) 12(3400~3600 MHz) 12(3600~3900 MHz) 10(6900~7200 MHz) 10(7200~7800 MHz) 25(10300~11700 MHz) 15(15300~16200 MHz)	10	25(1559~1606 MHz) 30(2400~2500 MHz)		
RFTIP2109ATM0T63	1560~1606	50	0.60(25°C) 0.80(-40~+85°C)	15(2400~2500 MHz) 15(4800~6000 MHz)	10	-	2.00x1.25x0.90	A-1
	2400~2500	50	0.70(25°C) 0.90(-40~+85°C)	10(860~960 MHz) 15(1545~1605 MHz) 10(3600~3750 MHz) 20(4800~5000 MHz) 10(7200~7500 MHz) 10(9600~10000 MHz)	10	20(1559~1606 MHz) 25(4800~5000 MHz)		
	4900~5950	50	0.80(25°C) 1.00(-40~+85°C)	25(860~960 MHz) 25(1545~1605 MHz) 25(1710~1990 MHz) 30(2170 MHz) 10(8100~8800 MHz) 15(8820~9800 MHz) 25(9800~11900 MHz)	10	25(1559~1606 MHz)		
RFTIP2109BTM5T62	1560~1606	50	0.60(25°C) 0.80(-40~+85°C)	15(2400~2500 MHz) 15(4800~6000 MHz)	10	-	2.00x1.25x0.90	A-2
	2400~2500	50	0.70(25°C) 0.90(-40~+85°C)	10(860~960 MHz) 15(1545~1605 MHz) 10(3600~3750 MHz) 20(4800~5000 MHz) 10(7200~7500 MHz) 10(9600~10000 MHz)	10	20(1559~1606 MHz) 25(4800~5000 MHz)		
	4900~5950	50	0.80(25°C) 1.00(-40~+85°C)	25(860~960 MHz) 25(1545~1605 MHz) 25(1710~1990 MHz) 30(2170 MHz) 10(8100~8800 MHz) 15(8820~9800 MHz) 25(9800~11900 MHz)	10	25(1559~1606 MHz)		

GPS 1.575GHz/ ISM 2.4GHz/5GHz band RF application

Part Number	Frequency (MHz)	Impedance (Ω)	Insertion Loss (dB)	Attenuation (dB)	Return Loss (dB) Min	Isolation	Size (mm)	Structure
RFTIP2520090T3T	698~960	50	0.70(25°C) 0.80(-40~+85°C)	20(1710~2200 MHz) 20(2500~2690 MHz)	10	20(1710~2200 MHz) 20(2500~2690 MHz)	2.50x2.00x0.90	C
	1710~2200	50	1.40(25°C) 1.60(-40~+85°C)	20(698~960 MHz) 15(2500~2690 MHz)	10	18(698~960 MHz) 18(2500~2690 MHz)		
	2500~2690	50	1.80(25°C) 2.00(-40~+85°C)	15(698~960 MHz) 15(1710~2200 MHz)	10	20(698~960 MHz) 20(1710~2200 MHz)		

■ TYPICAL ELECTRICAL CHARACTERISTICS

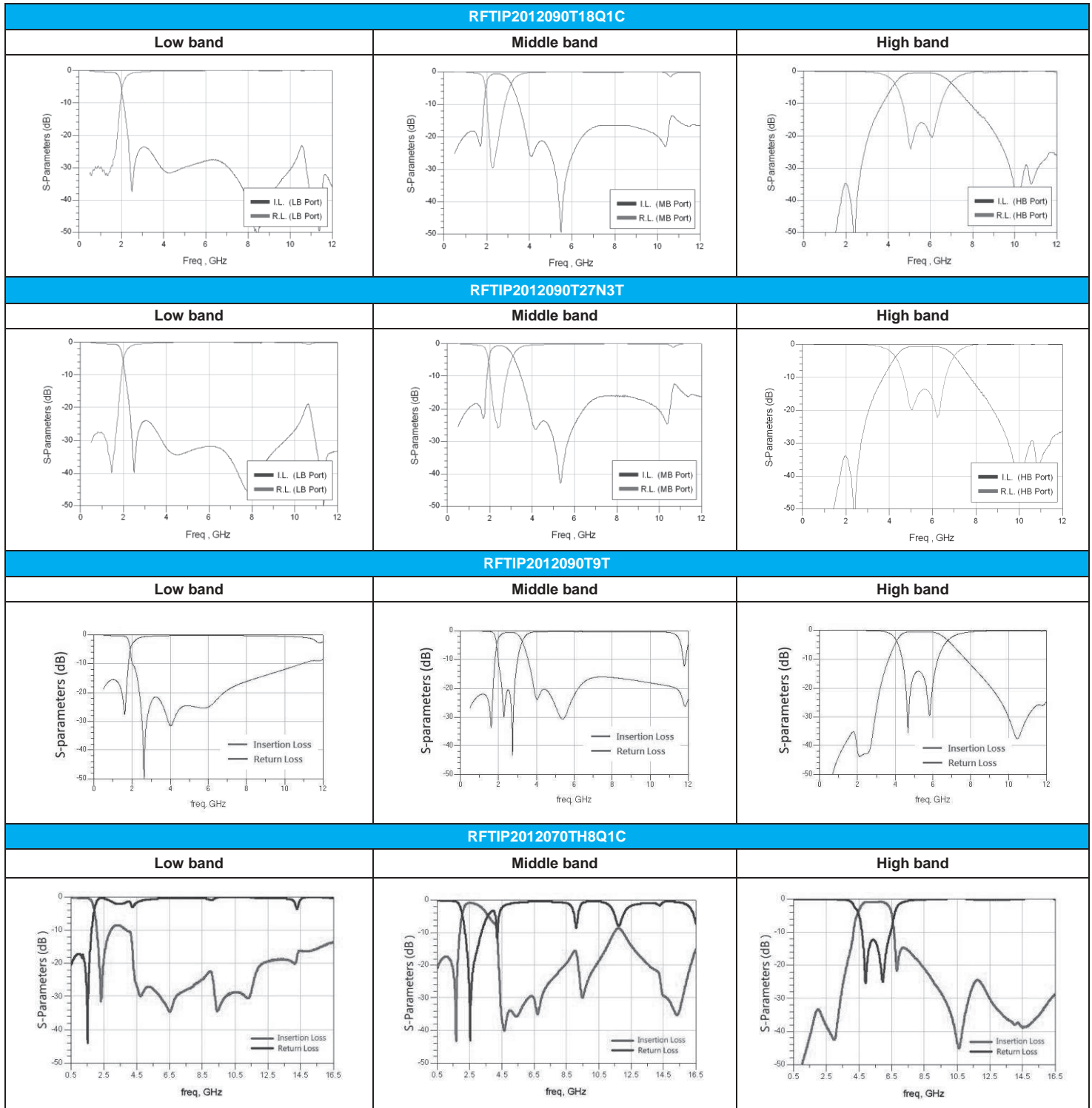

TYPICAL ELECTRICAL CHARACTERISTICS

RFTIP2109ATM0T63

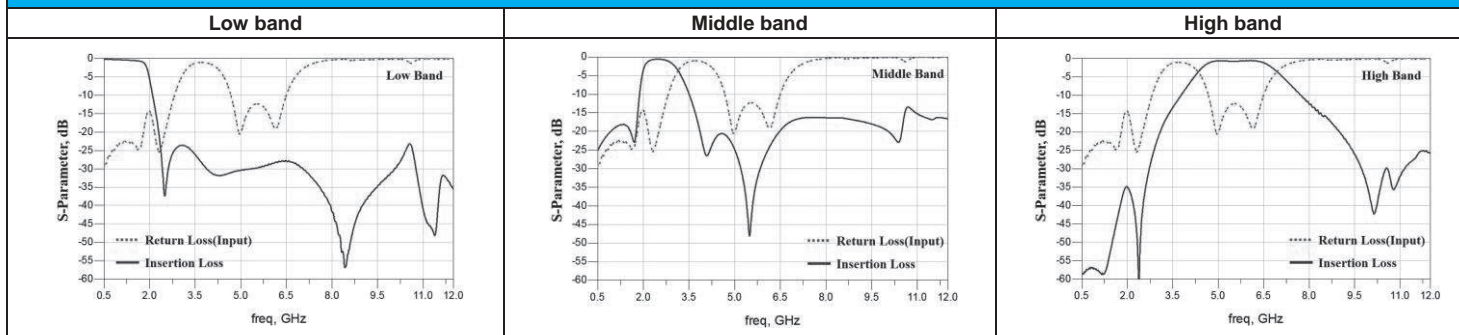

RFTIP2109BTM5T62

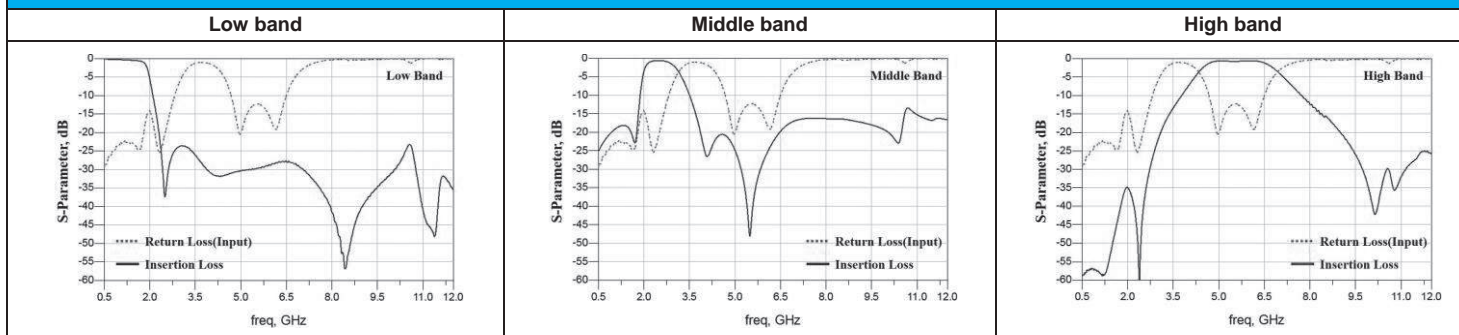

RFTIP2520090T3T

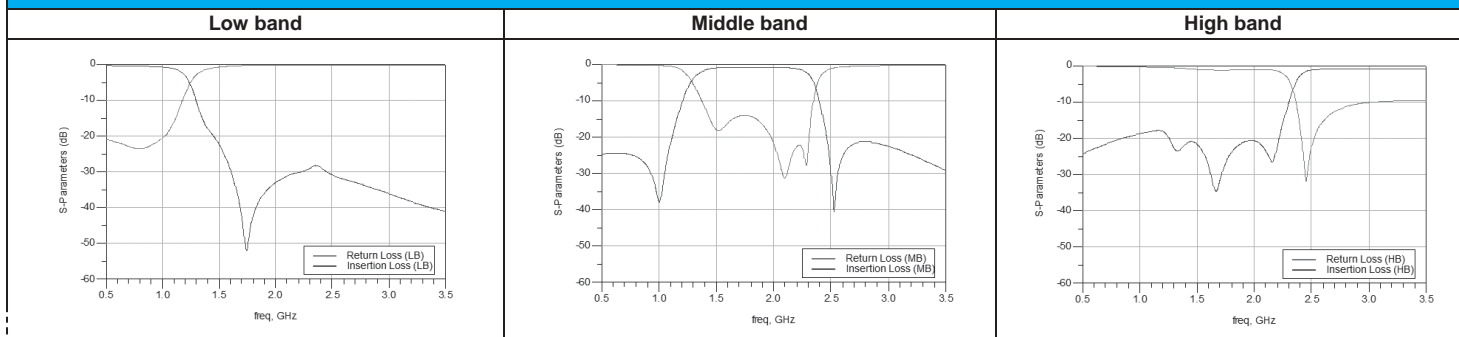

- For more information, please contact with local sales representative
- All specifications are subject to change without notice

COMMON MODE FILTER

■ **STRUCTURE AND PIN ASSOCIATED**

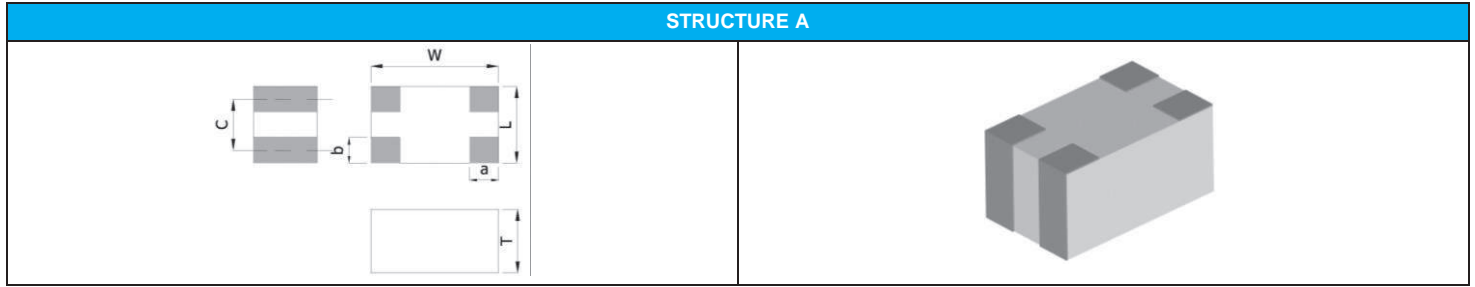

■ **STRUCTURE AND DIMENSION**

Unit: mm

Structure/ Dimension	L	W	T	a	b	c
A	1.20+0.40 -0.20	2.00+0.40 -0.20	1.00±0.20	0.45±0.20	0.40±0.20	0.80±0.10
	1.60±0.20	3.20±0.20	0.95±0.20	0.60±0.20	0.50±0.20	1.10±0.20
			1.00±0.20	0.60±0.20	0.50±0.20	1.10±0.20

■ **ELECTRICAL SPECIFICATION**

DISCRETE CMF for HIGH SPEED TRANSMISSION LINES · USB2.0 · IEEE1394 · LVDS(mini)

Part Number	Characteristic Impedance (Differential)	Common Mode Attenuation (Min.)	DC Resistance (Ω) max.	Rated Current (mA)	Size(mm)	Structure
RFCMF1220100M3T	90 ohm	9.0(240MHz ~ 1GHz)	1.5	300	1.20x2.00x1.00	A
RFCMF1220100M4T	90 ohm	9.0(130 MHz ~ 1GHz)	2.5	200	1.20x2.00x1.00	A
RFCMF1632090M1T	90 ohm	9.0(140 MHz ~ 1.0 GHz)	1.5	300	1.60x3.20x0.95	A
RFCMF1632100M3T	90 ohm	9.0(240 MHz ~ 1.0 GHz)	1.5	300	1.60x3.20x1.00	A

■ **TYPICAL ELECTRICAL CHARACTERISTICS**

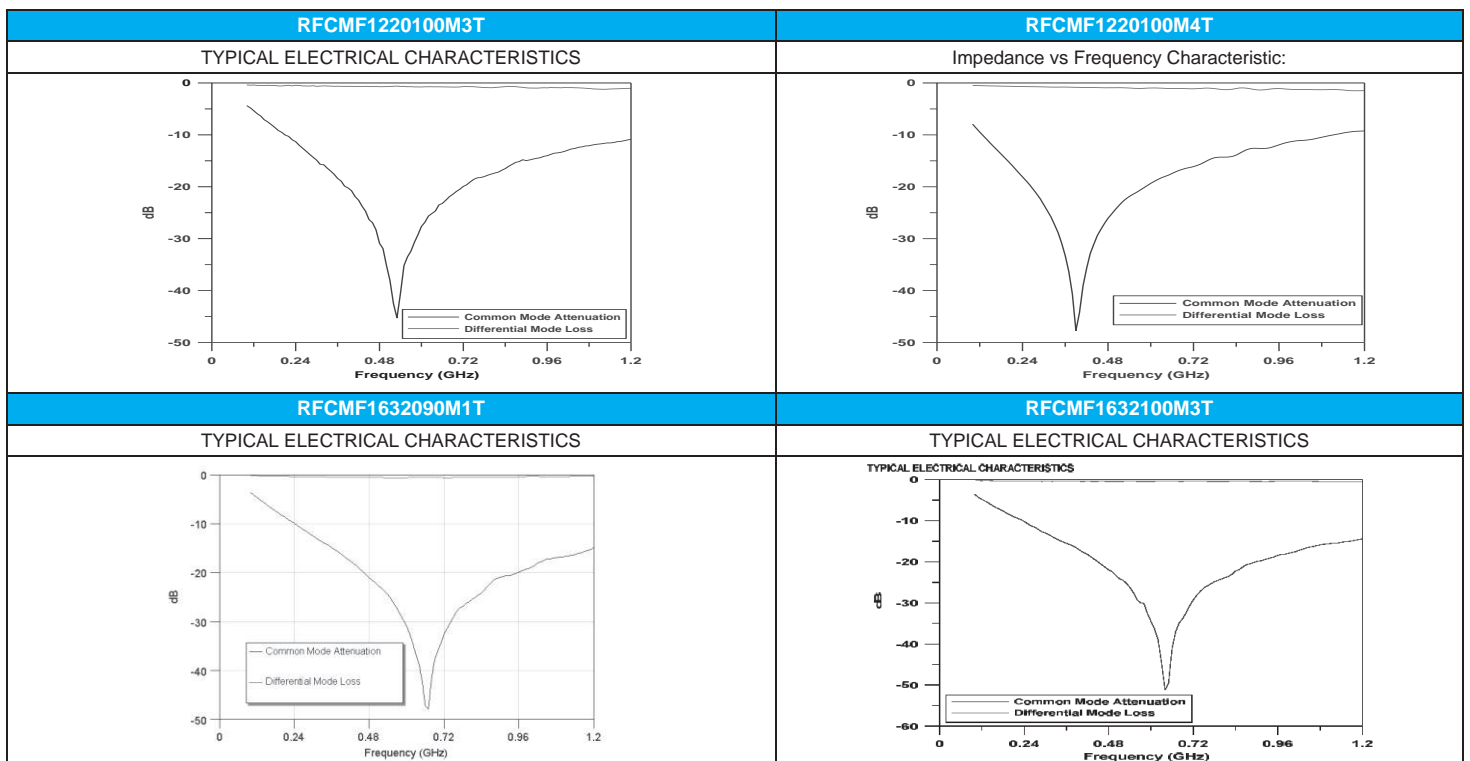

- For more information, please contact with local sales representative
- All specifications are subject to change without notice

COUPLER

■ **STRUCTURE AND PIN ASSOCIATED**

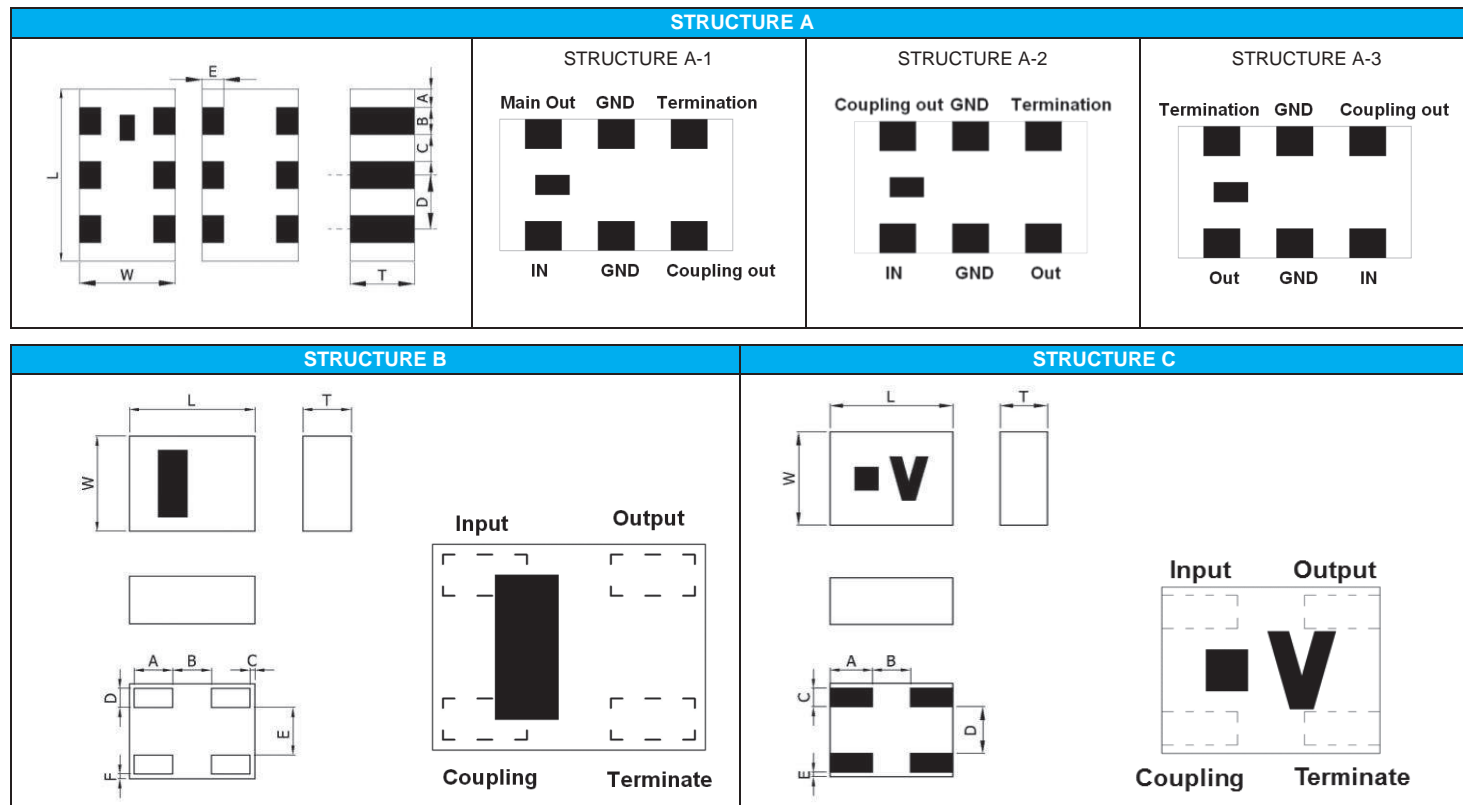

■ **STRUCTURE AND DIMENSION**

Unit: mm

Structure\ Dimension	L	W	T	A	B	C	D	E	F
A	1.60±0.10	0.80±0.10	0.60±0.10	0.10±0.10	0.30±0.10	0.25±0.10	0.55±0.10	0.20±0.10	-
	1.60±0.10	0.80±0.10	0.60±0.10	0.175±0.10	0.25±0.10	0.25±0.10	0.50±0.10	0.20±0.10	-
B	0.65±0.04	0.50±0.04	0.35±0.10	0.20±0.04	0.20±0.04	0.025±0.025	0.10±0.04	0.25±0.04	0.025±0.025
C	0.65±0.10	0.50±0.10	0.35±0.05	0.225±0.10	0.20±0.05	0.10±0.05	0.25±0.05	0.025±0.025	-

■ **ELECTRICAL SPECIFICATION**

ISM Band 2.4GHz Application

Part Number	Frequency (MHz)	Insertion Loss (dB)	Coupling in BW	Directivity in BW dB (min.)	Isolation in BW dB (min.)	VSWR	Dimension (mm³)	Structure
RFCPL1806B2450T	2400~2500	1.83	6.5 ± 1.0 dB	-	21.0 dB min	1.5	1.60x1.80x0.60	A-1
RFCPL1810B2450T	2400~2500	0.74	10.0 ± 1.0 dB	-	22.0 dB min	1.8	1.60x1.80x0.60	A-1
TFCPL0605B24508Q1C	2400~2500	0.32(25°C) 0.40(-40~+85°C)	14.6 ± 1.0 dB	20.0 dB min.	-	1.3	0.60x0.50x0.35	B

ISM Band 2.4/5GHz Application

Part Number	Frequency (MHz)	Insertion Loss (dB)	Coupling in BW	Directivity in BW dB (min.)	Isolation in BW dB (min.)	VSWR	Dimension (mm ³)	Structure
TFCPL0605030L18A1U	2400~2500	0.5	19.0±1.5dB	15 dB min.	-	1.3	0.65x0.50x0.35	B
	4900~5850	0.5	12.5±1.5dB	15 dB min.	-	1.3		
TFCPL0605030L28Q1C	2400~2500	0.2	19.3±0.7dB	15 dB min.	-	1.3	0.65x0.50x0.35	B
	5150~5850	0.5	13.0±1.5dB	15 dB min.	-	1.3		
RFCPL0605030L58Q1C	2400~2500	0.3	19.0±1.5dB	14.5 dB min.	-	1.3	0.65x0.50x0.35	C
	4900~5850	0.6	13.0±2.0dB	13.5dB min.	-	1.8		
RFCPL0605030L6T	2400~2500	0.40(25°C) 0.45(-40~+85°C)	21.5±1.5dB	15 dB min.	-	1.3	0.65x0.50x0.35	C
	4900~5850	0.40(25°C) 0.45(-40~+85°C)	15.0±1.5dB	15 dB min.	-	1.3		
RFCPL0605030L9T	2400~2500	0.20(25°C) 0.25(-40~+85°C)	19.3±0.7dB	15 dB min.	-	1.3	0.65x0.50x0.35	C
	4900~5850	0.50(25°C) 0.55(-40~+85°C)	13.0±1.5dB	15 dB min.	-	1.3		

LTE BAND APPLICATION

Part Number	Frequency (MHz)	Insertion Loss (dB)	Coupling in BW	Directivity in BW dB (min.)	Isolation in BW dB (min.)	VSWR	Dimension (mm ³)	Structure
RFCPL1608070P08Q1C	698~2690	0.20(698~960MHz) 0.22(1427.9~2170MHz) 0.25(2300~2690MHz)	23.0~27.0(698~915MHz) 21.5~26.5(1427.9~2025MHz) 22.5~27.5(2300~2620MHz)	20.	-	1.5	1.60x1.80x0.60	A-2
RFCPL1608070P18Q1C	698~2690	0.20(698~960MHz) (Typ.0.02) 0.22(1710~2170MHz) (Typ.0.07) 0.25(2300~2690MHz) (Typ.0.10)	23.0~27.0(698~915MHz) 21.5~26.5(1710~2025MHz) 22.5~27.5(2300~2620MHz)	20	-	1.45	1.60x1.80x0.60	A-3
RFCPL1608070P28Q1C	698~2690	0.20(698~960MHz) 0.22(1427.9~2170MHz) 0.25(2300~2690MHz)	23.0~27.0(698~915MHz) 21.5~26.5(1427.9~2025MHz) 22.5~27.5(2300~2620MHz)	20	-	1.5	1.60x1.80x0.60	A-2
RFCPL1608070P38Q1C	698~2690	0.20(698~960MHz) 0.22(1710~2170MHz) 0.25(2300~2690MHz)	23.0~27.0(698~915MHz) 21.5~26.5(1710~2025MHz) 22.5~27.5(2300~2620MHz)	20	-	1.45	1.60x1.80x0.60	A-3
RFCPL1608070PHT	699~2155	0.20(699~960MHz) 0.22(1710~2155MHz)	24.5~28.5(699~960MHz) 23.0~28.0(1710~1910MHz)	20	-	1.45	1.60x1.80x0.60	A-4
RFCPL1608070PKT	699~2155	0.20(699~960MHz) 0.22(1710~2155MHz)	24.5~28.5(699~960MHz) 23.0~28.0(1710~1910MHz)	20	-	1.45	1.60x1.80x0.60	A-3
RFCPL1608070PM9T16	700~2700	0.2(700~790MHz) (Typ.0.07) 0.2(820~900MHz) (Typ.0.07) 0.3(1701~2100MHz) (Typ.0.15) 0.3(2300~2700MHz) (Typ.0.15)	24~27(700~790MHz) 24~27(820~900MHz) 20~23(1701~2100MHz) 20~23(2300~2700MHz)	-	40(700~790MHz) 40(820~900MHz) 35(1701~2100MHz) 35(2300~2700MHz)	1.45	1.60x1.80x0.60	A-1

TYPICAL ELECTRICAL CHARACTERISTICS

RFCPL1806B2450T

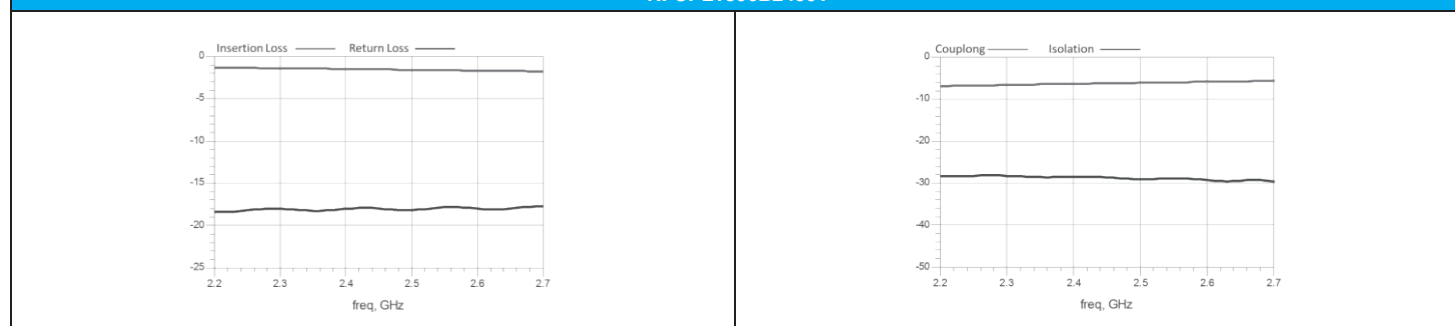

TYPICAL ELECTRICAL CHARACTERISTICS

RFCPL1810B2450T

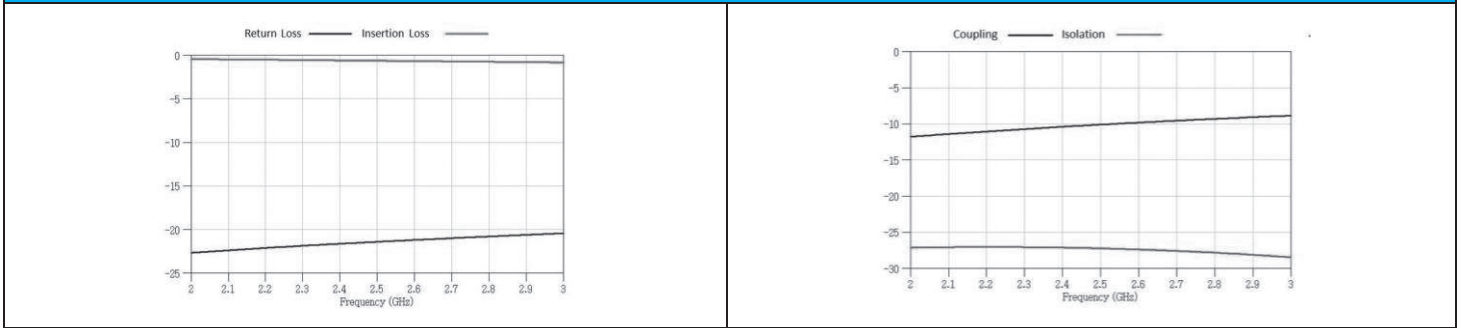

TFCPL0605B24508Q1C

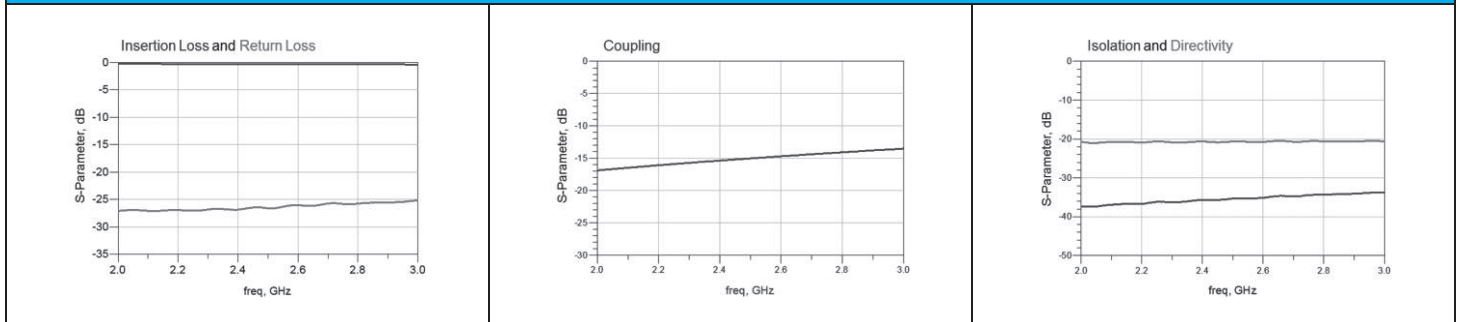

FCPL0605030L28Q1C

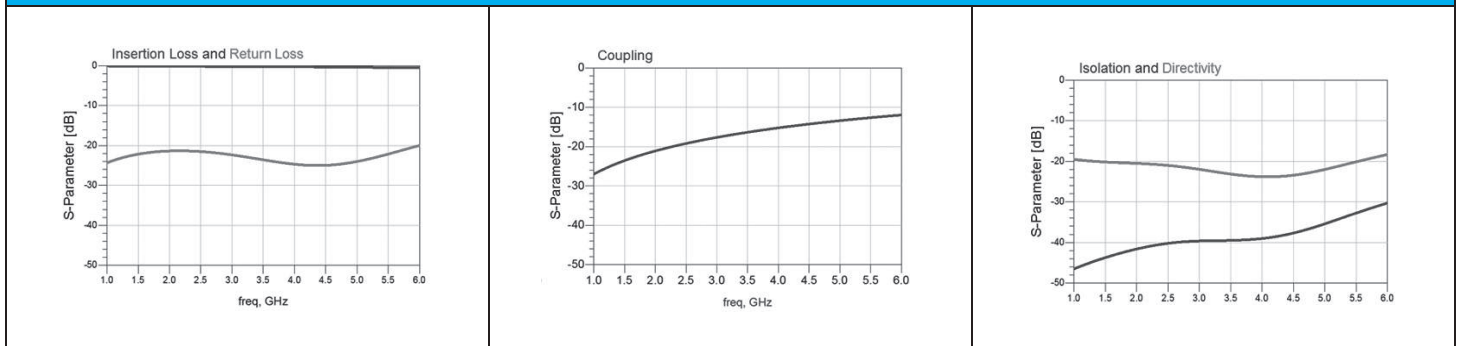

TFCPL0605030L28Q1C

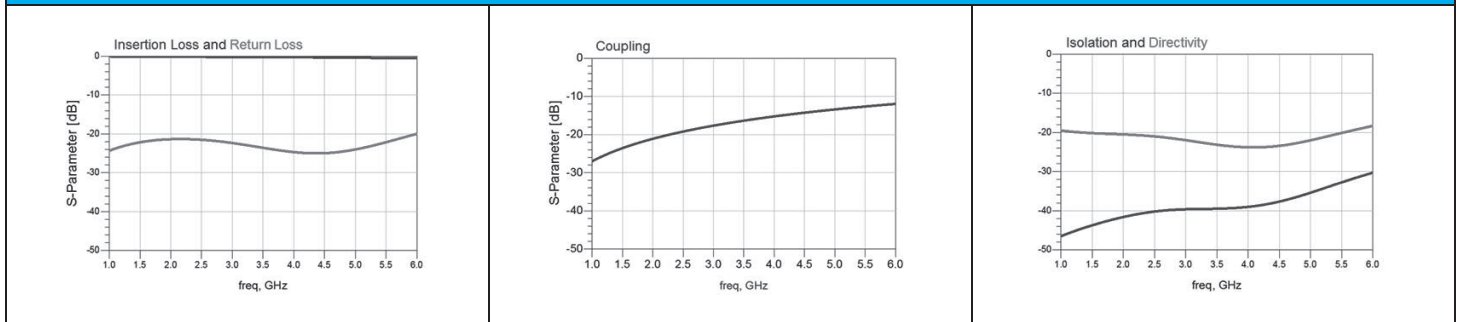

RFCL0605030L58Q1C

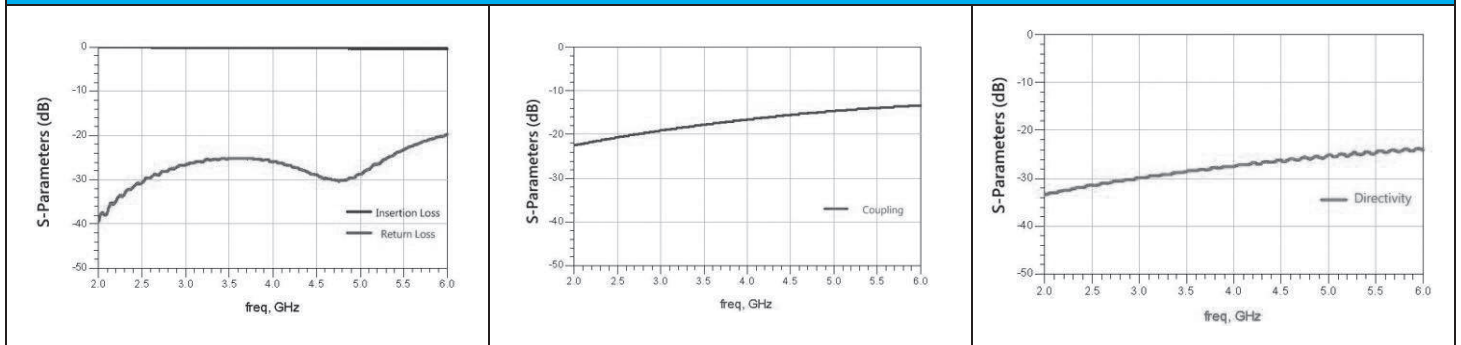

TYPICAL ELECTRICAL CHARACTERISTICS

RFCPL0605030L6T

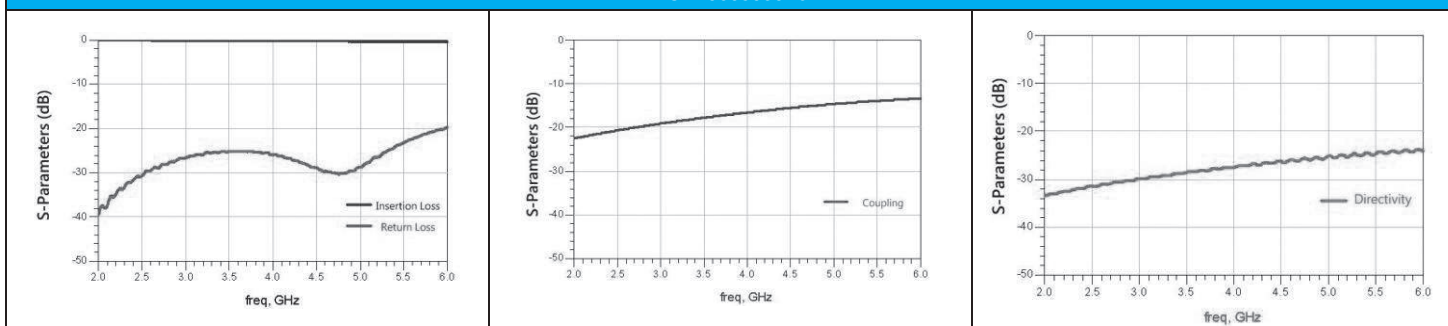

RFCPL0605030L9T

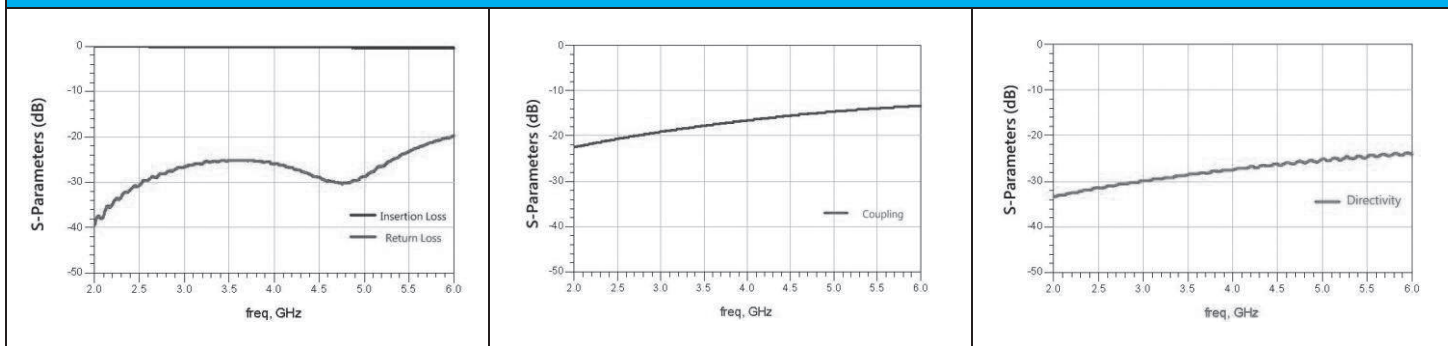

RFCPL1608070P08Q1C

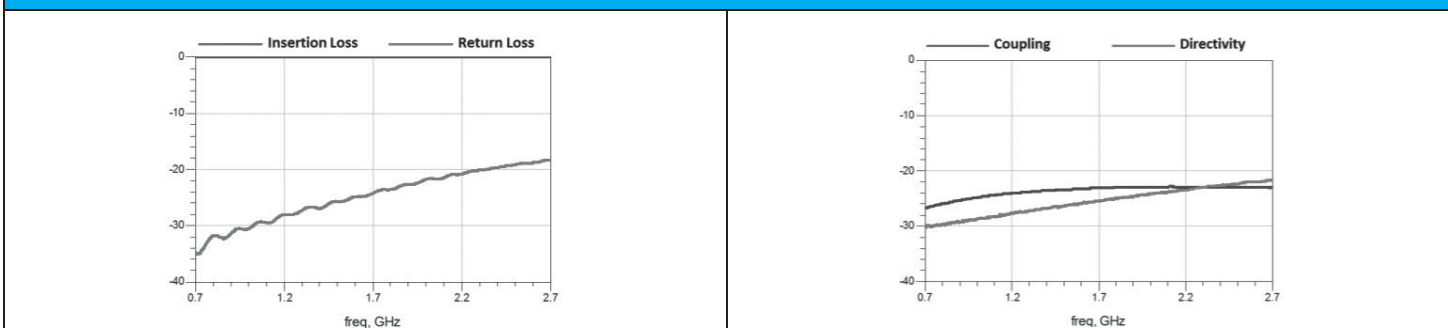

RFCPL1608070P18Q1C

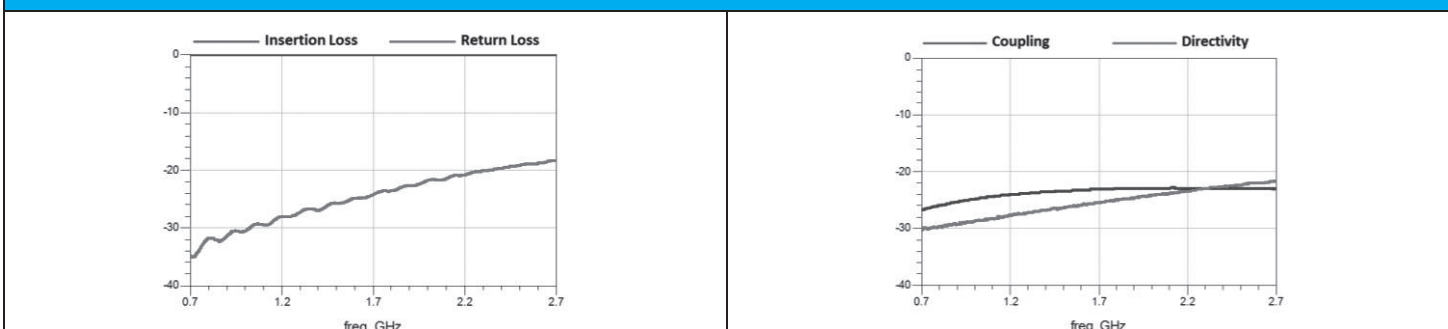

RFCPL1608070P28Q1C

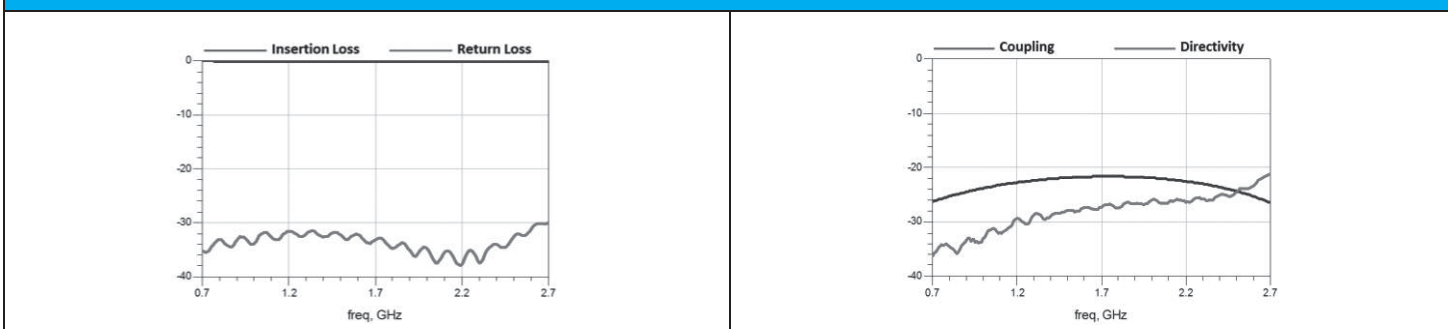

TYPICAL ELECTRICAL CHARACTERISTICS

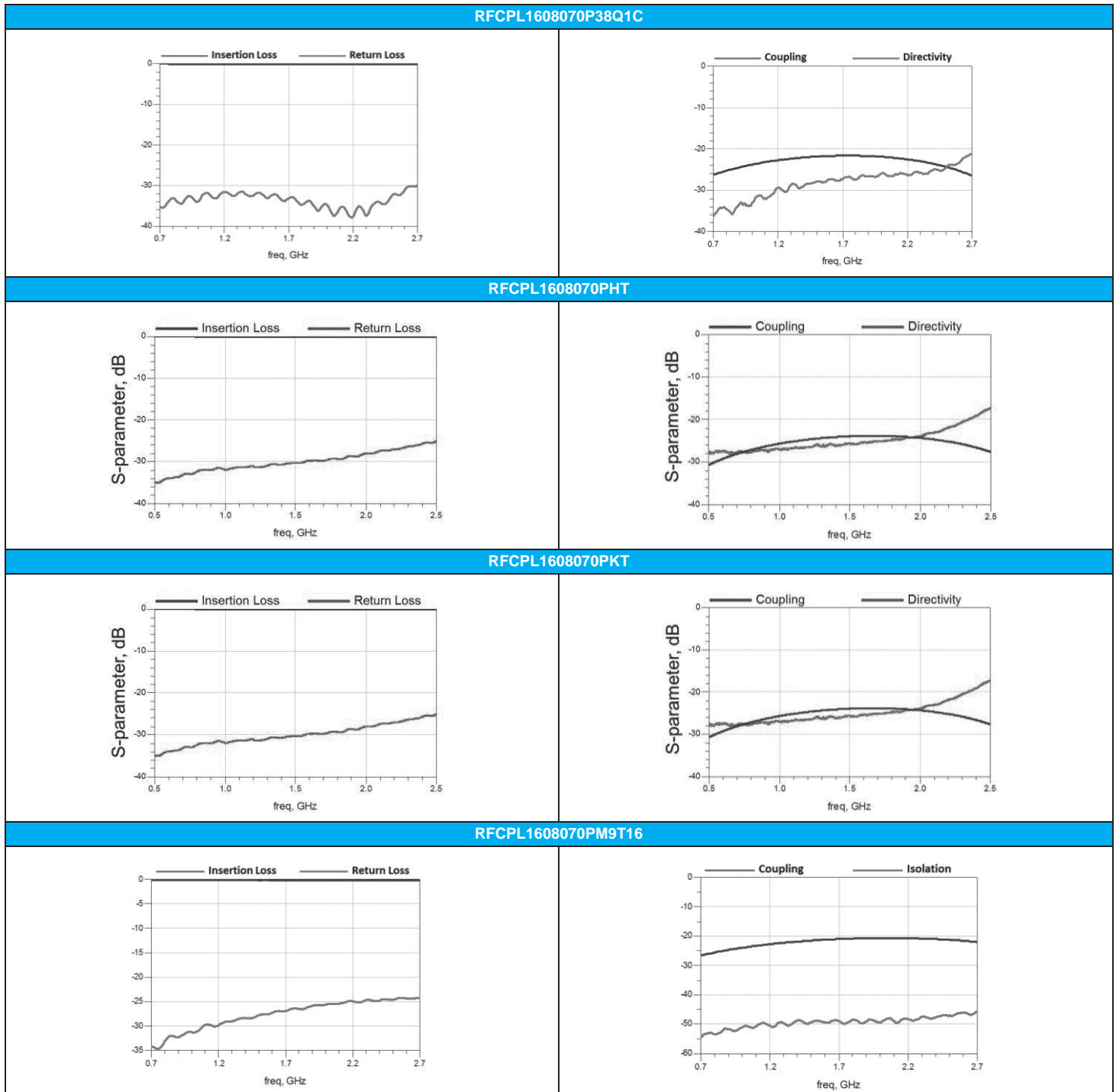

- For more information, please contact with local sales representative
- All specifications are subject to change without notice

SAW Filter

■ **STRUCTURE AND PIN ASSOCIATED**

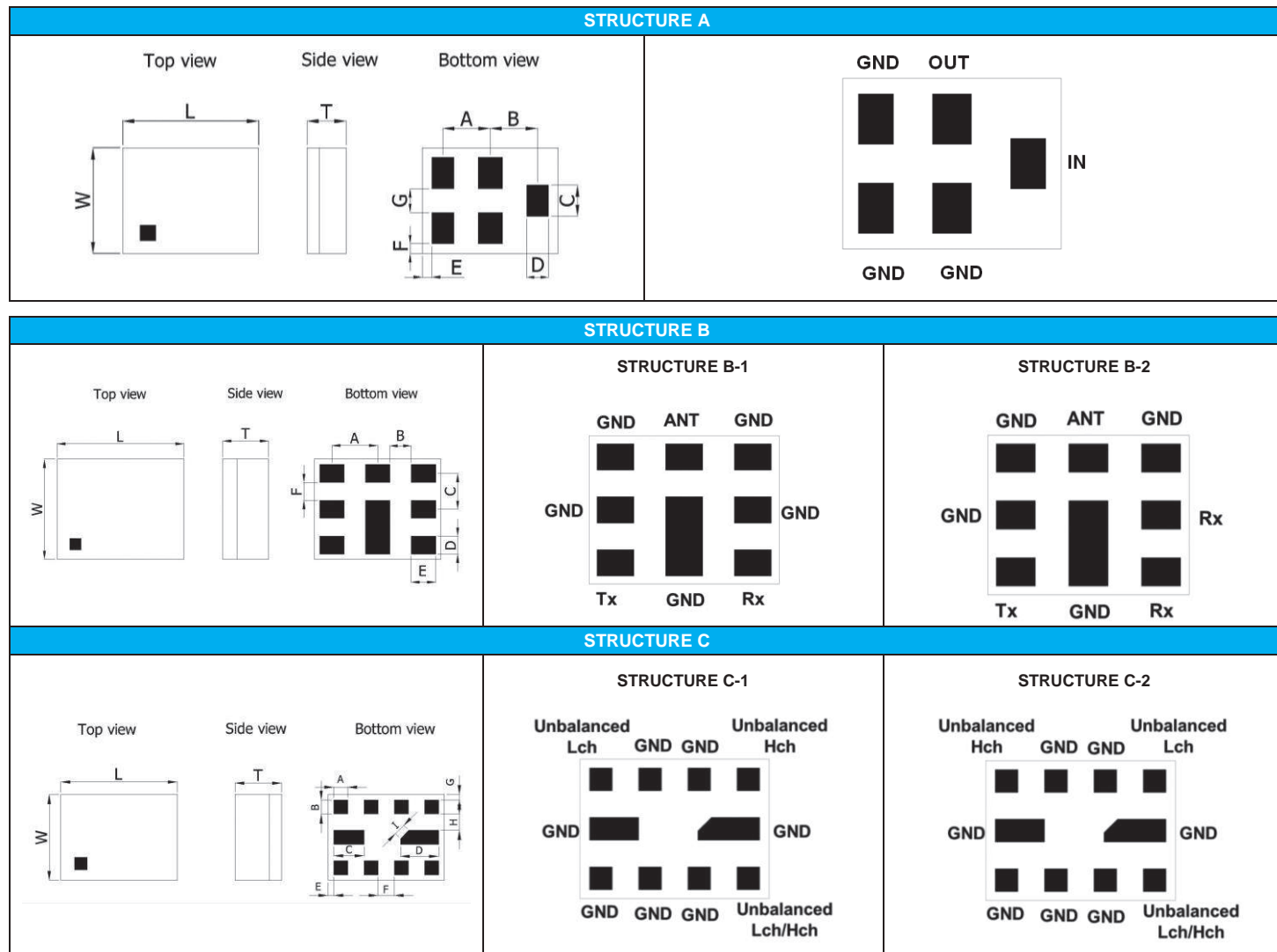

■ **STRUCTURE AND DIMENSION**

Unit: mm

Structure/Dimension	L	W	T	A	B	C	D	E	F	G	H	I
A	1.10±0.10	0.90±0.10	0.50max.	0.40	0.40	0.25	0.20	0.05	0.075	0.25	-	-
	1.40±0.13	1.10±0.13	0.65max.	0.50	0.50	0.325	0.25	0.075	0.10	0.25	-	-
B	1.80±0.10	1.40±0.10	0.65max.	0.65	0.30	0.50	0.25	0.35	0.25	-	-	-
C	1.50±0.10	1.10±0.10	0.60max.	0.18	0.18	0.39	0.49	0.075	0.21	0.07	0.21	0.15

■ **ELECTRICAL SPECIFICATION**

Application	Type	Part Number	Band	Frequency(MHz)	Package (mm)	STRUCTURE
GPS/Wifi	GPS SAW 3 Mode	SF11091582GC2T	GPS+G+C	1559.05~1605.89	1.1 x 0.9	A
	SAW	SF11092450A04T	WLAN	2400~2500	1.1 x 0.9	A
	SAW	SF14112450A03T	WLAN	2400~2500	1.4 x 1.1	A
FDD LTE	SAW Duplexer	DF18141950B102T	B1	1920~1980/2110~2170	1.8 x 1.4	B-1
	SAW Duplexer	DF18140836B507T	B5	824~849/869~894	1.8 x 1.4	B-1
	SAW Duplexer	DF18140897B801T	B8	880~915/925~960	1.8 x 1.4	B-1
	SAW Duplexer	DB18141950B105T	B1	1920~1980/2110~2170	1.8 x 1.4	B-2
	SAW Duplexer	DB18140836B510T	B5	824~849/869~894	1.8 x 1.4	B-2
	SAW Duplexer	DB18140897B804T	B8	880~915/925~960	1.8 x 1.4	B-2
FDD LTE	RX SAW	SF11092140B102T	B1	2110~2170	1.1 x 0.9	A
	RX SAW	SF11091960B201T	B2	1930~1990	1.1 x 0.9	A
	RX SAW	SF11091842B305T	B3	1805~1880	1.1 x 0.9	A
	RX SAW	SF11090881B506T	B5	869~894	1.1 x 0.9	A
	RX SAW	SF11092655B702T	B7	2620~2690	1.1 x 0.9	A
	RX SAW	SF11090942B805T	B8	925~960	1.1 x 0.9	A
TDD LTE	Rx Dual SAW	BF1511B394101AT	B39/B41	1880~1920/2550~2655	1.5 x 1.1	C-2
	Rx Dual SAW	BF1511B394101BT	B39/B41	1880~1920/2550~2655	1.5 x 1.1	C-1
TDD LTE	TRx SAW	SF14112595B3803T	B38	2570~2620	1.4 x 1.1	A
	TRx SAW	SF14112350B4001T	B40	2300~2400	1.4 x 1.1	A
	TRx SAW	SF14112605B41S4T	B41	2550~2655	1.4 x 1.1	A
	TRx SAW	SF14112017B3402T	B34	2010~2025	1.4 x 1.1	A
	TRx SAW	SF14111900B3906T	B39	1880~1920	1.4 x 1.1	A
	TRx SAW	SF11092595B3804T	B38	2570~2620	1.1 x 0.9	A
	TRx SAW	SF11092350B4004T	B40	2300~2400	1.1 x 0.9	A
	TRx SAW	SF11092605B4111T	B41	2550~2655	1.1 x 0.9	A
	TRx SAW	SF11092595B4108T	B41	2535~2655	1.1 x 0.9	A
	TRx SAW	SF11092017B3403T	B34	2010~2025	1.1 x 0.9	A
	TRx SAW	SF11091900B3907T	B39	1880~1920	1.1 x 0.9	A
	TDD LTE	Rx SAW	SF11092595B3805T	B38	2570~2620	1.1 x 0.9
Rx SAW		SF11092350B4005T	B40	2300~2400	1.1 x 0.9	A
Rx SAW		SF11092602B41W9T	B41	2550~2655	1.1 x 0.9	A

■ **TYPICAL ELECTRICAL CHARACTERISTICS**

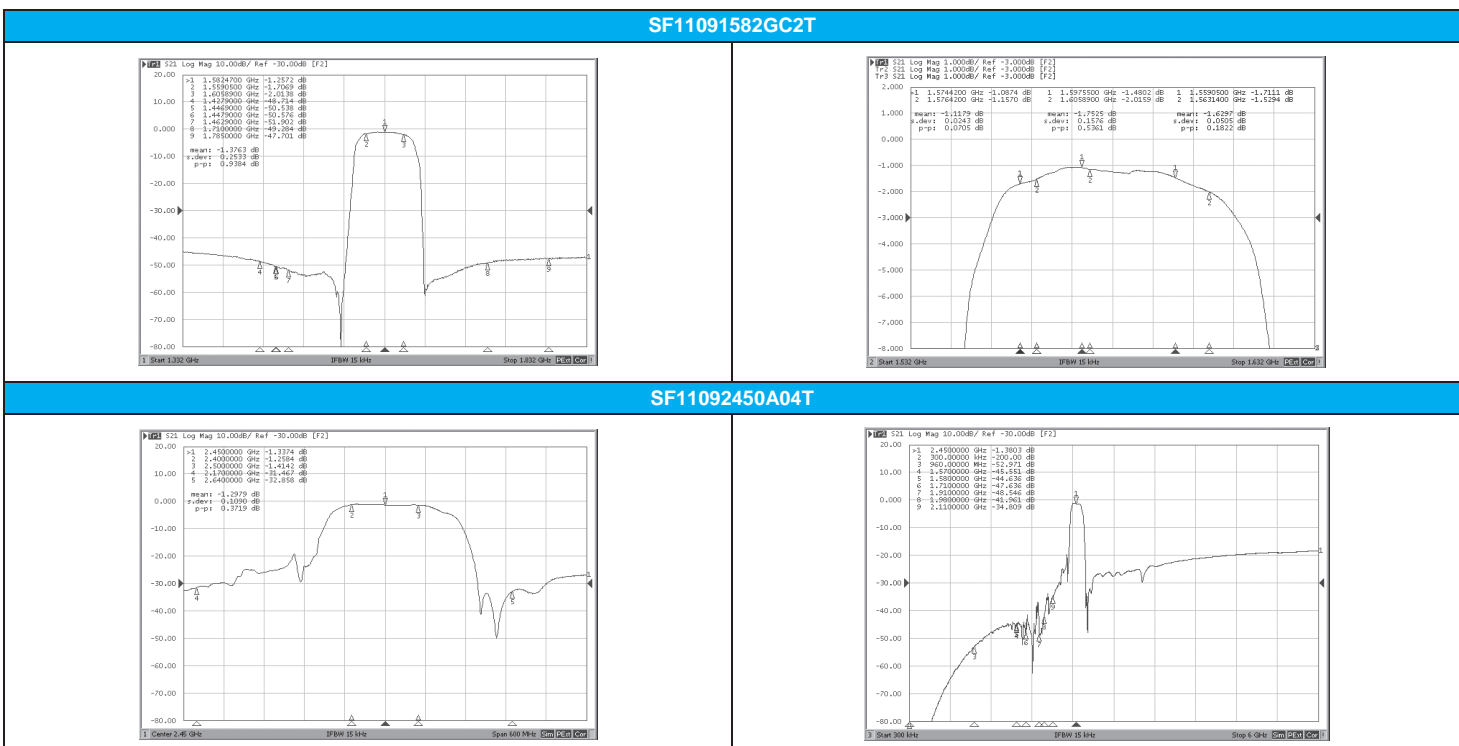

TYPICAL ELECTRICAL CHARACTERISTICS

SF14112450A03T

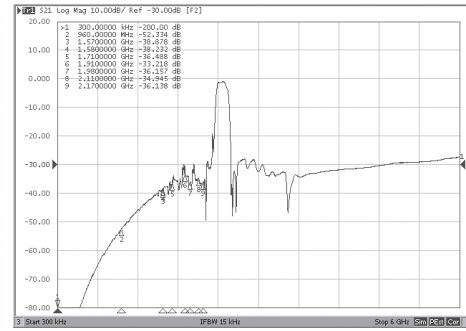
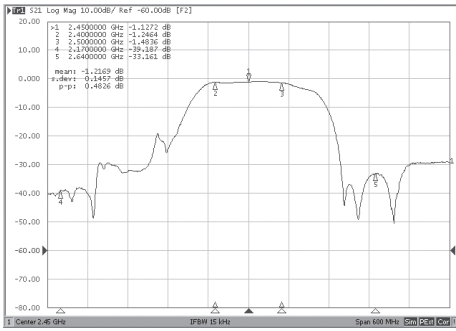

DF18141950B102T

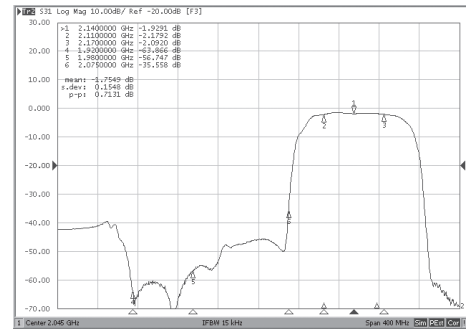
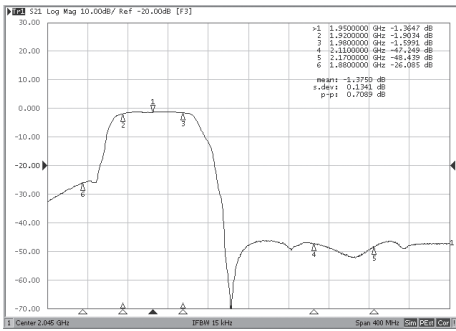

DF18140836B507T

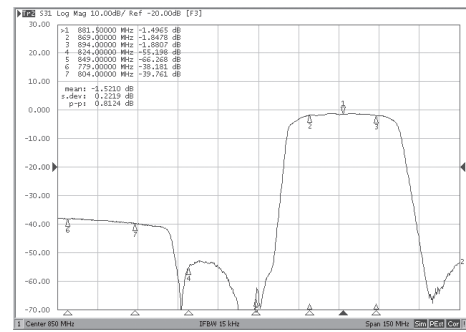
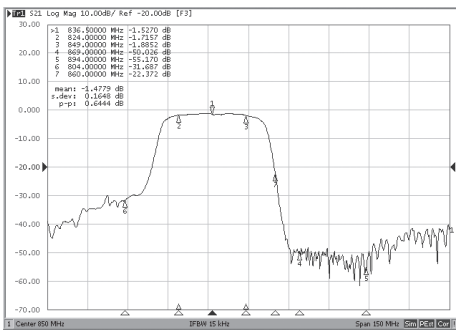

DF18140897B801T

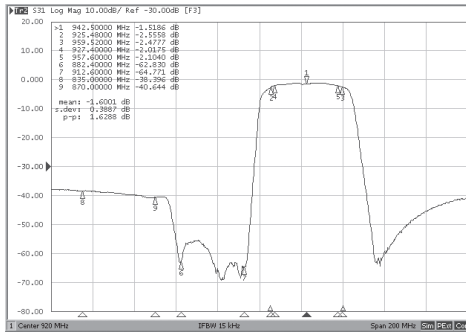
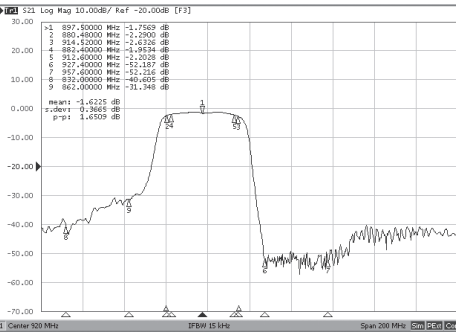

DB18141950B105T

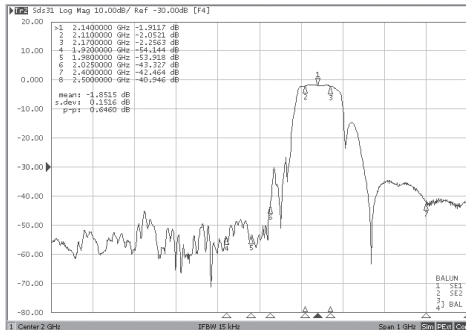
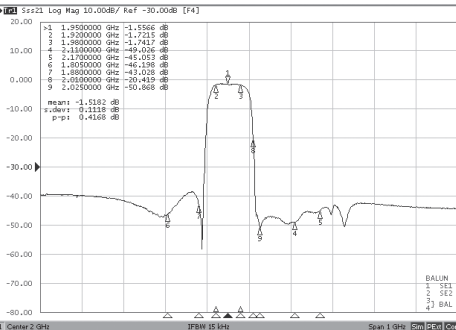

TYPICAL ELECTRICAL CHARACTERISTICS

DB18140386B510T

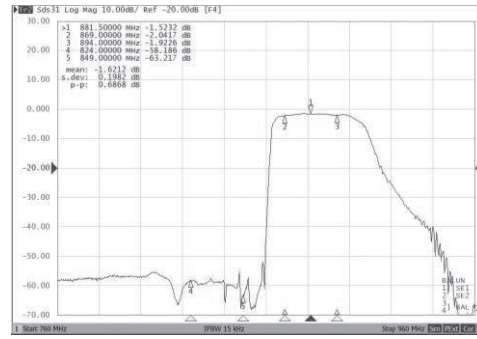

DB18140897B804T

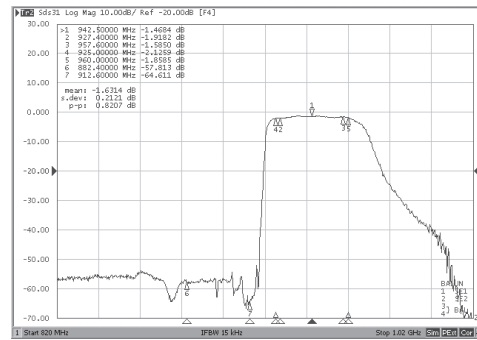
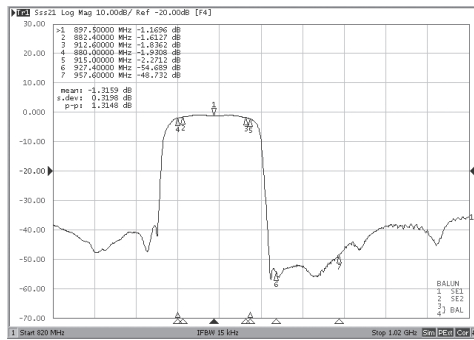

SF11092140B102T

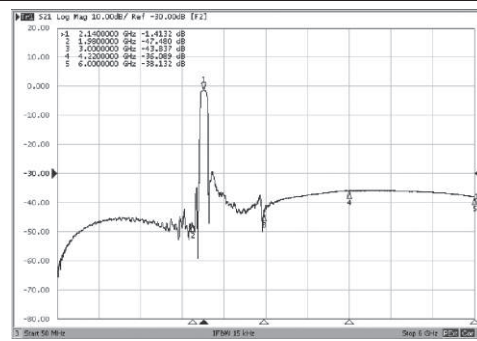

SF11091960B201T

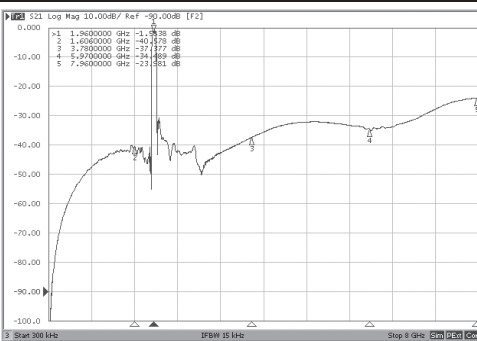
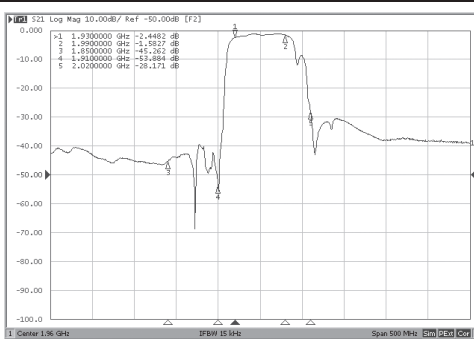

SF11091842B305T

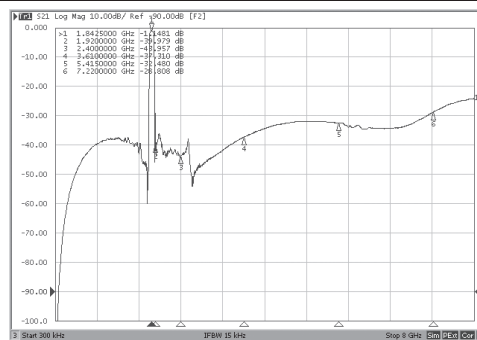
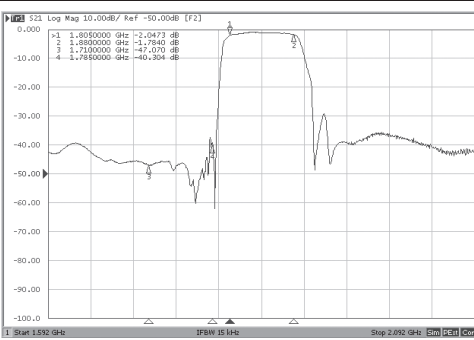

TYPICAL ELECTRICAL CHARACTERISTICS

SF11090881B506T

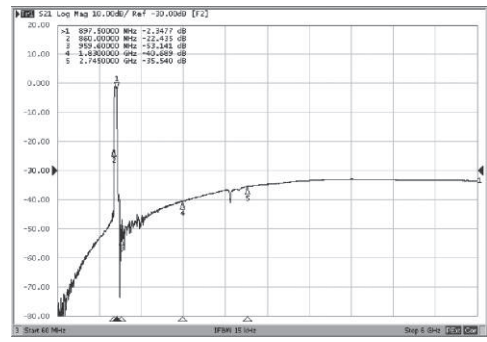
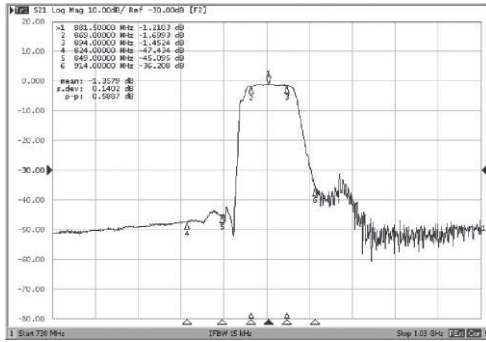

SF11092655B702T

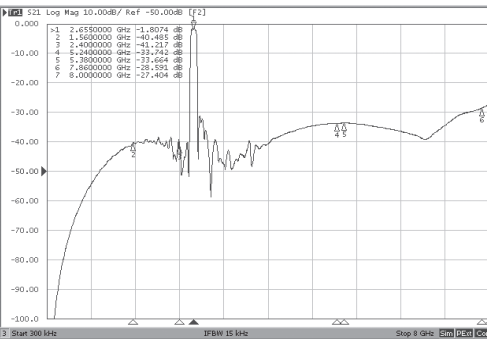
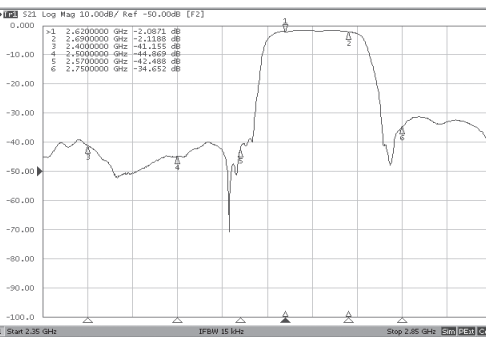

SF11090942B805T

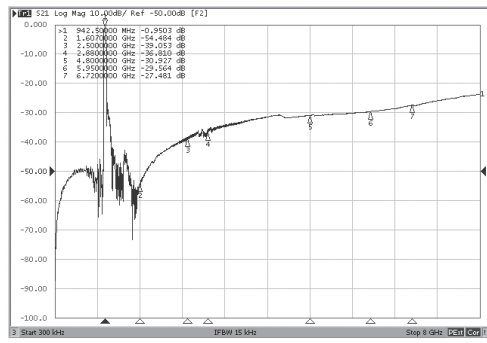
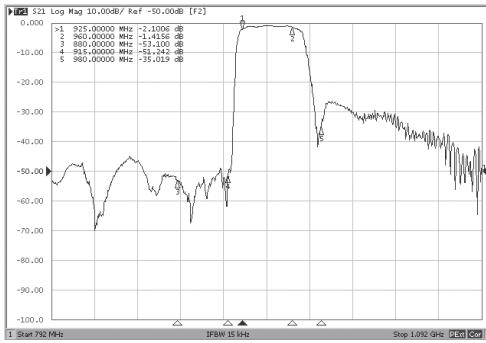

SF14112595B3803T

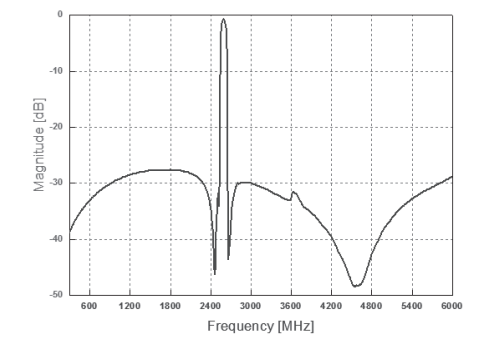
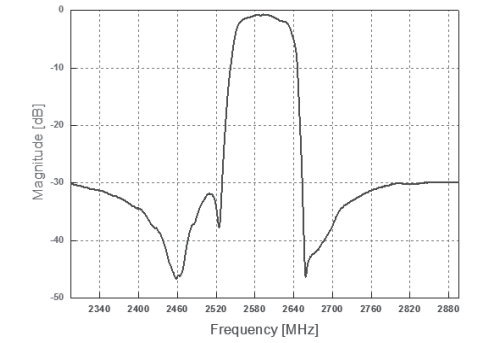

SF14112350B4001T

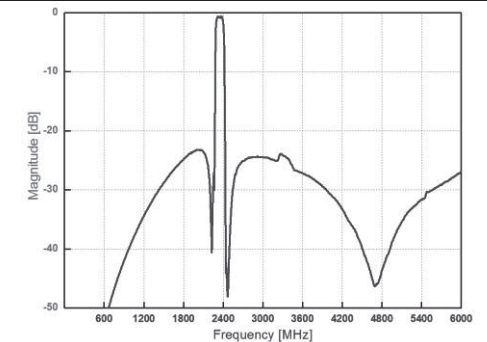
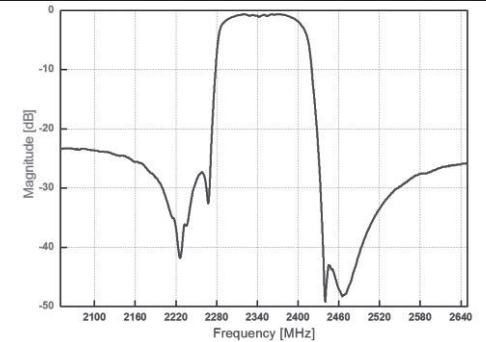

TYPICAL ELECTRICAL CHARACTERISTICS

SF14112605B41S4T

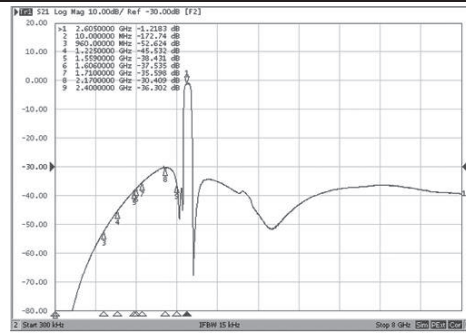
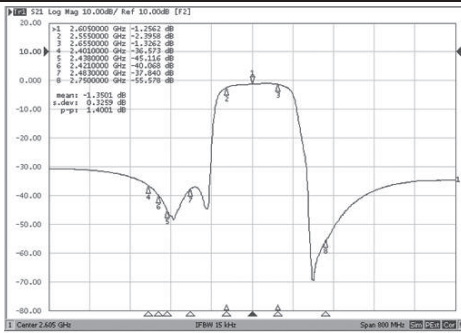

SF14112017B3402T

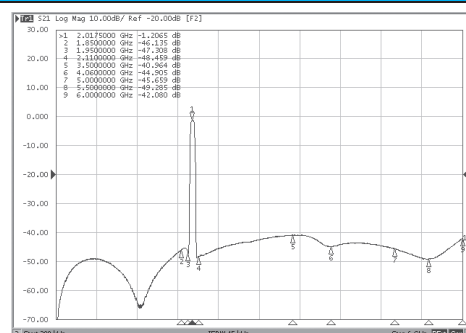
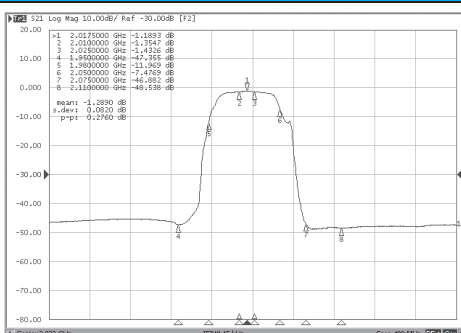

SF14111900B3906T

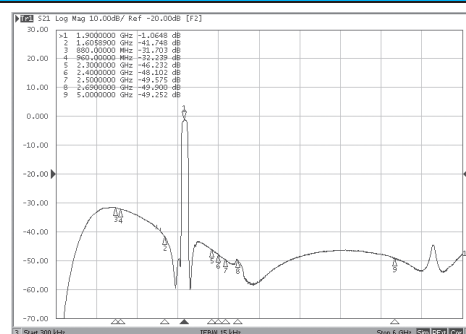
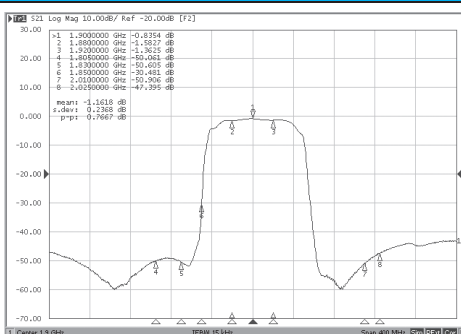

SF11092595B3804T

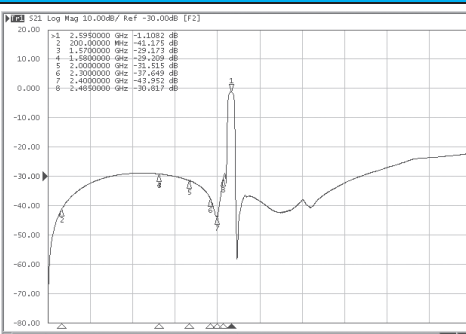
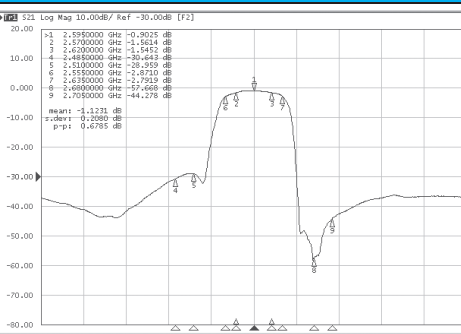

SF11092350B4004T

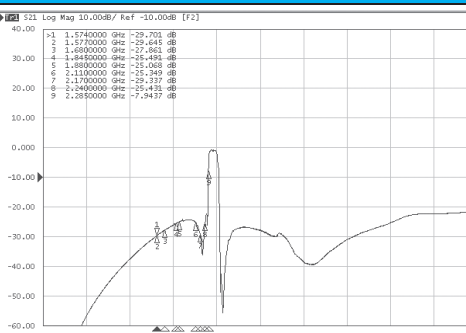
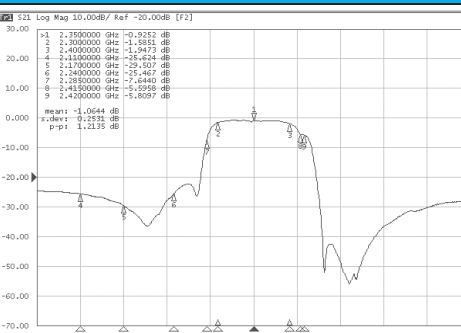

TYPICAL ELECTRICAL CHARACTERISTICS

SF11092605B4111T

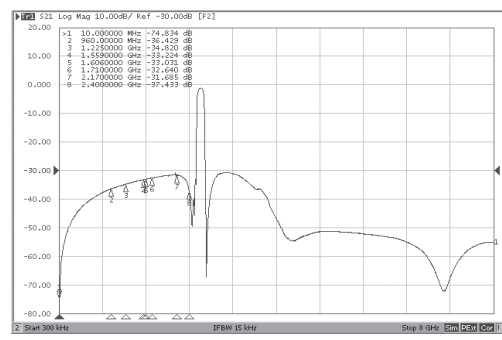
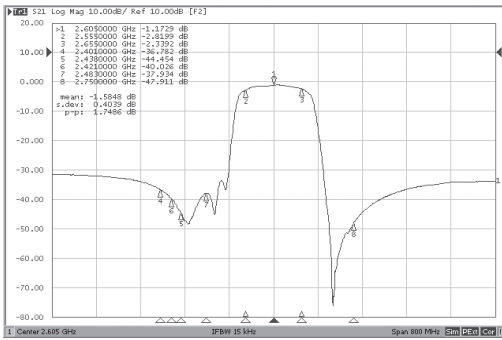

SF11092595B4108T

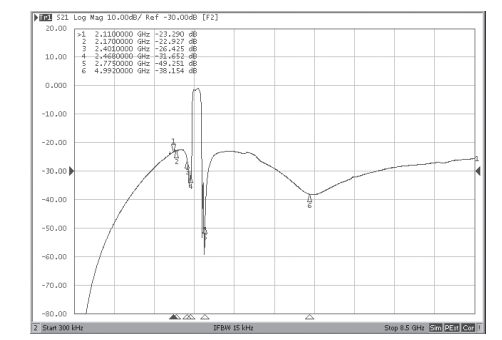
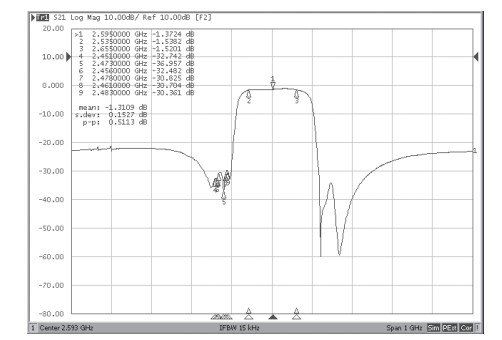

SF11092017B3403T

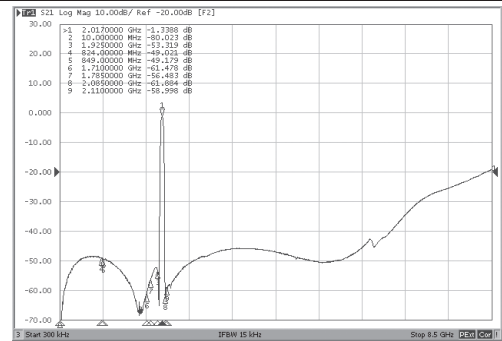
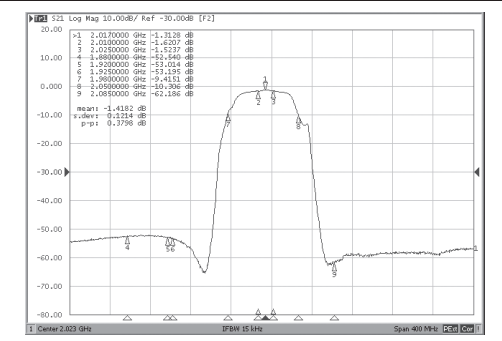

SF11091900B3907T

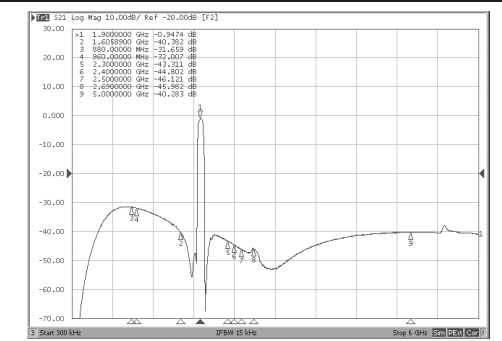
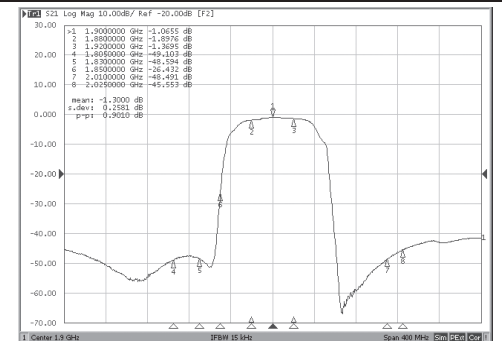

SF11092595B3805T

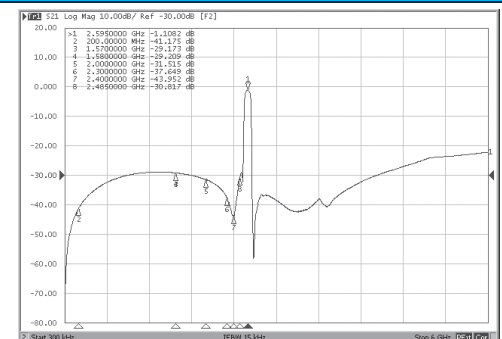
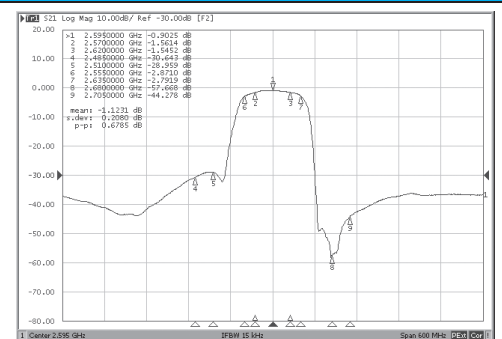

TYPICAL ELECTRICAL CHARACTERISTICS

SF11092350B4005T

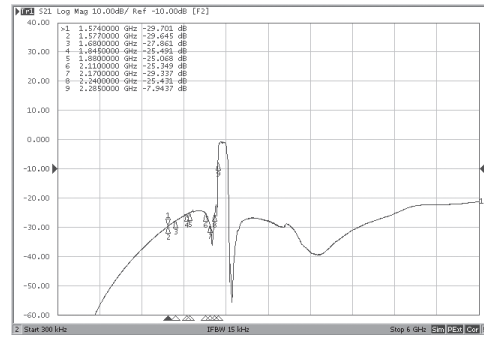
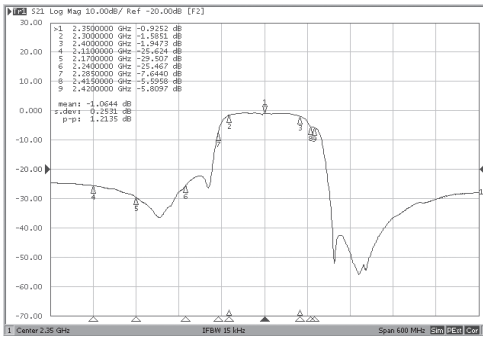

SF11092602B41W9T

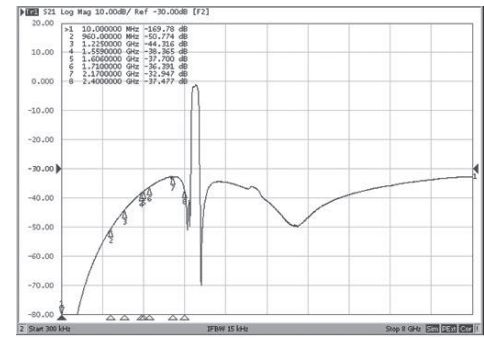
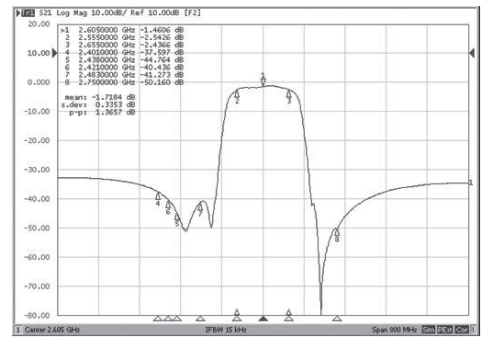

- For more information, please contact with local sales representative
- All specifications are subject to change without notice

ANTENNA SWITCH

■ **Application Circuit (GPIO)**

<p>RFASWA630ATF09</p>	<p>RFASWA630BTF09</p>	<p>RFASWA630CTF09</p>
<p>SPDT</p>	<p>SPDT</p>	<p>SPDT</p>
<p>RFASWA697ATF09</p>	<p>RFASWAH9628ATF09</p>	<p>RFASWAM3489ATF09</p>
<p>SPDT</p>	<p>SPDT</p>	<p>SPDT</p>
<p>RFASWMT2628ATF09</p>	<p>RFASWMT2628BTF09</p>	<p>RFASWMH6373ATF09</p>
<p>SP3T</p>	<p>SP3T</p>	<p>SP3T</p>
<p>RFASWKH4414ATF09</p>	<p>RFASWK626ATF09</p>	<p>RFASWHH1416ATF09</p>
<p>SP4T</p>	<p>SP4T</p>	<p>SP6T</p>
<p>RFASWHH1416PTF09</p>	<p>RFASWDH2418ATF09</p>	<p>RFASWDH2418PTF09</p>
<p>SP6T</p>	<p>SP8T</p>	<p>SP8T</p>

ANTENNA SWITCH

■ **Application Circuit (GPIO)**

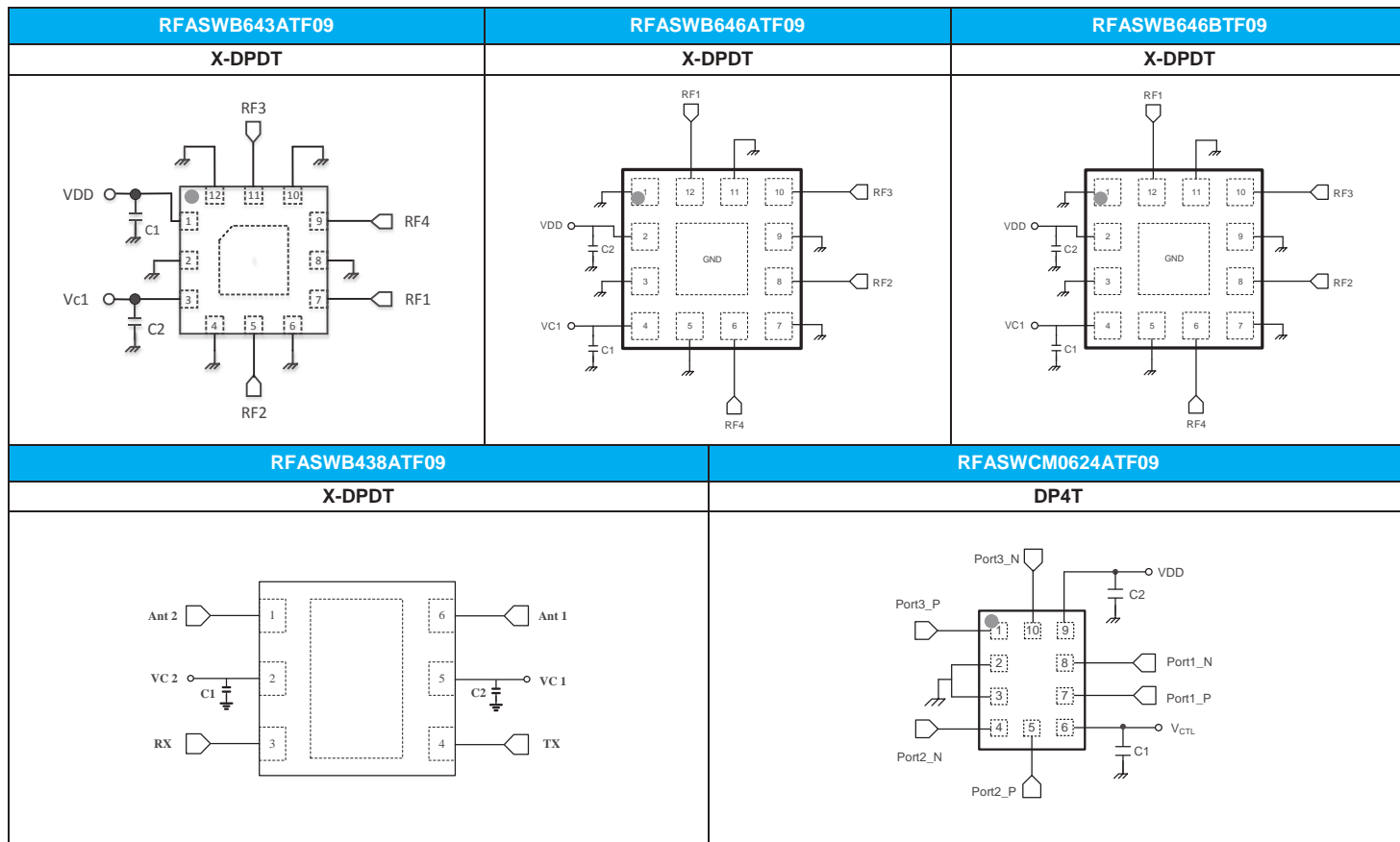

■ **ELECTRICAL SPECIFICATION**

Part Number	Description	Frequency (GHz)Min.	Frequency (GHz)Max.	Insertion loss	Isolation	VSWR	Package (mm)
				(dB)	(dB)		
RFASWA630ATF09	SPDT	0.1	2.7	0.30~0.50dB	20~30	1.20	1.1 x 0.7
RFASWA630BTF09		0.1	2.7	0.35~0.45dB	22~32	1.20	1.1 x 0.7
RFASWA630CTF09		0.1	2.7	0.35~0.45dB	22~32	1.20	1.1 x 0.7
RFASWA697ATF09		0.4	6	0.35~1.00dB	15~32	1.50	1.0 x 1.0
RFASWAH9628ATF09		0.5	2.7	0.30~0.50dB	20~30	1.43	1.1 x 1.1
RFASWAM3489ATF09		0.7	2.7	0.38~0.50dB	21~33	1.25	1.1 x 0.7
RFASWMT2628ATF09	SP3T	0.5	2.7	0.30~0.50dB	20~30	1.43	1.0 x 1.0
RFASWMT2628BTF09		0.8	2.7	0.30~0.70dB	14~26	1.50	1.0 x 1.0
RFASWMMH6373ATF09		0.5	6	0.32~0.80dB	15~32	1.40	2.0 x 2.0
RFASWKH4414ATF09	SP4T	0.1	2.7	0.45~0.70dB	22~33	1.22	2.0 x 2.0
RFASWK626ATF09		0.7	2.7	0.30~0.50dB	27~38	1.60	1.1 x 1.1
RFASWHH1416ATF09	SP6T	0.1	2.7	0.45~0.70dB	22~33	1.22	2.0 x 2.0
RFASWHH1416PTF09		0.1	4	0.35~0.80dB	21~35	1.50	2.0 x 2.0
RFASWDH2418ATF09	SP8T	0.1	2.7	0.30~0.50dB	25~34	1.22	2.0 x 2.0
RFASWDH2418PTF09		0.1	2.7	0.30~0.50dB	26~35	1.50	2.0 x 2.0
RFASWB643ATF09	X-DPDT	0.7	2.7	0.40~0.55dB	22~30	1.28	2.0 x 2.0
RFASWB646ATF09		0.7	3.8	0.40~0.70dB	25~33	1.20	1.8 x 1.8
RFASWB646BTF09		0.7	3.8	0.40~0.70dB	25~33	1.20	1.83 x 1.83
RFASWB438ATF09		0.1	6	0.50~1.20dB	13~28	1.43	1.5 x 1.5
RFASWCM0624ATF09	DP4T	0.824	0.96	0.25dB	28~38	1.50	1.1 x 1.5
		1.71	2.17	0.35dB	23~30	1.50	
		0.698	0.792	0.25dB	28~38	1.50	
		2.3	2.69	0.40dB	20~24	1.50	

■ **Application Circuit (MIPI)**

<p>RFASWH526ATF03</p>	<p>RFASWH526BTF03</p>	<p>RFASWH656DTF03</p>
<p>SP6T</p>	<p>SP6T</p>	<p>SP6T</p>
<p>RFASWD658ATF03</p>	<p>RFASWD658DTF03</p>	<p>RFASWD658FTF03</p>
<p>SP8T</p>	<p>SP8T</p>	<p>SP8T</p>
<p>RFASWET1562BTF03</p>	<p>RMASME494ATF03</p>	<p>RFASWE660ATF03</p>
<p>SP10T</p>	<p>SP10T</p>	<p>SP10T</p>
<p>RFASWE660DTF03</p>	<p>RMASMET2498ATF03</p>	<p>RFASWFT2563BTF03</p>
<p>SP10T</p>	<p>SP10T</p>	<p>SP12T</p>

■ **Application Circuit (MIPI)**

<p>RFASWF662ATF03</p>	<p>RFASWF662DTF03</p>	<p>RMASMF1488BTF03</p>
<p>SP12T</p>	<p>SP12T</p>	<p>SP12T</p>
<p>RMASMF496ATF03</p>	<p>RMASMP491ATF03</p>	<p>RMASMN1492ATF03</p>
<p>SP12T</p>	<p>SP14T</p>	<p>SP16T</p>
<p>RFASWV481CTF03</p>	<p>RFASWY581CTF03</p>	<p>RFASWR681CTF03</p>
<p>DP8T (SP4T+SP4T)</p>	<p>DP10T (SP5T+SP5T)</p>	<p>DP12T (SP6T+SP6T)</p>
<p>RMASMU532ATF03</p>	<p>RMASMU890ATF03</p>	<p>RMASMS535ATF03</p>
<p>DP14T (SP8T+SP6T)</p>	<p>DP14T (SP7T+SP7T)</p>	<p>DP21T (SP12T+SP9T)</p>

■ ELECTRICAL SPECIFICATION

Part Number	Description	Frequency (GHz) Min.	Frequency (GHz) Max.	Insertion loss (dB) TRXx ports	Isolation (TRXx to any off TRXx port) [non-adjacent ports]	Isolation (TRXx to any off TRXx port) [adjacent ports]	VSWR	Package (mm)
RFASWH526ATF03	SP6T	0.4	2.7	0.40~0.76dB(600~2690MHz)	20~30	17~26	2	2.0 x 2.0
RFASWH526BTF03		0.4	2.7	0.40~0.76dB(400~2690MHz)	20~30	17~26	2	2.0 x 2.0
RFASWH656DTF03		0.4	2.7	0.40~0.76dB(704~2690MHz)	20~30	17~26	2	2.0 x 2.0
RFASWD658ATF03	SP8T	0.4	2.7	0.40~0.76dB(704~2690MHz)	20~30	17~26	2	2.0 x 2.0
RFASWD658DTF03		0.4	2.7	0.40~0.76dB(704~2690MHz)	20~30	17~26	2	2.0 x 2.0
RFASWD658FTF03		0.4	2.7	0.40~0.76dB(704~2690MHz)	20~30	17~26	2	2.0 x 2.0
RFASWET1562BTF03	SP10T	0.4	2.7	0.50~0.80dB(700~2690MHz)	25~35	20~26	2	2.5 x 2.5
RMASME494ATF03		0.4	2.7	0.60~0.85dB(824~2690MHz)	23~30	20~26	2	2.5 x 2.5
RFASWE660ATF03		0.7	2.7	0.45~0.75dB(700~2700MHz)	21~29	20~28	2	2.4 x 2.4
RFASWE660DTF03		0.7	2.7	0.45~0.75dB(700~2700MHz)	18~26	18~26	2	2.4 x 2.4
RMASMET2498ATF03		0.4	2.7	0.60~0.90dB(824~2690MHz)	23~30	20~26	2	2.5 x 2.5
RFASWFT2563BTF03		0.4	2.7	0.50~0.80dB(700~2690MHz)	25~35	20~26	2	2.5 x 2.5
RFASWF662ATF03	SP12T	0.4	2.7	0.50~0.72dB(700~2690MHz)	20~32	17~25	2	2.5 x 2.5
RFASWF662DTF03		0.4	2.7	0.50~0.72dB(700~2690MHz)	20~30	16~23	2	2.5 x 2.5
RMASMFT1488BTF03		0.4	2.7	0.60~0.90dB(824~2690MHz)	23~30	20~26	2	2.5 x 2.5
RMASMF496ATF03		0.4	2.7	0.60~0.85dB(824~2690MHz)	23~30	20~26	2	2.5 x 2.5
RMASMP491ATF03		SP14T	0.4	2.7	0.70~1.15dB(700~2690MHz)	20~30	16~20	2
RMASMNT1492ATF03	SP16T	0.4	2.7	0.60~1.00dB(824~2690MHz)	20~30	16~20	2	2.5 x 3.3
RFASWV481CTF03	DP8T (SP4T+SP4T)	0.4	2.7	0.45~0.75dB(400~2700MHz)	18~26	30~35	2	2.4 x 2.0
RFASWY581CTF03	DP10T (SP5T+SP5T)	0.4	2.7	0.45~0.75dB(400~2700MHz)	18~26	30~35	2	2.4 x 2.0
RFASWR681CTF03	DP12T (SP6T+SP6T)	0.4	2.7	0.45~0.75dB(400~2700MHz)	17~28	25~36	2	2.4 x 2.0
RMASMU532ATF03	DP14T (SP8T+SP6T)	0.4	2.7	0.65~1.15dB(704~2690MHz)	17~23	14~21	1.5	2.8 x 2.8
RMASMU890ATF03	DP14T (SP7T+SP7T)	0.4	2.7	0.60~0.85dB(600~2690MHz)	18~25	15~23	1.5	3.2 x 2.8
RMASMS535ATF03	DP21T (SP12T+SP9T)	0.7	3.0	0.65~1.10dB(824~2690MHz)	15~23	14~21	2	3.6 x 2.8

■ Application Circuit (LTE Antenna Tuner-GPIO)

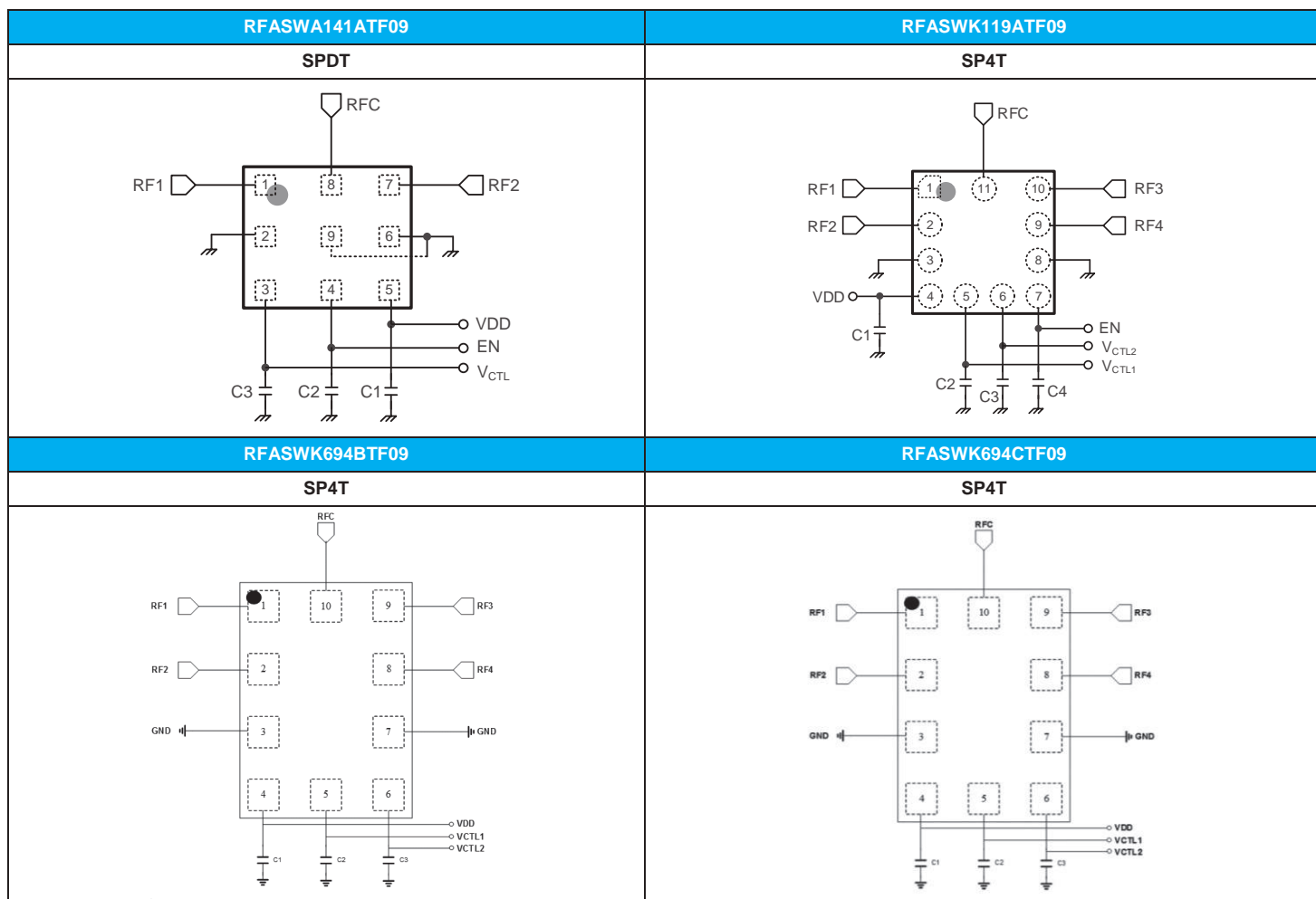

■ ELECTRICAL SPECIFICATION

Part Number	Description	Frequency (GHz) Min.	Frequency (GHz) Max.	Insertion loss (dB)	Isolation	VSWR	Package (mm)
RFASWA141ATF09	SPDT	0.4	3.0	0.20~0.35dB(700~2700MHz)	11~21	1.22	1.67 x 1.47
RFASWK119ATF09	SP4T	0.4	3.0	0.40~0.75dB(1000~2700MHz)	14~24	1.78	1.6 x 1.6
RFASWK694BTF09	SP4T	0.5	2.7	0.30~0.67dB(615~2700MHz)	16~22	1.58	1.1 x 1.5
RFASWK694CTF09	SP4T	0.5	2.7	0.30~0.67dB(615~2700MHz)	16~22	1.58	1.1 x 1.5

■ **Application Circuit (Network-GPIO)**

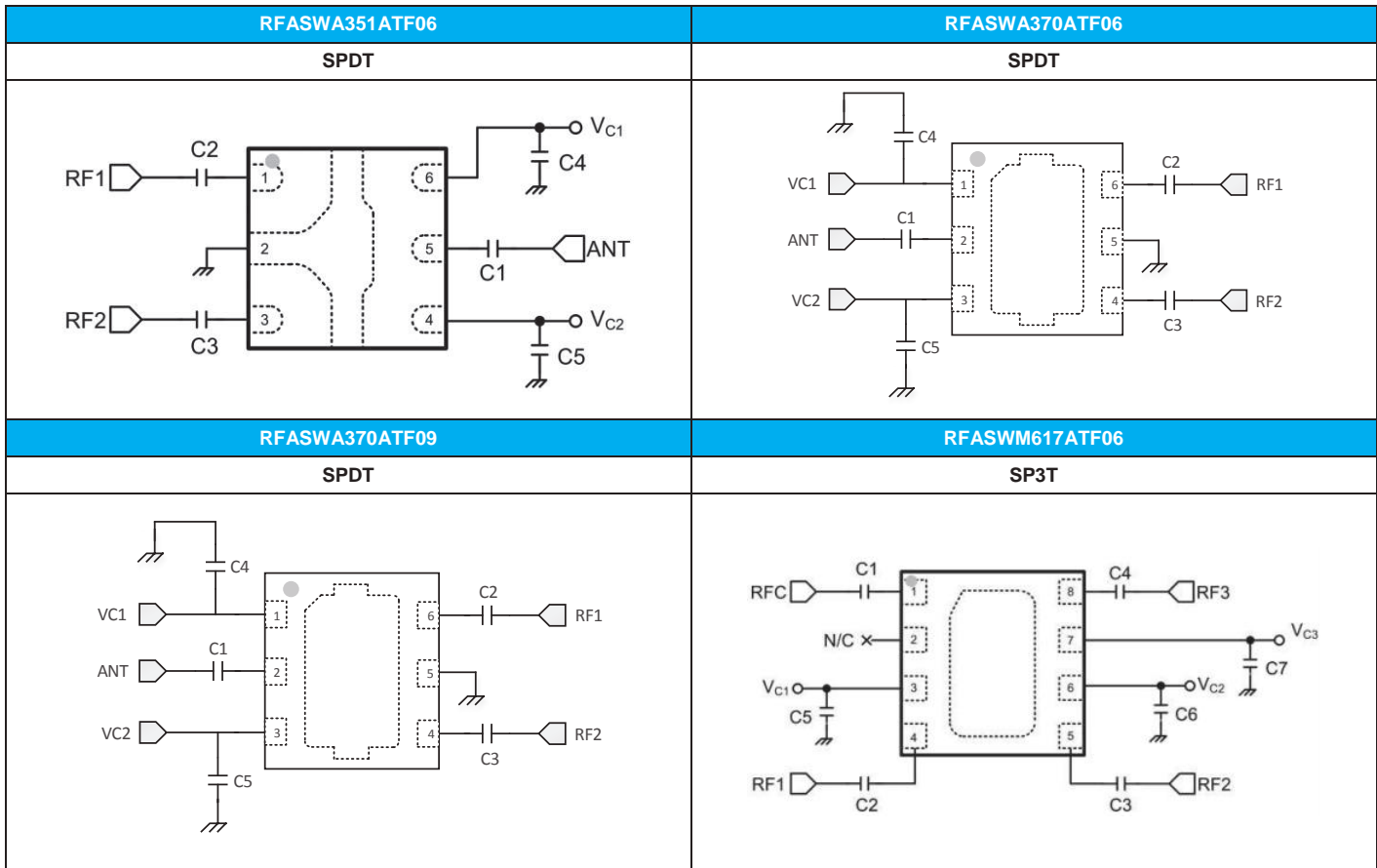





■ **ELECTRICAL SPECIFICATION**

Part Number	Description	Frequency (GHz) Min.	Frequency (GHz) Max.	Insertion loss (dB)	Isolation	VSWR	Package (mm)
RFASWA351ATF06	SPDT	0.5	6.0	0.35~0.70dB(500~6000MHz)	15~25	2	1.0 x 1.0
RFASWA370ATF06	SPDT	0.5	6.0	0.50~0.90dB(500~5850MHz)	23~28.5	1.67	1.5 x 1.5
RFASWA370ATF09	SPDT	0.5	6.0	0.70~1.15dB(500~5850MHz)	25~32	1.67	1.5 x 1.5
RFASWM617ATF06	SP3T	0.5	6.0	0.35~0.65dB(500~6000MHz)	15~30	1.92	1.5 x 1.5

DIPOLE ANTENNA (N/SMA)

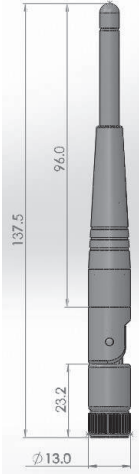
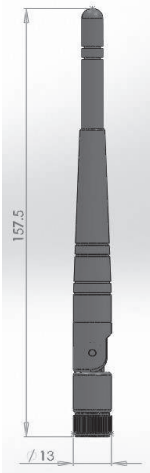
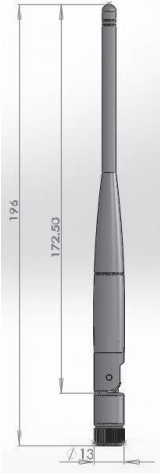
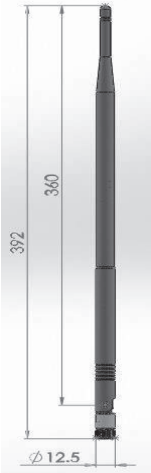
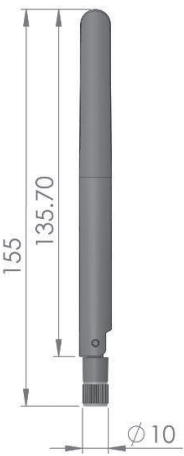
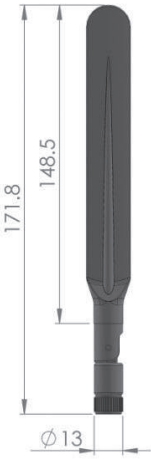
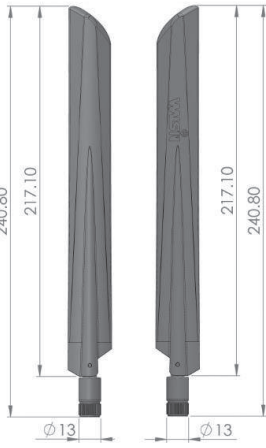
■ **ELECTRICAL SPECIFICATION**

Series	Size(mm)		Working Frequency Range	Gain	VSWR	Return Loss
	L	Ø				
8709	87	9.95	2.4~2.5 GHz	2dBi	<2	<-10dB
			2.4~2.5/5.x GHz	2.4~2.5 GHz : 2dBi 5.15~5.85 GHz : 3dBi	<2	<-10dB
1313	137.5	13	2.4~2.5 GHz	3dBi	<2	<-10dB
			2.4~2.5/5.x GHz	2.4~2.5 GHz : 3dBi 5.15~5.85 GHz : 3dBi	<2	<-10dB
1513	157.5	13	2.4~2.5 GHz	3dBi	<2	<-10dB
			2.4~2.5/5.x GHz	2.4~2.5 GHz : 3dBi 5.15~5.85 GHz : 3dBi	<2	<-10dB
1713	172.5	13	2.4~2.5 GHz	3dBi	<2	<-10dB
			2.4~2.5/5.x GHz	2.4~2.5 GHz : 4dBi 5.15~5.85 GHz : 5dBi	<2	<-10dB
3913	392	12.5	2.4~2.5 GHz	9dBi	<2	<-10dB
1310	135.7	10	2.4~2.5 GHz	5dBi	<2	<-10dB
			5.x GHz	5dBi	<2	<-10dB
			2.4~2.5/5.x GHz	3dBi~4dBi	<2	<-10dB
			LTE	3dBi	<3	<-6dB
1413	148.5	13	2.4~2.5 GHz	3dBi	<2	<-10dB
			5.x GHz	3dBi	<2	<-10dB
			2.4~2.5/5.x GHz	3dBi	<2	<-10dB
			LTE	3dBi	<3	<-6dB
1913	196.6	13	2.4~2.5 GHz	5dBi	<2	<-10dB
			2.4~2.5/5.x GHz	2.4~2.5 GHz : 4dBi 5.15~5.85 GHz : 5dBi	<2	<-10dB
2213	217.1	13	2.4~2.5/5.x GHz	2.4~2.5 GHz : 5dBi 5.15~5.85 GHz : 4dBi	<2	<-10dB
			2.4~2.5 GHz	6dBi	<2	<-10dB
			2.4~2.5/5.x GHz	7dBi	<2	<-10dB
			5.x GHz	7dBi	<2	<-10dB
			LTE	5dBi	<3	<-6dB
2220	220	20	2.4 GHz	5dBi	<2	<-10dB
			5.x GHz	5dBi	<2	<-10dB
			2.4~2.5 GHz	7dBi	<2	<-10dB
2520	25	20	2.4 GHz	5~7dBi	<2	<-10dB
			5.x GHz	7dBi	<2	<-10dB
			2.4~2.5 GHz (High Gain)	7dBi	<2	<-10dB

8709	1313	1513	1713	3913
				
1310	1413	2213	2220	2520
				
1913				
				

DIPOLE ANTENNA (Cable)

■ **ELECTRICAL SPECIFICATION**

Series	Size(mm)		Working Frequency Range	Gain	VSWR	Return Loss
	L	Ø				
8709	87	9.35	2.4~2.5 GHz	2dBi	<2	<-10dB
			2.4~2.5/5.x GHz	2.4~2.5 GHz : 2dBi 5.15~5.85 GHz : 3dBi	<2	<-10dB
1313	133	9.35	2.4~2.5 GHz	3dBi	<2	<-10dB
			2.4~2.5/5.x GHz	2.4~2.5 GHz : 3dBi 5.15~5.85 GHz : 3dBi	<2	<-10dB
1513	152	9.35	2.4~2.5 GHz	3dBi	<2	<-10dB
			2.4~2.5/5.x GHz	2.4~2.5 GHz : 3dBi 5.15~5.85 GHz : 3dBi	<2	<-10dB
1514	158	14	2.4~2.5/5.x GHz	2.4~2.5 GHz : 5dBi 5.15~5.85 GHz : 7dBi	<2	<-10dB
1713	172	9.35	2.4~2.5 GHz	3dBi	<2	<-10dB
			2.4~2.5/5.x GHz	2.4~2.5 GHz : 4dBi 5.15~5.85 GHz : 5dBi	<2	<-10dB
1310	135.7	10	2.4~2.5 GHz	5dBi	<2	<-10dB
			5.x GHz	5dBi	<2	<-10dB
			2.4~2.5/5.x GHz	3dBi~4dBi	<2	<-10dB
			LTE	3dBi	<3	<-6dB
1913	192	9.35	2.4~2.5 GHz	5dBi	<2	<-10dB
			2.4~2.5/5.x GHz	2.4~2.5 GHz : 4dBi 5.15~5.85 GHz : 5dBi	<2	<-10dB

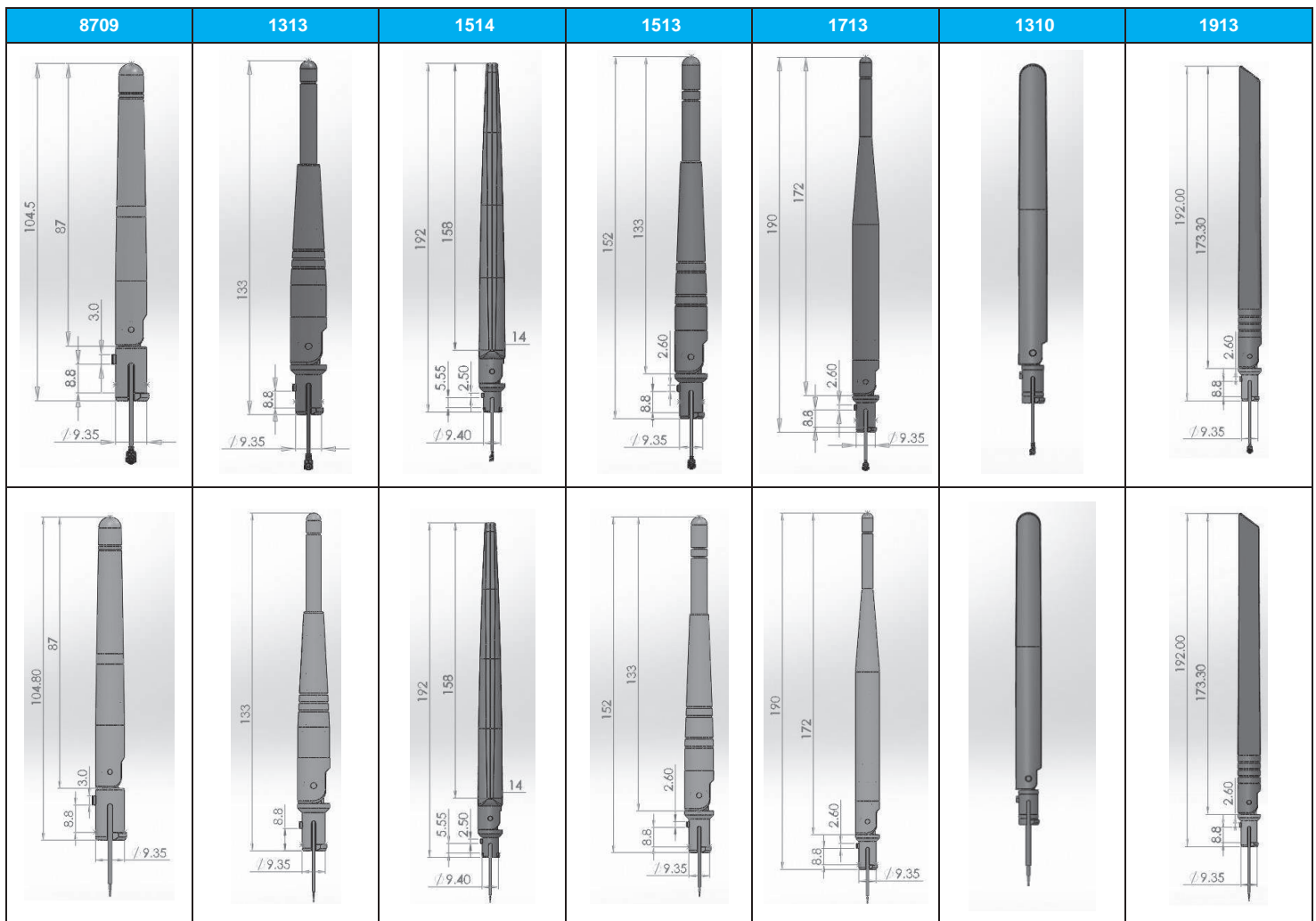

Cable Assembly

■ **ELECTRICAL SPECIFICATION**

Series	Connector 1	Connector 2	Wire Diameter	Color	L	Working Frequency Range	VSWR
1006	Straight Reverse SMA Jack	IPEX(or Strip & Tin)	Ø1.13/Ø1.37/RG178	Option	Option	DC ~ 6 GHz	2.0
1106	Straight Reverse SMA Jack	IPEX(or Strip & Tin)	Ø1.13/Ø1.37/RG178	Option	Option	DC ~ 6 GHz	2.0
1613	R/A Reverse SMA Jack	IPEX(or Strip & Tin)	Ø1.13/Ø1.37/RG178	Option	Option	DC ~ 6 GHz	2.0
0403	IPEX	IPEX(or Strip & Tin)	Ø0.81/Ø1.13/Ø1.37/RG178	Option	Option	DC ~ 6 GHz	2.0
0202	IPEX III	IPEX(or Strip & Tin)	Ø0.81	Option	Option	DC ~ 6 GHz	2.0
xxxx	Strip & Tin	Strip & Tin	Ø0.81/Ø1.13/Ø1.37/RG178	Option	Option	DC ~ 6 GHz	2.0
1015	N Jack	MMCX(or Strip & Tin)	RG316	Option	Option	DC ~ 6 GHz	2.0
1008	Straight Reverse SMA Plug	IPEX(or Strip & Tin)	RG405	Option	Option	DC ~ 6 GHz	2.0

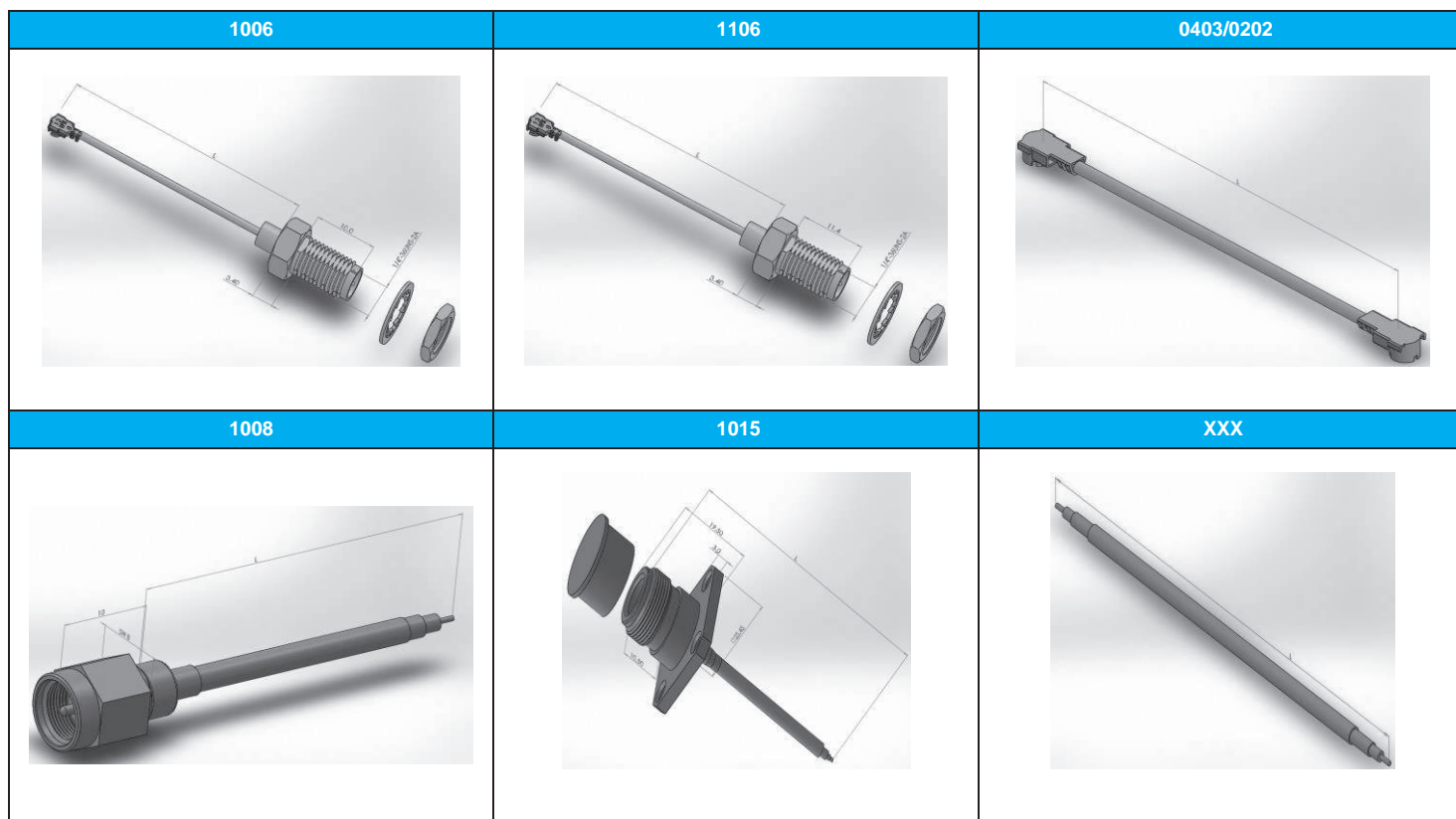

1613

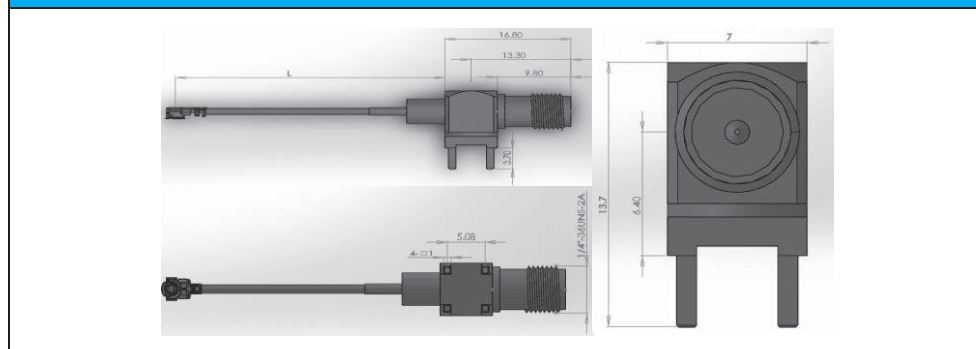

PCB Antenna

■ ELECTRICAL SPECIFICATION

Series	PCB Size(mm)		Cable Length(mm) L	Working Frequency Range	Gain	VSWR	Return Loss
	L	w					
2313	23	13	Option	5 GHz	3dBi	<2	<-10dB
4305	43	5	Option	2.4~2.5 GHz	2dBi	<2	<-10dB
2010	20.1	10	Option	5 GHz	3dBi	<2	<-10dB
5010	50	10	Option	2.4~2.5 GHz	3dBi	<2	<-10dB
4308	43	8.3	Option	2.4~2.5/5.x GHz	2.4~2.5 GHz : 2dBi 5.x GHz : 3dBi	<2	<-10dB
4606	46.5	6	Option	2.4~2.5 GHz	2dBi	<2	<-10dB
3513	35	13	Option	2.4~2.5 GHz	4dBi	<2	<-10dB
3515	35	15	Option	2.4~2.5/5.x GHz	2.4~2.5 GHz : 2dBi 5.x GHz : 3dBi	<2	<-10dB

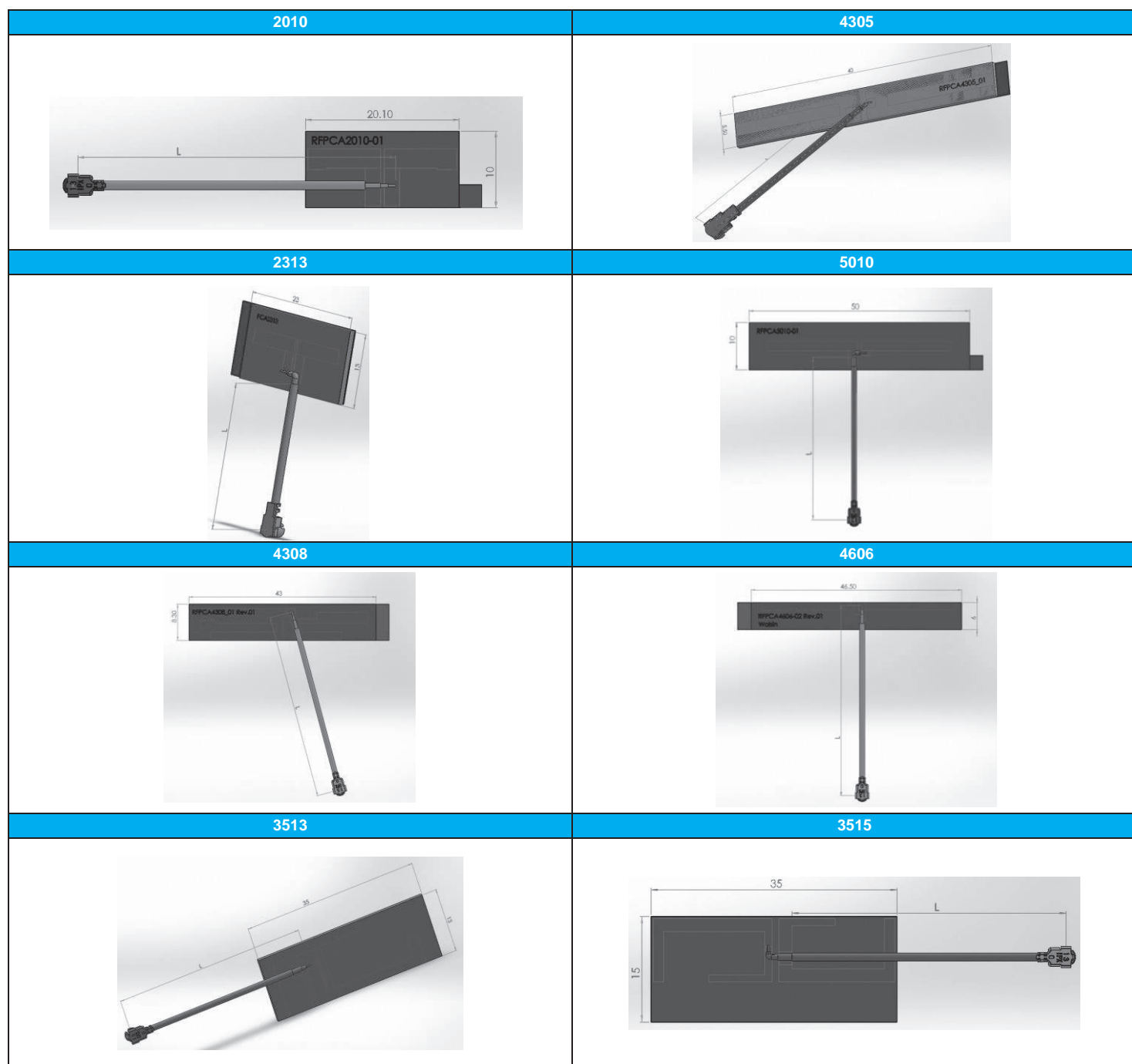

FPA Antenna

■ **ELECTRICAL SPECIFICATION**

Series	Size(mm)		Cable Length(mm) L	Working Frequency Range	Gain	VSWR	Return Loss
	L	w					
3025	30.3	25.3	Option	2.4~2.5 GHz	3dBi	<2	<-10dB
3225	25	32.6	Option	2.4~2.5 GHz	2dBi	<2	<-10dB
3226	32.35	26	Option	2.4~2.5 / 5.x GHz	3dBi	<2	<-10dB
4305	43	5.5	Option	2.4~2.5 GHz	3dBi	<2	<-10dB
3010	30	10	Option	2.4~2.5 GHz	2dBi	<2	<-10dB
2006	20	6	Option	5.x GHz	2dBi	<2	<-10dB

3025

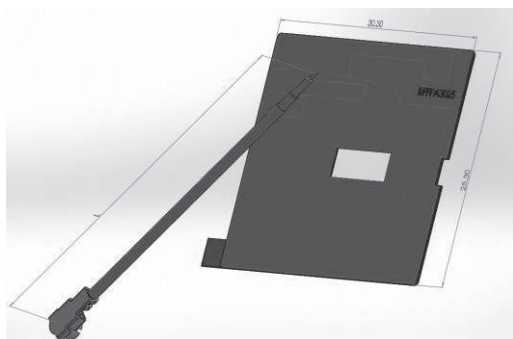

3225

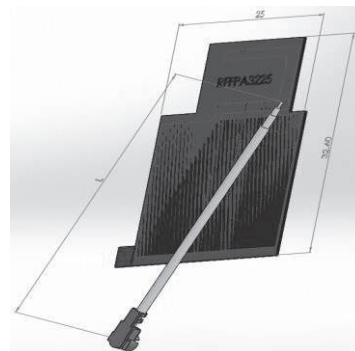

3226

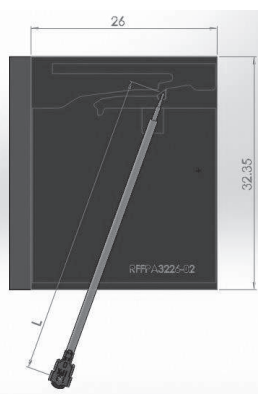

4305

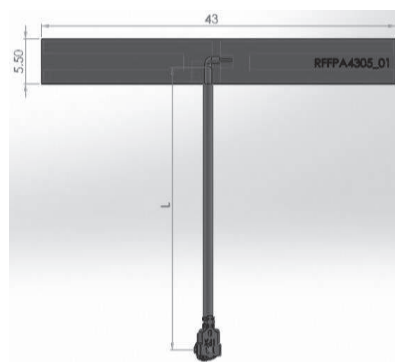

3010



2006

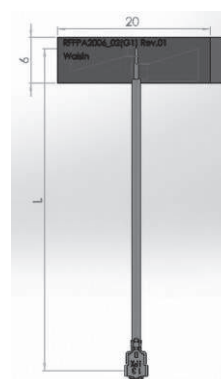

Metal Antenna

■ **ELECTRICAL SPECIFICATION**

Series	Size(mm)		Cable Length(mm) L	Working Frequency Range	Gain	VSWR	Return Loss
	L	w					
3109	31	9	Option	2.4~2.5/5.x GHz	2.4~2.5 GHz : 2 dBi 5.x GHz : 2 dBi	<2	<-10dB
2107	21.5	7.1	None	2.4~2.5 GHz	3 dBi	<2	<-10dB
2807	28.6	7.9	Option	2.4~2.5 GHz	3 dBi	<2	<-10dB
3407	34	7.5	Option	2.4~2.5 GHz	3 dBi	<2	<-10dB
3706	37.4	6.5	Option	2.4~2.5/5.x GHz	2.4~2.5 GHz : 5 dBi 5.x GHz : 5 dBi	<2	<-10dB
2712	27.75	12.8	None	2.4~2.5 GHz	3.38 dBi	<2	<-10dB
2811	27.05	11.3	None	2.4~2.5/5.x GHz	2.4~2.5 GHz : 2.66dBi 5.x GHz : 3.68dBi	<2	<-10dB
2911	29.6	11.3	None	2.4~2.5/5.x GHz	2.4~2.5 GHz : 2.14dBi 5.x GHz : 2.68dBi	<2	<-10dB

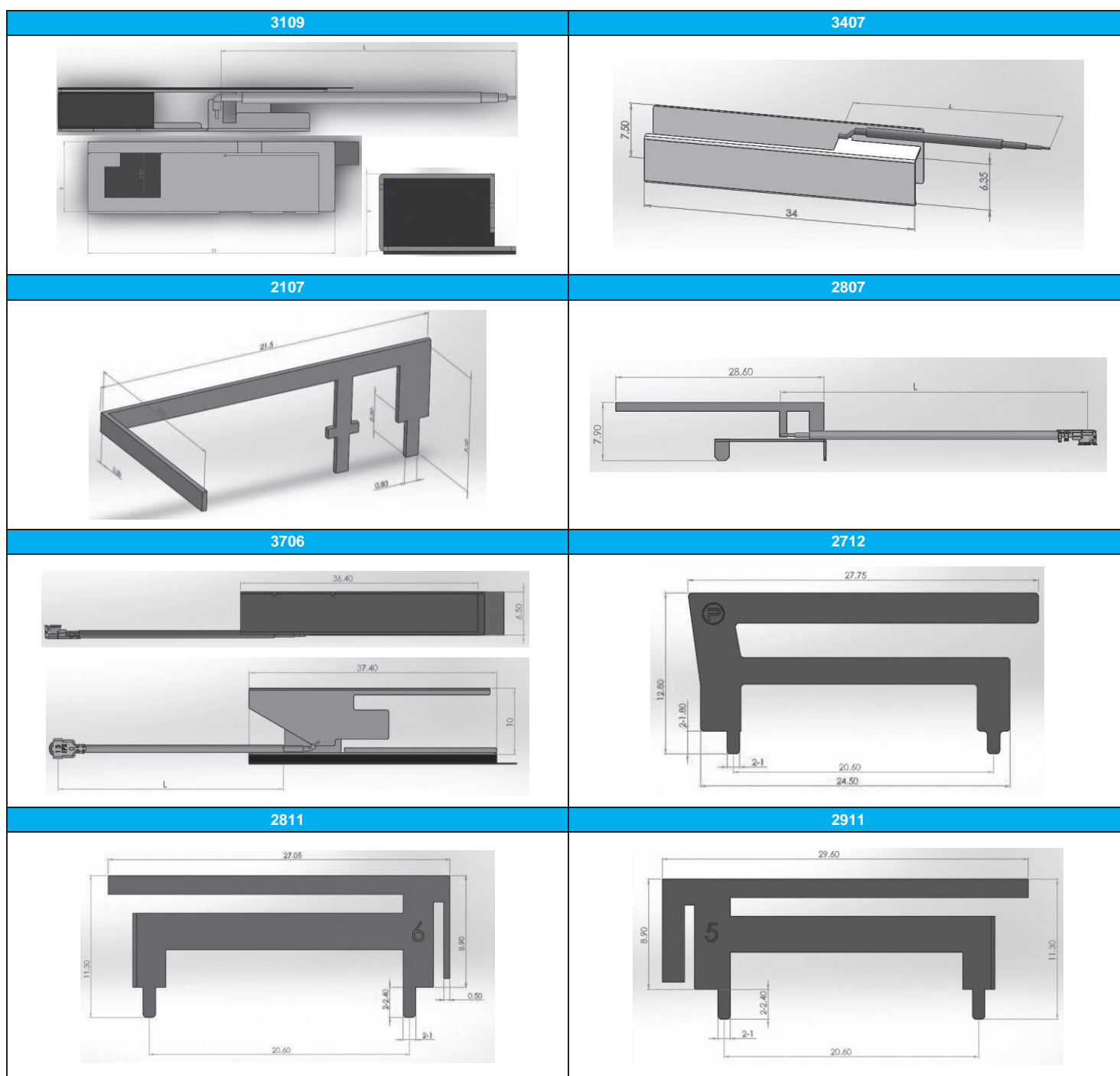

NFC Antenna (NFC/WPC/WNC)

■ **ELECTRICAL SPECIFICATION**

NFC

Series	Size(mm)		Ls	Rs	Q
	L	w			
5030	50	30	1.62±0.1μH	0.66±0.15Ω	15.42±2.5(1MHz)
5040	50	40	1.89±0.1μH	0.76±0.15Ω	15.62±2.5(1MHz)
6040	60	40	2.37±0.1μH	0.85±0.15Ω	17.5±2.5(1MHz)

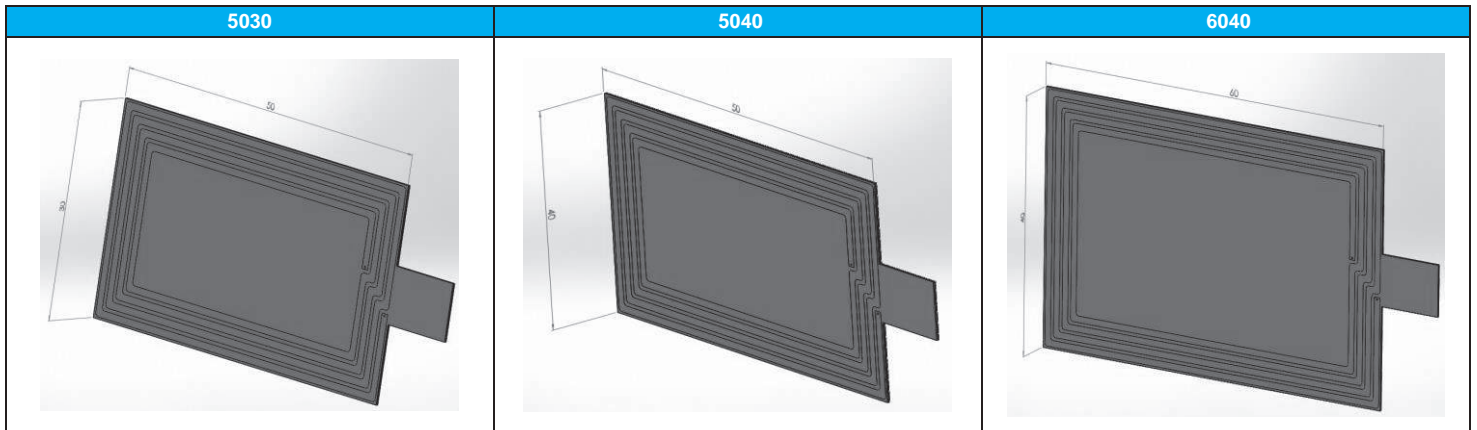

WPC & WNC

TYPE	Series	Size(mm)		Ls		Rs		Q	
		L	w	NFC	WPC	NFC	WPC	NFC	WPC
WPC	4832	48	32	1.35±0.1μH		0.3±0.15Ω		28.3±2.5(1MHz)	
WNC	6060	60	60	NFC	2.11±0.1μH	NFC	0.572±0.15Ω	NFC	37.2±2.5(1MHz)
				WPC	18.69±0.1μH	WPC	0.837±0.15Ω	WPC	14.03±2.5(1MHz)

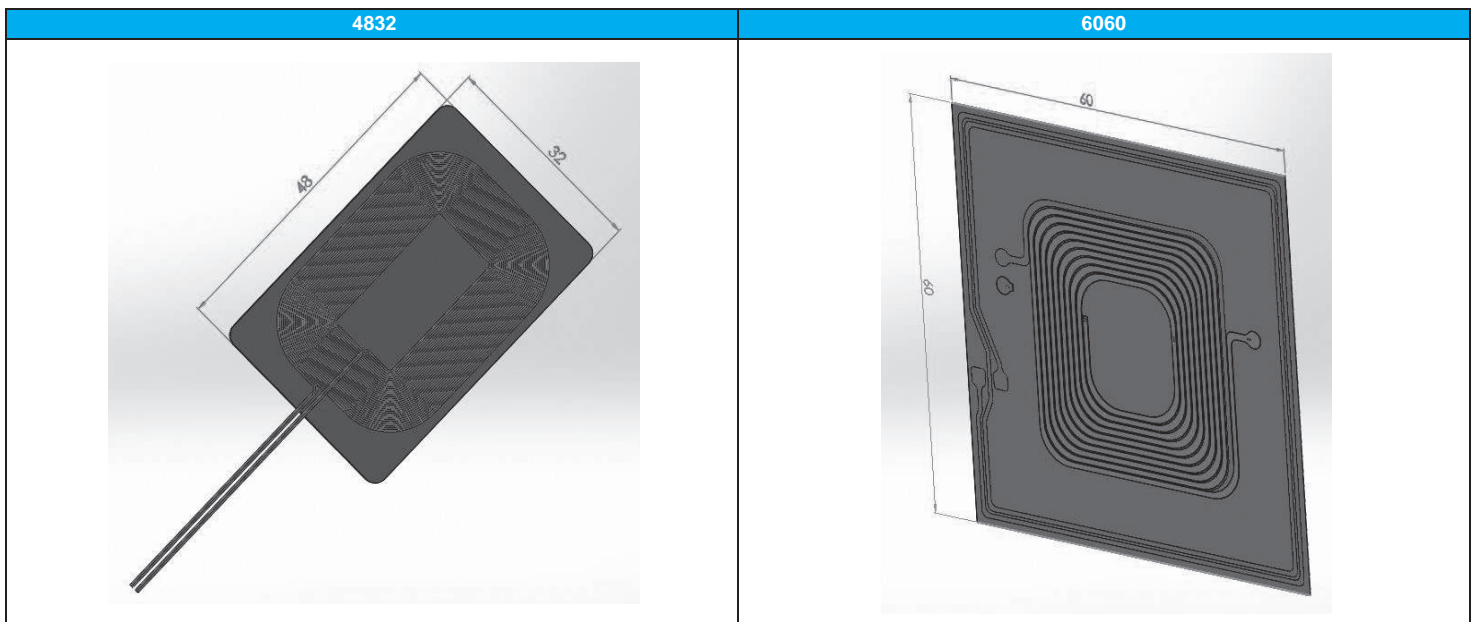

Connector

■ **ELECTRICAL SPECIFICATION**

Series	Size(mm)		Working Frequency Range	VSWR
	L	w		
1612	16.8	12.3	DC ~ 6 GHz	2.0
0703	7.5	3.3	DC ~ 6 GHz	2.0
1308	13.3	8	DC ~ 6 GHz	2.0

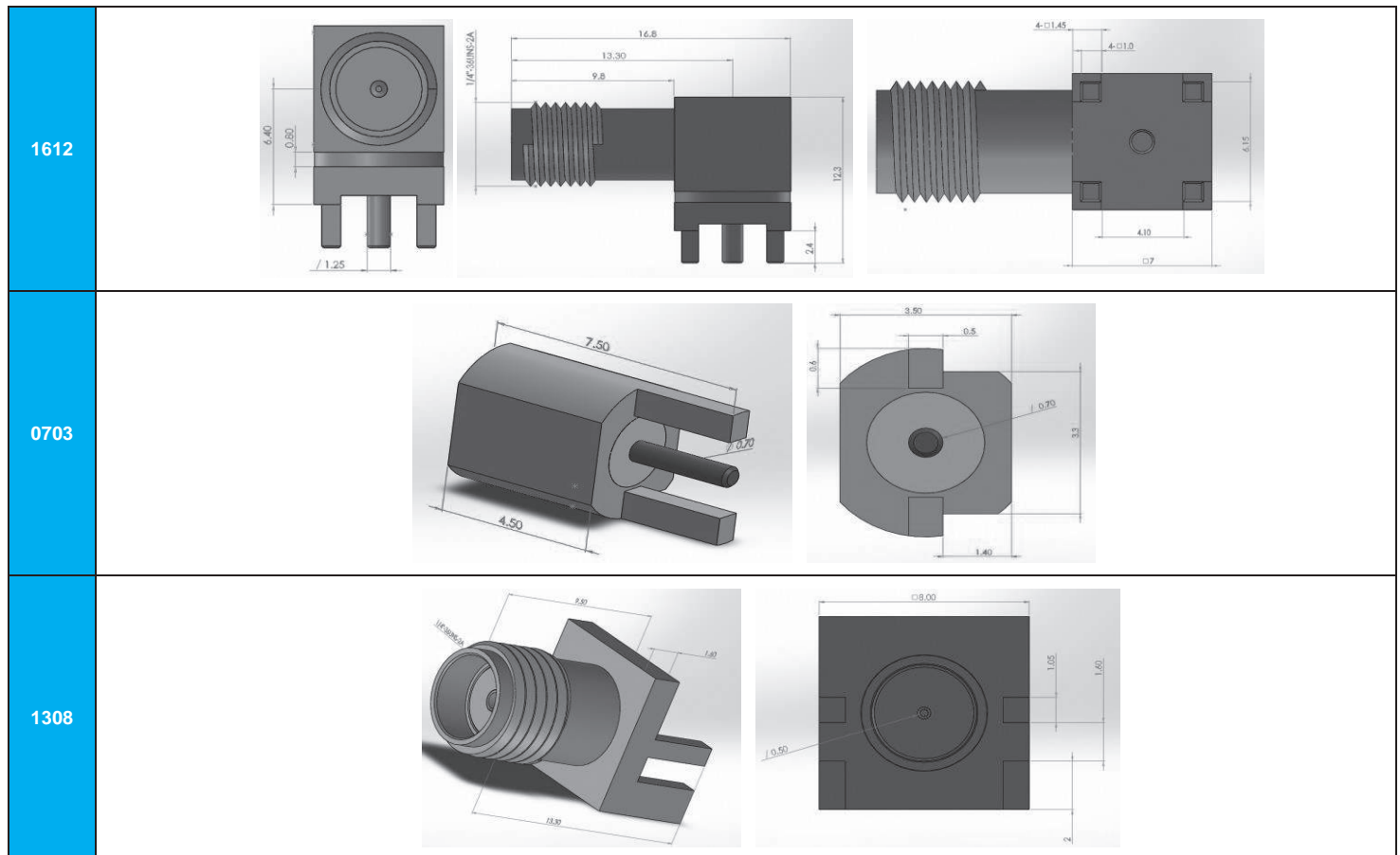

Measurement Equipment

- Antenna Passive Measurement : Efficiency / 3D Pattern @400MHz ~6GHz
- Active Measurement : TRP & TIS Measurement for GSM/WCDMA/TD-CDMA/TDD-LTE/FDD-LTE

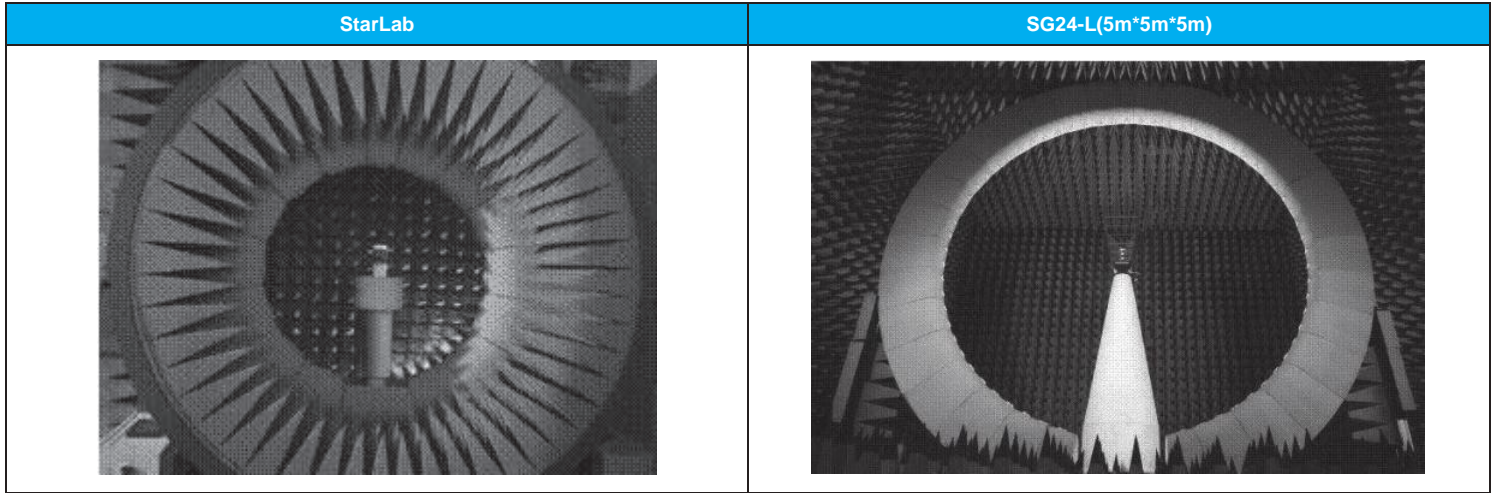

■ 2D Antenna Lab (Wireless Throughput Test)



■ 2D Antenna Lab (Smart TV Wireless Throughput Test)

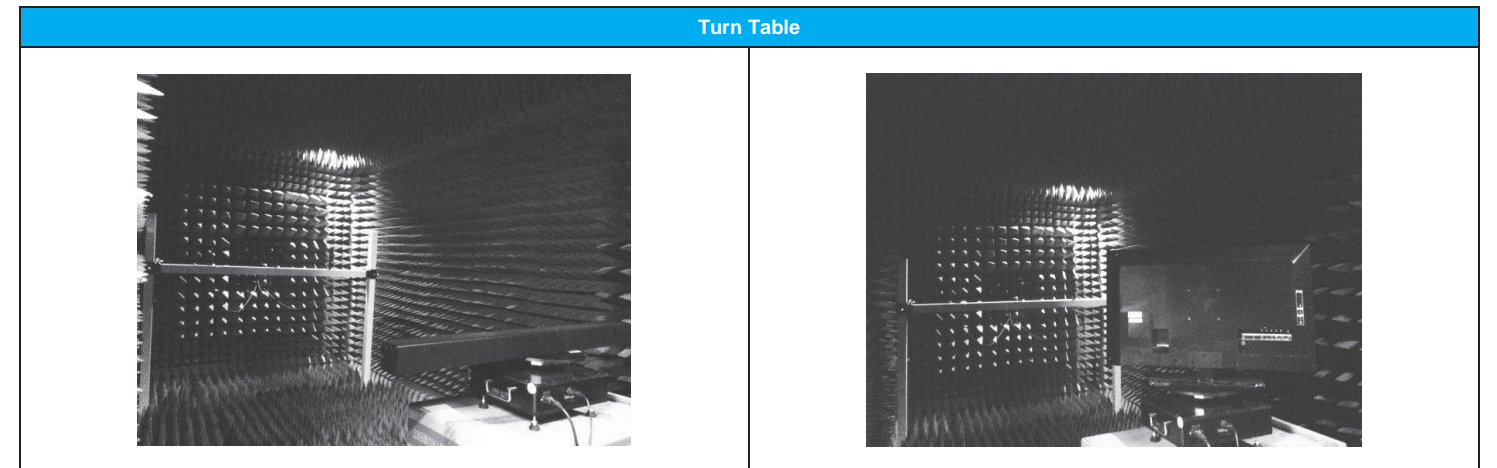

FIME EMVCo/ISO10373-6 / NFC Forum

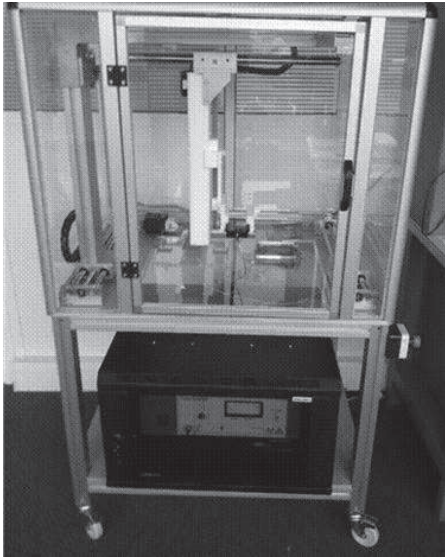

Comprion (NFC Forum)



Suzhou Smart TV Antenna Chamber

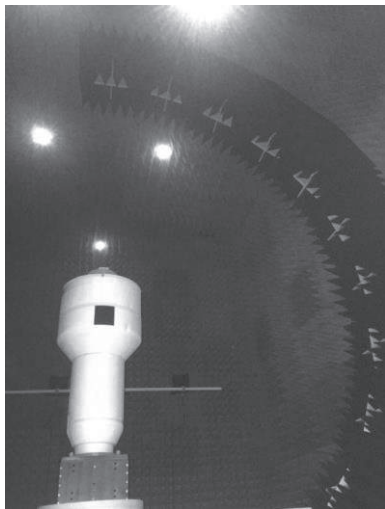

Shenzhen RayZone 1800

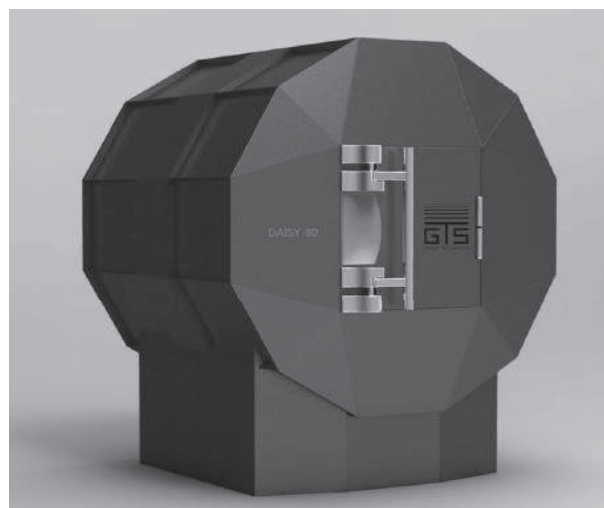

Taiwan - Yang-Mei Plant / Sales Office

Walsin Technology Corporation
566-1, Kao-Shi Road, Yang-Mei, Tao-Yuan, Taiwan
Tel: +886-3-475-8711 Fax: +886-3-475-7130 Email: info@passivecomponent.com

China - Dalang Plant / Sales Office

Dongguan Walsin Tech. Electronics CO., Ltd.
Xiniupo Administrative Zone, Dalang Town, Dongguan City, Guangdong Province 523799
Tel: +86-769-831-15168 Fax: +86-769-831-15188 Email: msyu@passivecomponent.com

China - Suzhou Plant / Sales Office

Suzhou Walsin Technology Electronics Co., Ltd.
No. 369, Changyan Street, Suzhou Industrial Park, Jiangsu Province 215126
Tel: +86-512-628-36888 Fax: +86-512-628-37888 Email: msyu@passivecomponent.com

China - Guangzhou Plant / Sales Office

Pan Overseas (Guangzhou) Electronic Co., Ltd.
No. 277, Hong Ming Road, Eastern Section, Guangzhou Economic and Technology, Development Zone, China
Tel: +86-20-8223-7476 Fax: +86-20-8223-7475 Email: msyu@passivecomponent.com

Germany - Munich Sales Office

Walsin Technology Corporation Europe
Stefan-George-Ring 2, 81929 München, Germany
Tel: +49-(0)89-9308-6475 Fax: +49-(0)89-9308-6464 Email: aw@passivecomponent.com

Singapore - Sales Office

WTC Singapore Sales Office, Singapore
24 Sin Ming Lane Midview City, #04-100, Singapore 573970
Contact: Morris Liew
Tel: +65-6262 3997 Email: [morisliew@sg.passivecomponent.com](mailto:morrisliew@sg.passivecomponent.com)

Malaysia - Sales Office

Walsin Technology Corporation, Malaysia
1st Floor, No.19, Jalan Puteri 5/8, Bandar Puteri Puchong, Puchong, 47100, Selangor, Malaysia
Contact: Arthur Ling
Tel: +6016-2217-948 Fax: +603-8051-7060 Email: arthurling@passivecomponent.com

United States - West Coast Sales Office

Walsin Technology Corporation, USA
Contact: FC Tseng
Tel: +1-214-708-5182 E-mail: fctseeng@passivecomponent.com

JAPAN - Sales Office

PSA BLDG. 3F, 6-1-6 Chuou, Yamato-Shi, Kanagawa, 242-0021 Japan
Tel: +81-46-204-8829 Fax: +81-46-204-8955 Email: tsakano@kamaya.co.jp

PSA PASSIVE SYSTEM ALLIANCE
WALSIN TECHNOLOGY CORPORATION

TAIWAN - WTC Yang-Mei Plant / Sales Office



Aug. 2018

Looking for pricing, stock, or lifecycle information?

Click below to explore more details on WIN SOURCE:

- ⊖ [View RFANT5220110A2T on WIN SOURCE](#)
- ⊖ [Walsin Technology Corporation Information](#)

Optimize Your Supply Chain with WIN SOURCE Solutions

- ✓ Global Sourcing Solution
- ✓ Obsolete Management
- ✓ Cost Control Management
- ✓ Shortage Management
- ✓ Alternative Solution
- ✓ Excess Inventory Management