



**THE DATASHEET OF  
RF3024TR7**





Package: SC70, 6-Pin



### Product Description

The RF3024 is a GaAs pHEMT single-pole double-throw (SPDT) switch designed for general purpose switching applications which require very low insertion loss, moderate isolation, and medium power handling capability. The RF3024 is ideally suited for battery-powered and low control voltage applications.

#### Optimum Technology Matching® Applied

- GaAs HBT
- GaAs MESFET
- InGaP HBT
- SiGe BiCMOS
- Si BiCMOS
- SiGe HBT
- GaAs pHEMT
- Si CMOS
- Si BJT
- GaN HEMT
- InP HBT
- RF MEMS
- LDMOS

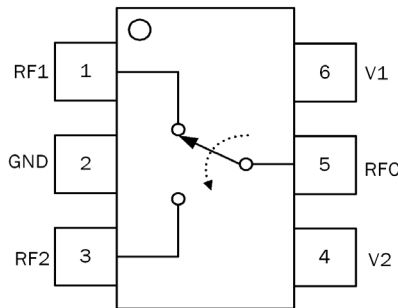

### Features

- 10MHz to 4GHz Operation
- 0.25dB Insertion Loss at 1GHz
- 26dB Isolation at 2GHz
- 1.8V Minimum Control Voltage
- 28dBm P0.1dB at 3V
- 18dBm P0.1dB at 1.8V
- 58dBm IP3 at 3V

### Applications

- Cellular Handset Applications
- Antenna Tuning Applications
- IEEE 802.11b/g WiFi Applications
- Cellular Infrastructure Applications

Parameter	Specification			Unit	Condition
	Min.	Typ.	Max.		
Insertion Loss		0.25		dB	1GHz
		0.3	0.4	dB	2GHz
		0.45		dB	3GHz
VSWR		1.15			1GHz
		1.2			2GHz
		1.33			3GHz
Isolation		26		dB	1GHz
	22	26		dB	2GHz
		27		dB	3GHz
P1dB*		31		dBm	1GHz
		32		dBm	2GHz
P0.1dB*		28		dBm	1GHz
IP3*		60		dBm	1GHz, 1MHz Spacing, 15dBm per tone
		58		dBm	2GHz, 1MHz Spacing, 15dBm per tone
T <sub>ON</sub> , T <sub>OFF</sub>		40		nS	50% of V <sub>CTRL</sub> to 10/90% of RF
T <sub>RISE</sub> , T <sub>FALL</sub>		30		nS	10/90% RF

Test Conditions: 3.0V, 50Ω, 25°C, with Application Circuit shown herein.

\*Note: Performance degrades below 50MHz..

## Absolute Maximum Ratings

Parameter	Rating	Unit
Control Voltage	7.0	V
Maximum Input Power	+36	dBm
Operating Temperature	-40 to +85	°C
Storage Temperature	-65 to +150	°C
ESD Rating (HBM)	Class 1A	
MSL Rating	1	



Caution! ESD sensitive device.

Exceeding any one or a combination of the Absolute Maximum Rating conditions may cause permanent damage to the device. Extended application of Absolute Maximum Rating conditions to the device may reduce device reliability. Specified typical performance or functional operation of the device under Absolute Maximum Rating conditions is not implied.

The information in this publication is believed to be accurate and reliable. However, no responsibility is assumed by RF Micro Devices, Inc. ("RFMD") for its use, nor for any infringement of patents, or other rights of third parties, resulting from its use. No license is granted by implication or otherwise under any patent or patent rights of RFMD. RFMD reserves the right to change component circuitry, recommended application circuitry and specifications at any time without prior notice.



RFMD Green: RoHS compliant per EU Directive 2002/95/EC, halogen free per IEC 61249-2-21, < 1000 ppm each of antimony trioxide in polymeric materials and red phosphorus as a flame retardant, and <2% antimony in solder.

## Switch Control Settings

	Control Signals		Signal Paths	
	V1	V2	RFC-RF1	RFC-RF2
Valid States	1	0	ON	OFF
	0	1	OFF	ON
Invalid States	0	0	Indeterminate State*	
	1	1	Indeterminate State*	

0: Logic level low, 0V ~ 0.2V

1: Logic level high, 1.8V ~ 5.0V

\*In indeterminate states, both signal paths are in high insertion loss states, ~10dB.

## Evaluation Board Schematic

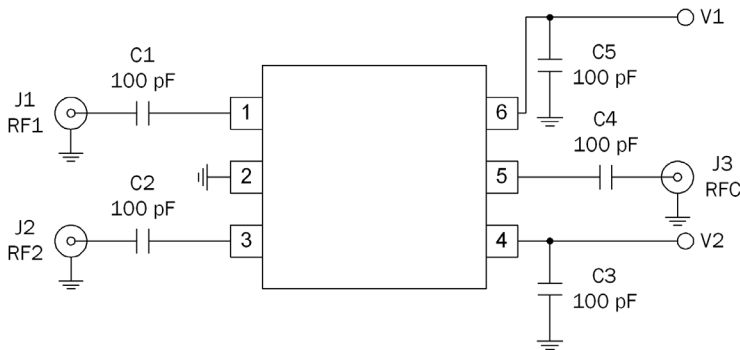

## Pin Names and Descriptions

Pin	Name	Description
1	RF1	RF Port 1.
2	GND	Ground.
3	RF2	RF Port 2.
4	V2	RF2 Control Voltage.
5	RFC	Common RF Port.
6	V1	RF1 Control Voltage.

## Package Drawing

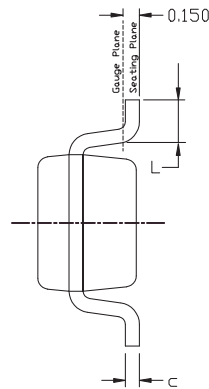
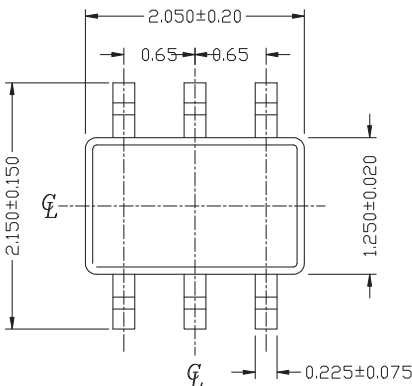

SYMBOL	MIN	MAX
E	1.15	1.35
D	1.85	2.25
HE	2.00	2.30
A	0.80	1.00
A2	0.80	0.91
A1	0.00	0.09
e	0.65 BSC	
b	0.15	0.30
c	0.08	0.25
L	0.21	0.41

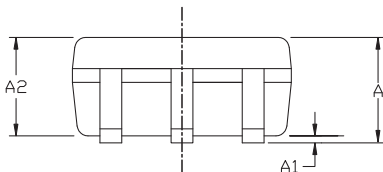

### NOTE:

1. ALL DIMENSIONS ARE IN MILLIMETERS.
2. DIMENSIONS ARE EXCLUSIVE OF MOLD FLASH & GATE BURR.
3. ALL SPECIFICATIONS COMPLY TO JEDEC SPEC MO-203 ISSUE A.
4. DIE IS FACING UP FOR MOLD AND FACING DOWN FOR TRIM/FORM. ie :REVERSE TRIM/FORM.
5. PACKAGE SURFACE MATTE FINISH VDI 11~13.
6. THE FOOT LENGTH MEASURING BASED ON GAUGE PLANE METHOD.

## Typical Performance

Temp = 25 °C,  $V_{\text{CONTROL}} = 3.0\text{V}$

Note: Low Frequency RL performance can be improved using larger DC blocking capacitors

Insertion Loss versus Frequency

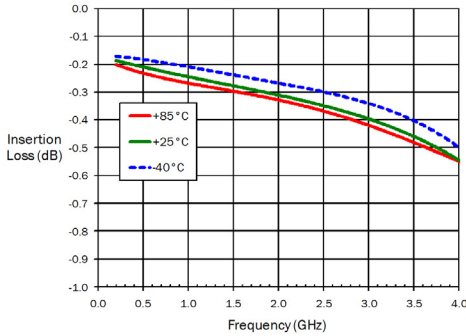

Isolation versus Frequency

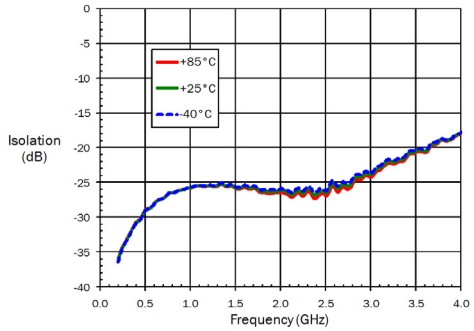

Return Loss versus Frequency

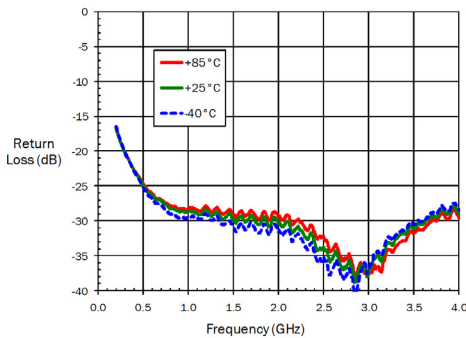

IP3 versus Frequency (15 dBm tones, 3V)

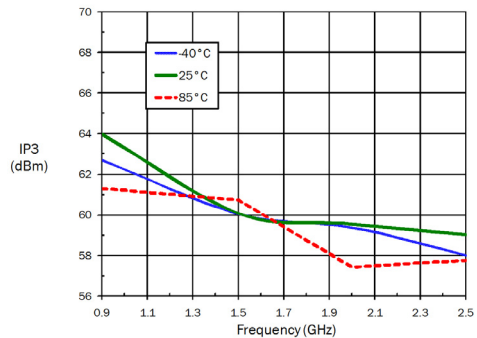

Input P1dB Compression Point versus Control Voltage (915MHz)

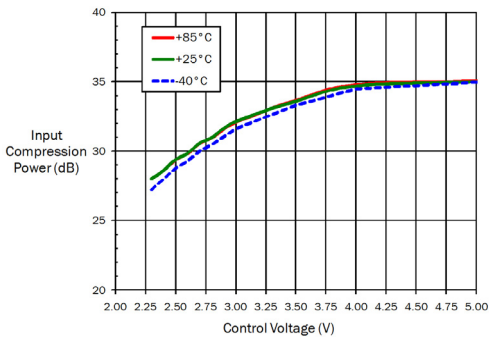

Input P1dB Compression Point versus Control Voltage (1980MHz)

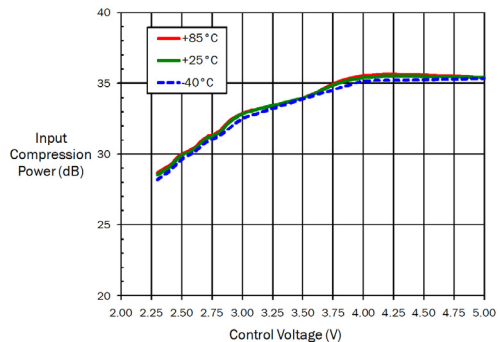



## Ordering Information







Ordering Code	Description
RF3024	Sample bag with 25 pieces
RF3024SR	7" Reel with 100 pieces
RF3024TR7	7" Reel with 2500 pieces
RF3024PCK-410	500MHz PCBA with 5-piece sample bag

## Looking for pricing, stock, or lifecycle information?

Click below to explore more details on WIN SOURCE:

-  [View RF3024TR7 on WIN SOURCE](#)
-  [RF Micro Devices Information](#)

## Optimize Your Supply Chain with WIN SOURCE Solutions

-  Global Sourcing Solution
-  Obsolete Management
-  Cost Control Management
-  Shortage Management
-  Alternative Solution
-  Excess Inventory Management