



**THE DATASHEET OF
RF2436TR7**





Package Style: SOT-5



Features

- Single Positive Power Supply
- Low Current Consumption
- 1dB Insertion Loss at 900MHz
- 24 dB Crosstalk Isolation at 900MHz
- +27 dBm Output P1dB

Applications

- Cordless Phones
- Wireless Computer Peripherals
- Wireless Security Systems
- General Purpose RF Switching
- Commercial and Consumer Systems

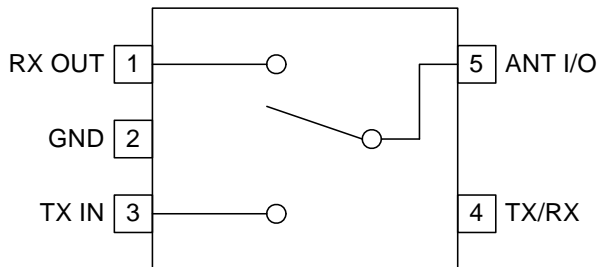

Functional Block Diagram

Product Description

The RF2436 is a very low-cost transmit/receive GaAs MESFET switch. The device can handle power levels as high as +28dBm and spans a frequency range from DC to 2500MHz. The switch will operate from power supply voltages as low as 1.5V and as high as 6V with a CMOS logic driver for the control input. No negative voltage is required, and current consumption is very low. VSWR for the active channel (transmit or receive) is 1.1:1. The device is housed in a very small industry-standard SOT 5-lead plastic package.

Ordering Information

RF2436 Transmit/Receive Switch
 RF2436PCBA-41X Fully Assembled Evaluation Board

Optimum Technology Matching® Applied

- | | | | |
|---|--------------------------------------|-------------------------------------|-----------------------------------|
| <input type="checkbox"/> GaAs HBT | <input type="checkbox"/> SiGe BiCMOS | <input type="checkbox"/> GaAs pHEMT | <input type="checkbox"/> GaN HEMT |
| <input checked="" type="checkbox"/> GaAs MESFET | <input type="checkbox"/> Si BiCMOS | <input type="checkbox"/> Si CMOS | <input type="checkbox"/> RF MEMS |
| <input type="checkbox"/> InGaP HBT | <input type="checkbox"/> SiGe HBT | <input type="checkbox"/> Si BJT | <input type="checkbox"/> LDMOS |

RF MICRO DEVICES®, RFMD®, Optimum Technology Matching®, Enabling Wireless Connectivity™, PowerStar®, POLARIS™ TOTAL RADIO™ and UltimateBlue™ are trademarks of RFMD, LLC. BLUETOOTH is a trademark owned by Bluetooth SIG, Inc., U.S.A. and licensed for use by RFMD. All other trade names, trademarks and registered trademarks are the property of their respective owners. ©2012, RF Micro Devices, Inc.

Absolute Maximum Ratings

Parameter	Rating	Unit
Supply Voltage	0 to +8.0	V _{DC}
Control Voltage	-1.0 to +6.0	V
Input RF Power	+30	dBm
Operating Ambient Temperature	-40 to +85	°C
Storage Temperature	-40 to +150	°C



Caution! ESD sensitive device.

Exceeding any one or a combination of the Absolute Maximum Rating conditions may cause permanent damage to the device. Extended application of Absolute Maximum Rating conditions to the device may reduce device reliability. Specified typical performance or functional operation of the device under Absolute Maximum Rating conditions is not implied.

The information in this publication is believed to be accurate and reliable. However, no responsibility is assumed by RF Micro Devices, Inc. ("RFMD") for its use, nor for any infringement of patents, or other rights of third parties, resulting from its use. No license is granted by implication or otherwise under any patent or patent rights of RFMD. RFMD reserves the right to change component circuitry, recommended application circuitry and specifications at any time without prior notice.



RFMD Green: RoHS compliant per EU Directive 2002/95/EC, halogen free per IEC 61249-2-21, < 1000ppm each of antimony trioxide in polymeric materials and red phosphorus as a flame retardant, and <2% antimony in solder.

Parameter	Specification			Unit	Condition
	Min.	Typ.	Max.		
Overall					T=25 °C, V _{DD} =3.0V, Freq=900MHz
Frequency Range		DC to 2500		MHz	
Insertion Loss		1	2	dB	Transmit or receive mode.
Isolation	20	22		dB	Receive mode; ANT I/O to TX IN crosstalk
	20	24		dB	Transmit mode; ANT I/O to RXOUT crosstalk
RX OUT VSWR		1.1:1			Receive mode.
TX IN VSWR		1.1:1			Transmit mode.
Output P1dB		+27		dBm	
Output IP3		+39		dBm	
Switching Speeds:					
RX OUT T _{ON} , T _{OFF}		12		ns	50% of V _{CTRL} to 10/90% of RF
RX OUT T _{RISE} , T _{FALL}		8		ns	10/90% RF
TX IN T _{ON} , T _{OFF}		11		ns	50% of V _{CTRL} to 10/90% of RF
TX IN T _{RISE} , T _{FALL}		7		ns	10/90% RF
Control Logic					
CTRL Logic "Low" Voltage		0		V	Receive mode.
CTRL Logic "High" Voltage		0.7		V	Transmit mode.
Power Supply					
Voltage		3		V	Specifications
		1.5 to 6		V	Operating Limits
Current		5	10	µA	Receive mode.
		0.5	1	mA	Transmit mode.

Pin	Function	Description	Interface Schematic
1	RX OUT	Output pin for Receive mode. VSWR is 1.1:1 when Receive mode is selected and highly capacitive when Transmit mode is selected.	
2	GND	Ground connection. For best performance, keep traces physically short and connect immediately to the ground plane.	
3	TX IN	Input pin for Transmit mode. The input VSWR is 1.1:1 when Transmit mode is selected and highly capacitive when Receive mode is selected.	
4	TX/RX	Transmit Mode/Receive Mode control pin. A "low" level chooses Receive mode; a "high" level chooses Transmit mode. CMOS logic may be used to drive the control input.	
5	ANT I/O	Input/Output pin from/to antenna and power supply pin. This pin must be biased with VDD through a resistor.	

Package Drawing

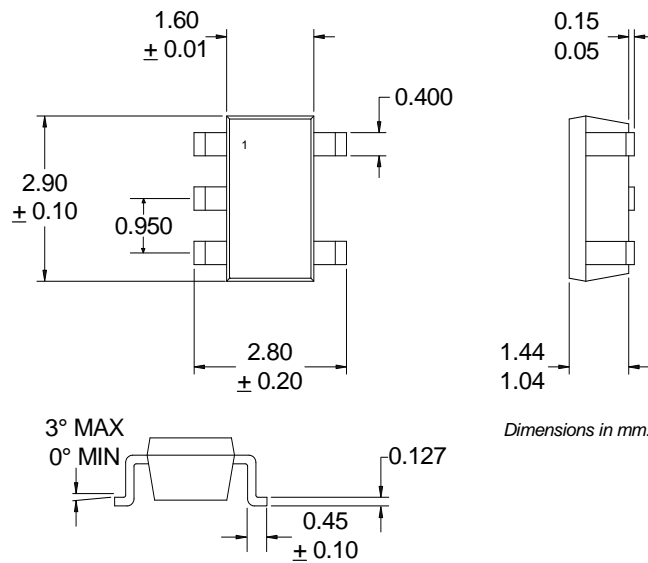

Evaluation Board Schematic

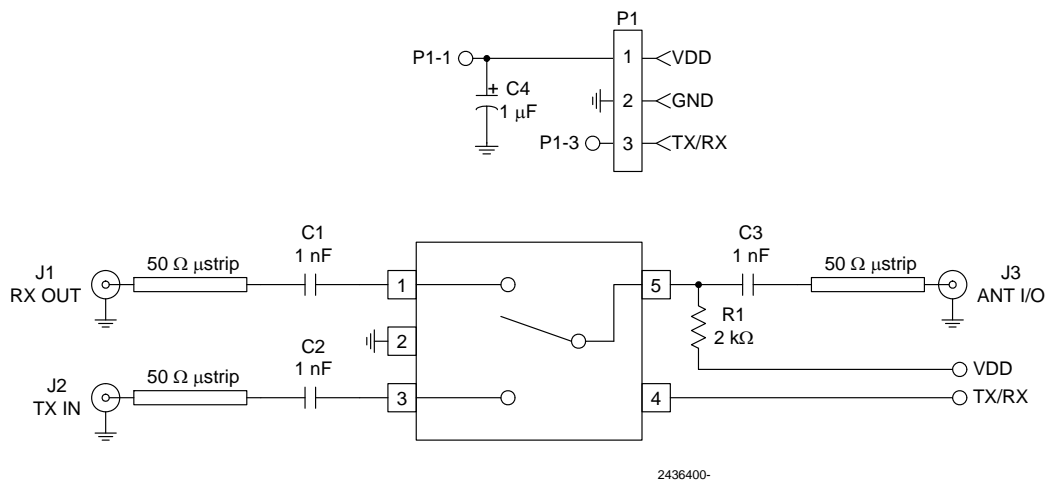

Evaluation Board Layout

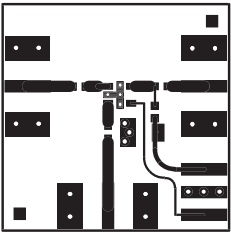
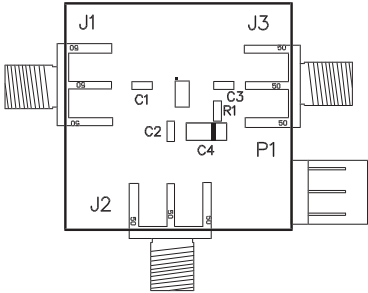

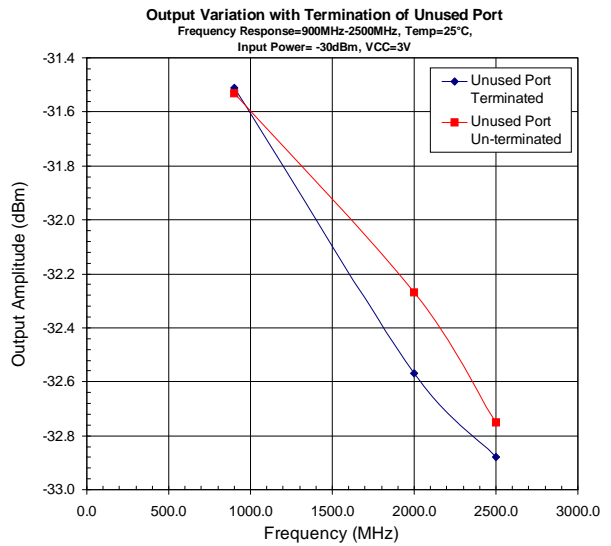
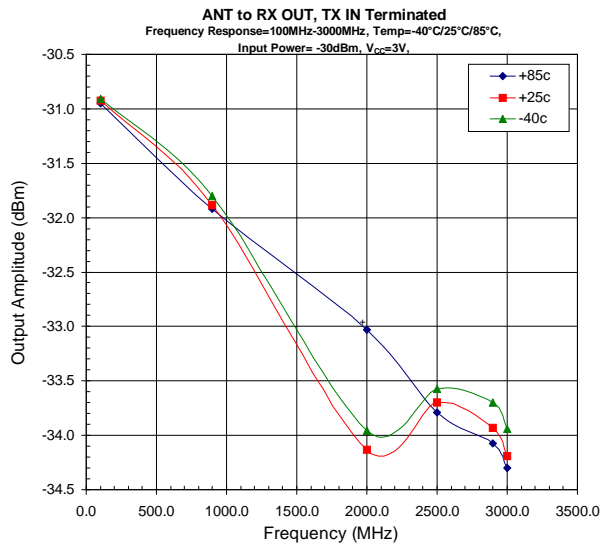

RoHS* Banned Material Content

RoHS Compliant: Yes
 Package total weight in grams (g): 0.008
 Compliance Date Code: 518
 Bill of Materials Revision: -
 Pb Free Category: e3

Bill of Materials	Parts Per Million (PPM)					
	Pb	Cd	Hg	Cr VI	PBB	PBDE
Die	0	0	0	0	0	0
Molding Compound	0	0	0	0	0	0
Lead Frame	0	0	0	0	0	0
Die Attach Epoxy	0	0	0	0	0	0
Wire	0	0	0	0	0	0
Solder Plating	0	0	0	0	0	0

This RoHS banned material content declaration was prepared solely on information, including analytical data, provided to RFMD by its suppliers, and applies to the Bill of Materials (BOM) revision noted above.

* DIRECTIVE 2002/95/EC OF THE EUROPEAN PARLIAMENT AND OF THE COUNCIL of 27 January 2003 on the restriction of the use of certain hazardous substances in electrical and electronic equipment

Looking for pricing, stock, or lifecycle information?

Click below to explore more details on WIN SOURCE:

-  [View RF2436TR7 on WIN SOURCE](#)
-  [RF Micro Devices Information](#)

Optimize Your Supply Chain with WIN SOURCE Solutions

-  Global Sourcing Solution
-  Obsolete Management
-  Cost Control Management
-  Shortage Management
-  Alternative Solution
-  Excess Inventory Management