



**THE DATASHEET OF
RF1126TR7**



Package Style: QFN, 6-pin, 2mmx1.3mmx0.35mm



Features

- Broadband Performance
Low Frequency to 5.8GHz
- Very Low Insertion Loss
0.26dB Typ at 1GHz
0.32dB Typ at 2GHz
- Excellent Harmonics <-75 dBc
at 2GHz
- High IIP₃: Cell Band Typ.
62dBm
- 1.8V Capable for Low Power
Applications
- PO.1dB > 23dBm Typ @ 2GHz

Applications

- Cellular Handset Applications
- Antenna Tuning Applications
- IEEE802.11b/g WLAN Applications
- Multi-mode GSM, W-CDMA Applications
- WLAN Applications

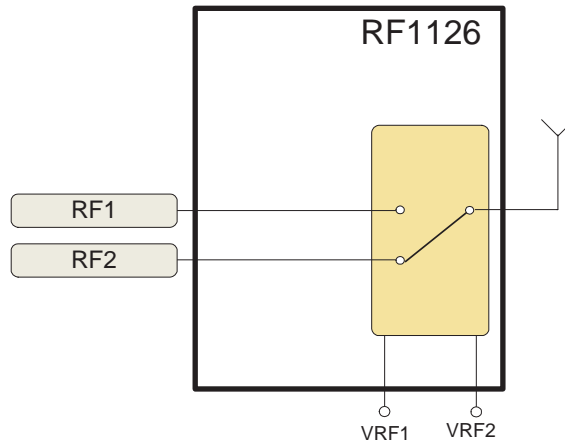

Functional Block Diagram

Product Description

The RF1126 is a single-pole double-throw (SPDT) switch designed for general purpose switching applications which require very low insertion loss and medium power handling capability. The RF1126 is ideally suited for battery operated applications requiring high performance switching with very low DC power consumption. The RF1126 features low insertion loss, high linearity, and very good harmonic characteristics, and is operable from 1.8V to 3.6V control voltage. It is fabricated with 0.5µm GaAs pHEMT process, and is packaged in a very compact 2mmx1.3mm, 6-pin, leadless QFN package.

Ordering Information

RF1126 Broadband Medium Power SPDT Switch
RF1126PCBA-410 Fully Assembled Evaluation Board

Optimum Technology Matching® Applied

- | | | | |
|--------------------------------------|--------------------------------------|--|-----------------------------------|
| <input type="checkbox"/> GaAs HBT | <input type="checkbox"/> SiGe BiCMOS | <input checked="" type="checkbox"/> GaAs pHEMT | <input type="checkbox"/> GaN HEMT |
| <input type="checkbox"/> GaAs MESFET | <input type="checkbox"/> Si BiCMOS | <input type="checkbox"/> Si CMOS | |
| <input type="checkbox"/> InGaP HBT | <input type="checkbox"/> SiGe HBT | <input type="checkbox"/> Si BJT | |

RF MICRO DEVICES®, RFMD®, Optimum Technology Matching®, Enabling Wireless Connectivity™, PowerStar®, POLARIS™ TOTAL RADIO™ and UltimateBlue™ are trademarks of RFMD, LLC. BLUETOOTH is a trademark owned by Bluetooth SIG, Inc., U.S.A. and licensed for use by RFMD. All other trade names, trademarks and registered trademarks are the property of their respective owners. ©2006, RF Micro Devices, Inc.

RF1126



rfmd.com

Absolute Maximum Ratings

Parameter	Rating	Unit
Voltage	6.0	V
Maximum Input Power (0.6GHz to 2.5GHz), RF1, RF2	+28	dBm
Operating Temperature	-30 to +85	°C
Storage Temperature	-65 to +100	°C



Caution! ESD sensitive device.

Exceeding any one or a combination of the Absolute Maximum Rating conditions may cause permanent damage to the device. Extended application of Absolute Maximum Rating conditions to the device may reduce device reliability. Specified typical performance or functional operation of the device under Absolute Maximum Rating conditions is not implied.

The information in this publication is believed to be accurate and reliable. However, no responsibility is assumed by RF Micro Devices, Inc. ("RFMD") for its use, nor for any infringement of patents, or other rights of third parties, resulting from its use. No license is granted by implication or otherwise under any patent or patent rights of RFMD. RFMD reserves the right to change component circuitry, recommended application circuitry and specifications at any time without prior notice.



RFMD Green: RoHS compliant per EU Directive 2002/95/EC, halogen free per IEC 61249-2-21, < 1000ppm each of antimony trioxide in polymeric materials and red phosphorus as a flame retardant, and <2% antimony in solder.

Parameter	Specification			Unit	Condition
	Min.	Typ.	Max.		
Overall - $V_{\text{control_high}} = 3\text{V}$					VRF1, VRF2 = High = 3 V, VRF1 = VRF2 = Low = 0 V, Temp = 25 °C
Operating Frequency	50		5800	MHz	
Insertion Loss					
RFC - RF1, RFC - RF2		0.21	0.24	dB	RF ON, 50MHz to 450MHz
		0.26	0.31	dB	RF ON, 824MHz to 960MHz
		0.32	0.40	dB	RF ON, 1850MHz to 1990MHz
		0.36	0.45	dB	RF ON, 2170MHz to 2500MHz
		0.70		dB	RF ON, 5.8GHz
Isolation					
RFC - RF1, RFC - RF2	31	33		dB	RF ON, 450MHz
	25	27		dB	RF ON, 824MHz to 960MHz
	18	20		dB	RF ON, 1850MHz to 1990MHz
	16	19		dB	RF ON, 2170MHz to 2500MHz
		11		dB	RF ON, 5.8GHz
Return Loss	19	26		dB	500MHz to 3000MHz
Second Harmonic		75		dBc	$P_{\text{IN}} = +15\text{dBm}$, 1980MHz
		69		dBc	$P_{\text{IN}} = +15\text{dBm}$, 2500MHz
Third Harmonic		90		dBc	$P_{\text{IN}} = +15\text{dBm}$, 1980MHz
		70		dBc	$P_{\text{IN}} = +15\text{dBm}$, 2500MHz
IIP3					
RF1 - RFC, RF2 - RFC (Cell)	61	62		dBm	Tone 1: 836.5MHz @ 16dBm, Tone 2: 791.5MHz @ -20dBm RX Freq: 881.5MHz
RF1 - RFC, RF2 - RFC (IMT)	59	60		dBm	Tone 1: 1950MHz @ 16dBm, Tone 2: 1760MHz @ -20dBm RX Freq: 2140MHz
Triple Beat Ratio					
Cell/AWS/PCS		61		dBc	VSWR=2:1
0.1 dB Compression (PO.1dB)	21	23		dBm	500MHz to 3000MHz
Switching Speed		160	400	ns	50% control to 10%/90%
Control Current		0.4	1.0	μA	$P_{\text{IN}} = 15\text{dBm}$

Parameter	Specification			Unit	Condition
	Min.	Typ.	Max.		
Overall - $V_{\text{control_high}} = 1.8\text{V}$					$V_{\text{RF1}}, V_{\text{RF2}} = \text{High} = 1.8\text{V}, V_{\text{RF1}} = V_{\text{RF2}} = \text{Low} = 0\text{V}, \text{Temp} = 25^\circ\text{C}$
Operating Frequency	50		5800	MHz	
Insertion Loss					
RFC - RF1, RFC - RF2		0.21	0.30	dB	RF ON, 450MHz
		0.26	0.35	dB	RF ON, 824MHz to 960MHz
		0.32	0.45	dB	RF ON, 1850MHz to 1990MHz
		0.36	0.50	dB	RF ON, 2170MHz to 2500MHz
		0.70		dB	RF ON, 5.8GHz
Isolation					
RFC - RF1, RFC - RF2	30	32		dB	RF ON, 450MHz
	24	25		dB	RF ON, 824MHz to 960MHz
	17	19		dB	RF ON, 1850MHz to 1990MHz
	15	18		dB	RF ON, 2170MHz to 2500MHz
		11		dB	RF ON, 5.8GHz
Return Loss	19	26		dB	500MHz to 3000MHz
0.1 dB Compression (P0.1dB)	7	11		dBm	500MHz to 3000MHz
Switching Speed		160	400	ns	50% control to 10%/90%
DC Supply	1.8	3.0	3.6	V	VRF1 and VRF2 (H)
	0		0.4	V	VRF1 and VRF2 (L)
Control Current		0.4	1.0	μA	$P_{\text{IN}} = 15\text{dBm}$

Control Logic

	Control Signals		Signal Paths	
	VRF1	VRF2	RF1-RFC	RF2-RFC
Valid States	1	0	ON	OFF
	0	1	OFF	ON
Invalid States	0	0	Indeterminate State*	
	1	1	Indeterminate State*	

0: Logic level low, 0V~0.4V

1: Logic level high, 1.8V~3.6V

Note: In indeterminate states, both signal paths are ON with degraded performance.

RF1126



rfmd.com

Pin	Function	Description
1	RF1	RF Port 1.
2	GND	Ground.
3	RF2	RF Port 2.
4	VRF2	Control 2.
5	RFC	Antenna.
6	VRF1	Control 1.
Pkg Base	GND	Ground.

Package Drawing

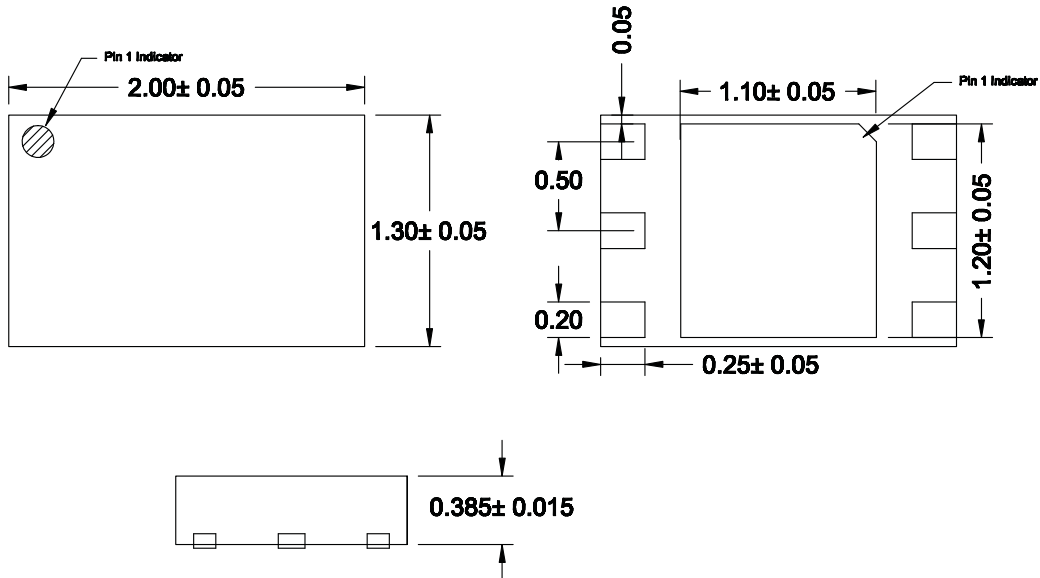

1) PIN 1 INDICATOR SHADED AREA
Notes:

Evaluation Board Schematic

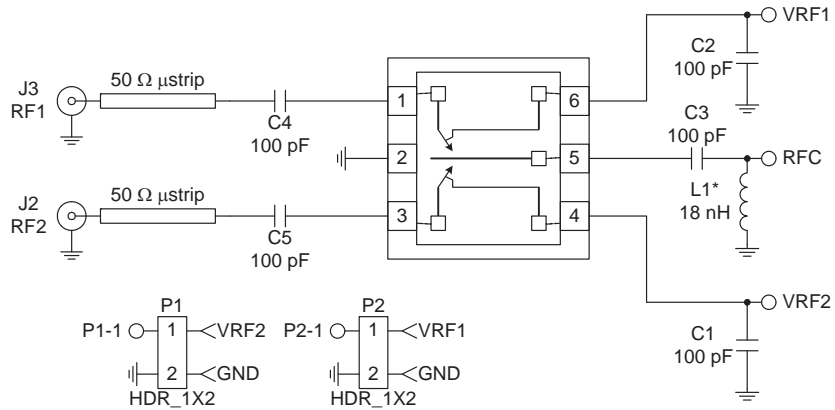

*L1 is optional for IEC61000-4-2 ESD protection.

Evaluation Board Layout
Board Thickness 0.067", Board Material FR-4, Multi-layer

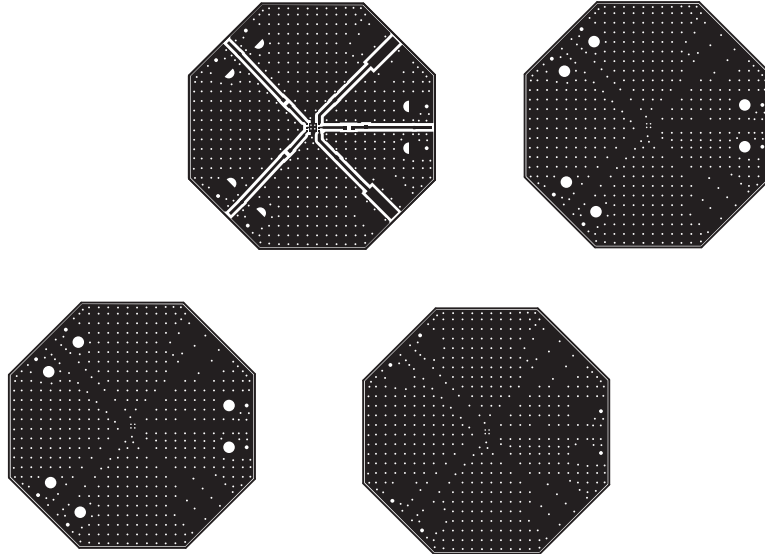

Typical Performance Data on Evaluation Board Note: Fixture losses have been de-embedded (Temp=25 °C, VRF1=VRF2=High=3V VRF1=VRF2=Low=0V)

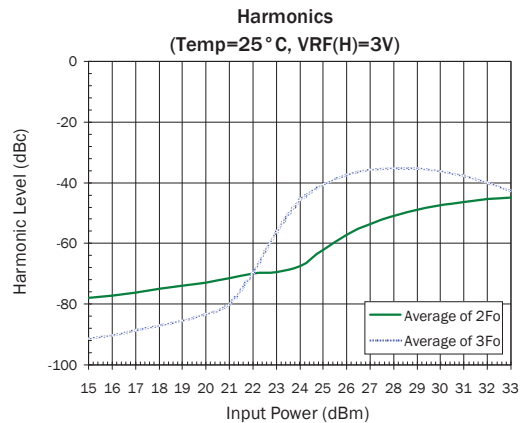
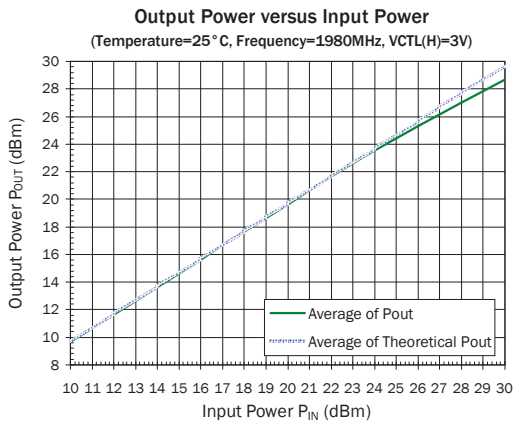
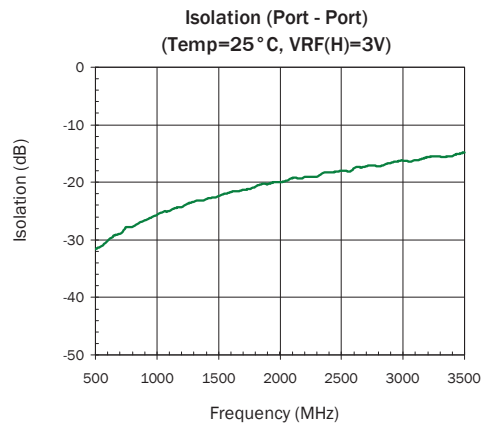
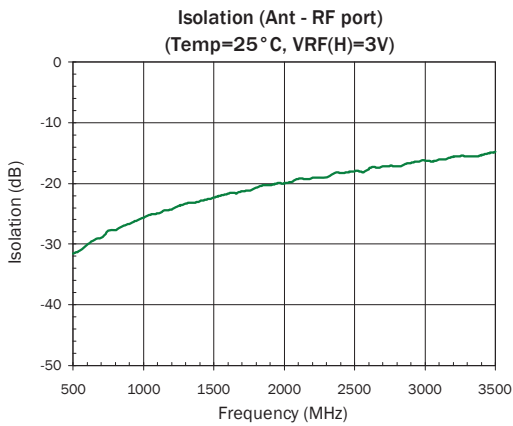
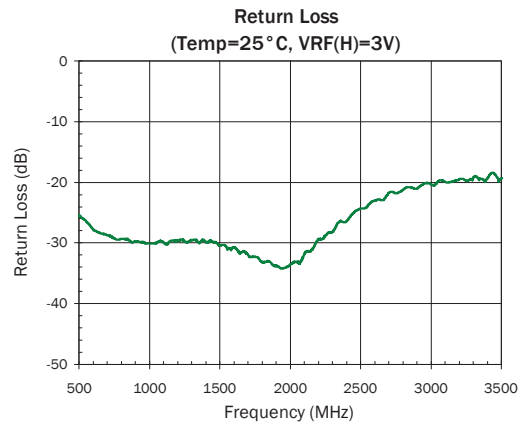
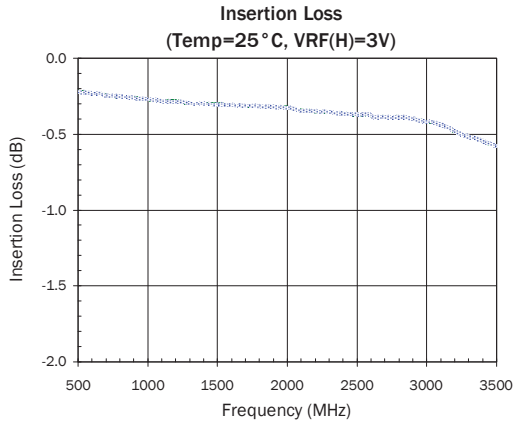

Looking for pricing, stock, or lifecycle information?

Click below to explore more details on WIN SOURCE:

 [View RF1126TR7 on WIN SOURCE](#)

 [RF Micro Devices](#) Information

Optimize Your Supply Chain with WIN SOURCE Solutions

-  Global Sourcing Solution
-  Obsolete Management
-  Cost Control Management
-  Shortage Management
-  Alternative Solution
-  Excess Inventory Management