



**THE DATASHEET OF
REF5045AIDGKR**



REF50xx

Low-Noise, Very Low Drift, Precision Voltage Reference

1 Features

- Low temperature drift:
 - High-grade: 3 ppm/°C (maximum)
 - Standard-grade: 8 ppm/°C (maximum)
- High accuracy:
 - High-grade: 0.05% (maximum)
 - Standard-grade: 0.1% (maximum)
- Low noise: 3 $\mu\text{V}_{\text{PP}}/\text{V}$
- Excellent long-term stability:
 - 22 ppm after first 1000 hours (SOIC-8)
 - 50 ppm after first 1000 hours (VSSOP-8)
- High-output current: ± 10 mA
- Temperature range: -40°C to 125°C

2 Applications

- [Precision data acquisition systems](#)
- [Semiconductor test equipment](#)
- [Industrial process controls](#)
- [Medical instrumentation](#)
- [Pressure and temperature transmitters](#)
- [Lab and field instrumentation](#)

3 Description

The REF50xx is a family of low-noise, low-drift, very high precision voltage references. These references are capable of both sinking and sourcing current, and have excellent line and load regulation.

Excellent temperature drift (3 ppm/°C) and high accuracy (0.05%) are achieved using proprietary design techniques. These features, combined with very low noise, make the REF50xx family an excellent choice for use in high-precision data acquisition systems.

Each reference voltage is available in both high grade (REF50xxIDGK and REF50xxID) and standard grade (REF50xxAIDGK and REF50xxAID). The reference voltages are offered in 8-pin VSSOP and SOIC packages, and are specified from -40°C to 125°C .

Device Information

| PART NUMBER | PACKAGE (1) | BODY SIZE (NOM) |
|-------------|-------------|-------------------|
| REF50xx | SOIC (8) | 4.90 mm × 3.91 mm |
| | VSSOP (8) | 3.00 mm × 3.00 mm |

(1) For all available packages, see the orderable addendum at the end of the data sheet.

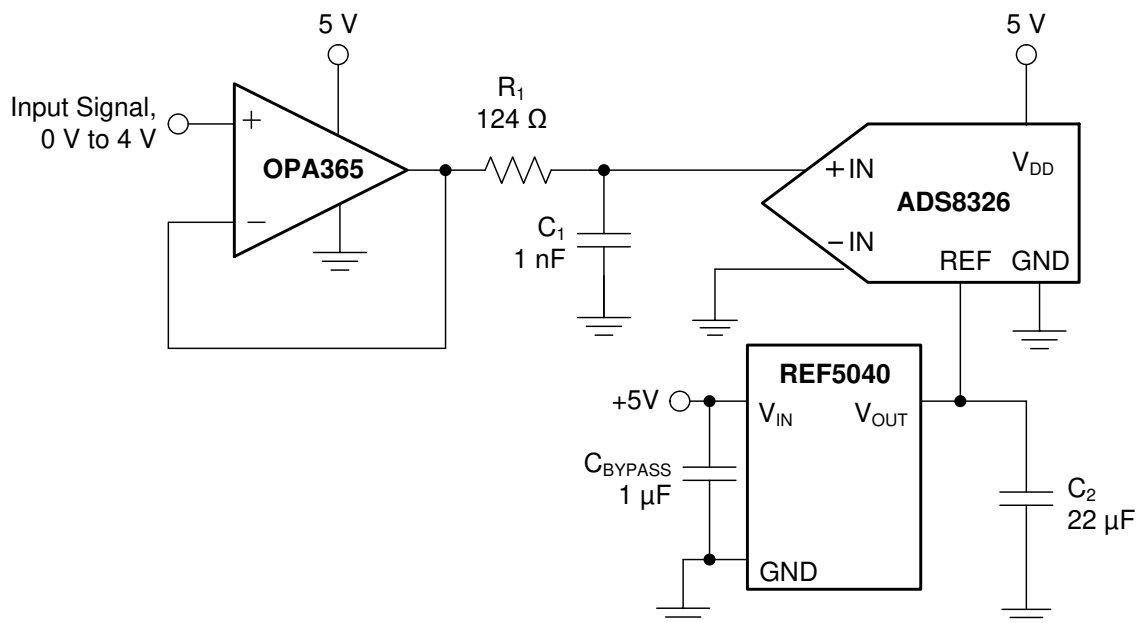

Copyright © 2016, Texas Instruments Incorporated

Simplified Schematic



Table of Contents

| | | | |
|--------------------------------------------------|----|------------------------------------------------------------------|----|
| 1 Features | 1 | 9.4 Device Functional Modes..... | 18 |
| 2 Applications | 1 | 10 Applications and Implementation | 19 |
| 3 Description | 1 | 10.1 Application Information..... | 19 |
| 4 Revision History | 2 | 10.2 Typical Applications..... | 19 |
| 5 Device Comparison Table | 3 | 11 Power Supply Recommendations | 20 |
| 6 Pin Configuration and Functions | 3 | 12 Layout | 21 |
| 7 Specifications | 4 | 12.1 Layout Guidelines..... | 21 |
| 7.1 Absolute Maximum Ratings..... | 4 | 12.2 Layout Example..... | 21 |
| 7.2 ESD Ratings..... | 4 | 12.3 Power Dissipation..... | 21 |
| 7.3 Recommended Operating Conditions..... | 4 | 13 Device and Documentation Support | 22 |
| 7.4 Thermal Information..... | 4 | 13.1 Documentation Support..... | 22 |
| 7.5 Electrical Characteristics..... | 5 | 13.2 Receiving Notification of Documentation Updates..... | 22 |
| 7.6 Typical Characteristics..... | 7 | 13.3 Support Resources..... | 22 |
| 8 Parameter Measurement Information | 12 | 13.4 Trademarks..... | 22 |
| 9 Detailed Description | 14 | 13.5 Glossary..... | 22 |
| 9.1 Overview..... | 14 | 14 Mechanical, Packaging, and Orderable Information | 22 |
| 9.2 Functional Block Diagram..... | 14 | | |
| 9.3 Feature Description..... | 15 | | |

4 Revision History

NOTE: Page numbers for previous revisions may differ from page numbers in the current version.

| Changes from Revision J (July 2022) to Revision K (June 2023) | Page |
|-------------------------------------------------------------------------------------------------------------------------------------------------------------|------|
| • Changed VSSOP 2000 hours LTD information line to SOIC -8 1000 hours LTD information..... | 1 |
| • Changed <i>Long-Term Stability</i> parameters and specifications for SOIC-8 package..... | 5 |
| • Changed output voltage noise to low frequency noise to <i>Electrical Characteristics</i> | 5 |
| • Added 10 Hz to 1 Khz noise information <i>Electrical Characteristics</i> | 5 |
| • Changed Long term stability spec for SOIC-8 Package <i>Electrical Characteristics</i> | 5 |
| • Changed Figure 7-28 | 7 |
| • Changed Figure 7-29 | 7 |
| • Changed Figure 7-30 | 7 |
| • Added noise density plot Figure 7-14 | 7 |
| • Changed title of flicker noise plot Figure 7-13 | 7 |
| • Changed all the load transient plot Figure 7-17 Figure 7-18 Figure 7-19 Figure 7-20 | 7 |
| • Changed the plot Figure 9-3 | 17 |

| Changes from Revision I (February 2020) to Revision J (July 2022) | Page |
|-------------------------------------------------------------------------------------------------------|------|
| • Updated the numbering format for tables, figures, and cross-references throughout the document..... | 1 |

| Changes from Revision H (June 2016) to Revision I (February 2020) | Page |
|-------------------------------------------------------------------|------|
| • Added <i>REF5045</i> to table..... | 5 |
| • Changed <i>Long-Term Stability</i> parameters..... | 5 |
| • Changed <i>Long-Term Stability</i> Graphs for VSSOP | 7 |
| • Added section on <i>Long-Term Stability</i> | 16 |

5 Device Comparison Table

| MODEL | OUTPUT VOLTAGE |
|---------|----------------|
| REF5020 | 2.048 V |
| REF5025 | 2.5 V |
| REF5030 | 3 V |
| REF5040 | 4.096 V |
| REF5045 | 4.5 V |
| REF5050 | 5 V |
| REF5010 | 10 V |

6 Pin Configuration and Functions

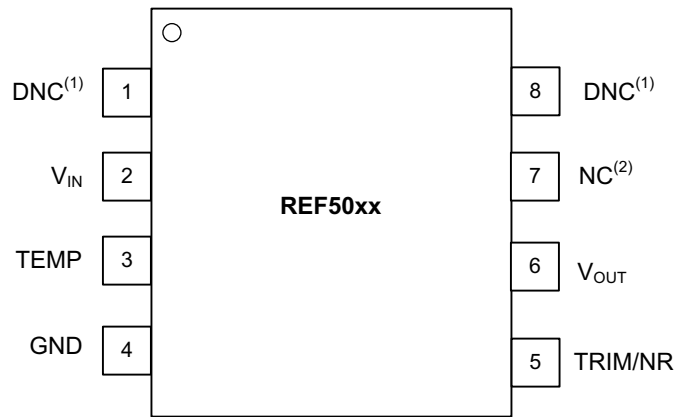

NOTES: (1) DNC = Do not connect.
(2) NC = No internal connection.

**Figure 6-1. D, DGK Packages
8-Pin SOIC, VSSOP
Top View**

Table 6-1. Pin Functions

| PIN | | DESCRIPTION |
|---------|-----|-----------------------------------------------------------------------------|
| NAME | NO. | |
| DNC | 1 | Do not connect |
| VIN | 2 | Input supply voltage |
| TEMP | 3 | Temperature monitoring pin. Provides a temperature-dependent output voltage |
| GND | 4 | Ground |
| TRIM/NR | 5 | Output adjustment and noise reduction pin |
| VOUT | 6 | Reference voltage output |
| NC | 7 | No internal connection |
| DNC | 8 | Do not connect |

7 Specifications

7.1 Absolute Maximum Ratings

over operating free-air temperature range (unless otherwise noted)⁽¹⁾

| | MIN | MAX | UNIT |
|-------------------------------------------|------|-----|------|
| Input voltage | -0.2 | 18 | V |
| Output short circuit | -30 | 30 | mA |
| Operating temperature | -55 | 125 | °C |
| Junction temperature (T _J max) | | 150 | °C |
| Storage temperature, T _{stg} | -65 | 150 | °C |

- (1) Stresses above these ratings may cause permanent damage. Exposure to absolute maximum conditions for extended periods may degrade device reliability. These are stress ratings only, and functional operation of the device at these or any other conditions beyond those specified is not implied.

7.2 ESD Ratings

| | | VALUE | UNIT |
|--------------------------------------------|--------------------------------------------------------------------------------|-------|------|
| V _(ESD) Electrostatic discharge | Human body model (HBM), per ANSI/ESDA/JEDEC JS-001 ⁽¹⁾ | ±3000 | V |
| | Charged device model (CDM), per JEDEC specification JESD22-C101 ⁽²⁾ | ±1000 | |

- (1) JEDEC document JEP155 states that 500-V HBM allows safe manufacturing with a standard ESD control process.
 (2) JEDEC document JEP157 states that 250-V CDM allows safe manufacturing with a standard ESD control process.

7.3 Recommended Operating Conditions

over operating free-air temperature range (unless otherwise noted)

| | MIN | NOM | MAX | UNIT |
|------------------|-----------------------------------------|-----|-----|------|
| V _{IN} | V _{OUT} + 0.2 V ⁽¹⁾ | | 18 | V |
| I _{OUT} | -10 | | 10 | mA |

- (1) Except for the REF5020, where V_{IN} (minimum) = 2.7 V

7.4 Thermal Information

| THERMAL METRIC ⁽¹⁾ | | REF50xx | | UNIT |
|-------------------------------|----------------------------------------------|----------|-------------|------|
| | | D (SOIC) | DGK (VSSOP) | |
| | | 8 PINS | 8 PINS | |
| R _{θJA} | Junction-to-ambient thermal resistance | 115 | 160.9 | °C/W |
| R _{θJC(top)} | Junction-to-case (top) thermal resistance | 63.4 | 53.9 | °C/W |
| R _{θJB} | Junction-to-board thermal resistance | 57.1 | 82.3 | °C/W |
| Ψ _{JT} | Junction-to-top characterization parameter | 15.4 | 5.1 | °C/W |
| Ψ _{JB} | Junction-to-board characterization parameter | 56.2 | 80.7 | °C/W |
| R _{θJC(bot)} | Junction-to-case (bottom) thermal resistance | N/A | N/A | °C/W |

- (1) For more information about traditional and new thermal metrics, see the *Semiconductor and IC Package Thermal Metrics* application report, [SPRA953](#).

7.5 Electrical Characteristics

At $T_A = 25^\circ\text{C}$, $I_{\text{LOAD}} = 0$, $C_L = 1\ \mu\text{F}$, and $V_{\text{IN}} = (V_{\text{OUT}} + 0.2\ \text{V})$ to 18 V, unless otherwise noted

| PARAMETER | | TEST CONDITIONS | MIN | TYP | MAX | UNIT |
|----------------------------------------------|----------------------------------|---------------------------------------------------------------------------------------------------------------------------------------------------------------------------------|---------------------------------------------------|-------|-------|-------------------------------------|
| OUTPUT VOLTAGE | | | | | | |
| V_{OUT} | Output voltage | REF5020 ($V_{\text{OUT}} = 2.048\ \text{V}$) ⁽¹⁾ , $2.7\ \text{V} < V_{\text{IN}} < 18\ \text{V}$ | | 2.048 | | V |
| | | REF5025 | | 2.5 | | |
| | | REF5030 | | 3.0 | | |
| | | REF5040 | | 4.096 | | |
| | | REF5045 | | 4.5 | | |
| | | REF5050 | | 5.0 | | |
| | | REF5010 | | 10.0 | | |
| | Initial accuracy: high grade | All voltage options ⁽¹⁾ | -0.05% | | 0.05% | |
| | Initial accuracy: standard grade | All voltage options ⁽¹⁾ | -0.1% | | 0.1% | |
| NOISE | | | | | | |
| e_{npp} | Low Frequency noise | $f = 0.1\ \text{Hz}$ to 10 Hz | | 3 | | $\mu\text{V}_{\text{PP}}/\text{V}$ |
| e_{n} | Output Voltage Noise | $f = 10\ \text{Hz}$ to 1 kHz | | 0.9 | | $\mu\text{V}_{\text{RMS}}/\text{V}$ |
| OUTPUT VOLTAGE TEMPERATURE DRIFT | | | | | | |
| dV_{OUT}/dT | Output voltage temperature drift | | | | | |
| | High grade | | | 2.5 | 3 | ppm/ $^\circ\text{C}$ |
| | Standard grade | | | 3 | 8 | ppm/ $^\circ\text{C}$ |
| LINE REGULATION | | | | | | |
| $\Delta V_{\text{O}(\Delta V_{\text{I}})}$ | Line regulation | $V_{\text{IN}} = (V_{\text{OUT}} + 0.2)$ to 18 V ⁽⁴⁾ | | 0.1 | 1 | ppm/V |
| | | $V_{\text{IN}} = V_{\text{OUT}} + 0.2\ \text{V}$, $T_A = -40^\circ\text{C}$ to 125 $^\circ\text{C}$ ⁽⁴⁾ | | 0.2 | 1 | ppm/V |
| LOAD REGULATION | | | | | | |
| $\Delta V_{\text{O}(\Delta I_{\text{L}})}$ | Load regulation | $-10\ \text{mA} < I_{\text{LOAD}} < 10\ \text{mA}$, $V_{\text{IN}} = V_{\text{OUT}} + 0.75\ \text{V}$ ⁽⁵⁾ | | 20 | 30 | ppm/mA |
| | | $-10\ \text{mA} < I_{\text{LOAD}} < 10\ \text{mA}$, $V_{\text{IN}} = V_{\text{OUT}} + 0.75\ \text{V}$, $T_A = -40^\circ\text{C}$ to 125 $^\circ\text{C}$ ⁽⁵⁾ | | | 50 | ppm/mA |
| SHORT-CIRCUIT CURRENT | | | | | | |
| I_{SC} | Short circuit current | $V_{\text{OUT}} = 0$ | | 25 | | mA |
| THERMAL HYSTERESIS ^{(2) (3)} | | | | | | |
| | High grade | VSSOP-8 | Cycle 1 | | 50 | ppm |
| | Standard grade | VSSOP-8 | Cycle 1 | | 70 | ppm |
| | High grade | SOIC-8 | Cycle 1 | | 70 | ppm |
| | Standard grade | SOIC-8 | Cycle 1 | | 90 | ppm |
| | High grade | VSSOP-8 | Cycle 2 | | 40 | ppm |
| | Standard grade | VSSOP-8 | Cycle 2 | | 40 | ppm |
| | High grade | SOIC-8 | Cycle 2 | | 50 | ppm |
| | Standard grade | SOIC-8 | Cycle 2 | | 50 | ppm |
| LONG-TERM STABILITY ⁽³⁾ | | | | | | |
| | | VSSOP-8 | 0 to 1000 hours | | 50 | ppm/1000 hr |
| | | VSSOP-8 | 1000 to 2000 hours | | 25 | ppm/1000 hr |
| | | SOIC-8 | 0 to 1000 hours | | 22 | ppm/1000 hr |
| | | SOIC-8 | 1000 to 2000 hours | | 18 | ppm/1000 hr |
| TEMP PIN | | | | | | |
| | Voltage output | | At $T_A = 25^\circ\text{C}$ | | 575 | mV |
| | Temperature sensitivity | | $T_A = -40^\circ\text{C}$ to 125 $^\circ\text{C}$ | | 2.64 | mV/ $^\circ\text{C}$ |
| TURN-ON SETTLING TIME | | | | | | |
| | Turn-on settling time | | To 0.1% with $C_L = 1\ \mu\text{F}$ | | 200 | μs |

7.5 Electrical Characteristics (continued)

At $T_A = 25^\circ\text{C}$, $I_{\text{LOAD}} = 0$, $C_L = 1\ \mu\text{F}$, and $V_{\text{IN}} = (V_{\text{OUT}} + 0.2\ \text{V})$ to 18 V, unless otherwise noted

| PARAMETER | | TEST CONDITIONS | MIN | TYP | MAX | UNIT |
|--------------------------|-------------------|--------------------------------------------------|------------------------------|-----|-----|------------------|
| POWER SUPPLY | | | | | | |
| V_S | Supply voltage | See note (1) | $V_{\text{OUT}} + 0.2^{(1)}$ | | 18 | V |
| | Quiescent current | | | 0.8 | 1 | mA |
| | | $T_A = -40^\circ\text{C}$ to 125°C | | | 1.2 | mA |
| TEMPERATURE RANGE | | | | | | |
| | Specified range | | -40 | | 125 | $^\circ\text{C}$ |
| | Operating range | | -55 | | 125 | $^\circ\text{C}$ |

- (1) For $V_{\text{OUT}} \leq 2.5\ \text{V}$, the minimum supply voltage is 2.7 V.
- (2) The thermal hysteresis procedure is explained in more detail in [Section 9.3.3](#).
- (3) Data collected using devices soldered onto the test board.
- (4) Except for REF5020, where $V_{\text{IN}} = 2.7\ \text{V}$ to 18 V
- (5) Except for REF5020, where $V_{\text{IN}} = 3\ \text{V}$

7.6 Typical Characteristics

At $T_A = 25^\circ\text{C}$, $I_{\text{LOAD}} = 0$, and $V_S = V_{\text{OUT}} + 0.2\text{ V}$, unless otherwise noted. For $V_{\text{OUT}} \leq 2.5\text{ V}$, the minimum supply voltage is 2.7 V.

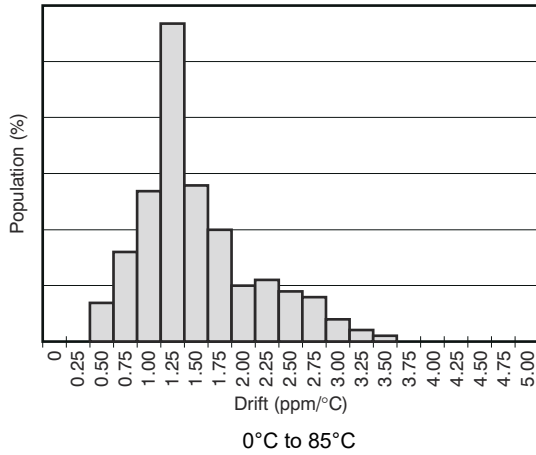

Figure 7-1. Temperature Drift

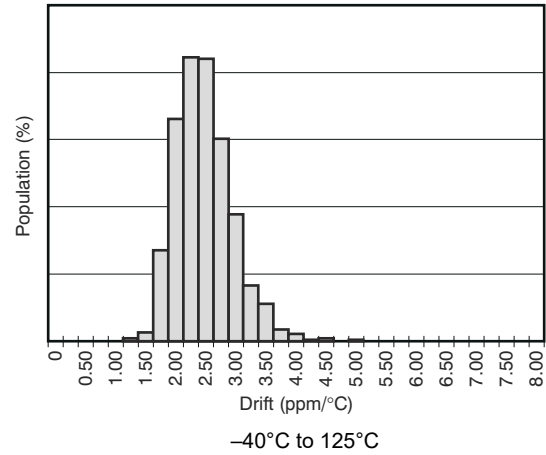

Figure 7-2. Temperature Drift

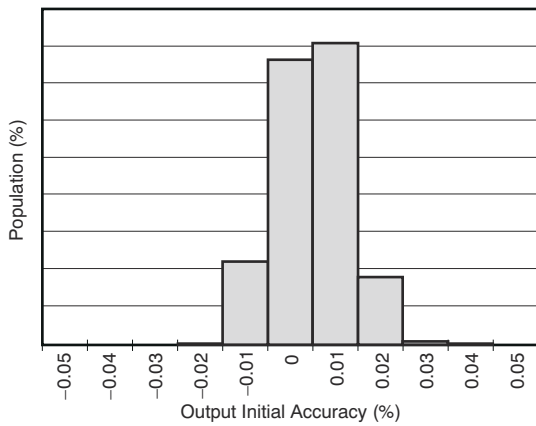

Figure 7-3. Output Voltage Initial Accuracy

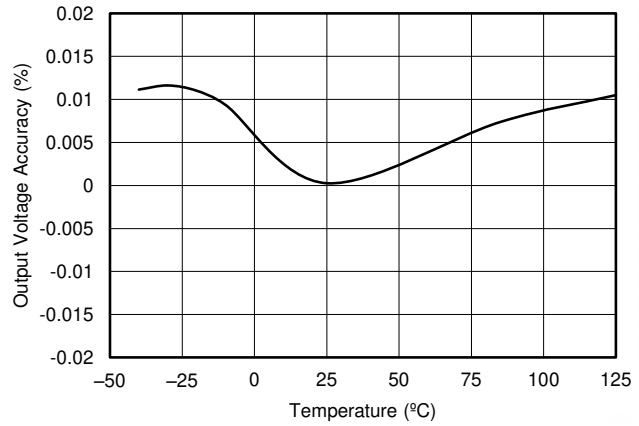

Figure 7-4. Output Voltage Accuracy vs Temperature

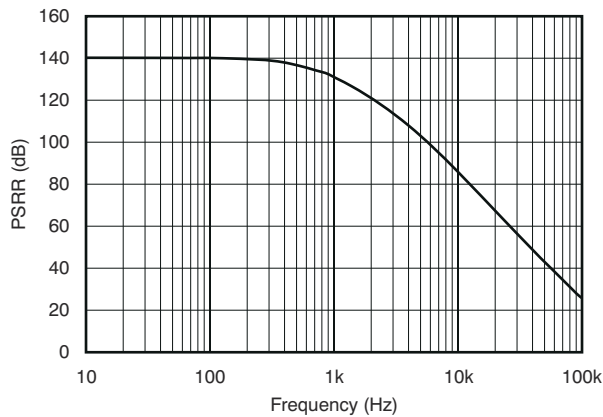

Figure 7-5. Power-Supply Rejection Ratio vs Frequency

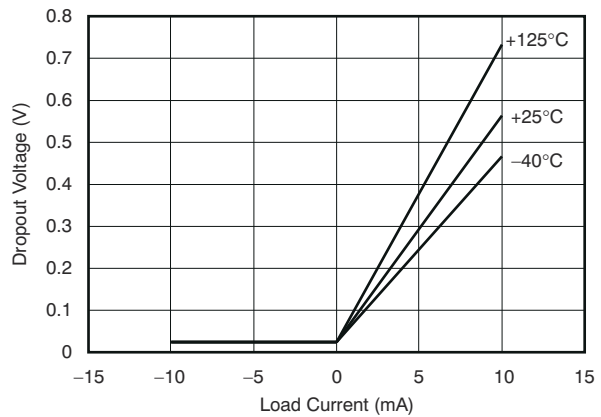

Figure 7-6. Dropout Voltage vs Load Current

7.6 Typical Characteristics (continued)

At $T_A = 25^\circ\text{C}$, $I_{\text{LOAD}} = 0$, and $V_S = V_{\text{OUT}} + 0.2\text{ V}$, unless otherwise noted. For $V_{\text{OUT}} \leq 2.5\text{ V}$, the minimum supply voltage is 2.7 V.

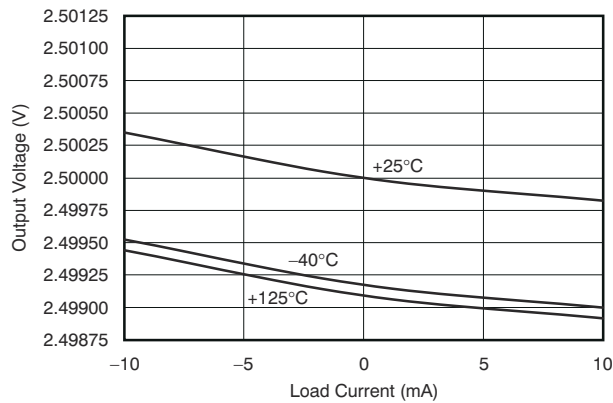

Figure 7-7. REF5025 Output Voltage vs Load Current

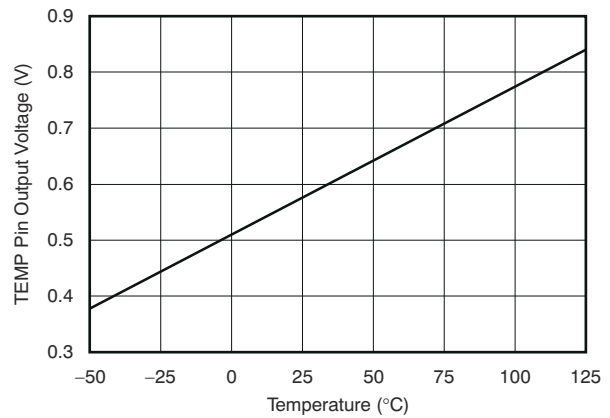

Figure 7-8. Temp Pin Output Voltage vs Temperature

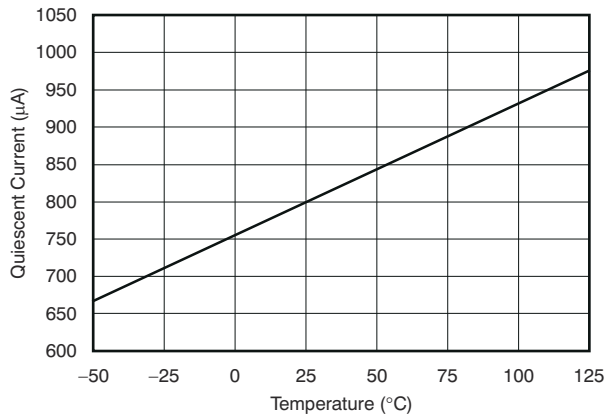

Figure 7-9. Quiescent Current vs Temperature

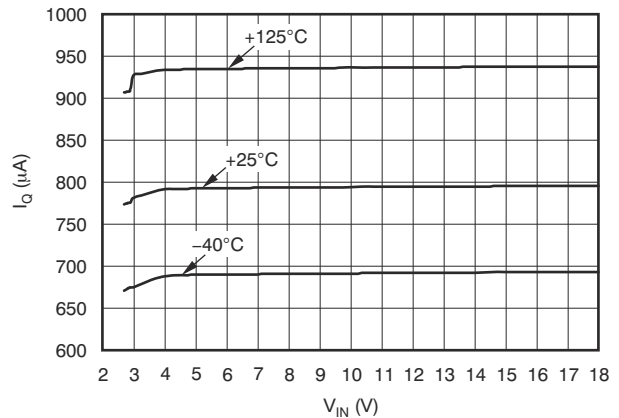

Figure 7-10. Quiescent Current vs Input Voltage

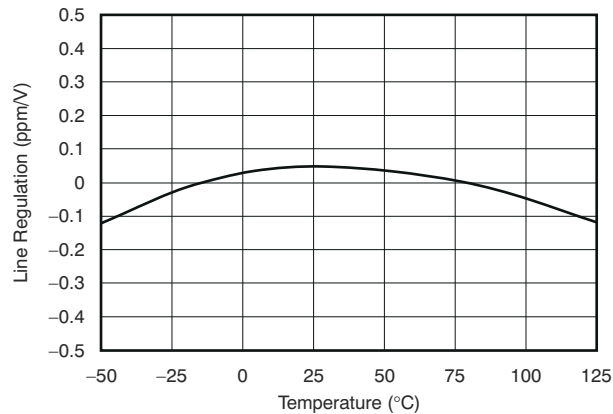

Figure 7-11. Line Regulation vs Temperature

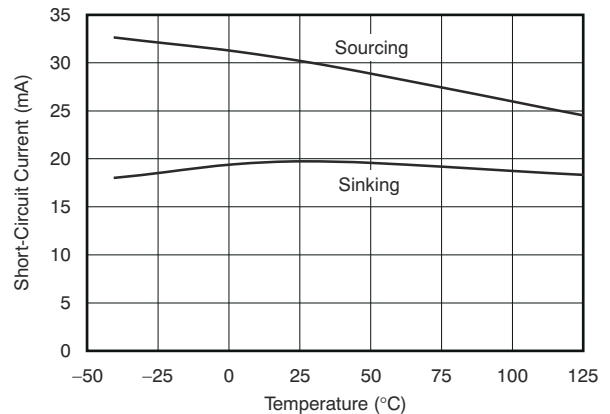

Figure 7-12. Short Circuit Current vs Temperature

7.6 Typical Characteristics (continued)

At $T_A = 25^\circ\text{C}$, $I_{\text{LOAD}} = 0$, and $V_S = V_{\text{OUT}} + 0.2\text{ V}$, unless otherwise noted. For $V_{\text{OUT}} \leq 2.5\text{ V}$, the minimum supply voltage is 2.7 V.

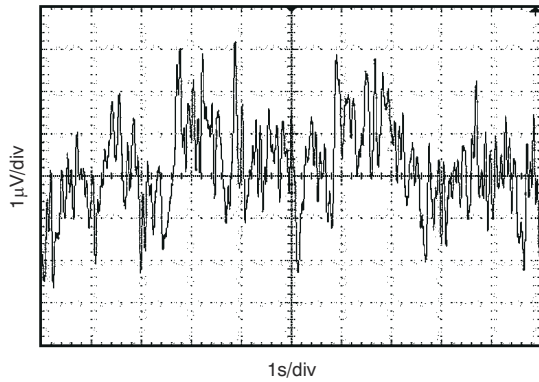

Figure 7-13. 0.1 Hz to 10 Hz Noise

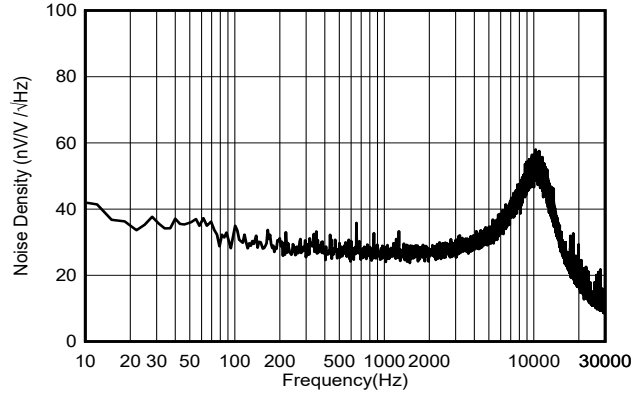
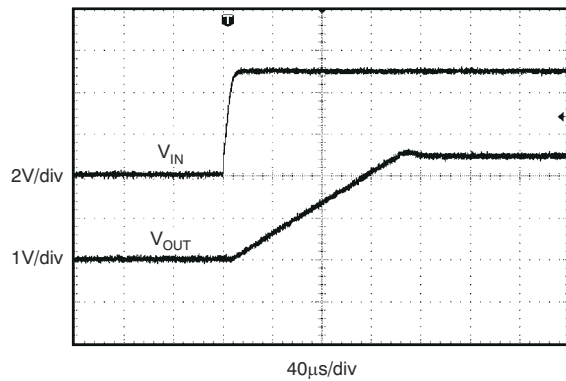
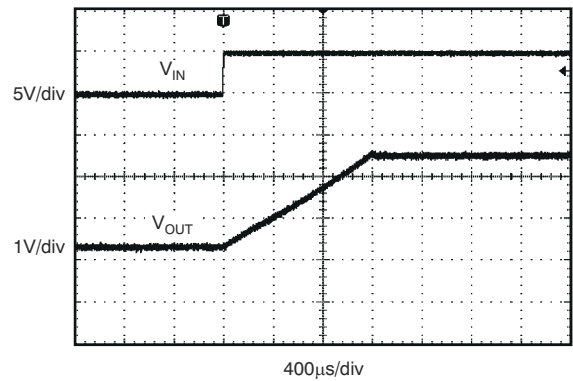

Figure 7-14. Noise Spectral Density



REF5025, $C_L = 1\ \mu\text{F}$
Figure 7-15. Start-Up



REF5025, $C_L = 10\ \mu\text{F}$
Figure 7-16. Start-Up

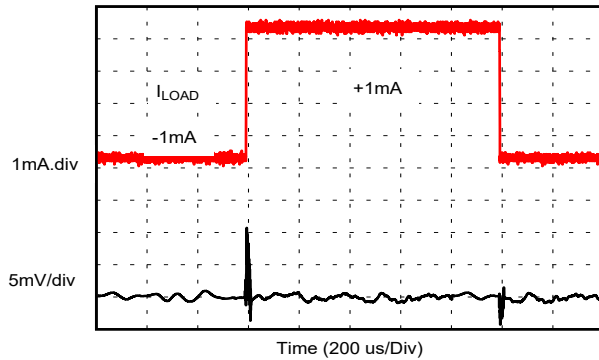

$C_L = 1\ \mu\text{F}$, $I_{\text{OUT}} = 1\ \text{mA}$
Figure 7-17. Load Transient

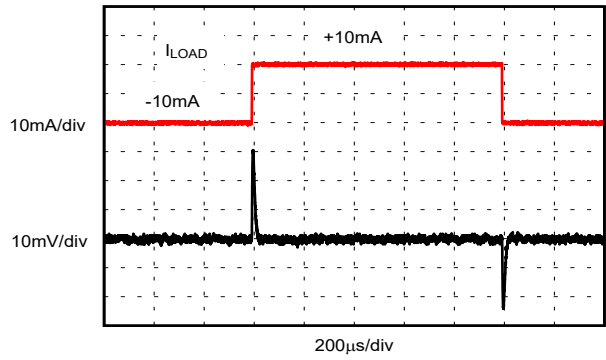

$C_L = 1\ \mu\text{F}$, $I_{\text{OUT}} = 10\ \text{mA}$
Figure 7-18. Load Transient

7.6 Typical Characteristics (continued)

At $T_A = 25^\circ\text{C}$, $I_{\text{LOAD}} = 0$, and $V_S = V_{\text{OUT}} + 0.2\text{ V}$, unless otherwise noted. For $V_{\text{OUT}} \leq 2.5\text{ V}$, the minimum supply voltage is 2.7 V.

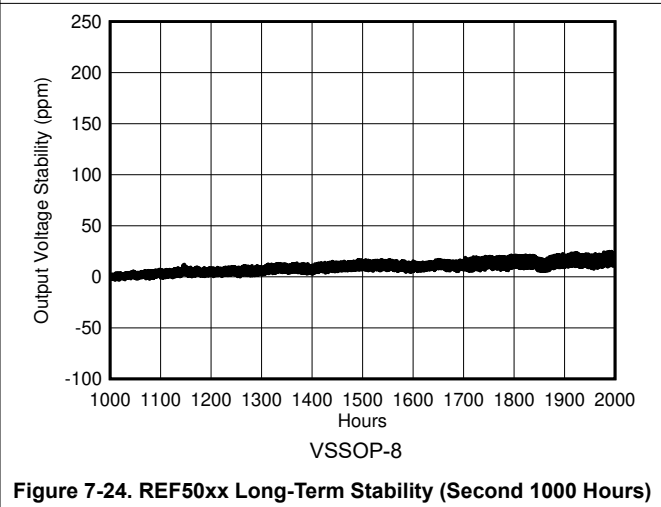
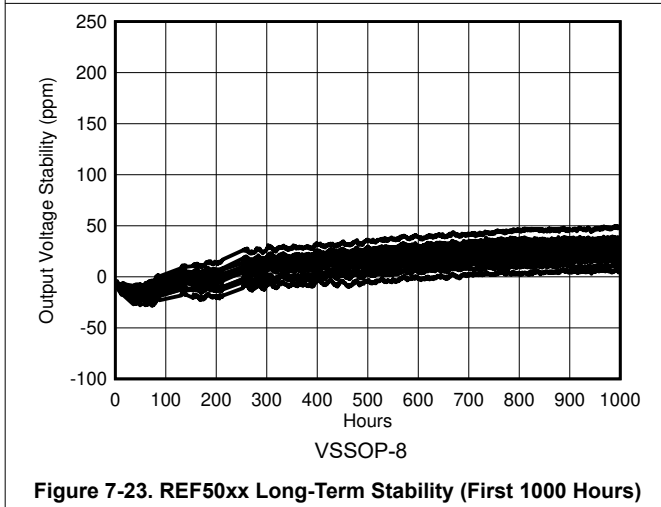
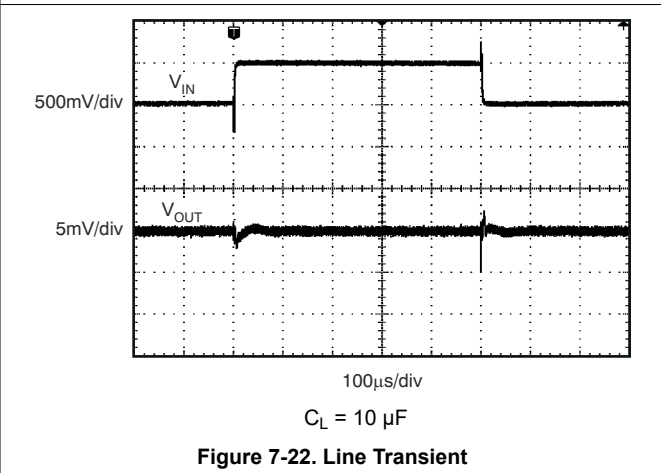
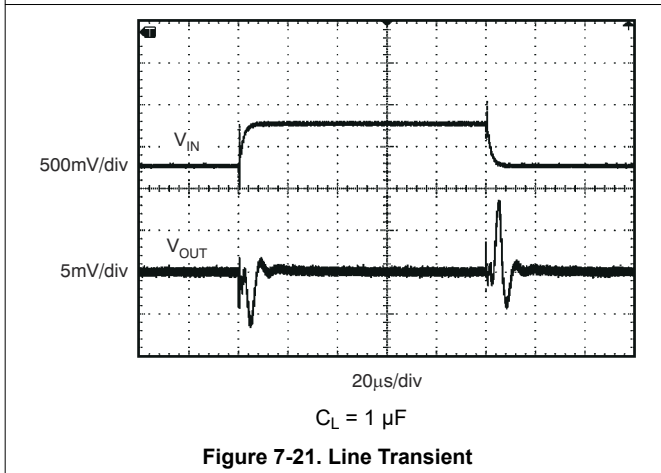
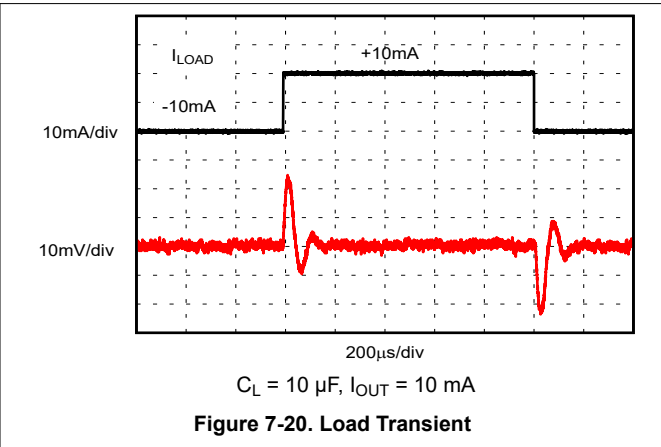
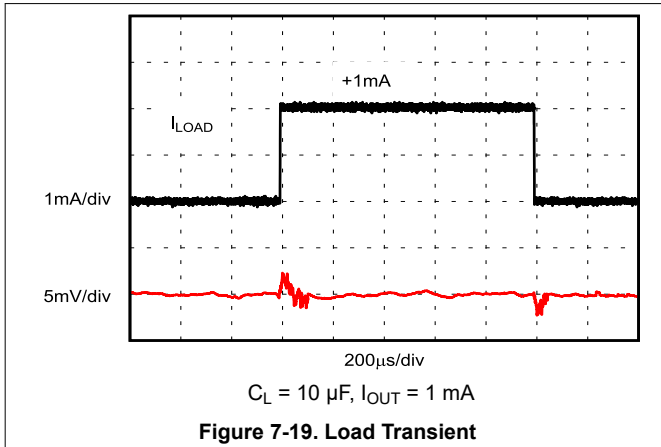

7.6 Typical Characteristics (continued)

At $T_A = 25^\circ\text{C}$, $I_{\text{LOAD}} = 0$, and $V_S = V_{\text{OUT}} + 0.2\text{ V}$, unless otherwise noted. For $V_{\text{OUT}} \leq 2.5\text{ V}$, the minimum supply voltage is 2.7 V.

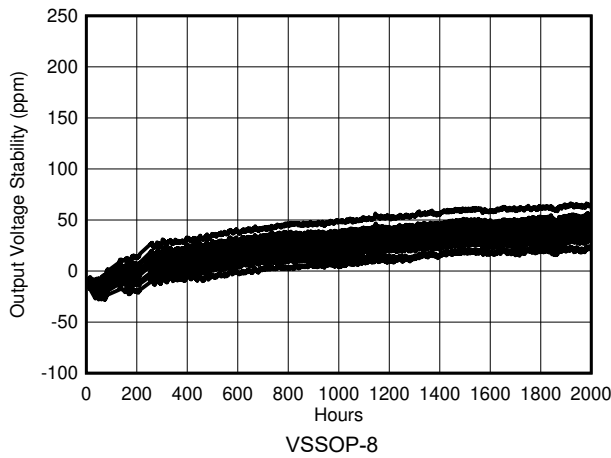

Figure 7-25. REF50xx Long-Term Stability (First 2000 Hours)

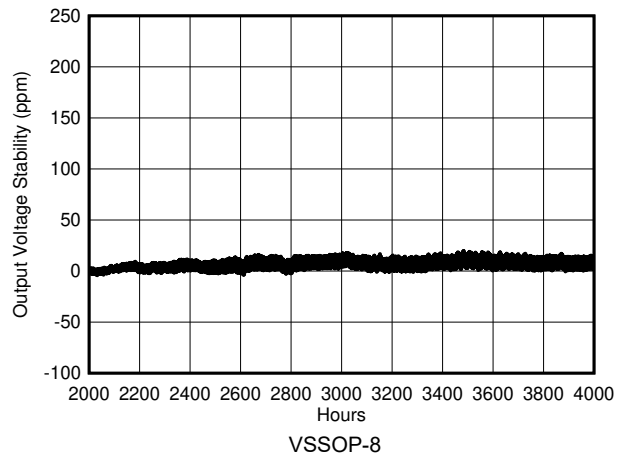

Figure 7-26. REF50xx Long-Term Stability (Second 2000 Hours)

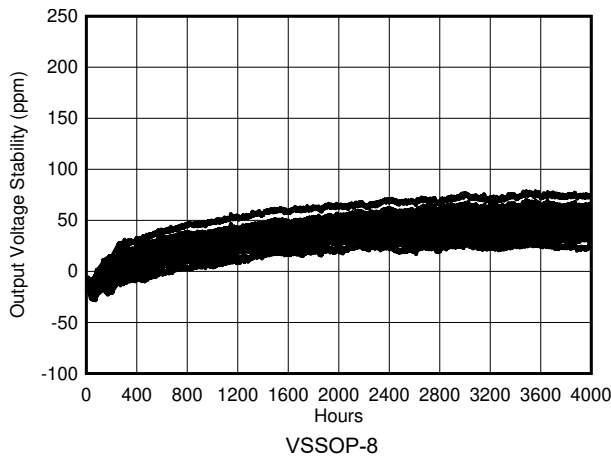

Figure 7-27. REF50xx Long-Term Stability (4000 Hours)

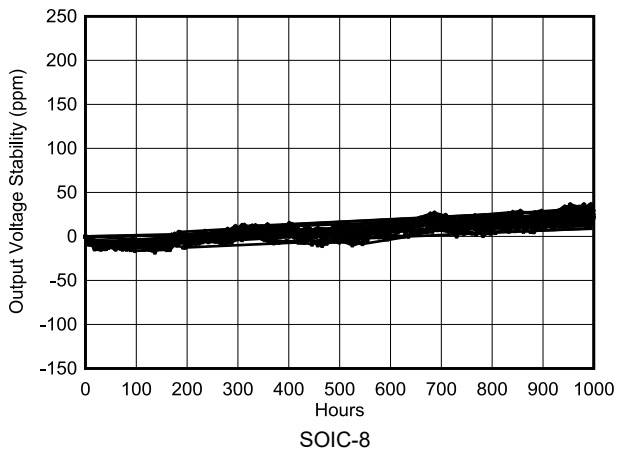

Figure 7-28. REF50xx Long-Term Stability (First 1000 Hours)

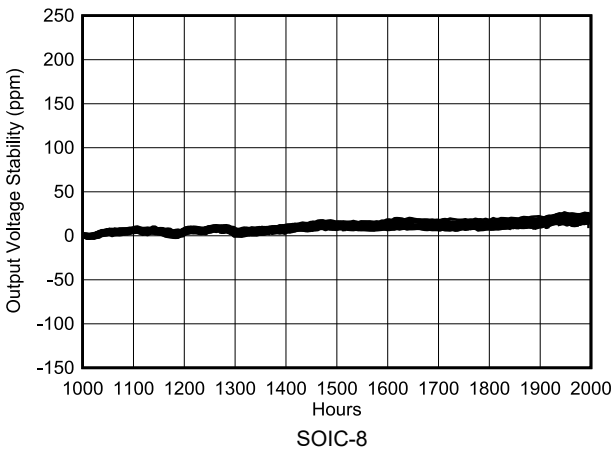

Figure 7-29. REF50xx Long-Term Stability (Second 1000 Hours)

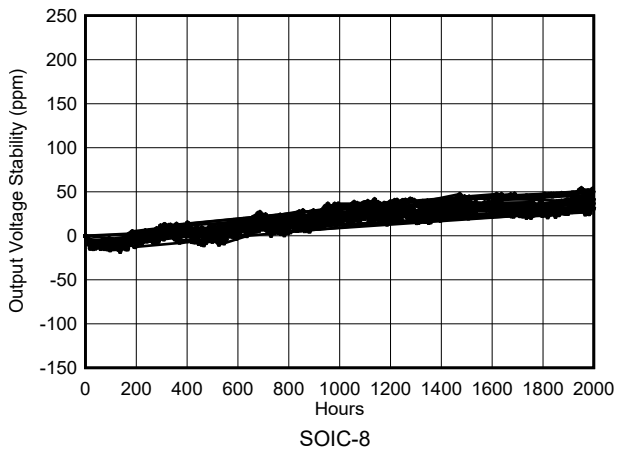

Figure 7-30. REF50xx Long-Term Stability (2000 Hours)

8 Parameter Measurement Information

Solder Heat Shift: The materials used in the manufacture of the REF50xx have differing coefficients of thermal expansion, resulting in stress on the device die when the part is heated. Mechanical and thermal stress on the device can cause the output voltages to shift, degrading the initial accuracy and drift specifications of the product. Reflow soldering is a common cause of this error.

To illustrate this effect, a total of 36 devices were soldered on printed-circuit-boards using lead-free solder paste and the paste manufacturer suggested reflow profile. The reflow profile is as shown in [Figure 8-1](#). The printed-circuit-board is comprised of FR4 material. The board thickness is 0.8 mm and the area is 13 mm × 13 mm.

The reference voltage is measured before and after the reflow process across temperature; the typical shift of accuracy and drift is displayed in [Figure 8-2](#) through [Figure 8-9](#). Although all tested units exhibit very low shifts, higher shifts are also possible depending on the size, thickness, and material of the printed-circuit-board. An important note is that the histograms display the typical shift for exposure to a single reflow profile. Exposure to multiple reflows, as is common on printed circuit boards (PCBs) with surface-mount components on both sides, causes additional shifts in the output bias voltage. If the PCB is exposed to multiple reflows, then solder the device in the last pass to minimize device exposure to thermal stress.

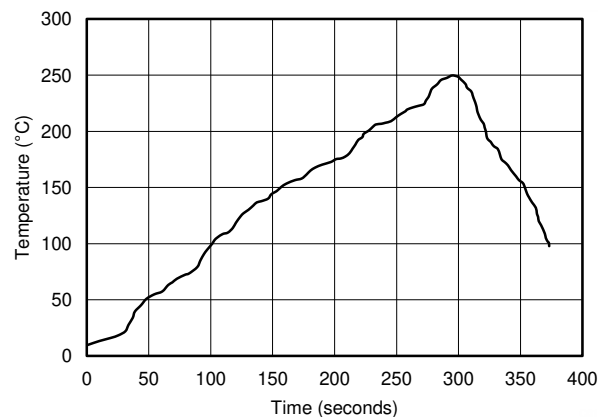

Figure 8-1. Reflow Profile

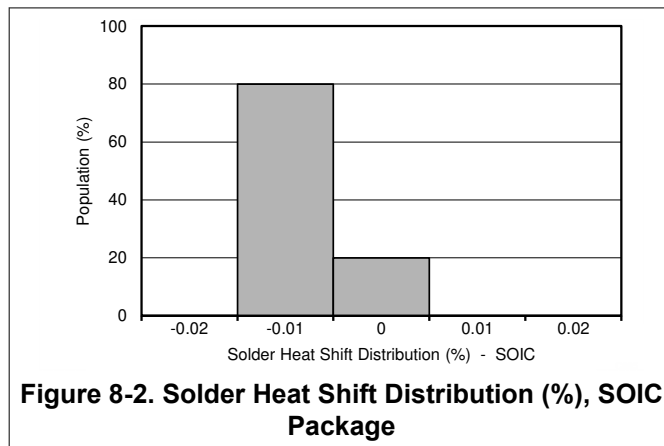

Figure 8-2. Solder Heat Shift Distribution (%), SOIC Package

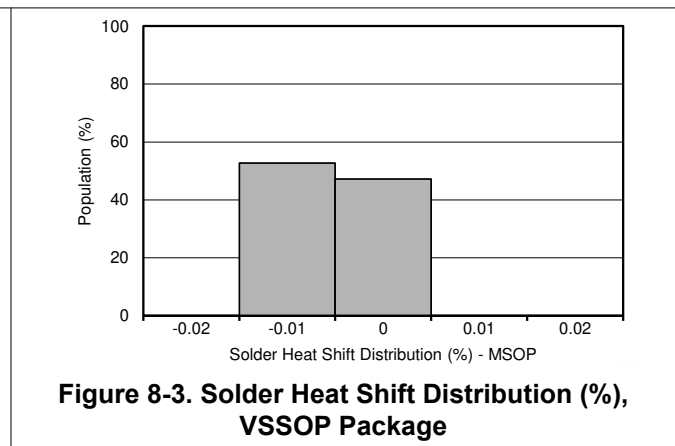

Figure 8-3. Solder Heat Shift Distribution (%), VSSOP Package

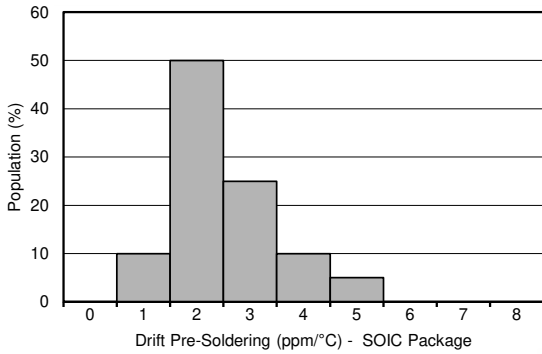

Figure 8-4. Drift Pre-Soldering Distribution, SOIC Package

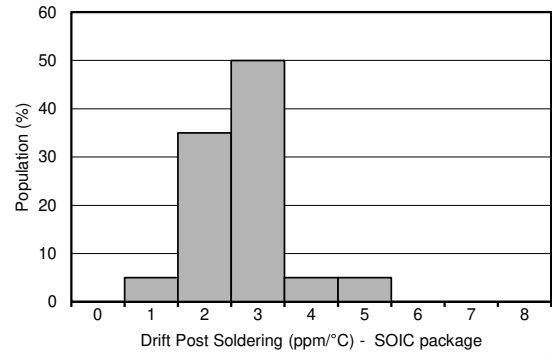

Figure 8-5. Drift Post Soldering Distribution, SOIC Package

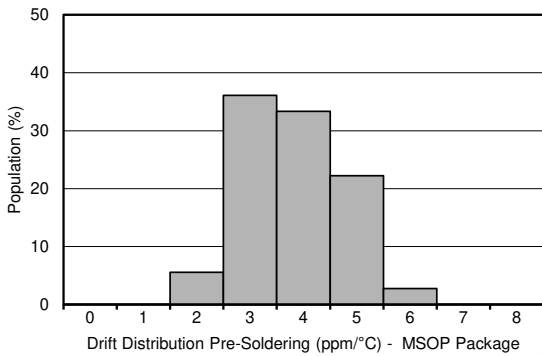

Figure 8-6. Drift Distribution Pre-Soldering, VSSOP Package

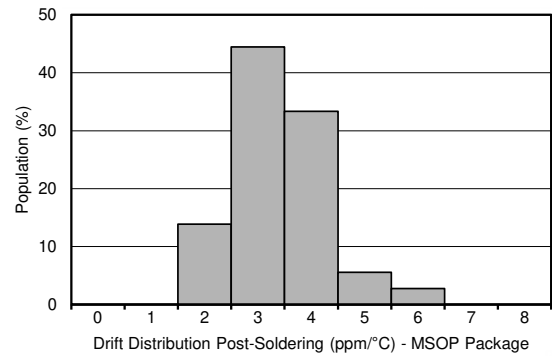

Figure 8-7. Drift Distribution Post-Soldering, VSSOP Package

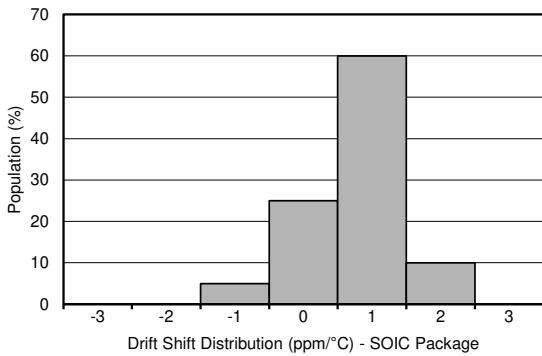

Figure 8-8. Drift Shift Distribution, SOIC Package

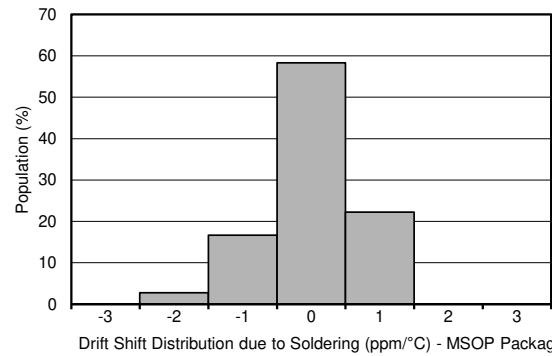

Figure 8-9. Drift Shift Distribution, VSSOP Package

9 Detailed Description

9.1 Overview

The REF50xx is family of low-noise, precision band-gap voltage references that are specifically designed for excellent initial voltage accuracy and drift. See [Section 9.2](#) for a simplified block diagram of the REF50xx.

9.2 Functional Block Diagram

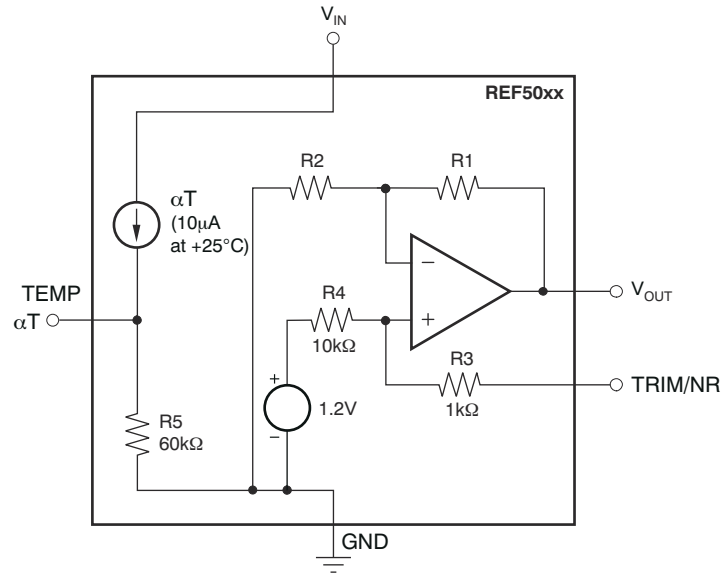

9.3 Feature Description

9.3.1 Temperature Monitoring

The temperature output terminal (TEMP, pin 3) provides a temperature-dependent voltage output with approximately 60-k Ω source impedance. As illustrated in Figure 7-8, the output voltage follows the nominal relationship:

$$V_{\text{TEMP PIN}} = 509 \text{ mV} + 2.64 \times T(^{\circ}\text{C}) \quad (1)$$

This pin indicates general chip temperature, accurate to approximately $\pm 15^{\circ}\text{C}$. Although not generally suitable for accurate temperature measurements, this pin can be used to indicate temperature changes or for temperature compensation of analog circuitry. A temperature change of 30°C corresponds to an approximate 79-mV change in voltage at the TEMP pin.

The TEMP pin has high-output impedance (see Section 9.2). Loading this pin with a low-impedance circuit induces a measurement error; however, this pin does not have any effect on V_{OUT} accuracy.

To avoid errors caused by low-impedance loading, buffer the TEMP pin output with a suitable low-temperature drift op amp, such as the OPA333, OPA335, or OPA376, as shown in Figure 9-1.

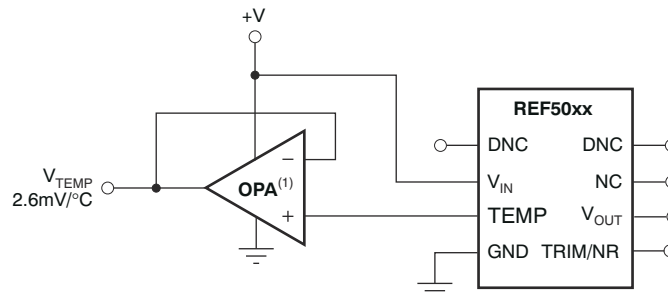

NOTE: (1) Low drift op amp, such as the OPA333, OPA335, or OPA376.

Figure 9-1. Buffering the TEMP Pin Output

9.3.2 Temperature Drift

The REF50xx is designed for minimal drift error, which is defined as the change in output voltage over temperature. The drift is calculated using the box method, as described in Equation 2.

$$\text{Drift} = \left(\frac{V_{\text{OUTMAX}} - V_{\text{OUTMIN}}}{V_{\text{OUT}} \times \text{Temp Range}} \right) \times 10^6 (\text{ppm}) \quad (2)$$

The REF50xx features a maximum drift coefficient of 3 ppm/ $^{\circ}\text{C}$ for the high-grade version, and 8 ppm/ $^{\circ}\text{C}$ for the standard-grade.

9.3.3 Thermal Hysteresis

Thermal hysteresis for the REF50xx is defined as the change in output voltage after operating the device at 25°C, cycling the device through the specified temperature range, and returning to 25°C. Thermal hysteresis can be expressed as Equation 3:

$$V_{\text{HYST}} = \left(\frac{|V_{\text{PRE}} - V_{\text{POST}}|}{V_{\text{NOM}}} \right) \cdot 10^6 \text{ (ppm)} \quad (3)$$

where

- V_{HYST} = thermal hysteresis (in units of ppm)
- V_{NOM} = the specified output voltage
- V_{PRE} = output voltage measured at 25°C pre-temperature cycling
- V_{POST} = output voltage measured after the device has been cycled from 25°C through the specified temperature range of –40°C to 125°C and returned to 25°C

9.3.4 Noise Performance

Typical 0.1-Hz to 10-Hz voltage noise for each member of the REF50xx family is specified in Section 7.5 table. The noise voltage increases with output voltage and operating temperature. Additional filtering can be used to improve output noise levels, although take care to ensure the output impedance does not degrade performance.

For additional information about how to minimize noise and maximize performance in mixed-signal applications such as data converters, refer to the [How a Voltage Reference Affects ADC Performance Part 1](#), [How a Voltage Reference Affects ADC Performance Part 2](#), and [How a Voltage Reference Affects ADC Performance Part 3](#) analog design journals.

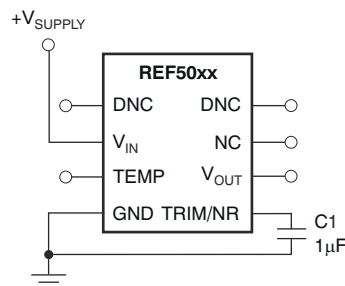

Figure 9-2. Noise Reduction Using the TRIM/NR Pin

9.3.5 Long-Term Stability

Due to aging and environmental effects, all semiconductor devices experience physical changes of the semiconductor die and the packaging material over time. These changes and the associated package stress on the die cause the output voltage in precision voltage references to deviate over time. The value of such change is specified in the data sheet by a parameter called the long-term stability (also known as the long-term drift (LTD)). Equation 4 shows how LTD is calculated. Note that the LTD value is positive if the output voltage drifts higher over time and negative if the voltage drifts lower over time. Figure 7-23 through Figure 7-30 show the drift of the output voltage for REF50xx over the first 4000 operating hours.

$$\text{LTD(ppm)}\Big|_{t=n} = \frac{(V_{\text{OUT}}\Big|_{t=0} - V_{\text{OUT}}\Big|_{t=n})}{V_{\text{OUT}}\Big|_{t=0}} \times 10^6 \quad (4)$$

where

- $\text{LTD(ppm)}\Big|_{t=n}$ = long-term stability (in units of ppm)
- $V_{\text{OUT}}\Big|_{t=0}$ = output voltage at time = 0 hr
- $V_{\text{OUT}}\Big|_{t=n}$ = output voltage at time = n hr

9.3.6 Output Adjustment Using the TRIM/NR Pin

The REF50xx provides a very accurate, factory-trimmed voltage output. However, V_{OUT} can be adjusted using the trim and noise reduction pin (TRIM/NR, pin 5). Figure 9-3 shows a typical circuit that allows an output adjustment of ± 15 mV.

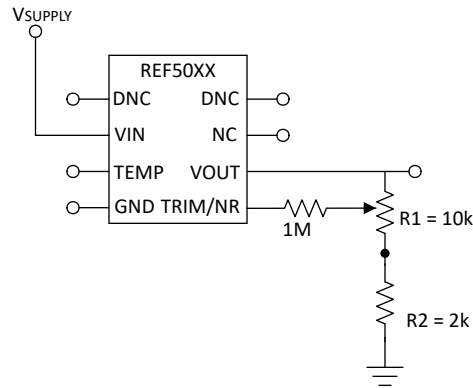

Figure 9-3. V_{OUT} Adjustment Using the TRIM/NR Pin

The REF50xx allows access to the band-gap through the TRIM/NR pin. Placing a capacitor from the TRIM/NR pin to GND (Figure 9-2) in combination with the internal R_3 and R_4 resistors creates a low-pass filter. A capacitance of 1 μ F creates a low-pass filter with the corner frequency from 10 Hz to 20 Hz. Such a filter decreases the overall noise measured on the V_{OUT} pin by half. Higher capacitance results in a lower filter cutoff frequency, further reducing output noise. Using this capacitor increases start-up time.

9.4 Device Functional Modes

9.4.1 Basic Connections

Figure 9-4 shows the typical connections for the REF50xx. TI recommends a supply bypass capacitor ranging from 1 μF to 10 μF . A 1- μF to 50- μF output capacitor (C_L) must be connected from V_{OUT} to GND. The equivalent series resistance (ESR) value of C_L must be less than or equal to 1.5 Ω to ensure output stability. To minimize noise, the recommended ESR of C_L is from 1 Ω and 1.5 Ω .

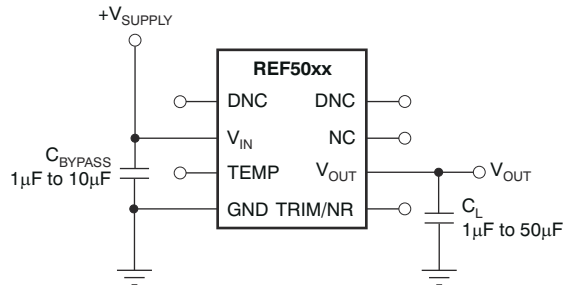

Figure 9-4. Basic Connections

9.4.2 Supply Voltage

The REF50xx family of voltage references features extremely low dropout voltage. With the exception of the REF5020, which has a minimum supply requirement of 2.7 V, these references can be operated with a supply of 200 mV more than the output voltage in an unloaded condition. For loaded conditions, a typical dropout voltage versus load plot is provided in Figure 7-6.

9.4.3 Negative Reference Voltage

For applications requiring a negative and positive reference voltage, the REF50xx and OPA735 can be used to provide a dual-supply reference from a 5-V supply. Figure 9-5 shows the REF5025 used to provide a 2.5-V supply reference voltage. The low-drift performance of the REF50xx complements the low offset voltage and zero drift of the OPA735 to provide an accurate solution for split-supply applications. Take care to match the temperature coefficients of R_1 and R_2 .

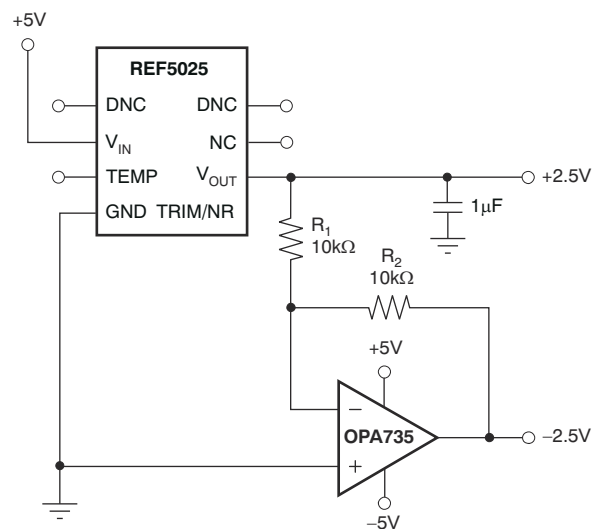

NOTE: Bypass capacitors not shown.

Figure 9-5. The REF5025 and OPA735 Create Positive and Negative Reference Voltages

10 Applications and Implementation

Note

Information in the following applications sections is not part of the TI component specification, and TI does not warrant its accuracy or completeness. TI's customers are responsible for determining suitability of components for their purposes, as well as validating and testing their design implementation to confirm system functionality.

10.1 Application Information

Data acquisition systems often require stable voltage references to maintain accuracy. The REF50xx family features low noise, very low drift, and high initial accuracy for high-performance data converters. [Figure 10-1](#) shows the REF5040 in a basic data acquisition system.

10.2 Typical Applications

10.2.1 16-Bit, 250-KSPS Data Acquisition System

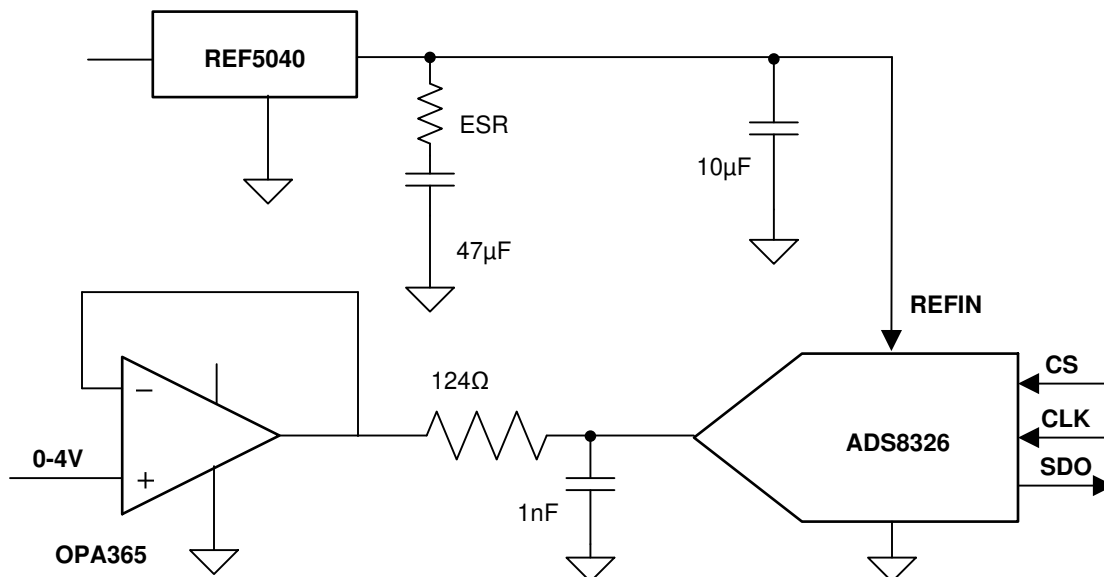

Figure 10-1. Complete Data Acquisition System Using the REF50xx

10.2.1.1 Design Requirements

When using the REF50xx in the design, select a proper output capacitor that does not create gain peaking, thereby increasing total system noise. At the same time, the capacitor must be selected to provide required filtering performance for the system. In addition, input bypass capacitor and noise reduction capacitors must be added for optimum performances. During the design of the data acquisition system, equal consideration must be given to the buffering analog input signal as well as the reference voltage. Having a properly designed input buffer with an associated RC filter is a necessary requirement for good performance of the data acquisition system.

10.2.1.2 Detailed Design Procedure

The OPA365 is used to drive the 16-bit analog-to-digital converter (ADS8326). The RC filter at the output of the OPA365 is used to reduce the charge kick-back created by the opening and closing of the sampling switch inside the ADC. Design the RC filter such that the voltage at the sampling capacitor settles to 16-bit accuracy within the acquisition time of the ADC. The bandwidth of the driving amplifier must at least be four times the bandwidth of the RC filter.

The REF5040 is used to drive the REF pin of the ADS8326. Proper selection of voltage reference output capacitor is very important for this design. Very low equivalent series resistance (ESR) creates gain-peaking, which degrades SNR of the total system. If the ESR of the capacitor is not enough, then an additional resistor must be added in series with the output capacitor. A capacitance of 1 μF can be connected to the NR pin to reduce band-gap noise of the REF50xx.

SNR measurements using different RC filters at the output of the OPA365, different values of output capacitor for the REF50xx and different values of capacitors at the TRIM/NR pin are shown in [Table 10-1](#).

Table 10-1. Data Acquisition Measurement Results for Different Conditions

| | TEST CONDITION 1 | TEST CONDITION 2 |
|--------------------------|---------------------|-------------------------------------|
| OPA365 RC filter | 124 Ω , 1 nF | 124 Ω , 1 nF |
| REF5040 output capacitor | 10 μF | 10 μF + 47 μF |
| TRIM/NR pin capacitor | 0 μF | 1 μF |
| SNR | 86.7 dB | 92.8 dB |

10.2.1.3 Application Curve

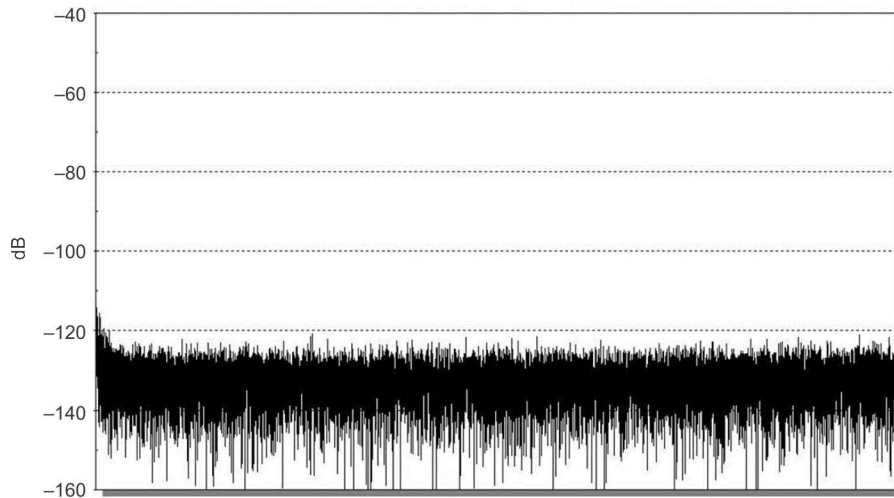

Figure 10-2. FFT Plot-Noise Floor of Data Acquisition System

11 Power Supply Recommendations

The REF50xx family of voltage references features extremely low dropout voltage. With the exception of the REF5020, which has a minimum supply requirement of 2.7 V, these references can be operated with a supply of 200 mV more than the output voltage in an unloaded condition. For loaded conditions, a typical dropout voltage versus load plot is provided in [Figure 7-6](#). TI recommends a supply bypass capacitor ranging from 1 μF to 50 μF .

12 Layout

12.1 Layout Guidelines

- Place the power-supply bypass capacitor as closely as possible to the supply and ground pins. The recommended value of this bypass capacitor is from 1 μ F to 10 μ F. If necessary, additional decoupling capacitance can be added to compensate for noisy or high-impedance power supplies.
- Place a 1- μ F noise filtering capacitor between the NR pin and ground.
- The output must be decoupled with a 1- μ F to 50- μ F capacitor. A resistor in series with the output capacitor is optional. For better noise performance, the recommended ESR on the output capacitor is from 1 Ω to 1.5 Ω .
- A high-frequency, 1- μ F capacitor can be added in parallel between the output and ground to filter noise and help with switching loads as data converters.

12.2 Layout Example

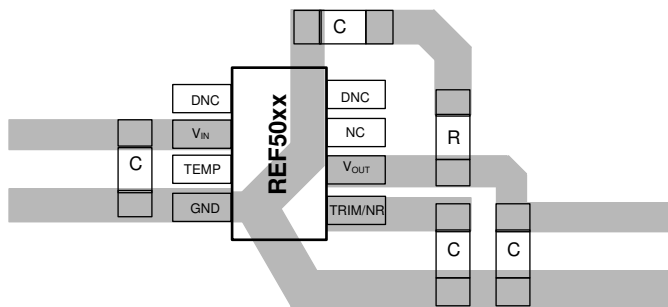

Figure 12-1. Layout Example

12.3 Power Dissipation

The REF50xx family is specified to deliver current loads of ± 10 mA over the specified input voltage range. The temperature of the device increases according to [Equation 5](#):

$$T_J = T_A + P_D \times \theta_{JA} \quad (5)$$

where

- T_J = junction temperature ($^{\circ}$ C)
- T_A = ambient temperature ($^{\circ}$ C)
- P_D = power dissipated (W)
- θ_{JA} = junction-to-ambient thermal resistance ($^{\circ}$ C/W)

The REF50xx junction temperature must not exceed the absolute maximum rating of 150 $^{\circ}$ C.

13 Device and Documentation Support

13.1 Documentation Support

13.1.1 Related Documentation

For related documentation see the following:

- Texas Instruments, [0.05 \$\mu\text{V}/^\circ\text{C}\$ \(Maximum\), Single-Supply CMOS Zero-Drift Series Operational Amplifier](#) data sheet
- [REF5020 PSpice Model](#).
- [REF5020 TINA-TI Reference Design](#)
- [REF5020 TINA-TI Spice Model](#)
- [INA270 PSpice Model](#)
- [INA270 TINA-TI Reference Design](#)
- [INA270 TINA-TI Spice Model](#)

13.2 Receiving Notification of Documentation Updates

To receive notification of documentation updates, navigate to the device product folder on [ti.com](#). Click on *Subscribe to updates* to register and receive a weekly digest of any product information that has changed. For change details, review the revision history included in any revised document.

13.3 Support Resources

[TI E2E™ support forums](#) are an engineer's go-to source for fast, verified answers and design help — straight from the experts. Search existing answers or ask your own question to get the quick design help you need.

Linked content is provided "AS IS" by the respective contributors. They do not constitute TI specifications and do not necessarily reflect TI's views; see TI's [Terms of Use](#).

13.4 Trademarks

TI E2E™ is a trademark of Texas Instruments.

All trademarks are the property of their respective owners.

13.5 Glossary

[TI Glossary](#) This glossary lists and explains terms, acronyms, and definitions.

14 Mechanical, Packaging, and Orderable Information

The following pages include mechanical, packaging, and orderable information. This information is the most current data available for the designated devices. This data is subject to change without notice and revision of this document. For browser-based versions of this data sheet, refer to the left-hand navigation.

PACKAGING INFORMATION

| Orderable Device | Status (1) | Package Type | Package Drawing | Pins | Package Qty | Eco Plan (2) | Lead finish/ Ball material (6) | MSL Peak Temp (3) | Op Temp (°C) | Device Marking (4/5) | Samples |
|------------------|---------------|--------------|-----------------|------|-------------|-----------------|--------------------------------------|----------------------|--------------|-------------------------|-------------------------|
| REF5010AID | ACTIVE | SOIC | D | 8 | 75 | RoHS & Green | Call TI | Level-2-260C-1 YEAR | -40 to 125 | REF 5010 A | Samples |
| REF5010AIDGKR | ACTIVE | VSSOP | DGK | 8 | 2500 | RoHS & Green | NIPDAU | Level-2-260C-1 YEAR | -40 to 125 | R50G | Samples |
| REF5010AIDGKT | ACTIVE | VSSOP | DGK | 8 | 250 | RoHS & Green | NIPDAU | Level-2-260C-1 YEAR | -40 to 125 | R50G | Samples |
| REF5010AIDR | ACTIVE | SOIC | D | 8 | 2500 | RoHS & Green | NIPDAU | Level-2-260C-1 YEAR | -40 to 125 | REF 5010 A | Samples |
| REF5010ID | ACTIVE | SOIC | D | 8 | 75 | RoHS & Green | Call TI | Level-2-260C-1 YEAR | -40 to 125 | REF 5010 | Samples |
| REF5010IDGKR | ACTIVE | VSSOP | DGK | 8 | 2500 | RoHS & Green | Call TI | Level-2-260C-1 YEAR | -40 to 125 | R50G | Samples |
| REF5010IDGKT | ACTIVE | VSSOP | DGK | 8 | 250 | RoHS & Green | Call TI | Level-2-260C-1 YEAR | -40 to 125 | R50G | Samples |
| REF5020AID | ACTIVE | SOIC | D | 8 | 75 | RoHS & Green | Call TI | Level-2-260C-1 YEAR | -40 to 125 | REF 5020 A | Samples |
| REF5020AIDGKR | ACTIVE | VSSOP | DGK | 8 | 2500 | RoHS & Green | NIPDAU | Level-2-260C-1 YEAR | -40 to 125 | R50A | Samples |
| REF5020AIDGKT | ACTIVE | VSSOP | DGK | 8 | 250 | RoHS & Green | Call TI | Level-2-260C-1 YEAR | -40 to 125 | R50A | Samples |
| REF5020AIDR | ACTIVE | SOIC | D | 8 | 2500 | RoHS & Green | NIPDAU | Level-2-260C-1 YEAR | -40 to 125 | REF 5020 A | Samples |
| REF5020ID | ACTIVE | SOIC | D | 8 | 75 | RoHS & Green | Call TI | Level-2-260C-1 YEAR | -40 to 125 | REF 5020 | Samples |
| REF5020IDGKR | ACTIVE | VSSOP | DGK | 8 | 2500 | RoHS & Green | Call TI | Level-2-260C-1 YEAR | -40 to 125 | R50A | Samples |
| REF5020IDGKT | ACTIVE | VSSOP | DGK | 8 | 250 | RoHS & Green | Call TI | Level-2-260C-1 YEAR | -40 to 125 | R50A | Samples |
| REF5020IDR | ACTIVE | SOIC | D | 8 | 2500 | RoHS & Green | Call TI | Level-2-260C-1 YEAR | -40 to 125 | REF 5020 | Samples |
| REF5025AID | ACTIVE | SOIC | D | 8 | 75 | RoHS & Green | Call TI | Level-2-260C-1 YEAR | -40 to 125 | REF 5025 A | Samples |

| Orderable Device | Status (1) | Package Type | Package Drawing | Pins | Package Qty | Eco Plan (2) | Lead finish/ Ball material (6) | MSL Peak Temp (3) | Op Temp (°C) | Device Marking (4/5) | Samples |
|------------------|---------------|--------------|-----------------|------|-------------|-----------------|--------------------------------------|----------------------|--------------|-------------------------|-------------------------|
| REF5025AIDGKR | ACTIVE | VSSOP | DGK | 8 | 2500 | RoHS & Green | NIPDAU | Level-2-260C-1 YEAR | -40 to 125 | R50B | Samples |
| REF5025AIDGKT | ACTIVE | VSSOP | DGK | 8 | 250 | RoHS & Green | NIPDAU | Level-2-260C-1 YEAR | -40 to 125 | R50B | Samples |
| REF5025AIDR | ACTIVE | SOIC | D | 8 | 2500 | RoHS & Green | NIPDAU | Level-2-260C-1 YEAR | -40 to 125 | REF 5025 A | Samples |
| REF5025ID | ACTIVE | SOIC | D | 8 | 75 | RoHS & Green | Call TI | Level-2-260C-1 YEAR | -40 to 125 | REF 5025 | Samples |
| REF5025IDGKR | ACTIVE | VSSOP | DGK | 8 | 2500 | RoHS & Green | Call TI | Level-2-260C-1 YEAR | -40 to 125 | R50B | Samples |
| REF5025IDGKT | ACTIVE | VSSOP | DGK | 8 | 250 | RoHS & Green | Call TI | Level-2-260C-1 YEAR | -40 to 125 | R50B | Samples |
| REF5025IDR | ACTIVE | SOIC | D | 8 | 2500 | RoHS & Green | Call TI | Level-2-260C-1 YEAR | -40 to 125 | REF 5025 | Samples |
| REF5030AID | ACTIVE | SOIC | D | 8 | 75 | RoHS & Green | Call TI | Level-2-260C-1 YEAR | -40 to 125 | REF 5030 A | Samples |
| REF5030AIDGKR | ACTIVE | VSSOP | DGK | 8 | 2500 | RoHS & Green | NIPDAU | Level-2-260C-1 YEAR | -40 to 125 | R50C | Samples |
| REF5030AIDGKT | ACTIVE | VSSOP | DGK | 8 | 250 | RoHS & Green | Call TI | Level-2-260C-1 YEAR | -40 to 125 | R50C | Samples |
| REF5030AIDR | ACTIVE | SOIC | D | 8 | 2500 | RoHS & Green | NIPDAU | Level-2-260C-1 YEAR | -40 to 125 | REF 5030 A | Samples |
| REF5030ID | ACTIVE | SOIC | D | 8 | 75 | RoHS & Green | Call TI | Level-2-260C-1 YEAR | -40 to 125 | REF 5030 | Samples |
| REF5030IDGKR | ACTIVE | VSSOP | DGK | 8 | 2500 | RoHS & Green | Call TI | Level-2-260C-1 YEAR | -40 to 125 | R50C | Samples |
| REF5030IDGKT | ACTIVE | VSSOP | DGK | 8 | 250 | RoHS & Green | Call TI | Level-2-260C-1 YEAR | -40 to 125 | R50C | Samples |
| REF5030IDR | ACTIVE | SOIC | D | 8 | 2500 | RoHS & Green | Call TI | Level-2-260C-1 YEAR | -40 to 125 | REF 5030 | Samples |
| REF5040AID | ACTIVE | SOIC | D | 8 | 75 | RoHS & Green | Call TI | Level-2-260C-1 YEAR | -40 to 125 | REF 5040 A | Samples |
| REF5040AIDGKR | ACTIVE | VSSOP | DGK | 8 | 2500 | RoHS & Green | NIPDAU | Level-2-260C-1 YEAR | -40 to 125 | R50D | Samples |

| Orderable Device | Status (1) | Package Type | Package Drawing | Pins | Package Qty | Eco Plan (2) | Lead finish/ Ball material (6) | MSL Peak Temp (3) | Op Temp (°C) | Device Marking (4/5) | Samples |
|------------------|---------------|--------------|-----------------|------|-------------|-----------------|--------------------------------------|----------------------|--------------|-------------------------|-------------------------|
| REF5040AIDGKT | ACTIVE | VSSOP | DGK | 8 | 250 | RoHS & Green | NIPDAU | Level-2-260C-1 YEAR | -40 to 125 | R50D | Samples |
| REF5040AIDR | ACTIVE | SOIC | D | 8 | 2500 | RoHS & Green | NIPDAU | Level-2-260C-1 YEAR | -40 to 125 | REF 5040 A | Samples |
| REF5040ID | ACTIVE | SOIC | D | 8 | 75 | RoHS & Green | Call TI | Level-2-260C-1 YEAR | -40 to 125 | REF 5040 | Samples |
| REF5040IDGKR | ACTIVE | VSSOP | DGK | 8 | 2500 | RoHS & Green | Call TI | Level-2-260C-1 YEAR | -40 to 125 | R50D | Samples |
| REF5040IDGKT | ACTIVE | VSSOP | DGK | 8 | 250 | RoHS & Green | Call TI | Level-2-260C-1 YEAR | -40 to 125 | R50D | Samples |
| REF5040IDR | ACTIVE | SOIC | D | 8 | 2500 | RoHS & Green | Call TI | Level-2-260C-1 YEAR | -40 to 125 | REF 5040 | Samples |
| REF5045AID | ACTIVE | SOIC | D | 8 | 75 | RoHS & Green | Call TI | Level-2-260C-1 YEAR | -40 to 125 | REF 5045 A | Samples |
| REF5045AIDGKR | ACTIVE | VSSOP | DGK | 8 | 2500 | RoHS & Green | NIPDAU | Level-2-260C-1 YEAR | -40 to 125 | R50E | Samples |
| REF5045AIDGKT | ACTIVE | VSSOP | DGK | 8 | 250 | RoHS & Green | NIPDAU | Level-2-260C-1 YEAR | -40 to 125 | R50E | Samples |
| REF5045AIDR | ACTIVE | SOIC | D | 8 | 2500 | RoHS & Green | NIPDAU | Level-2-260C-1 YEAR | -40 to 125 | REF 5045 A | Samples |
| REF5045ID | ACTIVE | SOIC | D | 8 | 75 | RoHS & Green | Call TI | Level-2-260C-1 YEAR | -40 to 125 | REF 5045 | Samples |
| REF5045IDGKR | ACTIVE | VSSOP | DGK | 8 | 2500 | RoHS & Green | Call TI | Level-2-260C-1 YEAR | -40 to 125 | R50E | Samples |
| REF5045IDGKT | ACTIVE | VSSOP | DGK | 8 | 250 | RoHS & Green | Call TI | Level-2-260C-1 YEAR | -40 to 125 | R50E | Samples |
| REF5045IDR | ACTIVE | SOIC | D | 8 | 2500 | RoHS & Green | Call TI | Level-2-260C-1 YEAR | -40 to 125 | REF 5045 | Samples |
| REF5050AID | ACTIVE | SOIC | D | 8 | 75 | RoHS & Green | Call TI | Level-2-260C-1 YEAR | -40 to 125 | REF 5050 A | Samples |
| REF5050AIDGKR | ACTIVE | VSSOP | DGK | 8 | 2500 | RoHS & Green | Call TI NIPDAU | Level-2-260C-1 YEAR | -40 to 125 | R50F | Samples |
| REF5050AIDGKT | ACTIVE | VSSOP | DGK | 8 | 250 | RoHS & Green | NIPDAU | Level-2-260C-1 YEAR | -40 to 125 | R50F | Samples |

| Orderable Device | Status (1) | Package Type | Package Drawing | Pins | Package Qty | Eco Plan (2) | Lead finish/ Ball material (6) | MSL Peak Temp (3) | Op Temp (°C) | Device Marking (4/5) | Samples |
|------------------|---------------|--------------|-----------------|------|-------------|-----------------|--------------------------------------|----------------------|--------------|-------------------------|-------------------------|
| REF5050AIDR | ACTIVE | SOIC | D | 8 | 2500 | RoHS & Green | NIPDAU | Level-2-260C-1 YEAR | -40 to 125 | REF 5050 A | Samples |
| REF5050ID | ACTIVE | SOIC | D | 8 | 75 | RoHS & Green | Call TI | Level-2-260C-1 YEAR | -40 to 125 | REF 5050 | Samples |
| REF5050IDGKR | ACTIVE | VSSOP | DGK | 8 | 2500 | RoHS & Green | Call TI | Level-2-260C-1 YEAR | -40 to 125 | R50F | Samples |
| REF5050IDGKT | ACTIVE | VSSOP | DGK | 8 | 250 | RoHS & Green | Call TI | Level-2-260C-1 YEAR | -40 to 125 | R50F | Samples |
| REF5050IDR | ACTIVE | SOIC | D | 8 | 2500 | RoHS & Green | Call TI | Level-2-260C-1 YEAR | -40 to 125 | REF 5050 | Samples |

(1) The marketing status values are defined as follows:

ACTIVE: Product device recommended for new designs.

LIFEBUY: TI has announced that the device will be discontinued, and a lifetime-buy period is in effect.

NRND: Not recommended for new designs. Device is in production to support existing customers, but TI does not recommend using this part in a new design.

PREVIEW: Device has been announced but is not in production. Samples may or may not be available.

OBSELETE: TI has discontinued the production of the device.

(2) **RoHS:** TI defines "RoHS" to mean semiconductor products that are compliant with the current EU RoHS requirements for all 10 RoHS substances, including the requirement that RoHS substance do not exceed 0.1% by weight in homogeneous materials. Where designed to be soldered at high temperatures, "RoHS" products are suitable for use in specified lead-free processes. TI may reference these types of products as "Pb-Free".

RoHS Exempt: TI defines "RoHS Exempt" to mean products that contain lead but are compliant with EU RoHS pursuant to a specific EU RoHS exemption.

Green: TI defines "Green" to mean the content of Chlorine (Cl) and Bromine (Br) based flame retardants meet JS709B low halogen requirements of <=1000ppm threshold. Antimony trioxide based flame retardants must also meet the <=1000ppm threshold requirement.

(3) MSL, Peak Temp. - The Moisture Sensitivity Level rating according to the JEDEC industry standard classifications, and peak solder temperature.

(4) There may be additional marking, which relates to the logo, the lot trace code information, or the environmental category on the device.

(5) Multiple Device Markings will be inside parentheses. Only one Device Marking contained in parentheses and separated by a "~" will appear on a device. If a line is indented then it is a continuation of the previous line and the two combined represent the entire Device Marking for that device.

(6) Lead finish/Ball material - Orderable Devices may have multiple material finish options. Finish options are separated by a vertical ruled line. Lead finish/Ball material values may wrap to two lines if the finish value exceeds the maximum column width.

Important Information and Disclaimer: The information provided on this page represents TI's knowledge and belief as of the date that it is provided. TI bases its knowledge and belief on information provided by third parties, and makes no representation or warranty as to the accuracy of such information. Efforts are underway to better integrate information from third parties. TI has taken and continues to take reasonable steps to provide representative and accurate information but may not have conducted destructive testing or chemical analysis on incoming materials and chemicals. TI and TI suppliers consider certain information to be proprietary, and thus CAS numbers and other limited information may not be available for release.

In no event shall TI's liability arising out of such information exceed the total purchase price of the TI part(s) at issue in this document sold by TI to Customer on an annual basis.

OTHER QUALIFIED VERSIONS OF REF5020, REF5025, REF5040, REF5050 :

- Enhanced Product : [REF5020-EP](#), [REF5025-EP](#), [REF5040-EP](#), [REF5050-EP](#)

NOTE: Qualified Version Definitions:

- Enhanced Product - Supports Defense, Aerospace and Medical Applications

TAPE AND REEL INFORMATION

QUADRANT ASSIGNMENTS FOR PIN 1 ORIENTATION IN TAPE

*All dimensions are nominal

| Device | Package Type | Package Drawing | Pins | SPQ | Reel Diameter (mm) | Reel Width W1 (mm) | A0 (mm) | B0 (mm) | K0 (mm) | P1 (mm) | W (mm) | Pin1 Quadrant |
|---------------|--------------|-----------------|------|------|--------------------|--------------------|---------|---------|---------|---------|--------|---------------|
| REF5010AIDGKR | VSSOP | DGK | 8 | 2500 | 330.0 | 12.4 | 5.3 | 3.4 | 1.4 | 8.0 | 12.0 | Q1 |
| REF5010AIDGKT | VSSOP | DGK | 8 | 250 | 180.0 | 12.4 | 5.3 | 3.4 | 1.4 | 8.0 | 12.0 | Q1 |
| REF5010AIDR | SOIC | D | 8 | 2500 | 330.0 | 12.4 | 6.4 | 5.2 | 2.1 | 8.0 | 12.0 | Q1 |
| REF5010IDGKR | VSSOP | DGK | 8 | 2500 | 330.0 | 12.4 | 5.3 | 3.4 | 1.4 | 8.0 | 12.0 | Q1 |
| REF5010IDGKT | VSSOP | DGK | 8 | 250 | 180.0 | 12.4 | 5.3 | 3.4 | 1.4 | 8.0 | 12.0 | Q1 |
| REF5020AIDGKR | VSSOP | DGK | 8 | 2500 | 330.0 | 12.4 | 5.3 | 3.4 | 1.4 | 8.0 | 12.0 | Q1 |
| REF5020AIDGKT | VSSOP | DGK | 8 | 250 | 180.0 | 12.4 | 5.3 | 3.4 | 1.4 | 8.0 | 12.0 | Q1 |
| REF5020AIDR | SOIC | D | 8 | 2500 | 330.0 | 12.4 | 6.4 | 5.2 | 2.1 | 8.0 | 12.0 | Q1 |
| REF5020IDGKR | VSSOP | DGK | 8 | 2500 | 330.0 | 12.4 | 5.3 | 3.4 | 1.4 | 8.0 | 12.0 | Q1 |
| REF5020IDGKT | VSSOP | DGK | 8 | 250 | 180.0 | 12.4 | 5.3 | 3.4 | 1.4 | 8.0 | 12.0 | Q1 |
| REF5020IDR | SOIC | D | 8 | 2500 | 330.0 | 12.4 | 6.4 | 5.2 | 2.1 | 8.0 | 12.0 | Q1 |
| REF5025AIDGKR | VSSOP | DGK | 8 | 2500 | 330.0 | 12.4 | 5.3 | 3.4 | 1.4 | 8.0 | 12.0 | Q1 |
| REF5025AIDGKT | VSSOP | DGK | 8 | 250 | 180.0 | 12.4 | 5.3 | 3.4 | 1.4 | 8.0 | 12.0 | Q1 |
| REF5025AIDR | SOIC | D | 8 | 2500 | 330.0 | 12.4 | 6.4 | 5.2 | 2.1 | 8.0 | 12.0 | Q1 |
| REF5025IDGKR | VSSOP | DGK | 8 | 2500 | 330.0 | 12.4 | 5.3 | 3.4 | 1.4 | 8.0 | 12.0 | Q1 |
| REF5025IDGKT | VSSOP | DGK | 8 | 250 | 180.0 | 12.4 | 5.3 | 3.4 | 1.4 | 8.0 | 12.0 | Q1 |

| Device | Package Type | Package Drawing | Pins | SPQ | Reel Diameter (mm) | Reel Width W1 (mm) | A0 (mm) | B0 (mm) | K0 (mm) | P1 (mm) | W (mm) | Pin1 Quadrant |
|---------------|--------------|-----------------|------|------|--------------------|--------------------|---------|---------|---------|---------|--------|---------------|
| REF5025IDR | SOIC | D | 8 | 2500 | 330.0 | 12.4 | 6.4 | 5.2 | 2.1 | 8.0 | 12.0 | Q1 |
| REF5030AIDGKR | VSSOP | DGK | 8 | 2500 | 330.0 | 12.4 | 5.3 | 3.4 | 1.4 | 8.0 | 12.0 | Q1 |
| REF5030AIDGKT | VSSOP | DGK | 8 | 250 | 180.0 | 12.4 | 5.3 | 3.4 | 1.4 | 8.0 | 12.0 | Q1 |
| REF5030AIDR | SOIC | D | 8 | 2500 | 330.0 | 12.4 | 6.4 | 5.2 | 2.1 | 8.0 | 12.0 | Q1 |
| REF5030IDGKR | VSSOP | DGK | 8 | 2500 | 330.0 | 12.4 | 5.3 | 3.4 | 1.4 | 8.0 | 12.0 | Q1 |
| REF5030IDGKT | VSSOP | DGK | 8 | 250 | 180.0 | 12.4 | 5.3 | 3.4 | 1.4 | 8.0 | 12.0 | Q1 |
| REF5030IDR | SOIC | D | 8 | 2500 | 330.0 | 12.4 | 6.4 | 5.2 | 2.1 | 8.0 | 12.0 | Q1 |
| REF5040AIDGKR | VSSOP | DGK | 8 | 2500 | 330.0 | 12.4 | 5.3 | 3.4 | 1.4 | 8.0 | 12.0 | Q1 |
| REF5040AIDGKT | VSSOP | DGK | 8 | 250 | 180.0 | 12.4 | 5.3 | 3.4 | 1.4 | 8.0 | 12.0 | Q1 |
| REF5040AIDR | SOIC | D | 8 | 2500 | 330.0 | 12.4 | 6.4 | 5.2 | 2.1 | 8.0 | 12.0 | Q1 |
| REF5040IDGKR | VSSOP | DGK | 8 | 2500 | 330.0 | 12.4 | 5.3 | 3.4 | 1.4 | 8.0 | 12.0 | Q1 |
| REF5040IDGKT | VSSOP | DGK | 8 | 250 | 180.0 | 12.4 | 5.3 | 3.4 | 1.4 | 8.0 | 12.0 | Q1 |
| REF5040IDR | SOIC | D | 8 | 2500 | 330.0 | 12.4 | 6.4 | 5.2 | 2.1 | 8.0 | 12.0 | Q1 |
| REF5045AIDGKR | VSSOP | DGK | 8 | 2500 | 330.0 | 12.4 | 5.3 | 3.4 | 1.4 | 8.0 | 12.0 | Q1 |
| REF5045AIDGKT | VSSOP | DGK | 8 | 250 | 180.0 | 12.4 | 5.3 | 3.4 | 1.4 | 8.0 | 12.0 | Q1 |
| REF5045AIDR | SOIC | D | 8 | 2500 | 330.0 | 12.4 | 6.4 | 5.2 | 2.1 | 8.0 | 12.0 | Q1 |
| REF5045IDGKR | VSSOP | DGK | 8 | 2500 | 330.0 | 12.4 | 5.3 | 3.4 | 1.4 | 8.0 | 12.0 | Q1 |
| REF5045IDGKT | VSSOP | DGK | 8 | 250 | 180.0 | 12.4 | 5.3 | 3.4 | 1.4 | 8.0 | 12.0 | Q1 |
| REF5045IDR | SOIC | D | 8 | 2500 | 330.0 | 12.4 | 6.4 | 5.2 | 2.1 | 8.0 | 12.0 | Q1 |
| REF5050AIDGKR | VSSOP | DGK | 8 | 2500 | 330.0 | 12.4 | 5.3 | 3.4 | 1.4 | 8.0 | 12.0 | Q1 |
| REF5050AIDGKT | VSSOP | DGK | 8 | 250 | 180.0 | 12.4 | 5.3 | 3.4 | 1.4 | 8.0 | 12.0 | Q1 |
| REF5050AIDR | SOIC | D | 8 | 2500 | 330.0 | 12.4 | 6.4 | 5.2 | 2.1 | 8.0 | 12.0 | Q1 |
| REF5050IDGKR | VSSOP | DGK | 8 | 2500 | 330.0 | 12.4 | 5.3 | 3.4 | 1.4 | 8.0 | 12.0 | Q1 |
| REF5050IDGKT | VSSOP | DGK | 8 | 250 | 180.0 | 12.4 | 5.3 | 3.4 | 1.4 | 8.0 | 12.0 | Q1 |
| REF5050IDR | SOIC | D | 8 | 2500 | 330.0 | 12.4 | 6.4 | 5.2 | 2.1 | 8.0 | 12.0 | Q1 |

TAPE AND REEL BOX DIMENSIONS



*All dimensions are nominal

| Device | Package Type | Package Drawing | Pins | SPQ | Length (mm) | Width (mm) | Height (mm) |
|---------------|--------------|-----------------|------|------|-------------|------------|-------------|
| REF5010AIDGKR | VSSOP | DGK | 8 | 2500 | 367.0 | 367.0 | 35.0 |
| REF5010AIDGKT | VSSOP | DGK | 8 | 250 | 210.0 | 185.0 | 35.0 |
| REF5010AIDR | SOIC | D | 8 | 2500 | 367.0 | 367.0 | 35.0 |
| REF5010IDGKR | VSSOP | DGK | 8 | 2500 | 356.0 | 356.0 | 35.0 |
| REF5010IDGKT | VSSOP | DGK | 8 | 250 | 210.0 | 185.0 | 35.0 |
| REF5020AIDGKR | VSSOP | DGK | 8 | 2500 | 367.0 | 367.0 | 35.0 |
| REF5020AIDGKT | VSSOP | DGK | 8 | 250 | 210.0 | 185.0 | 35.0 |
| REF5020AIDR | SOIC | D | 8 | 2500 | 367.0 | 367.0 | 35.0 |
| REF5020IDGKR | VSSOP | DGK | 8 | 2500 | 367.0 | 367.0 | 35.0 |
| REF5020IDGKT | VSSOP | DGK | 8 | 250 | 210.0 | 185.0 | 35.0 |
| REF5020IDR | SOIC | D | 8 | 2500 | 367.0 | 367.0 | 35.0 |
| REF5025AIDGKR | VSSOP | DGK | 8 | 2500 | 367.0 | 367.0 | 35.0 |
| REF5025AIDGKT | VSSOP | DGK | 8 | 250 | 210.0 | 185.0 | 35.0 |
| REF5025AIDR | SOIC | D | 8 | 2500 | 367.0 | 367.0 | 35.0 |
| REF5025IDGKR | VSSOP | DGK | 8 | 2500 | 367.0 | 367.0 | 35.0 |
| REF5025IDGKT | VSSOP | DGK | 8 | 250 | 210.0 | 185.0 | 35.0 |
| REF5025IDR | SOIC | D | 8 | 2500 | 367.0 | 367.0 | 35.0 |
| REF5030AIDGKR | VSSOP | DGK | 8 | 2500 | 367.0 | 367.0 | 35.0 |

| Device | Package Type | Package Drawing | Pins | SPQ | Length (mm) | Width (mm) | Height (mm) |
|---------------|--------------|-----------------|------|------|-------------|------------|-------------|
| REF5030AIDGKT | VSSOP | DGK | 8 | 250 | 210.0 | 185.0 | 35.0 |
| REF5030AIDR | SOIC | D | 8 | 2500 | 367.0 | 367.0 | 35.0 |
| REF5030IDGKR | VSSOP | DGK | 8 | 2500 | 367.0 | 367.0 | 35.0 |
| REF5030IDGKT | VSSOP | DGK | 8 | 250 | 210.0 | 185.0 | 35.0 |
| REF5030IDR | SOIC | D | 8 | 2500 | 367.0 | 367.0 | 35.0 |
| REF5040AIDGKR | VSSOP | DGK | 8 | 2500 | 367.0 | 367.0 | 35.0 |
| REF5040AIDGKT | VSSOP | DGK | 8 | 250 | 210.0 | 185.0 | 35.0 |
| REF5040AIDR | SOIC | D | 8 | 2500 | 367.0 | 367.0 | 35.0 |
| REF5040IDGKR | VSSOP | DGK | 8 | 2500 | 367.0 | 367.0 | 35.0 |
| REF5040IDGKT | VSSOP | DGK | 8 | 250 | 210.0 | 185.0 | 35.0 |
| REF5040IDR | SOIC | D | 8 | 2500 | 367.0 | 367.0 | 35.0 |
| REF5045AIDGKR | VSSOP | DGK | 8 | 2500 | 367.0 | 367.0 | 35.0 |
| REF5045AIDGKT | VSSOP | DGK | 8 | 250 | 210.0 | 185.0 | 35.0 |
| REF5045AIDR | SOIC | D | 8 | 2500 | 367.0 | 367.0 | 35.0 |
| REF5045IDGKR | VSSOP | DGK | 8 | 2500 | 367.0 | 367.0 | 35.0 |
| REF5045IDGKT | VSSOP | DGK | 8 | 250 | 210.0 | 185.0 | 35.0 |
| REF5045IDR | SOIC | D | 8 | 2500 | 356.0 | 356.0 | 35.0 |
| REF5050AIDGKR | VSSOP | DGK | 8 | 2500 | 356.0 | 356.0 | 35.0 |
| REF5050AIDGKT | VSSOP | DGK | 8 | 250 | 210.0 | 185.0 | 35.0 |
| REF5050AIDR | SOIC | D | 8 | 2500 | 356.0 | 356.0 | 35.0 |
| REF5050IDGKR | VSSOP | DGK | 8 | 2500 | 356.0 | 356.0 | 35.0 |
| REF5050IDGKT | VSSOP | DGK | 8 | 250 | 210.0 | 185.0 | 35.0 |
| REF5050IDR | SOIC | D | 8 | 2500 | 367.0 | 367.0 | 35.0 |

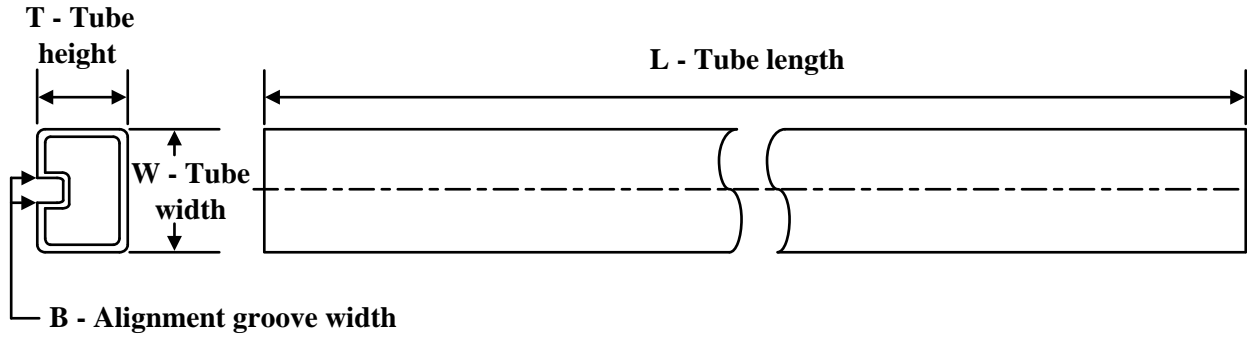
TUBE

*All dimensions are nominal

| Device | Package Name | Package Type | Pins | SPQ | L (mm) | W (mm) | T (μm) | B (mm) |
|------------|--------------|--------------|------|-----|--------|--------|--------|--------|
| REF5010AID | D | SOIC | 8 | 75 | 506.6 | 8 | 3940 | 4.32 |
| REF5010ID | D | SOIC | 8 | 75 | 506.6 | 8 | 3940 | 4.32 |
| REF5020AID | D | SOIC | 8 | 75 | 506.6 | 8 | 3940 | 4.32 |
| REF5020ID | D | SOIC | 8 | 75 | 506.6 | 8 | 3940 | 4.32 |
| REF5025AID | D | SOIC | 8 | 75 | 506.6 | 8 | 3940 | 4.32 |
| REF5025ID | D | SOIC | 8 | 75 | 506.6 | 8 | 3940 | 4.32 |
| REF5030AID | D | SOIC | 8 | 75 | 506.6 | 8 | 3940 | 4.32 |
| REF5030ID | D | SOIC | 8 | 75 | 506.6 | 8 | 3940 | 4.32 |
| REF5040AID | D | SOIC | 8 | 75 | 506.6 | 8 | 3940 | 4.32 |
| REF5040ID | D | SOIC | 8 | 75 | 506.6 | 8 | 3940 | 4.32 |
| REF5045AID | D | SOIC | 8 | 75 | 506.6 | 8 | 3940 | 4.32 |
| REF5045ID | D | SOIC | 8 | 75 | 506.6 | 8 | 3940 | 4.32 |
| REF5050AID | D | SOIC | 8 | 75 | 506.6 | 8 | 3940 | 4.32 |
| REF5050ID | D | SOIC | 8 | 75 | 506.6 | 8 | 3940 | 4.32 |

DGK0008A



PACKAGE OUTLINE

VSSOP - 1.1 mm max height

SMALL OUTLINE PACKAGE



NOTES:

PowerPAD is a trademark of Texas Instruments.

1. All linear dimensions are in millimeters. Any dimensions in parenthesis are for reference only. Dimensioning and tolerancing per ASME Y14.5M.
2. This drawing is subject to change without notice.
3. This dimension does not include mold flash, protrusions, or gate burrs. Mold flash, protrusions, or gate burrs shall not exceed 0.15 mm per side.
4. This dimension does not include interlead flash. Interlead flash shall not exceed 0.25 mm per side.
5. Reference JEDEC registration MO-187.

EXAMPLE BOARD LAYOUT

DGK0008A

™ VSSOP - 1.1 mm max height

SMALL OUTLINE PACKAGE



LAND PATTERN EXAMPLE
EXPOSED METAL SHOWN
SCALE: 15X



SOLDER MASK DETAILS

4214862/A 04/2023

NOTES: (continued)

6. Publication IPC-7351 may have alternate designs.
7. Solder mask tolerances between and around signal pads can vary based on board fabrication site.
8. Vias are optional depending on application, refer to device data sheet. If any vias are implemented, refer to their locations shown on this view. It is recommended that vias under paste be filled, plugged or tented.
9. Size of metal pad may vary due to creepage requirement.

EXAMPLE STENCIL DESIGN

DGK0008A

TM VSSOP - 1.1 mm max height

SMALL OUTLINE PACKAGE

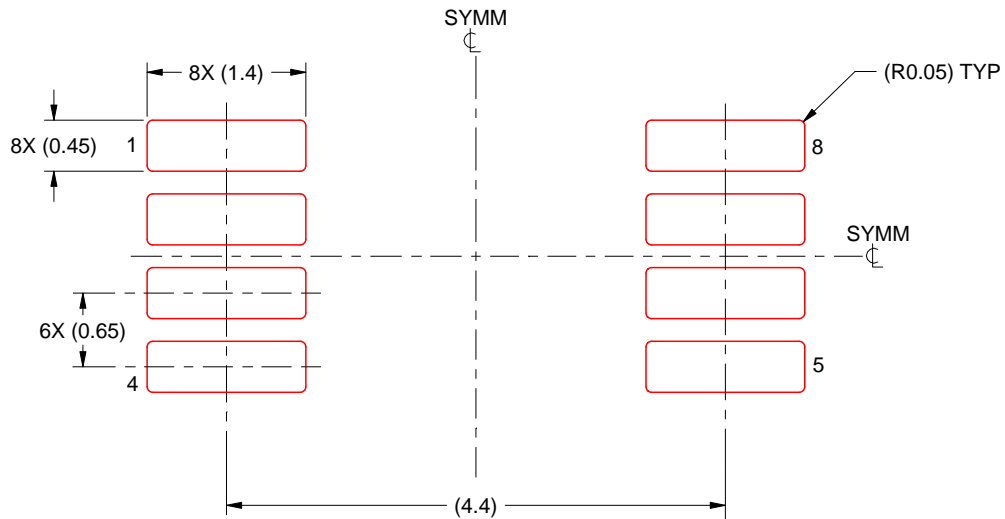

SOLDER PASTE EXAMPLE
SCALE: 15X

4214862/A 04/2023

NOTES: (continued)

11. Laser cutting apertures with trapezoidal walls and rounded corners may offer better paste release. IPC-7525 may have alternate design recommendations.
12. Board assembly site may have different recommendations for stencil design.



D0008A

PACKAGE OUTLINE

SOIC - 1.75 mm max height

SMALL OUTLINE INTEGRATED CIRCUIT



4214825/C 02/2019

NOTES:

- Linear dimensions are in inches [millimeters]. Dimensions in parenthesis are for reference only. Controlling dimensions are in inches. Dimensioning and tolerancing per ASME Y14.5M.
- This drawing is subject to change without notice.
- This dimension does not include mold flash, protrusions, or gate burrs. Mold flash, protrusions, or gate burrs shall not exceed $.006$ [0.15] per side.
- This dimension does not include interlead flash.
- Reference JEDEC registration MS-012, variation AA.

EXAMPLE BOARD LAYOUT

D0008A

SOIC - 1.75 mm max height

SMALL OUTLINE INTEGRATED CIRCUIT



LAND PATTERN EXAMPLE
 EXPOSED METAL SHOWN
 SCALE:8X



SOLDER MASK DETAILS

4214825/C 02/2019

NOTES: (continued)

- 6. Publication IPC-7351 may have alternate designs.
- 7. Solder mask tolerances between and around signal pads can vary based on board fabrication site.

EXAMPLE STENCIL DESIGN

D0008A

SOIC - 1.75 mm max height

SMALL OUTLINE INTEGRATED CIRCUIT



SOLDER PASTE EXAMPLE
BASED ON .005 INCH [0.125 MM] THICK STENCIL
SCALE:8X

4214825/C 02/2019

NOTES: (continued)

8. Laser cutting apertures with trapezoidal walls and rounded corners may offer better paste release. IPC-7525 may have alternate design recommendations.
9. Board assembly site may have different recommendations for stencil design.

IMPORTANT NOTICE AND DISCLAIMER

TI PROVIDES TECHNICAL AND RELIABILITY DATA (INCLUDING DATA SHEETS), DESIGN RESOURCES (INCLUDING REFERENCE DESIGNS), APPLICATION OR OTHER DESIGN ADVICE, WEB TOOLS, SAFETY INFORMATION, AND OTHER RESOURCES "AS IS" AND WITH ALL FAULTS, AND DISCLAIMS ALL WARRANTIES, EXPRESS AND IMPLIED, INCLUDING WITHOUT LIMITATION ANY IMPLIED WARRANTIES OF MERCHANTABILITY, FITNESS FOR A PARTICULAR PURPOSE OR NON-INFRINGEMENT OF THIRD PARTY INTELLECTUAL PROPERTY RIGHTS.

These resources are intended for skilled developers designing with TI products. You are solely responsible for (1) selecting the appropriate TI products for your application, (2) designing, validating and testing your application, and (3) ensuring your application meets applicable standards, and any other safety, security, regulatory or other requirements.

These resources are subject to change without notice. TI grants you permission to use these resources only for development of an application that uses the TI products described in the resource. Other reproduction and display of these resources is prohibited. No license is granted to any other TI intellectual property right or to any third party intellectual property right. TI disclaims responsibility for, and you will fully indemnify TI and its representatives against, any claims, damages, costs, losses, and liabilities arising out of your use of these resources.

TI's products are provided subject to [TI's Terms of Sale](#) or other applicable terms available either on [ti.com](https://www.ti.com) or provided in conjunction with such TI products. TI's provision of these resources does not expand or otherwise alter TI's applicable warranties or warranty disclaimers for TI products.

TI objects to and rejects any additional or different terms you may have proposed.

Mailing Address: Texas Instruments, Post Office Box 655303, Dallas, Texas 75265
Copyright © 2024, Texas Instruments Incorporated

Looking for pricing, stock, or lifecycle information?

Click below to explore more details on WIN SOURCE:

 [View REF5045AIDGKR on WIN SOURCE](#)

 [Texas Instruments](#) Information

Optimize Your Supply Chain with WIN SOURCE Solutions

-  Global Sourcing Solution
-  Obsolete Management
-  Cost Control Management
-  Shortage Management
-  Alternative Solution
-  Excess Inventory Management