



**THE DATASHEET OF
RB520G-30-TP**





RB520G-30

100 mA
Schottky Barrier Diode
30 Volts

Features

- Halogen free available upon request by adding suffix "-HF"
- Lead Free Finish/RoHS Compliant("P" Suffix designates RoHS Compliant. See ordering information)
- Epoxy meets UL 94 V-0 flammability rating
- Moisture Sensitivity Level 1
- Marking : E
- High Reliability
- Low Reverse Current and Low Forward Voltage.
- Small Surface Mount Type

SOD-723

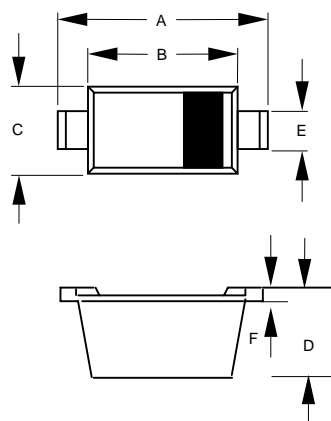

Maximum Ratings

Symbol	Rating	Rating	Unit
V _R	DC Reverse Voltage	30	V
I _O	Mean Rectifying Current	100	mA
I _{FSM}	Peak Forward Surge Current*	0.5	A
T _J	Junction Temperature	125	°C
T _{STG}	Storage Temperature	-40 to +125	°C

Electrical Characteristics @ 25°C Unless Otherwise Specified

Symbol	Parameter	Min	Typ	Max	Units
V _F	Forward Voltage (I _F =10mA _{dc})	---	---	0.45	V _{dc}
I _R	Reverse Current (V _R =10V _{dc})	---	---	0.5	μA _{dc}

DIM	DIMENSIONS				NOTE
	INCHES		MM		
	MIN	MAX	MIN	MAX	
A	.051	.059	1.30	1.50	
B	.035	.043	0.90	1.10	
C	.022	.026	0.55	0.65	
D	.021	.026	0.525	0.65	
E	.010	.014	0.25	0.35	
F	.003	.006	0.08	0.15	

●Electrical characteristic curves (Ta=25°C)

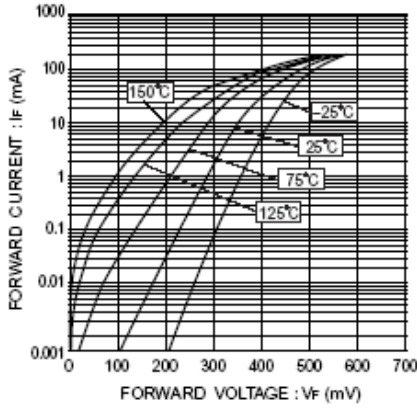

Fig.1 Forward characteristics

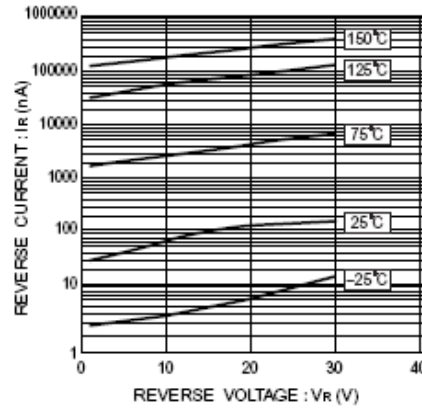

Fig.2 Reverse characteristics

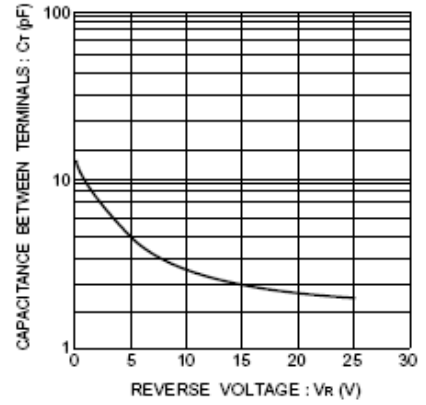

Fig. 3 Capacitance between terminals characteristics



TM

Micro Commercial Components

Ordering Information :

Device	Packing
Part Number-TP	Tape&Reel: 8Kpcs/Reel

Note : Adding "-HF" suffix for halogen free, eg. Part Number-TP-HF

IMPORTANT NOTICE

Micro Commercial Components Corp. reserves the right to make changes without further notice to any product herein to make corrections, modifications , enhancements , improvements , or other changes . **Micro Commercial Components Corp .** does not assume any liability arising out of the application or use of any product described herein; neither does it convey any license under its patent rights ,nor the rights of others . The user of products in such applications shall assume all risks of such use and will agree to hold **Micro Commercial Components Corp .** and all the companies whose products are represented on our website, harmless against all damages.

LIFE SUPPORT

MCC's products are not authorized for use as critical components in life support devices or systems without the express written approval of Micro Commercial Components Corporation.



CUSTOMER AWARENESS

Counterfeiting of semiconductor parts is a growing problem in the industry. Micro Commercial Components (MCC) is taking strong measures to protect ourselves and our customers from the proliferation of counterfeit parts. MCC strongly encourages customers to purchase MCC parts either directly from MCC or from Authorized MCC Distributors who are listed by country on our web page cited below. Products customers buy either from MCC directly or from Authorized MCC Distributors are genuine parts, have full traceability, meet MCC's quality standards for handling and storage. **MCC will not provide any warranty coverage or other assistance for parts bought from Unauthorized Sources.** MCC is committed to combat this global problem and encourage our customers to do their part in stopping this practice by buying direct or from authorized distributors.





www.mccsemi.com

Looking for pricing, stock, or lifecycle information?

Click below to explore more details on WIN SOURCE:

-  [View RB520G-30-TP on WIN SOURCE](#)
-  [Micro Commercial Co](#) Information

Optimize Your Supply Chain with WIN SOURCE Solutions

-  Global Sourcing Solution
-  Obsolete Management
-  Cost Control Management
-  Shortage Management
-  Alternative Solution
-  Excess Inventory Management