

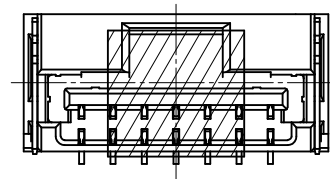

**THE DATASHEET OF**  
**5023820670**

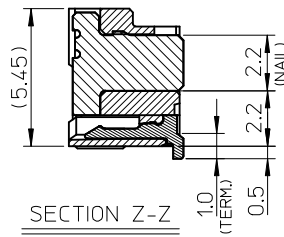

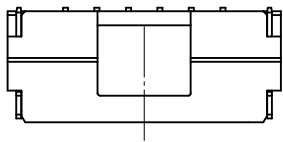

カプトンテープ付き  
WITH KAPTON TAPE

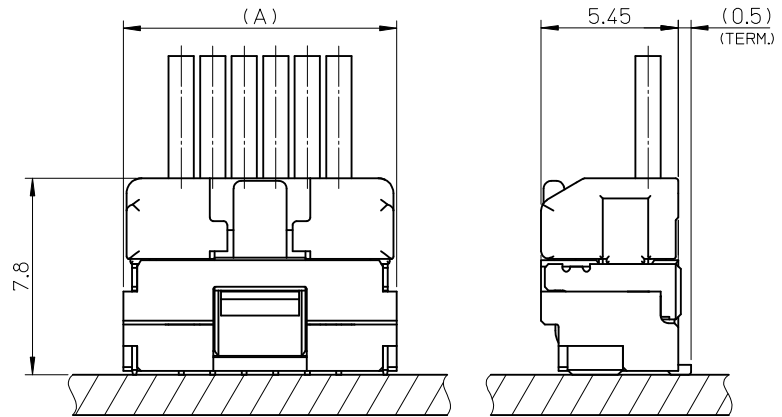
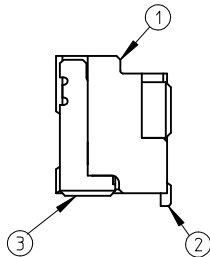
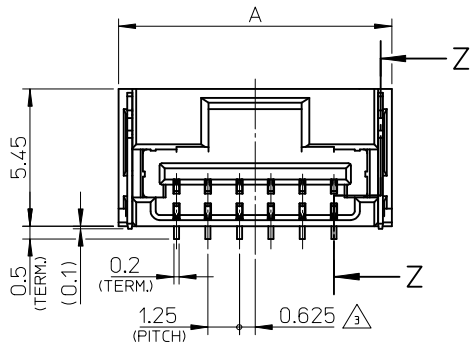

嵌合図  
MATED CONNECTORS

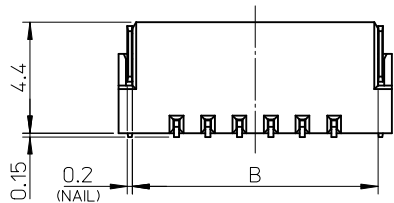

NOTES

- 嵌合相手: 502380-\*\*\*\*  
MATE WITH: 502380-\*\*\*\*
- 端子テール部 及び ネイルの平坦度: 0.1MAX.  
TAIL AND NAIL COPLANARITY TO BE 0.1 MAX.
- 極数/2=偶数に適用。  
APPLY FOR CKT. SIZE / 2 = EVEN.
- 端子テール部 及び ネイルに錫めっきを使用しているため、  
外観に摺動痕が付く場合が御座います。  
THE WOUND OF FRICTION MIGHT ADHERE TO EXTERNALS  
BECAUSE THE TIN PLATING IS USED FOR THE TAIL AND NAIL.
- 本製品のプラスチック部に黒点等が確認される場合や  
色合いが異なる場合がありますが、製品性能に影響はありません。  
THERE IS NO INFLUENCE IN THE PRODUCT PERFORMANCE THOUGH  
THE BLACK SPOT ETC. MIGHT BE CONFIRMED TO THE PLASTIC PART  
OF THIS PRODUCT AND THE SHADE MIGHT BE DIFFERENT.
- ELV及びRoHS適合品  
ELV AND RoHS COMPLIANT

3.4	7.5	11	12.1	502382-07**	7
3.4	6.25	9.75	10.85	502382-06**	6
3.4	5	8.5	9.6	502382-05**	5
3.4	3.75	7.25	8.35	502382-04**	4
2.7	2.5	6	7.1	502382-03**	3
2.3	1.25	4.75	5.85	502382-02**	2
D	C	B	A	EMBOSSED TAPE PACKAGE オーダー番号 ORDER No.	極数 CKT. NO.

番号 NO.	部品 PART	材質 MATERIAL
①	ハウジング HOUSING	耐熱性樹脂 UL94V-0 色:SHEET 3 参照 HEATPROOF RESIN UL94V-0 COLOR : SEE SHEET 3
②	ターミナル TERMINAL	銅合金 COPPER ALLOY 錫めっき: 1.0 micro-meter MIN. TIN (TAIL AREA) ニッケルめっき(下地): 1.0 micro-meter MIN. NICKEL (UNDER PLATING)
③	ネイル NAIL	銅合金 COPPER ALLOY 錫めっき: 1.0 micro-meter MIN. TIN ニッケルめっき(下地): 1.0 micro-meter MIN. NICKEL (UNDER PLATING)

REVISED EC NO: J2013-1131 DRWN: SAT002 CHKD: KASAKAWA APPR: Y0 ITO	DESCRIPTION 2013/04/08 2013/04/08 2013/04/08	GENERAL TOLERANCES (UNLESS SPECIFIED)		DIMENSION STYLE MM ONLY		SCALE 5:1	DESIGN UNITS METRIC	THIRD ANGLE PROJECTION	
		10 UNDER	±0.2	DRAWN BY T. MIYAZAKI	DATE 2006/08/28	TITLE 1.25 W/B CONN. SINGLE S/T REC. ASS'Y 2-7CKT.			
		10 OVER 30 UNDER	±0.25	CHECKED BY K. ASAKAWA	DATE 2006/08/28				
		30 OVER	±0.3	APPROVED BY Y0. ITO	DATE 2006/08/28				
ANGULAR ±3 ° DRAFT WHERE APPLICABLE MUST REMAIN WITHIN DIMENSIONS		SIZE A3	MATERIAL NO. SEE TABLE			DOCUMENT NO. SD-502382-001		SHEET NO. 1 OF 3	
THIS DRAWING CONTAINS INFORMATION THAT IS PROPRIETARY TO MOLEX INCORPORATED AND SHOULD NOT BE USED WITHOUT WRITTEN PERMISSION									



2 CKT.

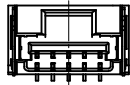

5 CKT.

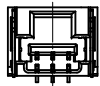

3 CKT.

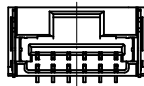

6 CKT.

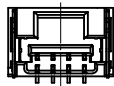

4 CKT.

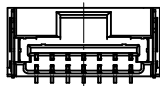

7 CKT.

極数の種類  
KIND OF CKT. NO. (FRONT VIEW)

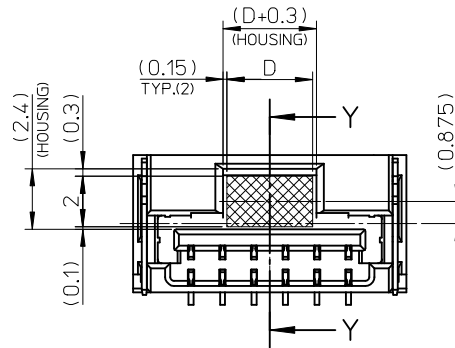

吸着範囲  
VACUME AREA

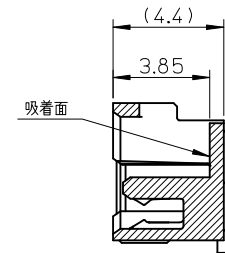

SECTION Y-Y

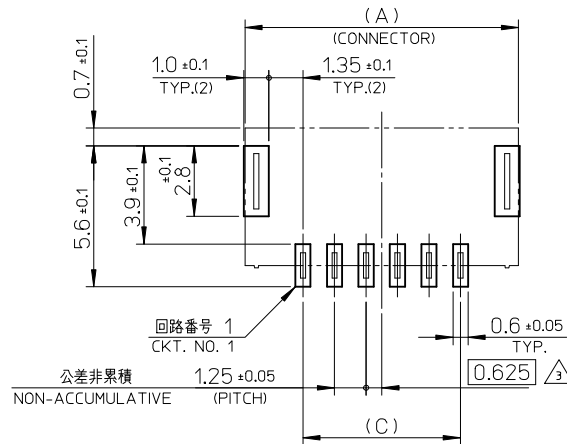

基板パターンレイアウト (参考)  
RECCOMENDED P.C.B. PATTERN LAYOUT (REF.)

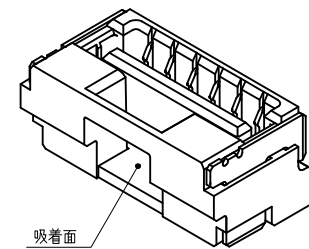

REVISED EC NO.: J2013-1131 DRWN:SSATO02 2013/04/08 CHKD:KASAKAWA 2013/04/08 APPR:Y01TO 2013/04/08	GENERAL TOLERANCES (UNLESS SPECIFIED)		DIMENSION STYLE MM ONLY	SCALE 5:1	DESIGN UNITS METRIC	THIRD ANGLE PROJECTION
	10 UNDER	±0.2	DRAWN BY T.MIYAZAKI	DATE 2006/08/28	TITLE 1.25 W/B CONN. SINGLE S/T REC. ASS'Y 2-7CKT.	
	10 OVER 30 UNDER	±0.25	CHECKED BY K.ASAKAWA	DATE 2006/08/28	<b>molex</b> DOCUMENT NO. SD-502382-001 SHEET NO. 2 OF 3	
	30 OVER	±0.3	APPROVED BY Y01.ITO	DATE 2006/08/28		
ANGULAR ±3 °	DRAFT WHERE APPLICABLE MUST REMAIN WITHIN DIMENSIONS		MATERIAL NO. SEE TABLE	THIS DRAWING CONTAINS INFORMATION THAT IS PROPRIETARY TO MOLEX INCORPORATED AND SHOULD NOT BE USED WITHOUT WRITTEN PERMISSION		

WITH CAPTON TAPE										
HSG COLOR : GREEN		HSG COLOR : BLUE		HSG COLOR : RED		HSG COLOR : BLACK		HSG COLOR : NATURAL		
502382-0736	502382-**16	502382-0734	502382-**14	502382-0732	502382-**12	502382-0731	502382-**11	502382-0772	502382-**08	7
502382-0636		502382-0634		502382-0632		502382-0631		502382-0672		6
502382-0536		502382-0534		502382-0532		502382-0531		502382-0572		5
502382-0436		502382-0434		502382-0432		502382-0431		502382-0472		4
502382-0336		502382-0334		502382-0332		502382-0331		502382-0372		3
502382-0236		502382-0234		502382-0232		502382-0231		502382-0272		2
EMBOSSSED TAPE PACKAGE オーダー番号ORDER No.	コネクタシリーズ CONNECTOR SERIES	EMBOSSSED TAPE PACKAGE オーダー番号ORDER No.	コネクタシリーズ CONNECTOR SERIES	EMBOSSSED TAPE PACKAGE オーダー番号ORDER No.	コネクタシリーズ CONNECTOR SERIES	EMBOSSSED TAPE PACKAGE オーダー番号ORDER No.	コネクタシリーズ CONNECTOR SERIES	EMBOSSSED TAPE PACKAGE オーダー番号ORDER No.	コネクタシリーズ CONNECTOR SERIES	極数 (KLT. NO.)

WITHOUT CAPTON TAPE		
HSG COLOR : NATURAL		
502382-0770	502382-**09	7
502382-0670		6
502382-0570		5
502382-0470		4
502382-0370		3
502382-0270		2
EMBOSSSED TAPE PACKAGE オーダー番号ORDER No.	コネクタシリーズ CONNECTOR SERIES	極数 (KLT. NO.)

REVISED EC NO: J2013-1131 DRW:SSAT002 2013/04/08 CHK:D.KASAKAWA 2013/04/08 APPR:Y0.ITO 2013/04/08	DESCRIPTION 10 UNDER ±0.2 10 OVER 30 UNDER ±0.25 30 OVER ±0.3 ANGULAR ±3 ° DRAFT WHERE APPLICABLE MUST REMAIN WITHIN DIMENSIONS	GENERAL TOLERANCES (UNLESS SPECIFIED)	DIMENSION STYLE MM ONLY	SCALE ----- METRIC	DESIGN UNITS ◎ □ THIRD ANGLE PROJECTION
		DRAWN BY DATE T.MIYAZAKI 2006/08/28	TITLE 1.25 W/B CONN. SINGLE S/T REC. ASS'Y 2-7CKT.		
		CHECKED BY DATE K.ASAKAWA 2006/08/28	APPROVED BY DATE Y0.ITO 2006/08/28		
		MATERIAL NO. SEE TABLE	DOCUMENT NO. SD-502382-001		
		SIZE A3	SHEET NO. 3 OF 3		

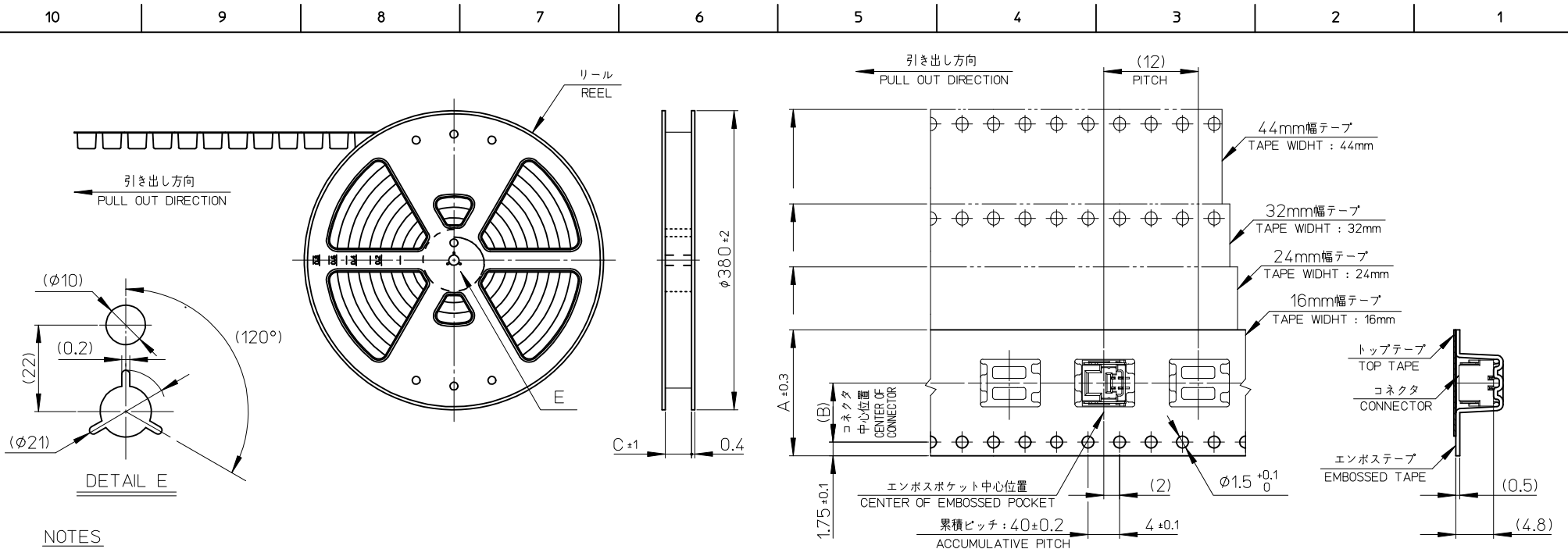

**NOTES**

- 製品詳細寸法については、SD-502382-001, -002 を参照下さい。  
PLEASE REFER TO SD-502382-001, -002 FOR THE DETAILED DIMENSION OF THE CONNECTOR.
- 梱包数量 : 1400個  
NUMBER OF CONNECTORS : 1400 PIECES/REEL.
- リードテープ長さ  
LEAD TAPE LENGTH

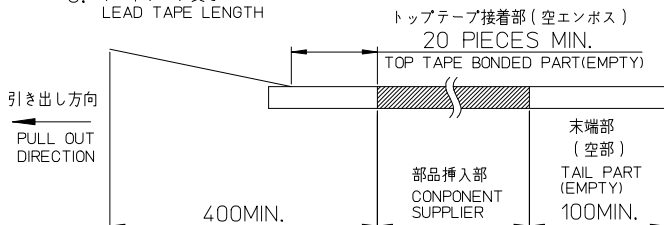

- 材料  
MATERIAL  
キャリアテープ : ポリスチレン  
CARRIER TAPE : POLYSTYRENE  
トップテープ : ポリエステル、ポリエチレン、ポリエチレンテレフタレート  
TOP TAPE : POLYESTER, POLYETHYLENE, POLYETHYLENE TEREPHTHALATE  
リール : ポリスチレン <リサイクル材を含む>  
REEL : POLYSTYRENE <RECYCLE MATERIAL CONTAINED>
- ELV 及び RoHS 適合品  
ELV AND RoHS COMPLIANT

45.5	20.2	44	502382-15**	15
45.5	20.2	44	502382-14**	14
33.5	14.2	32	502382-13**	13
33.5	14.2	32	502382-12**	12
33.5	14.2	32	502382-11**	11
33.5	14.2	32	502382-10**	10
25.5	11.5	24	502382-09**	9
25.5	11.5	24	502382-08**	8
25.5	11.5	24	502382-07**	7
25.5	11.5	24	502382-06**	6
25.5	11.5	24	502382-05**	5
25.5	11.5	24	502382-04**	4
17.5	7.5	16	502382-03**	3
17.5	7.5	16	502382-02**	2

C	B	エンボステープ幅 A WIDTH OF TAPE	製品番号 MATERIAL NO.	極数 (CT. NO.)
---	---	-----------------------------	----------------------	-----------------

<b>REVISED</b> EC NO: J2013-0870 DRWN: KWASHIO 2013/02/07 CHKD: KASAKAWA 2013/02/13 APPR: YO ITO 2013/02/13 REV:	GENERAL TOLERANCES (UNLESS SPECIFIED)		DIMENSION STYLE MM ONLY		SCALE ---	DESIGN UNITS METRIC		THIRD ANGLE PROJECTION	
	10 UNDER	±0.2	DRAWN BY T. MIYAZAKI	DATE 2006/10/16	TITLE 1.25 W/B CONN. SINGLE S/T REC. EMBTP PKG				
	10 OVER 30 UNDER	±0.25	CHECKED BY K. ASAKAWA	DATE 2006/10/16					
	30 OVER	±0.3	APPROVED BY YO. ITO	DATE 2006/10/16					
ANGULAR ±3 °		MATERIAL NO.		DOCUMENT NO.		SHEET NO.			
DRAFT WHERE APPLICABLE MUST REMAIN WITHIN DIMENSIONS		SEE TABLE		SD-502382-003		1 OF 2			
		SIZE A3		THIS DRAWING CONTAINS INFORMATION THAT IS PROPRIETARY TO MOLEX INCORPORATED AND SHOULD NOT BE USED WITHOUT WRITTEN PERMISSION					

## Looking for pricing, stock, or lifecycle information?

Click below to explore more details on WIN SOURCE:

 [View 5023820670 on WIN SOURCE](#)

 [Molex, LLC Information](#)

## Optimize Your Supply Chain with WIN SOURCE Solutions

-  Global Sourcing Solution
-  Obsolete Management
-  Cost Control Management
-  Shortage Management
-  Alternative Solution
-  Excess Inventory Management