



**THE DATASHEET OF
PT6429P**



- Adjustable Output Voltage
- 85% Efficiency
- Small SIP Footprint
- Input Voltage Range: 4.5V to 5.5V
- Remote Sense Capability

The PT6420 series from Power Trends is a high performance +5V to +3.3V, 3Amp family of 14-Pin SIP (Single In-line Package) Integrated Switching Regulators (ISRs). Only two external capacitors are required for proper operation.

Please note that this product does not include short circuit protection.

Standard Application

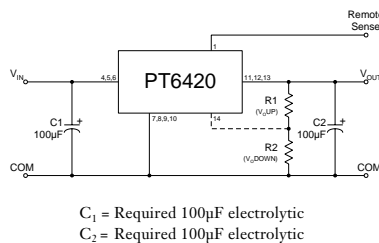

Pin-Out Information

Pin	Function
1	Remote Sense
2	Do not connect
3	Do not connect
4	V_{in}
5	V_{in}
6	V_{in}
7	GND
8	GND
9	GND
10	GND
11	V_{out}
12	V_{out}
13	V_{out}
14	V_{out} Adjust

Ordering Information

PT6424	= +1.5 Volts
PT6425	= +3.3 Volts
PT6426	= +1.8 Volts
PT6427	= +2.1 Volts
PT6428	= +1.2 Volts
PT6429	= +2.5 Volts

PT Series Suffix (PT1234X)

Case/Pin Configuration	Suffix
Vertical Through-Hole	P
Horizontal Through-Hole	D
Horizontal Surface Mount	E

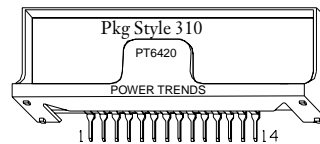

Note: Back surface of product is conducting metal.

Specifications

Characteristics ($T_a = 25^\circ\text{C}$ unless noted)	Symbols	Conditions	PT6420 SERIES			Units
			Min	Typ	Max	
Output Current	I_o	$4.5\text{V} \leq V_{in} \leq 5.5\text{V}$	0	—	3.0	A
Current Limit	I_{cl}	$V_{in} = +5\text{V}$	—	3.6	5.0	A
Input Voltage Range	V_{in}	$0.1\text{A} \leq I_o \leq 3.0\text{A}$	4.5	—	5.5	V
Output Voltage Tolerance	ΔV_o	$V_{in} = +5\text{V}$, $I_o = 3.0\text{A}$ $0^\circ\text{C} \leq T_a \leq +70^\circ\text{C}$	$V_o - 0.05$	3.3	$V_o + 0.05$	V
Line Regulation	Reg_{line}	$4.5\text{V} \leq V_{in} \leq 5.5\text{V}$, $I_o = 3.0\text{A}$	—	± 10	± 25	mV
Load Regulation	Reg_{load}	$V_{in} = +5\text{V}$, $0.3 \leq I_o \leq 3.0\text{A}$	—	$\pm 10^*$	$\pm 25^*$	mV
V_o Ripple/Noise	V_n	$V_{in} = 5\text{V}$, $I_o = 3.0\text{A}$	—	66	165	mVpp
Transient Response with $C_2 = 100\mu\text{F}$	t_{tr} V_{os}	I_o step between 1.5A and 3.0A V_o over/undershoot	—	200 200	—	μSec mV
Efficiency	η	$V_{in} = +5\text{V}$, $I_o = 1.5\text{A}$ $V_o = 3.3\text{V}$ $V_o = 1.8\text{V}$ $V_o = 2.1\text{V}$ $V_o = 1.2\text{V}$	—	85 74 77 63	—	% % % %
Switching Frequency	f_o	$4.5\text{V} \leq V_{in} \leq 5.5\text{V}$ $0.3\text{A} \leq I_o \leq 3.0\text{A}$	500	650	800	kHz
Absolute Maximum Operating Temperature Range	T_a		0	—	+85	$^\circ\text{C}$
Recommended Operating Temperature Range	T_a	Free Air Convection (40-60 LFM) At $V_{in} = 5\text{V}$, $I_o = 2.5\text{A}$	0	—	+70**	$^\circ\text{C}$
Thermal Resistance	θ_{ja}	Free Air Convection (40-60 LFM)	—	25	—	$^\circ\text{C}/\text{W}$
Storage Temperature	T_s	—	-40	—	+125	$^\circ\text{C}$
Mechanical Shock		Per Mil-STD-883D, Method 2002.3, 1 msec, Half Sine, mounted to a fixture	—	500	—	G's
Mechanical Vibration		Per Mil-STD-883D, Method 2007.2, 20-2000 Hz, Soldered in a PC board	—	15	—	G's
Weight	—	—	—	6.5	—	grams

*When used with remote sense function.

**See Thermal Derating chart.

Note: The PT6420 Series requires two 100µF electrolytic or tantalum capacitors for proper operation in all applications.

3 Amp 5V Input Adjustable Integrated Switching Regulator

PT6428 1.2 VDC (See Note 1)

Efficiency vs Output Current

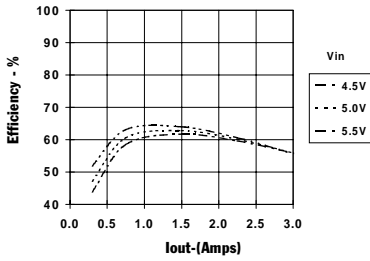

Ripple vs Output Current

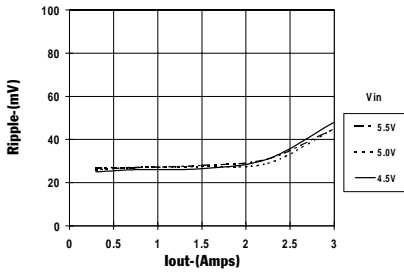

Thermal Derating (T_a) (See Note 2)

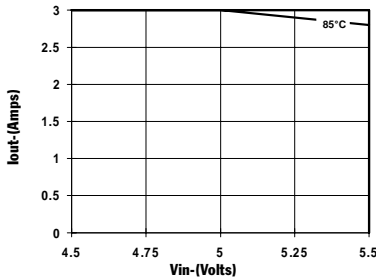

Power Dissipation vs Output Current

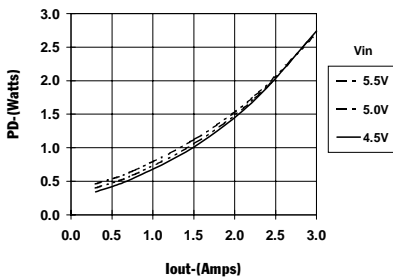

PT6427, 2.1 VDC (See Note 1)

Efficiency vs Output Current

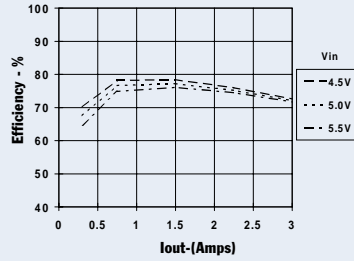

Ripple vs Output Current

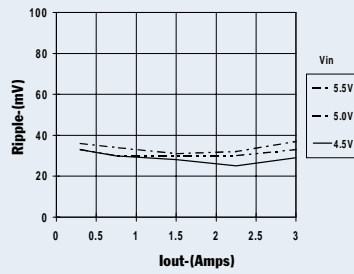

Thermal Derating (T_a) (See Note 2)

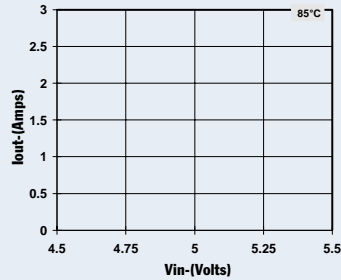

Power Dissipation vs Output Current

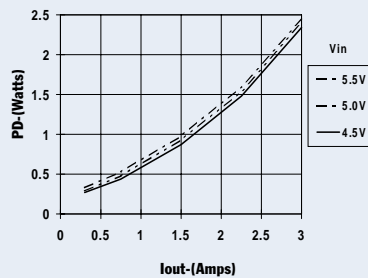

PT6425, 3.3 VDC (See Note 1)

Efficiency vs Output Current

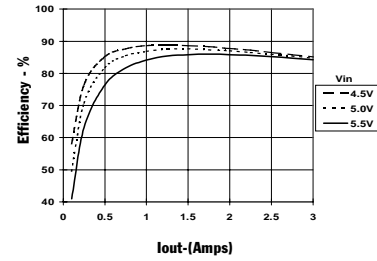

Ripple vs Output Current

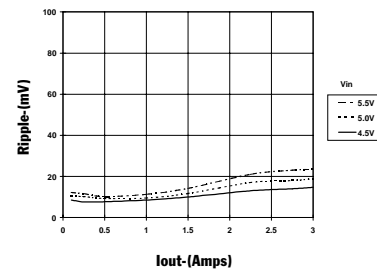

Thermal Derating (T_a) (See Note 2)

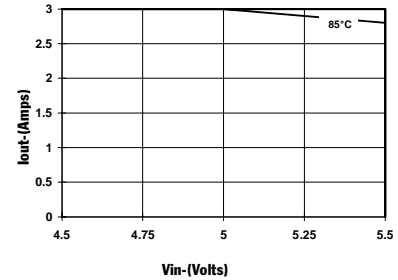

Power Dissipation vs Output Current

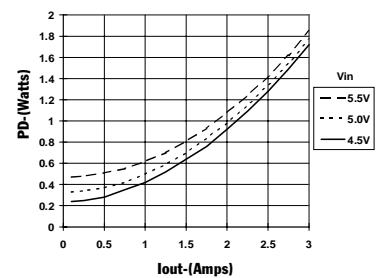

Note 1: All data listed in the above graphs except for derating data has been developed from actual products tested at 25°C. This data is considered typical data for the ISR.
Note 2: Thermal derating graphs are developed in free air convection cooling of 40-60 LFM. (See Thermal Application Notes.)

PT6420 Series

Adjusting the Output Voltage of the PT6420 Series 3AMP 5V Bus Converters

The output voltage of the Power Trends PT6420 Series ISRs may be adjusted higher or lower than the factory trimmed pre-set voltage with the addition of a single external resistor. Table 1 accordingly gives the allowable adjustment range for each model in the series as V_a (min) and V_a (max).

Adjust Up: (See note 1) An increase in the output voltage is obtained by adding a resistor R1, between pin 14 (V_o adjust) and pins 11-13 (V_{out}).

Adjust Down: (See note 1) Add a resistor (R2), between pin 14 (V_o adjust) and pins 7-10 (GND).

Refer to Figure 1 and Table 2 for both the placement and value of the required resistor; either R1 or (R2) as appropriate.

Notes:

- The direction in which each resistor adjusts the output of the PT6420 series differs from many other Power Trends products. These output voltage adjustment notes are therefore specific only to the PT6420 models.
- Use only a single 1% resistor in either the R1 or (R2) location. Place the resistor as close to the ISR as possible.
- Never connect capacitors from V_o adjust to either GND, V_{out} , or the Remote Sense pin. Any capacitance added to the V_o adjust pin will affect the stability of the ISR.
- The PT6420 incorporates a Remote Sense (See Figure 1). If this feature is being used, connecting the resistor R1 between pin 14 (V_o adjust) and pin 1 (Remote Sense) can benefit load regulation.
- An increase in the output voltage may place additional limits on the input voltage range of the part. The revised minimum input voltage will be ($V_{out} + 1.2$) or 4.5V, whichever is higher. Do not exceed 5.5Vdc.

Figure 1

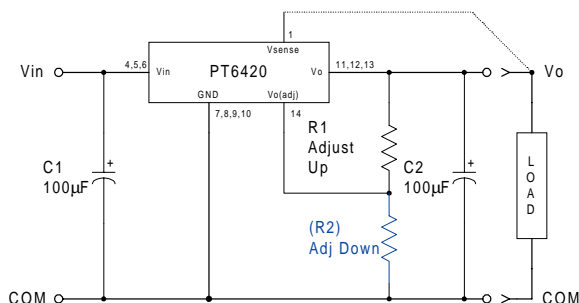

The values of R1 [adjust up], and (R2) [adjust down], can also be calculated using the following formulae.

$$R1 = \frac{12.45 V_o}{(V_a - V_o)} - 49.9 \quad \text{k}\Omega$$

$$(R2) = \frac{12.45 (2V_a - V_o)}{V_o - V_a} - 49.9 \quad \text{k}\Omega$$

Where: V_o = Original output voltage
 V_a = Adjusted output voltage

Table 1

PT6420 ADJUSTMENT RANGE						
Series Pt #	PT6428	PT6424	PT6426	PT6427	PT6429	PT6425
V_o (nom)	1.2	1.5	1.8	2.1	2.5	3.3
V_a (min)	1.1	1.3	1.5	1.8	2.1	2.8
V_a (max)	1.4	1.8	2.2	2.6	3.1	3.8

PT6420 Series

Table 2

PT6420 ADJUSTMENT RESISTOR VALUES

Series Pt #	PT6428	PT6424	PT6426	PT6427	PT6429	PT6425
V_o (nom)	1.2	1.5	1.8	2.1	2.5	3.3
V_a (req'd)						
1.1	(74.6)k Ω					
1.15	(224.0)k Ω					
1.2						
1.25	249.0k Ω					
1.3	99.5k Ω	(18.6)k Ω				
1.35	49.7k Ω	(49.7)k Ω				
1.4	24.8k Ω	(112.0)k Ω				
1.45		(299.0)k Ω				
1.5			(0.0)k Ω			
1.55		324.0k Ω	(14.8)k Ω			
1.6		137.0k Ω	(37.3)k Ω			
1.65		74.6k Ω	(74.6)k Ω			
1.7		43.5k Ω	(149.0)k Ω			
1.75		24.8k Ω	(373.0)k Ω			
1.8		12.4k Ω		(12.4)k Ω		
1.85			398.0k Ω	(29.8)k Ω		
1.9			174.0k Ω	(55.9)k Ω		
1.95			99.5k Ω	(99.5)k Ω		
2.0			62.2k Ω	(187.0)k Ω		
2.05			39.7k Ω	(448.0)k Ω		
2.1			24.8k Ω		(3.0)k Ω	
2.15			14.1k Ω	473.0k Ω	(14.1)k Ω	
2.2			6.1k Ω	212.0k Ω	(29.0)k Ω	
2.25				124.0k Ω	(49.7)k Ω	
2.3				80.8k Ω	(80.8)k Ω	
2.35				54.7k Ω	(133.0)k Ω	
2.4				37.3k Ω	(236.0)k Ω	
2.45				24.8k Ω	(548.0)k Ω	
2.5				15.5k Ω		
2.55				8.2k Ω	573.0k Ω	
2.6				2.4k Ω	261.0k Ω	
2.65					158.0k Ω	
2.7					106.0k Ω	
2.75					74.6k Ω	
2.8					53.9k Ω	(7.4)k Ω
2.85					39.0k Ω	(16.5)k Ω
2.9					27.9k Ω	(27.9)k Ω
2.95					19.3k Ω	(42.6)k Ω
3.0					12.4k Ω	(62.2)k Ω
3.1					2.0k Ω	(131.0)k Ω
3.2						(336.0)k Ω
3.3						
3.4						361.0k Ω
3.5						156.0k Ω
3.6						87.0k Ω
3.7						52.8k Ω
3.8						32.3k Ω

R1 = Black R2 = (Blue)

IMPORTANT NOTICE

Texas Instruments and its subsidiaries (TI) reserve the right to make changes to their products or to discontinue any product or service without notice, and advise customers to obtain the latest version of relevant information to verify, before placing orders, that information being relied on is current and complete. All products are sold subject to the terms and conditions of sale supplied at the time of order acknowledgment, including those pertaining to warranty, patent infringement, and limitation of liability.

TI warrants performance of its semiconductor products to the specifications applicable at the time of sale in accordance with TI's standard warranty. Testing and other quality control techniques are utilized to the extent TI deems necessary to support this warranty. Specific testing of all parameters of each device is not necessarily performed, except those mandated by government requirements.

Customers are responsible for their applications using TI components.

In order to minimize risks associated with the customer's applications, adequate design and operating safeguards must be provided by the customer to minimize inherent or procedural hazards.

TI assumes no liability for applications assistance or customer product design. TI does not warrant or represent that any license, either express or implied, is granted under any patent right, copyright, mask work right, or other intellectual property right of TI covering or relating to any combination, machine, or process in which such semiconductor products or services might be or are used. TI's publication of information regarding any third party's products or services does not constitute TI's approval, warranty or endorsement thereof.

IMPORTANT NOTICE

Texas Instruments and its subsidiaries (TI) reserve the right to make changes to their products or to discontinue any product or service without notice, and advise customers to obtain the latest version of relevant information to verify, before placing orders, that information being relied on is current and complete. All products are sold subject to the terms and conditions of sale supplied at the time of order acknowledgment, including those pertaining to warranty, patent infringement, and limitation of liability.

TI warrants performance of its semiconductor products to the specifications applicable at the time of sale in accordance with TI's standard warranty. Testing and other quality control techniques are utilized to the extent TI deems necessary to support this warranty. Specific testing of all parameters of each device is not necessarily performed, except those mandated by government requirements.

Customers are responsible for their applications using TI components.

In order to minimize risks associated with the customer's applications, adequate design and operating safeguards must be provided by the customer to minimize inherent or procedural hazards.

TI assumes no liability for applications assistance or customer product design. TI does not warrant or represent that any license, either express or implied, is granted under any patent right, copyright, mask work right, or other intellectual property right of TI covering or relating to any combination, machine, or process in which such semiconductor products or services might be or are used. TI's publication of information regarding any third party's products or services does not constitute TI's approval, warranty or endorsement thereof.

Looking for pricing, stock, or lifecycle information?

Click below to explore more details on WIN SOURCE:

 [View PT6429P](#) on WIN SOURCE

 [Texas Instruments](#) Information

Optimize Your Supply Chain with WIN SOURCE Solutions

-  Global Sourcing Solution
-  Obsolete Management
-  Cost Control Management
-  Shortage Management
-  Alternative Solution
-  Excess Inventory Management