



THE DATASHEET OF
4N35-X006





| ABSOLUTE MAXIMUM RATINGS (T _{amb} = 25 °C, unless otherwise specified) | | | | |
|---|--|-------------------|--------------------|------------------|
| PARAMETER | TEST CONDITION | SYMBOL | VALUE | UNIT |
| INPUT | | | | |
| Reverse voltage | | V _R | 6 | V |
| Forward current | | I _F | 60 | mA |
| Surge current | t ≤ 10 μs | I _{FSM} | 2.5 | A |
| Power dissipation | | P _{diss} | 70 | mW |
| OUTPUT | | | | |
| Collector emitter breakdown voltage | | V _{CEO} | 70 | V |
| Emitter base breakdown voltage | | V _{EBO} | 7 | V |
| Collector current | | I _C | 50 | mA |
| Collector peak current | t _p /T = 0.5, t _p ≤ 10 ms | I _{CM} | 100 | mA |
| Output power dissipation | | P _{diss} | 150 | mW |
| COUPLER | | | | |
| Isolation test voltage | t = 1 s | V _{ISO} | 5000 | V _{RMS} |
| Creepage distance | | | ≥ 7 | mm |
| Clearance distance | | | ≥ 7 | mm |
| Isolation thickness between emitter and detector | | | ≥ 0.4 | mm |
| Comparative tracking index | DIN IEC 112/VDE 0303, part 1 | | ≥ 175 | |
| Isolation resistance | V _{IO} = 500 V, T _{amb} = 25 °C | R _{IO} | ≥ 10 ¹² | Ω |
| | V _{IO} = 500 V, T _{amb} = 100 °C | R _{IO} | ≥ 10 ¹¹ | Ω |
| Storage temperature | | T _{stg} | - 55 to + 150 | °C |
| Operating temperature | | T _{amb} | - 55 to + 100 | °C |
| Soldering temperature ⁽¹⁾ | 2 mm from case, ≤ 10 s | T _{sld} | 260 | °C |

Notes

- Stresses in excess of the absolute maximum ratings can cause permanent damage to the device. Functional operation of the device is not implied at these or any other conditions in excess of those given in the operational sections of this document. Exposure to absolute maximum ratings for extended periods of the time can adversely affect reliability.
- ⁽¹⁾ Refer to reflow profile for soldering conditions for surface mounted devices (SMD). Refer to wave profile for soldering conditions for through hole devices (DIP).

| ELECTRICAL CHARACTERISTICS (T _{amb} = 25 °C, unless otherwise specified) | | | | | | | |
|---|--|------|-------------------|------|------|------|------|
| PARAMETER | TEST CONDITION | PART | SYMBOL | MIN. | TYP. | MAX. | UNIT |
| INPUT | | | | | | | |
| Forward voltage ⁽¹⁾ | I _F = 10 mA | | V _F | | 1.2 | 1.5 | V |
| | I _F = 10 mA, T _{amb} = - 55 °C | | V _F | 0.9 | 1.3 | 1.7 | V |
| Reverse current ⁽¹⁾ | V _R = 6 V | | I _R | | 0.1 | 10 | μA |
| Capacitance | V _R = 0 V, f = 1 MHz | | C _O | | 25 | | pF |
| OUTPUT | | | | | | | |
| Collector emitter breakdown voltage ⁽¹⁾ | I _C = 1 mA | 4N35 | BV _{CEO} | 30 | | | V |
| | | 4N36 | BV _{CEO} | 30 | | | V |
| | | 4N37 | BV _{CEO} | 30 | | | V |
| | | 4N38 | BV _{CEO} | 80 | | | V |
| Emitter collector breakdown voltage ⁽¹⁾ | I _E = 100 μA | | BV _{ECO} | 7 | | | V |
| Collector base breakdown voltage ⁽¹⁾ | I _C = 100 μA, I _B = 1 μA | 4N35 | BV _{CBO} | 70 | | | V |
| | | 4N36 | BV _{CBO} | 70 | | | V |
| | | 4N37 | BV _{CBO} | 70 | | | V |
| | | 4N38 | BV _{CBO} | 80 | | | V |

| ELECTRICAL CHARACTERISTICS ($T_{amb} = 25\text{ }^{\circ}\text{C}$, unless otherwise specified) | | | | | | | | |
|--|---|------|-----------|-----------|------|------|---------------|---------------|
| PARAMETER | TEST CONDITION | PART | SYMBOL | MIN. | TYP. | MAX. | UNIT | |
| OUTPUT | | | | | | | | |
| Collector emitter leakage current ⁽¹⁾ | $V_{CE} = 10\text{ V}, I_F = 0$ | 4N35 | I_{CEO} | | 5 | 50 | nA | |
| | | 4N36 | I_{CEO} | | 5 | 50 | nA | |
| | $V_{CE} = 10\text{ V}, I_F = 0$ | 4N37 | I_{CEO} | | 5 | 50 | nA | |
| | $V_{CE} = 60\text{ V}, I_F = 0$ | 4N38 | I_{CEO} | | | 50 | nA | |
| | $V_{CE} = 30\text{ V}, I_F = 0,$ $T_{amb} = 100\text{ }^{\circ}\text{C}$ | | 4N35 | I_{CEO} | | | 500 | μA |
| | | | 4N36 | I_{CEO} | | | 500 | μA |
| | | 4N37 | I_{CEO} | | | 500 | μA | |
| | $V_{CE} = 60\text{ V}, I_F = 0,$ $T_{amb} = 100\text{ }^{\circ}\text{C}$ | 4N38 | I_{CEO} | | 6 | | μA | |
| Collector emitter capacitance | $V_{CE} = 0$ | | C_{CE} | | 6 | | pF | |
| coupler | | | | | | | | |
| Resistance, input output ⁽¹⁾ | $V_{IO} = 500\text{ V}$ | | R_{IO} | 10^{11} | | | Ω | |
| Capacitance, input output | $f = 1\text{ MHz}$ | | C_{IO} | | 0.5 | | pF | |

Notes

- Minimum and maximum values are testing requirements. Typical values are characteristics of the device and are the result of engineering evaluation. Typical values are for information only and are not part of the testing requirements.
- ⁽¹⁾ Indicates JEDEC registered value.

| CURRENT TRANSFER RATIO ($T_{amb} = 25\text{ }^{\circ}\text{C}$, unless otherwise specified) | | | | | | | | |
|--|---|------|------------|------------|------|------|------|---|
| PARAMETER | TEST CONDITION | PART | SYMBOL | MIN. | TYP. | MAX. | UNIT | |
| I_C/I_F ⁽¹⁾ | $V_{CE} = 10\text{ V}, I_F = 10\text{ mA}$ | 4N35 | CTR_{DC} | 100 | | | % | |
| | | 4N36 | CTR_{DC} | 100 | | | % | |
| | | 4N37 | CTR_{DC} | 100 | | | % | |
| | $V_{CE} = 10\text{ V}, I_F = 20\text{ mA}$ | 4N38 | CTR_{DC} | 20 | | | % | |
| | $V_{CE} = 10\text{ V}, I_F = 10\text{ mA},$ $T_A = -55\text{ }^{\circ}\text{C to } +100\text{ }^{\circ}\text{C}$ | | 4N35 | CTR_{DC} | 40 | 50 | | % |
| | | | 4N36 | CTR_{DC} | 40 | 50 | | % |
| | | 4N37 | CTR_{DC} | 40 | 50 | | % | |
| | | 4N38 | CTR_{DC} | | 30 | | % | |

Note

- ⁽¹⁾ Indicates JEDEC registered values.

| SWITCHING CHARACTERISTICS ($T_{amb} = 25\text{ }^{\circ}\text{C}$, unless otherwise specified) | | | | | | | |
|---|---|-----------|------|------|------|---------------|--|
| PARAMETER | TEST CONDITION | SYMBOL | MIN. | TYP. | MAX. | UNIT | |
| Turn-on time ⁽¹⁾ | $V_{CC} = 5\text{ V}, I_C = 2\text{ mA}, R_L = 100\text{ }\Omega$ | t_{on} | | 10 | | μs | |
| Turn-off time ⁽¹⁾ | $V_{CC} = 5\text{ V}, I_C = 2\text{ mA}, R_L = 100\text{ }\Omega$ | t_{off} | | 10 | | μs | |

Note

- ⁽¹⁾ Indicates JEDEC registered values.

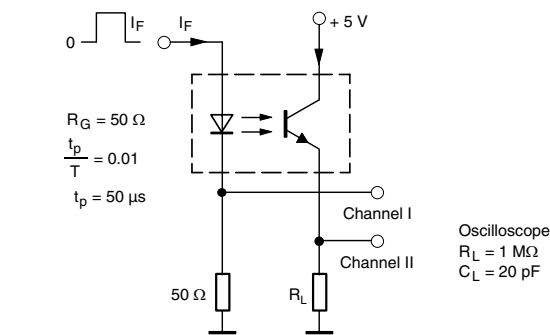

Fig. 1 - Test Circuit, Non-Saturated Operation

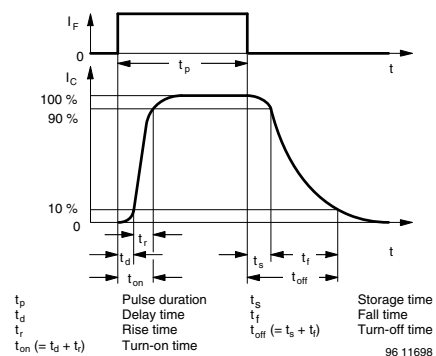

Fig. 2 - Switching Times

TYPICAL CHARACTERISTICS ($T_{amb} = 25\text{ }^{\circ}\text{C}$, unless otherwise specified)

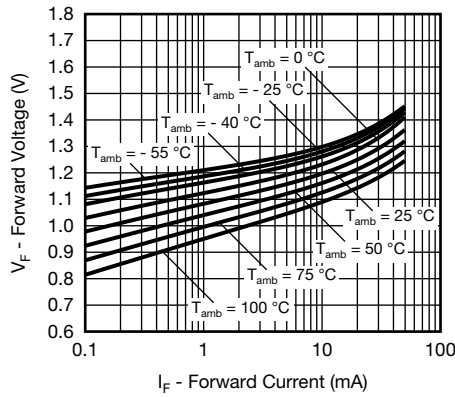

Fig. 3 - Forward Voltage vs. Forward Current

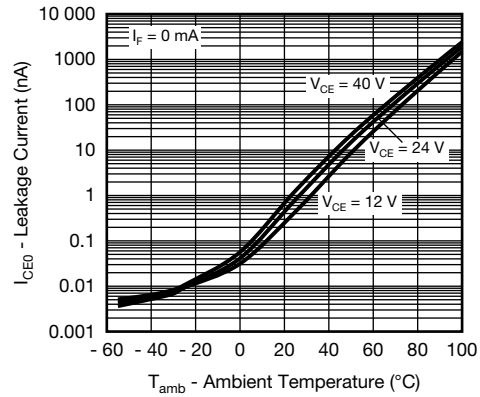

Fig. 6 - Leakage Current vs. Ambient Temperature

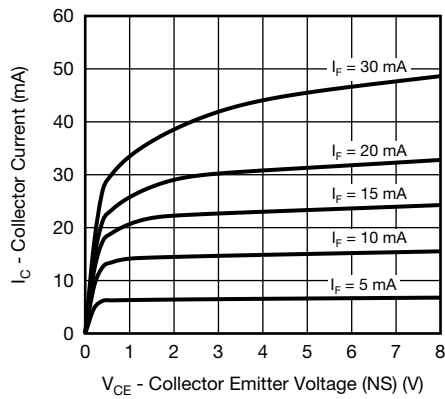

Fig. 4 - Collector Current vs. Collector Emitter Voltage (NS)

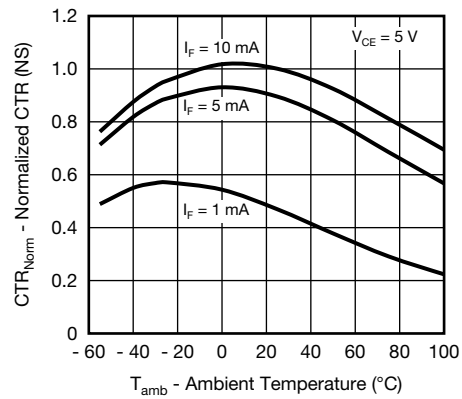

Fig. 7 - Normalized CTR (NS) vs. Ambient Temperature

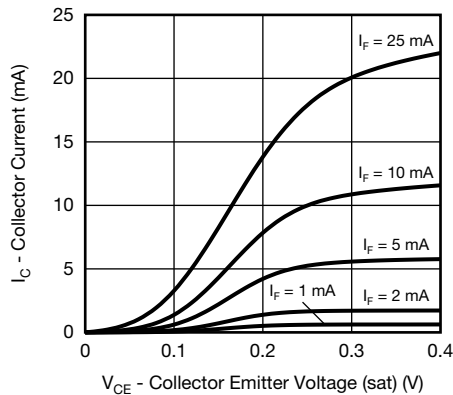

Fig. 5 - Collector Current vs. Collector Emitter Voltage (sat)

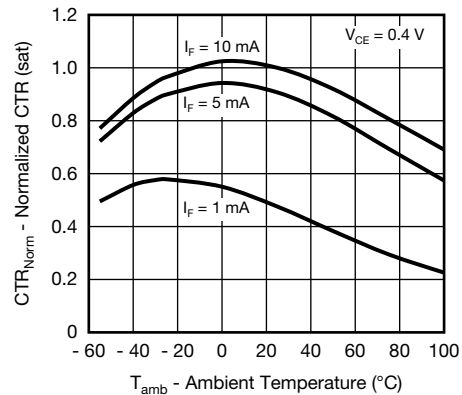

Fig. 8 - Normalized CTR (sat) vs. Ambient Temperature

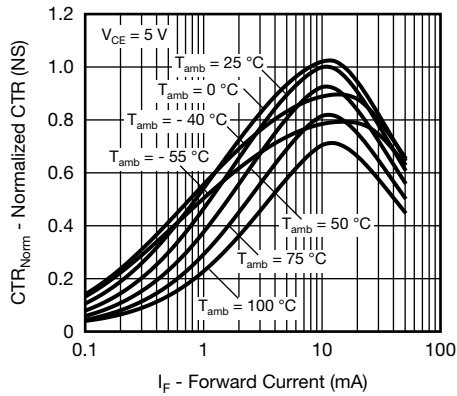

Fig. 9 - Normalized CTR (NS) vs. Forward Current

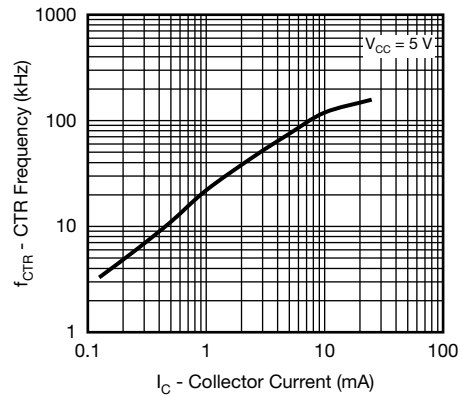

Fig. 12 - CTR Frequency vs. Collector Current

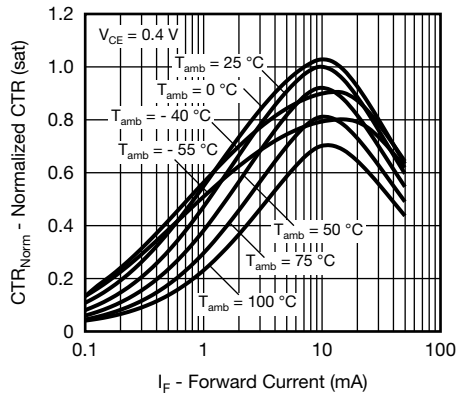

Fig. 10 - Normalized CTR (sat) vs. Forward Current

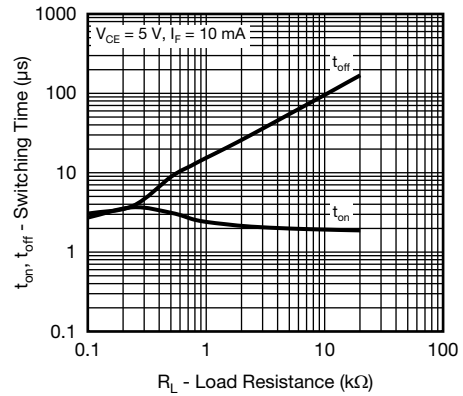

Fig. 13 - Switching Time vs. Load Resistance

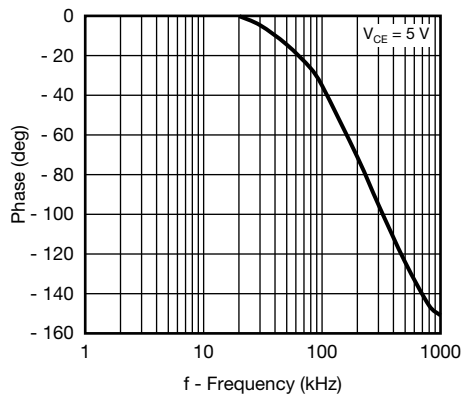
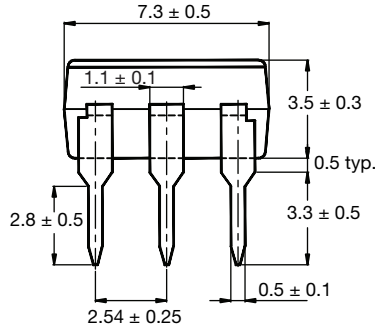
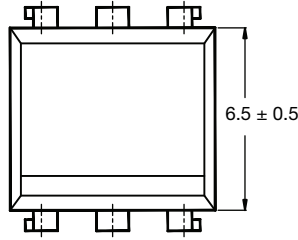

Fig. 11 - CTR Frequency vs. Phase Angle



PACKAGE DIMENSIONS in millimeters



22530

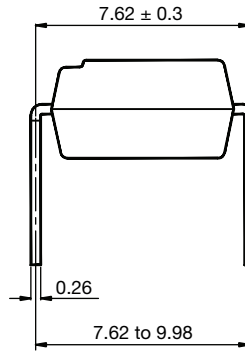

Option 6

Option 7

Option 9

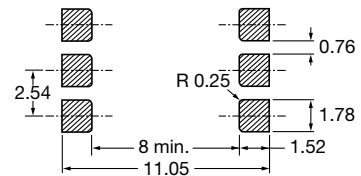
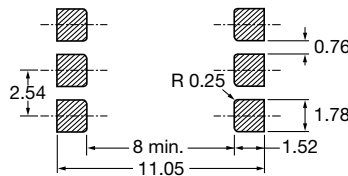
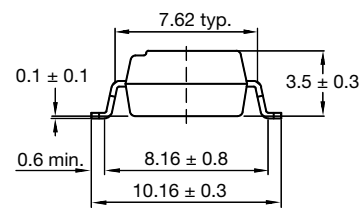
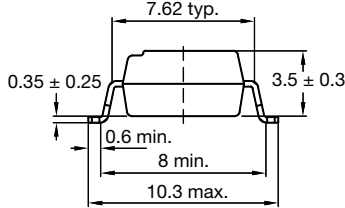
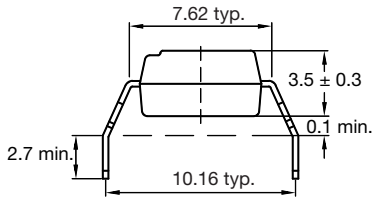

20802-34

PACKAGE MARKING

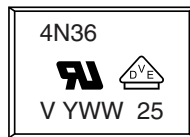

Notes

- VDE logo is only marked on option 1 parts. Option information is not marked on the part.
- Tape and reel suffix (T) is not part of the package marking.



Disclaimer

ALL PRODUCT, PRODUCT SPECIFICATIONS AND DATA ARE SUBJECT TO CHANGE WITHOUT NOTICE TO IMPROVE RELIABILITY, FUNCTION OR DESIGN OR OTHERWISE.

Vishay Intertechnology, Inc., its affiliates, agents, and employees, and all persons acting on its or their behalf (collectively, "Vishay"), disclaim any and all liability for any errors, inaccuracies or incompleteness contained in any datasheet or in any other disclosure relating to any product.

Vishay makes no warranty, representation or guarantee regarding the suitability of the products for any particular purpose or the continuing production of any product. To the maximum extent permitted by applicable law, Vishay disclaims (i) any and all liability arising out of the application or use of any product, (ii) any and all liability, including without limitation special, consequential or incidental damages, and (iii) any and all implied warranties, including warranties of fitness for particular purpose, non-infringement and merchantability.

Statements regarding the suitability of products for certain types of applications are based on Vishay's knowledge of typical requirements that are often placed on Vishay products in generic applications. Such statements are not binding statements about the suitability of products for a particular application. It is the customer's responsibility to validate that a particular product with the properties described in the product specification is suitable for use in a particular application. Parameters provided in datasheets and / or specifications may vary in different applications and performance may vary over time. All operating parameters, including typical parameters, must be validated for each customer application by the customer's technical experts. Product specifications do not expand or otherwise modify Vishay's terms and conditions of purchase, including but not limited to the warranty expressed therein.

Except as expressly indicated in writing, Vishay products are not designed for use in medical, life-saving, or life-sustaining applications or for any other application in which the failure of the Vishay product could result in personal injury or death. Customers using or selling Vishay products not expressly indicated for use in such applications do so at their own risk. Please contact authorized Vishay personnel to obtain written terms and conditions regarding products designed for such applications.

No license, express or implied, by estoppel or otherwise, to any intellectual property rights is granted by this document or by any conduct of Vishay. Product names and markings noted herein may be trademarks of their respective owners.

Looking for pricing, stock, or lifecycle information?

Click below to explore more details on WIN SOURCE:

 [View 4N35-X006 on WIN SOURCE](#)

 [Vishay Information](#)

Optimize Your Supply Chain with WIN SOURCE Solutions

-  Global Sourcing Solution
-  Obsolete Management
-  Cost Control Management
-  Shortage Management
-  Alternative Solution
-  Excess Inventory Management