

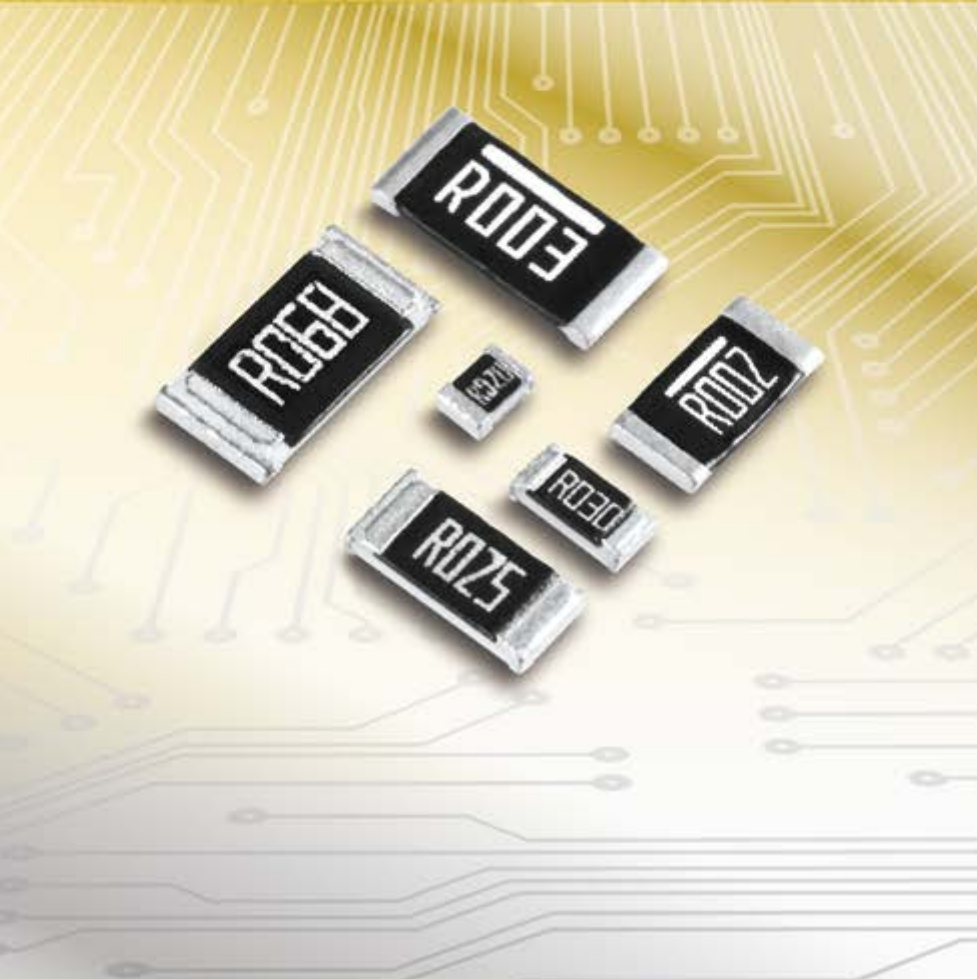

Current Sensing Chip Resistors



www.yageo.com

About Yageo



Founded in 1977, the Yageo Corporation has become a world-class provider of passive component services with capabilities on a global scale, including production and sales facilities in Asia, Europe and the Americas.

Yageo currently ranks as the world No.1 in chip-resistors, No. 3 in MLCCs and No. 4 in ferrite products, with a strong global presence: 21 sales offices in 15 countries, 9 production sites, 8 JIT logistic hubs, and 2 R&D centers worldwide. Ferroxcube and Vitrohm, who produce ferrites and leaded resistors, are also a part of the Yageo group.

We support our customers with extensive literature including datasheets, brochures and application notes, which are also available electronically on our website at: www.yageo.com

Table of Contents

Introduction.....	3
Current-Sensing Circuit Applications	4
Market Applications	6
Product Portfolio.....	7
Product Selection Tables	10



Introduction

Low Resistance, High Power for Current Sensing Applications

Current measurement is very important in power and instrumentation systems for circuit control, protection, monitoring, and performance enhancement. Engineers in power supply and battery circuit designs need to consider a give-and-take strategy between low resistance values to minimize power losses and sufficient voltage supplies to avoid noises generated from the environments or particularly in switch mode power supplies.

Yageo's current-sensing chip resistors are also fully compatible with today's high volume pick-and-place assembly systems. As such, they offer attractive, cost-effective solutions to designers of low voltage power supplies and battery management systems. Featuring a comprehensive resistance range of 0.5 milli-ohms to 1 ohm (low-ohmic), and available from 0.05 to 5 watts, they are not only applicable to battery packs, power supplies and converters, but also suitable for use in diverse power control circuits of tablets, notebook computers and hard disks.

Yageo now offers three types of surface-mount (SMT) current-sensing chip resistors based on thick film, metal foil, and metal plate technologies, with scalable product portfolios to meet the various demands of customers and their applications.

Main Features of Yageo's Current-Sensing Chip Resistors

- Low resistance value from 1 m Ω to 20 m Ω for minimizing power losses.
- High power-rating from 0.05 to 5 watts.
- Tight tolerance within 2% to exhibit actual current via voltage reading.
- Low TCR to avoid measurement distortions. TCR ranges from 50 to 100ppm/ $^{\circ}$ C for metal and 100 to 1500ppm/ $^{\circ}$ C for thick film current sensors.
- Scalable off-the-shelf products in standard case sizes.
- Compatibility with surface-mount assembly process.
- RoHS/REACH-compliant & Halogen-free.

The low temperature coefficient of resistance (TCR) of Yageo's current-sensing chip resistors minimizes the resistance change caused by self-heating and high temperature environments.

Thermal electromotive force (EMF) is also an important consideration. Thermal EMF is an important parameter of the metal foil series of battery management circuits, and of current-sensor resistors. Thermal electromotive force (EMF) of an Mn-Cu alloy is especially optimal with low EMF below μ 0.03 uV/ $^{\circ}$ C.



Current-Sensing Circuit Applications

Low-Ohmic Resistors in Power-Sensing

Current-sensor resistors are used in power sensing applications such as sensing output current in power supplies and automotive engine management systems. As shown in Figure 1, a typical function for a current-sensor chip resistor is as a current-sensor (R_{sense}). This generates the sensing voltage (V_s) for a feedback control network through which an output current (I_o) passes. The sensing voltage triggers MOSFET switches, switching them ON and OFF to regulate the duty factor of the current passing through a choke (L).

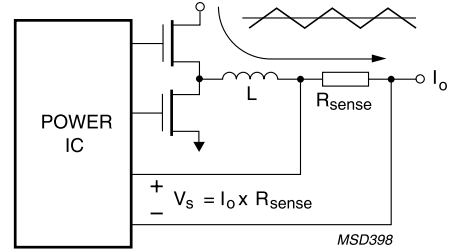

Figure 1 Current sensor chip resistor in current sensing application

The sensing voltage (V_s) is given by the simple relation:

$$V_s = I_o \times R_{sense}$$

This sensing voltage is generally set at around 100 mV both to save power and maintain satisfactory noise immunity. To sense a 5 A average output current, R_{sense} must be $100 \text{ mV} / 5 \text{ A} = 20 \text{ m}\Omega$. The power dissipation will then be:

$$P = I_o^2 R_{sense} = 5 \text{ A} \times 5 \text{ A} \times 20 \text{ m}\Omega = 0.5 \text{ W}$$

A current-sensor chip resistor with a power rating 1.0 W would then be recommended for this application to provide an adequate safety margin.

Over-Current Detection

As a means to detect the current passing through the transistor (see Figure 2), a resistor in series is added between an emitter and a ground. This resistor shouldn't emit smoke or catch fire even when the switching transistor, subjected to a larger current, breaks down. In addition, reduced parasitic inductance is required, particularly for high frequency switching control. Recommended resistors with low resistance are metal-plate types, like the PE-series.

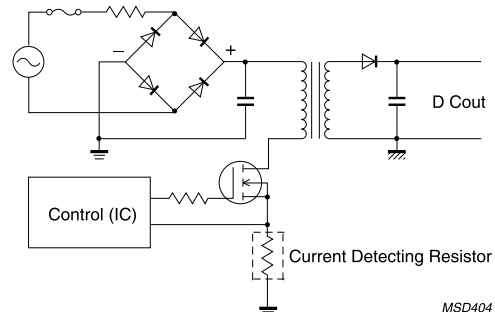

Figure 2 Over-current protection circuit

DC/DC converter

Figure 3 on the right shows the current-detecting circuit of a DC/DC converter. The voltage across the current-detecting resistor is fed back to control the output power. The resistance should be low to reduce power dissipation, and the resistor should withstand a repeated rush current. Furthermore, the self-inductance should be low for high-frequency applications. Recommended types are PE-series chip resistors. As for high frequency DC/DC converters, metal-plate chip resistor, PE-series are the best fit.

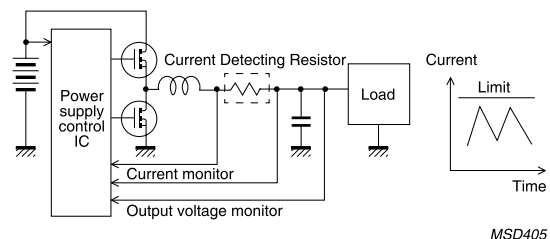

Figure 3 DC/DC converter circuit

Tight Tolerance in Sensing Resistance

The magnitude of the output ripple depends on the inductance of the choke - the higher the inductance, the lower the ripple. A high inductance choke, however, reduces the ability of the circuit to respond to high frequency transients. Such a choke will also be physically large, limiting the possibilities for miniaturization so essential to modern mobile equipment.

A trade-off is therefore necessary between choke volume and output current ripple. Experience indicates that a ripple of 0.04 provides a good compromise in this area. With this ripple value, the peak output current (I_{peak}) is 2% greater than the average current (I_{avg}): $I_{\text{peak}} = 1.02 \times I_{\text{avg}}$ (Figure 4).

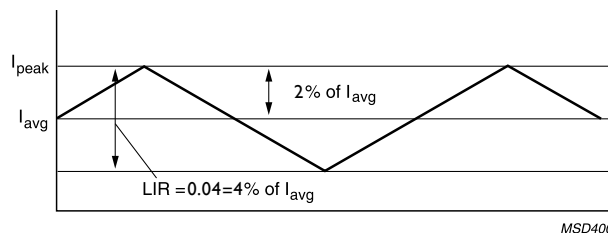

Figure 4 Relationship between average output current and peak current with a ripple of 0.04

The voltage generated across the sensing resistor is used in a feedback network to trigger the power-switching IC. To allow for variation in the characteristics of the power-switching IC, a safety margin for the sensing-voltage is necessary. A -2% margin on sensing-voltage is usually taken for general applications.

As mentioned earlier, the relation between current sensor resistance, feedback sensing voltage and output current is given by the formula: $R_{\text{sense}} = V_s / I_o$. With an output ripple of 0.04, a 4% ($\pm 2\%$) deviation on output current and a safety margin on the sensing voltage of -2%, the allowable deviation on (R_{sense}) is:

$$\frac{0.98 \times V_s}{0.98 \times I_o} \leq R_{\text{sense}} \leq \frac{V_s}{0.85 \times I_o}$$

If $V_s = 100 \text{ mV}$ and $I_o = 5 \text{ A}$, the allowable current sensor sensing resistance must lie in the range $19.2 \text{ m}\Omega$ to $20.4 \text{ m}\Omega$.

Excellent Low TCR Values for Precision Applications

The above discussion does not, of course, take into account the effects of the temperature coefficient of resistance (TCR) on current sensing applications. With a maximum deviation of 4% on output current and a safety margin of 2% on sensing voltage, the maximum allowable deviation on sensing resistance is 6%. The limit on TCR is then given by:

$$R_{\text{sense}} (1 + \text{T.C.R.} \times \Delta T) \leq 1.06 R_{\text{sense}}$$

So

$$\text{TCR} \leq \frac{0.06}{\Delta T} \text{ ppm/K}$$

Figure 3 plots the allowable T.C.R. values required to maintain tolerance on sensing resistance within the specified limit. TCR values of Yageo's current-sensor chip resistors fall well within these allowed limits over the temperature range 25°C to 155°C .



Market Applications

Yageo's current sensor chip resistors are optimized for current sensing control. The current sensor current sensors, available from 0.05 to 5 watts, are applicable to battery pack, power supply and converter, and are suitable for use in diverse power control circuit of notebook computer or the hard disk of other compact portable devices that have current sensing and over current protection requirements. Featuring a comprehensive resistance range of 0.5 milli-ohms to 1 ohm and superior temperature coefficient (T.C.R.) performance is able to meet various customer demands and applications.

Application	Segment				
	Consumer	Automotive	Industrial	Telecom	Medical
Device & Computing					
Home Appliances	v				
Air Conditioners	v	v			
Diagnostic Equipment					v
Infotainment System	v		v		
Smart Meters			v		
Smartphones & Tablets	v			v	
Notebooks	v			v	
Wearable Devices	v		v	v	v
Networking				v	
Batteries					
Battery Chargers	v	v	v	v	v
Battery Life Indicators	v	v	v	v	v
Battery Packs	v	v	v	v	v
Motors					
Motor Controls	v	v	v		
Motor Drives	v	v	v		
Power Supplies					
DC/DC Converters	v		v	v	v
Switch Mode Power Supplies	v	v	v	v	v
LED Lighting					
LED Drivers	v	v	v		v
Ballasts	v	v	v		v
Storage & Cloud Computing					
Disk Drives (HDD &SSD)	v				
Servers	v				

Product Portfolio

Thick Film Current-Sensing Chip Resistors (RL & PT Series)

Based on thick film technology, these products exhibit far low parasitic inductance than wirewound and leaded counter parts. Yageo's thick film RL/PT low-ohmic current sensing chip resistors is low cost, capable of providing low TCR down to $\pm 75\text{ppm}/^\circ\text{C}$, resistance value down to $50\text{m}\Omega$ with power up to 2 watts of power dissipation.

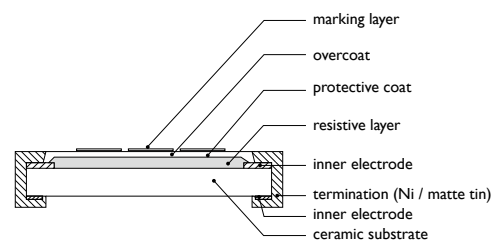

Cross section of RL / PT series

Metal Foil Current-Sensing Chip Resistors (PE & PF Series)

Metal foil current-sensing resistors made of Mn-Cu alloy are developed with substrates to provide a better thermal dissipation and with a wider resistance range up to $300\text{m}\Omega$. Metal foil PE series feature low EMF below conditions of temperature changes. $0.03\ \mu\text{V}/^\circ\text{C}$ is more likely to endure harsh conditions. In the metal foil type, TCR ranges from 50 to $100\text{ppm}/^\circ\text{C}$, power rates up to 3W, and resistance value is available as low as $0.5\text{m}\Omega$.

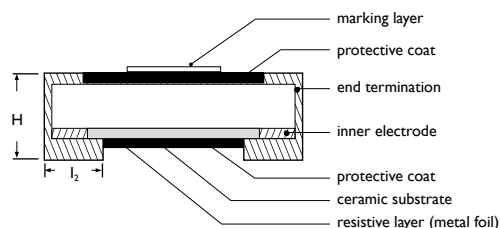

Cross section of PE / PF series

Metal Plate Current-Sensing Chip Resistors (PA & PR Series)

A related simple construction without multiple cuts, metal plate current-sensing resistors provide low TCR down to $\pm 25\text{ppm}/^\circ\text{C}$, high power rating up to 3W, high frequency performance and low resistance down to $0.5\text{m}\Omega$.

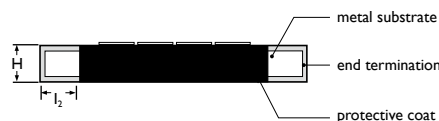

Cross section of PA / PR series

Wide Terminal Current-Sensing Chip Resistors

Using the wider side as connection in the mounting plate, wide terminal current-sensing chip resistors strengthen solder joints, holding reliably to achieve higher power rating needs. With an ideal structure to suppress heat generation, wide terminal type current-sensors save space, and reduce resistor numbers in high-density circuit board designs.

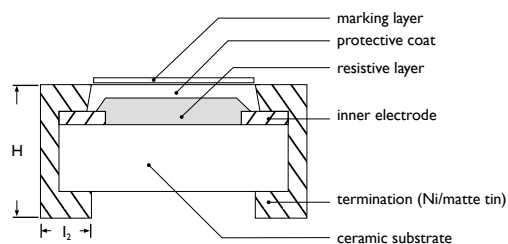

Cross section of wide terminal series

Four-Terminal, Current-Sensing Chip Resistors

Design of accurate measurement circuitry, lower power consumption, higher accuracy, and smaller space requirements are important features for electronic control units. To minimize power losses, a large current across the (R_{sense}) resistor needs to be measured, and high-side, current-sense amplifier ICs have to monitor the current accurately. Four-terminal, current-sensing resistors separating current-carry from voltage-sensing terminals are able to improve voltage and current measurement accuracy from the ideal Kelvin configuration. They also improve interference and thermoelectric effects at higher applied power.



Dimensions

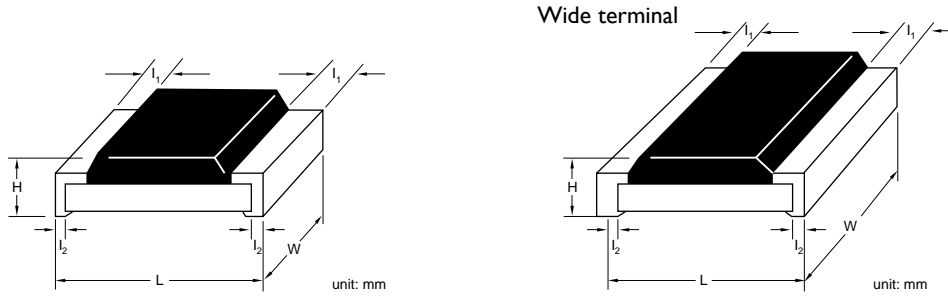

Type	Resistance range	L	W	H	I ₁	I ₂
RL0402 ⁽¹⁾	50mΩ ≤ R < 1Ω	1.00 ± 0.10	0.50 ± 0.05	0.35 ± 0.05	0.20 ± 0.10	0.25 ± 0.10
RL0603 ⁽¹⁾	10mΩ ≤ R < 1Ω	1.60 ± 0.10	0.80 ± 0.10	0.45 ± 0.10	0.25 ± 0.15	0.25 ± 0.15
RL0805 ⁽¹⁾		2.00 ± 0.10	1.25 ± 0.10	0.50 ± 0.10	0.35 ± 0.20	0.35 ± 0.20
RL1206 ⁽¹⁾		3.10 ± 0.10	1.60 ± 0.10	0.55 ± 0.10	0.45 ± 0.20	0.45 ± 0.20
RL1210 ⁽¹⁾		3.10 ± 0.10	2.60 ± 0.15	0.55 ± 0.10	0.50 ± 0.20	0.50 ± 0.20
RL1218 ⁽¹⁾		3.05 ± 0.15	4.60 ± 0.20	0.55 ± 0.10	0.45 ± 0.25	0.50 ± 0.25
RL2010 ⁽¹⁾		5.00 ± 0.10	2.50 ± 0.15	0.55 ± 0.10	0.60 ± 0.20	0.50 ± 0.20
RL2512 ⁽¹⁾		6.35 ± 0.10	3.20 ± 0.15	0.55 ± 0.10	0.60 ± 0.20	0.50 ± 0.20
PT0402 ⁽¹⁾		50mΩ ≤ R < 1Ω	1.00 ± 0.10	0.50 ± 0.05	0.35 ± 0.05	0.20 ± 0.10
PT0603 ⁽¹⁾	1.60 ± 0.10		0.80 ± 0.10	0.45 ± 0.10	0.25 ± 0.15	0.25 ± 0.15
PT0805 ⁽¹⁾	2.00 ± 0.10		1.25 ± 0.10	0.55 ± 0.10	0.35 ± 0.20	0.35 ± 0.20
PT1206 ⁽¹⁾	50mΩ ≤ R < 75mΩ & 91mΩ ≤ R < 1Ω	3.10 ± 0.10	1.60 ± 0.10	0.55 ± 0.10	0.45 ± 0.20	0.45 ± 0.20
	75mΩ ≤ R < 91mΩ	3.10 ± 0.10	1.60 ± 0.10	0.55 ± 0.10	0.75 ± 0.20	0.45 ± 0.20
PT2010 ⁽¹⁾	100mΩ ≤ R < 1Ω	5.00 ± 0.10	2.50 ± 0.15	0.55 ± 0.10	0.60 ± 0.20	0.50 ± 0.20
PT2512 ⁽¹⁾		6.35 ± 0.10	3.20 ± 0.15	0.55 ± 0.10	0.60 ± 0.20	0.50 ± 0.20
PE0402 ⁽²⁾	10mΩ ≤ R ≤ 50mΩ	1.00 ± 0.30	0.50 ± 0.20	0.45 ± 0.20	---	0.25 ± 0.10
PE0603 ⁽²⁾	5mΩ ≤ R < 100mΩ	1.60 ± 0.25	0.80 ± 0.25	0.60 ± 0.25	---	0.30 ± 0.25
PE0805 ⁽²⁾	4mΩ	2.00 ± 0.25	1.25 ± 0.25	0.60 ± 0.25	---	0.70 ± 0.25
	5mΩ					0.63 ± 0.25
	6mΩ					0.55 ± 0.25
	7mΩ ≤ R < 100mΩ					0.40 ± 0.25
PE1206 ⁽²⁾	4mΩ	3.20 ± 0.25	1.60 ± 0.25	0.60 ± 0.25	---	1.20 ± 0.25
	5mΩ ≤ R ≤ 8mΩ					1.15 ± 0.25
	9mΩ ≤ R < 100mΩ					0.58 ± 0.25
PE2010 ⁽²⁾	5mΩ ≤ R ≤ 9mΩ	5.00 ± 0.25	2.50 ± 0.25	0.60 ± 0.25	---	1.50 ± 0.25
	10mΩ ≤ R < 100mΩ					0.60 ± 0.25
PE2512 ⁽²⁾	6mΩ ≤ R ≤ 8mΩ	6.30 ± 0.25	3.10 ± 0.25	0.60 ± 0.25	---	1.90 ± 0.25
	9mΩ ≤ R < 99mΩ					0.95 ± 0.25
	100mΩ	6.45 ± 0.25	3.25 ± 0.25	0.70 ± 0.25	---	0.60 ± 0.25

Note: 1. Apply to ordering codes ending in "L"

2. Apply to ordering codes ending in "Z"

Please contact sales offices, distributors and representatives in your region before ordering

Type	Resistance range	L	W	H	I ₁	I ₂
PE4527 ⁽²⁾	5mΩ	11.50 ± 0.25	7.00 ± 0.25	0.60 ± 0.25	---	2.90 ± 0.25
	6mΩ ≤ R < 910mΩ					2.60 ± 0.25
PR1206 ⁽²⁾	1mΩ ≤ R ≤ 4mΩ	3.20 ± 0.25	1.60 ± 0.25	0.64 ± 0.25	0.50 ± 0.25	0.50 ± 0.25
PR2010 ⁽²⁾	1mΩ ≤ R ≤ 3mΩ	5.10 ± 0.25	2.54 ± 0.25	0.80 ± 0.25	1.30 ± 0.25	1.30 ± 0.25
	4mΩ	5.10 ± 0.25	2.54 ± 0.25	0.64 ± 0.25	0.80 ± 0.25	0.80 ± 0.25
PA2512 ⁽¹⁾	1mΩ ≤ R ≤ 5mΩ	6.50 ± 0.20	3.20 ± 0.20	0.65 ± 0.15	0.90 ± 0.20	0.90 ± 0.20

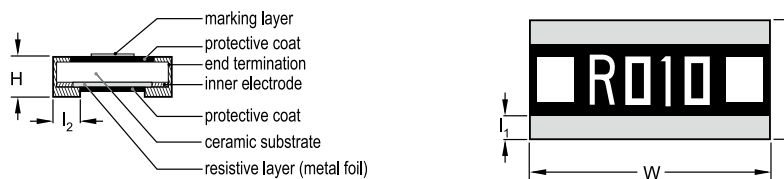
Wide terminal

Type	Resistance range	L	W	H	I ₁	I ₂
PE0306 ⁽²⁾	5mΩ ≤ R ≤ 100mΩ	0.90 ± 0.20	1.70 ± 0.20	0.65 ± 0.20	0.25 ± 0.15	0.25 ± 0.15
PE0508 ⁽²⁾	3mΩ ≤ R ≤ 100mΩ	1.35 ± 0.20	2.10 ± 0.20	0.65 ± 0.20	0.43 ± 0.15	0.43 ± 0.15
PE0612 ⁽²⁾	1mΩ	1.60 ± 0.20	3.20 ± 0.20	0.60 ± 0.15	0.55 ± 0.20	0.55 ± 0.20
	2mΩ ≤ R ≤ 4mΩ	1.60 ± 0.20	3.20 ± 0.20	0.60 ± 0.15	0.40 ± 0.20	0.40 ± 0.20
	5mΩ ≤ R ≤ 300mΩ	1.60 ± 0.20	3.20 ± 0.20	0.60 ± 0.15	0.30 ± 0.20	0.30 ± 0.20
PE0815 ⁽²⁾	1mΩ	2.50 ± 0.20	3.70 ± 0.20	0.60 ± 0.15	0.95 ± 0.20	0.95 ± 0.20
	2mΩ	2.50 ± 0.20	3.70 ± 0.20	0.60 ± 0.15	0.75 ± 0.20	0.75 ± 0.20
	3mΩ ≤ R ≤ 100mΩ	2.50 ± 0.20	3.70 ± 0.20	0.60 ± 0.15	0.60 ± 0.20	0.60 ± 0.20
PE0830 ⁽²⁾	6 / 8 / 10mΩ	2.00 ± 0.20	7.50 ± 0.30	0.60 ± 0.15	0.60 ± 0.15	0.60 ± 0.15
	1mΩ ≤ R ≤ 100mΩ (except 6/8/10mΩ)	2.50 ± 0.20	7.50 ± 0.30	0.60 ± 0.15	0.58 ± 0.15	0.58 ± 0.15
PE1225 ⁽²⁾	1mΩ	3.10 ± 0.20	6.30 ± 0.20	0.60 ± 0.15	1.15 ± 0.20	1.15 ± 0.20
	2mΩ ≤ R ≤ 100mΩ	3.10 ± 0.20	6.30 ± 0.20	0.60 ± 0.15	0.50 ± 0.20	0.50 ± 0.20

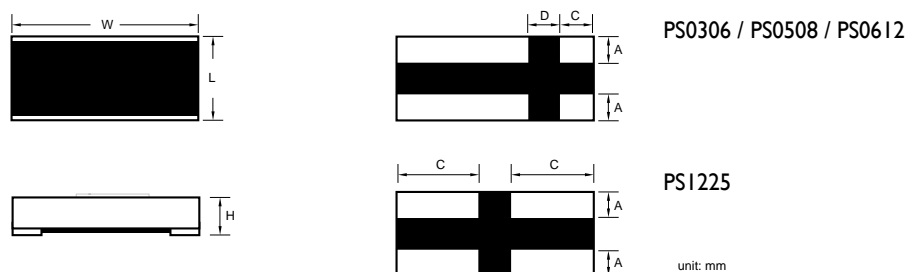
4 terminal

Type	Resistance range	L	W	A	D	C	H
PS0306	10mΩ ≤ R ≤ 50mΩ	0.80 ± 0.20	1.60 ± 0.20	0.25 ± 0.20	0.30 ± 0.15	0.30 ± 0.15	0.55 ± 0.20
PS0508	10mΩ ≤ R ≤ 50mΩ	1.25 ± 0.20	2.00 ± 0.20	0.25 ± 0.20	0.20 ± 0.15	0.30 ± 0.20	0.55 ± 0.20
PS0612 ⁽²⁾	0.5mΩ ≤ R ≤ 100mΩ	1.60 ± 0.20	3.20 ± 0.20	0.45 ± 0.20	0.50 ± 0.20	0.65 ± 0.20	0.60 ± 0.20
PS1225 ⁽²⁾	3mΩ ≤ R ≤ 100mΩ	3.10 ± 0.20	6.30 ± 0.20	0.80 ± 0.20	---	2.20 ± 0.20	0.60 ± 0.15

Note: 1. Apply to ordering codes ending in "L"

2. Apply to ordering codes ending in "Z"

Please contact sales offices, distributors and representatives in your region before ordering



Product Selection Tables

T. C. R. - RL series						
Type	T.C.R					
	50mΩ ≤ R < 100mΩ	100mΩ ≤ R < 500mΩ		500mΩ ≤ R < 1Ω		
RL0402	±1000 ppm/°C	±800 ppm/°C		±300 ppm/°C		
	10mΩ ≤ R ≤ 36mΩ	36mΩ < R ≤ 91mΩ		91mΩ < R ≤ 500mΩ	500mΩ < R < 1Ω	
RL0603	±1 500 ppm/°C	±1 200 ppm/°C		±800 ppm/°C	±300 ppm/°C	
	10mΩ ≤ R ≤ 18mΩ	18mΩ < R ≤ 47mΩ	47mΩ < R ≤ 91mΩ	91mΩ < R ≤ 360mΩ	360mΩ < R ≤ 500mΩ	500mΩ < R < 1Ω
RL0805 / RL1206 / RL2010	±1 500 ppm/°C	±1 200 ppm/°C	±1 000 ppm/°C	±600 ppm/°C	±300 ppm/°C	±200 ppm/°C
RL1210	±1 500 ppm/°C	±1 000 ppm/°C	±800 ppm/°C	±600 ppm/°C	±300 ppm/°C	±200 ppm/°C
RL2512	±1 500 ppm/°C	±1 200 ppm/°C	±800 ppm/°C	±600 ppm/°C	±300 ppm/°C	±200 ppm/°C
	10mΩ ≤ R ≤ 30mΩ	30mΩ < R ≤ 56mΩ		56mΩ < R ≤ 180mΩ		180mΩ < R < 1Ω
RL1218	±2 000 ppm/°C	±1 000 ppm/°C		±700 ppm/°C		±250 ppm/°C

Electrical characteristics								
Global part number	Series	Size	Power rating	Max. voltage	Operating Temp. range	Resistance range	Tol.	T. C. R.
RL0402xR-07xxxxL	RL	0402	1/16W	(PxR) ^{1/2}	-55°C to 125°C	50mΩ ≤ R < 1Ω	±1% ±2% ±5%	Pls refer to above table "T. C. R. - RL series"
RL0603xR-07xxxxL		0603	1/10W					
RL0805xR-07xxxxL		0805	1/8W					
RL0805xR-7WxxxxL			1/4W					
RL1206xR-07xxxxL		1206	1/4W					
RL1206xR-7WxxxxL			1/2W					
RL1210xR-07xxxxL		1210	1/2W					
RL1218xK-07xxxxL		1218	1W					
RL2010xK-07xxxxL		2010	3/4W					
RL2512xK-07xxxxL		2512	1W					
PT0402xRx07xxxxL	PT	0402	1/16W	(PxR) ^{1/2}	-55°C to 155°C	50mΩ ≤ R < 1Ω	±1% ±2% ±5%	50mΩ ≤ R < 68mΩ ± 600 ppm/°C 68mΩ ≤ R < 100Ω ± 300 ppm/°C 100mΩ ≤ R < 1Ω ± 200 ppm/°C
PT0402xRx7WxxxxL			1/8W					
PT0402xRx7TxxxxL			1/6W					
PT0603xRx07xxxxL		0603	1/10W					50mΩ < R < 68mΩ 0/+400 ppm/°C 50mΩ ≤ R < 100Ω 0/+350 ppm/°C 68mΩ ≤ R < 100Ω 0/+300 ppm/°C 100mΩ ≤ R < 1Ω ±200 ppm/°C
PT0603xRx7WxxxxL			1/5W					
PT0603xRx7TxxxxL			1/3W					
PT0805xR-07xxxxL		0805	1/8W			50mΩ ≤ R < 1Ω		50mΩ < R < 68mΩ 0/+350 ppm/°C 50mΩ ≤ R < 100Ω 0/+300 ppm/°C 68mΩ ≤ R < 100Ω 0/+250 ppm/°C 100mΩ ≤ R < 1Ω ±100 ppm/°C
PT0805xR-7WxxxxL			1/4W					
PT1206xR-07xxxxL		1206	1/4W					50mΩ ≤ R < 75mΩ ±350ppm/°C 75mΩ ≤ R ≤ 100mΩ ±100ppm/°C 100mΩ < R < 1Ω ±75ppm/°C
PT1206xR-7WxxxxL			1/2W					

Global part number	Series	Size	Power rating	Max. voltage	Operating Temp. range	Resistance range	Tol.	T. C. R.													
PT2010xK-07xxxxL	PT	2010	3/4W	(PxR) ^{1/2}	-55°C to 155°C	100mΩ ≤ R < 1Ω	±1% ±2% ±5%	100mΩ < R < 1Ω	±100 ppm/°C ±75 ppm/°C												
PT2010xK-7WxxxxL			1W					100mΩ < R < 1Ω	±100 ppm/°C ±75 ppm/°C												
PT2512xK-07xxxxL		2512	1W			100mΩ ≤ R < 1Ω		100mΩ < R < 1Ω	±100 ppm/°C ±75 ppm/°C												
PT2512xK-7WxxxxL			2W					100mΩ < R < 1Ω	±100 ppm/°C ±75 ppm/°C												
PE0402xRx07xxxxxx	PE	0402	1/16W	(PxR) ^{1/2}	-55°C to 155°C	10mΩ ≤ R ≤ 50mΩ	±1% ±5%	±100 ppm/°C													
PE0402xRx7Wxxxxxx			1/8W					±100 ppm/°C													
PE0402xRx47xxxxxx			1/4W					±100 ppm/°C													
PE0603xRx07xxxxxx		0603	1/10W		-55°C to 170°C	5mΩ ≤ R ≤ 100mΩ		±1% ±5%	±50 ppm/°C ±75 ppm/°C ±100 ppm/°C	±100 ppm/°C											
PE0603xRx7Wxxxxxx			1/5W							±100 ppm/°C											
PE0603xRx7Txxxxxx			1/3W							±100 ppm/°C											
PE0603xRx47xxxxxx			2/5W							±100 ppm/°C											
PE0603xRx57xxxxxx			1/2W							±100 ppm/°C											
PE0805xRx07xxxxxx		0805	1/8W		-55°C to 170°C	3mΩ ≤ R ≤ 100mΩ				±1% ±5%	±50 ppm/°C ±75 ppm/°C ±100 ppm/°C	±100 ppm/°C									
PE0805xRx7Wxxxxxx			1/4W									±100 ppm/°C									
PE0805xRx7Txxxxxx			1/3W									±100 ppm/°C									
PE0805xRx47xxxxxx			1/2W									±100 ppm/°C									
PE1206xxx07xxxxxx		1206	1/4W		-55°C to 170°C	3mΩ ≤ R ≤ 100mΩ						±1% ±5%	±50 ppm/°C ±75 ppm/°C ±100 ppm/°C	±100 ppm/°C							
PE1206xxx7Wxxxxxx			1/2W											±100 ppm/°C							
PE1206xxx47xxxxxx			1W											±100 ppm/°C							
PE2010xKx07xxxxxx		2010	1/2W		-55°C to 170°C	5mΩ ≤ R ≤ 100mΩ								±1% ±5%	±50 ppm/°C ±75 ppm/°C ±100 ppm/°C	±100 ppm/°C					
PE2010xKx7Wxxxxxx			1W													±100 ppm/°C					
PE2512xKx07xxxxxx		2512	1W		-55°C to 170°C	6mΩ ≤ R ≤ 100mΩ										±1% ±5%	±50 ppm/°C ±75 ppm/°C ±100 ppm/°C	±100 ppm/°C			
PE2512xKx7Wxxxxxx			2W															±100 ppm/°C			
PE4527xKx07xxxxxx		4527	2W		-55°C to 170°C	5mΩ ≤ R < 910mΩ												±1% ±5%	±50 ppm/°C ±75 ppm/°C ±100 ppm/°C	±100 ppm/°C	
PE4527xKx7Wxxxxxx	3W		±100 ppm/°C																		
PR1206xKx07xxxxxx	PR	1206	1/4W	(PxR) ^{1/2}	-55°C to 170°C	1mΩ ≤ R ≤ 4mΩ	±1% ±5%													±50 ppm/°C	
PR1206xKx7Wxxxxxx			1/2W																	±50 ppm/°C	
PR1206xKx47xxxxxx			1W					±50 ppm/°C													
PR2010xKx07xxxxxx		2010	1/2W			1mΩ ≤ R < 4mΩ		±50 ppm/°C													
PR2010xKx7Wxxxxxx			1W					±50 ppm/°C													
PA2512xKF07xxxxL	PA	2512	1W	(PxR) ^{1/2}	-55°C to 155°C	1mΩ ≤ R ≤ 5mΩ	±1% ±5%	±100 ppm/°C													
PA2512xKF7WxxxxL			2W					±100 ppm/°C													
PA2512xKF7TxxxxL			3W					±100 ppm/°C													



Wide terminal								
Global part number	Series	Size	Power rating	Max. voltage	Operating Temp. range	Resistance range	Tol.	T. C. R.
PE0306xRM07xxxxx	PE	0306	1W	(PxR) ^{1/2}	-55°C to 170°C	5mΩ ≤ R ≤ 100mΩ	±1% ±5%	±75 ppm/°C ±100 ppm/°C
PE0508xRM07xxxxx		0508	1.2W			3mΩ ≤ R ≤ 100mΩ		
PE0612xKM7Wxxxxx		0612	2W			1mΩ ≤ R ≤ 300mΩ		
PE0815xKM7Wxxxxx		0815	1W			1mΩ ≤ R ≤ 100mΩ		
PE0830xKM7Wxxxxx		0830	3W			1mΩ ≤ R ≤ 100mΩ		
PE1225xKM7Wxxxxx		1225	3W			1mΩ ≤ R ≤ 100mΩ		
4 terminal								
Global part number	Series	Size	Power rating	Max. voltage	Operating Temp. range	Resistance range	Tol.	T. C. R.
PS0306xRx07xxxxx	PS	0306	1/8W	(PxR) ^{1/2}	-55°C to 155°C	10mΩ ≤ R ≤ 50mΩ	±1% ±5%	±75 ppm/°C ±100 ppm/°C
PS0306xRx7Wxxxxx			1/4W		-55°C to 170°C			
PS0508xRx07xxxxx		0508	1/8W					
PS0508xRx7Wxxxxx			1/4W					
PS0508xRx7Txxxxx		1/2W						
PS0612xKM07xxxxx		0612	1W		0.5mΩ, 0.75mΩ 1mΩ ≤ R ≤ 5mΩ			
PS1225xKM07xxxxx	1225	3W	4mΩ ≤ R ≤ 50mΩ	±75 ppm/°C ±100 ppm/°C				

Jumper					
Global part number	Series	Size	Operating Temp. range	Max. Resistance	Rated Current
RL0402-R-070RL	RL	0402	-55°C to 155°C	20mΩ	1.5A
RL0603-R-070RL		0603		20mΩ	2A
RL0805-R-070RL		0805		20mΩ	2.5A
RL1206-R-070RL		1206		20mΩ	3.5A
PT0402-R-070RL	PT	0402	-55°C to 155°C	10mΩ	3A
PT0603-R-070RL		0603		8mΩ	5A
PT0805-R-070RL		0805		5mΩ	6A
PT1206-R-070RL		1206		5mΩ	10A

Environmental characteristics

Performance test		Test method	Procedure	Requirements
Life		MIL-STD-202G-method 108A	1 000 hours at 70°C ±5°C applied RCWV 1.5 hours on, 0.5 hours off, still air required	±(1%+ 0.0005Ω) <20mΩ for jumper
High temperature exposure		MIL-STD-202G-method 108A	1 000 hours at maximum operating temperature depending on specification, unpowered	±(1%+ 0.0005Ω) <20mΩ for jumper
Moisture resistance		MIL-STD-202G-method 106F	Each temperature / humidity cycle is defined as 8 hours (method 106F), 3 cycles / 24 hours for 10d with 25°C / 65°C 95% R.H	±(0.5%+ 0.0005Ω) <20mΩ for jumper
Solderability	Wetting	IPC/JEDECJ-STD-002B testB	Electrical test not required. Magnification 50X Lead-free solder bath at 245 ±3°C Dipping time: 3 ±0.5 seconds	Well tinned (≥95% covered) No visible damage
	Resistance to soldering heat	MIL-STD-202G-method 210F	Lead-free solder, 260°C, 10 seconds immersion time	±(0.5%+ 0.0005Ω) <10mΩ for jumper No visible damage
Short time overload		MIL-R-55342D-para 4.7.5	PT/RL standard power: 6.25 times of rated power for 5 seconds at room temperature PA/PR/PE/PS & PT/RL high power: 5 times of rated power for 5 seconds at room temperature PT/RL jumper: 2.5 times of rated current for 5 seconds at room temperature	±(1%+ 0.0005Ω) <10mΩ for jumper No visible damage

Packing quantities

Size code	Tape width	178mm / Ø7" reel		330mm / Ø13" reel
		Paper	Embossed	Paper
0306	8mm	5 000	---	---
0402	8mm	10 000	---	50 000 ⁽¹⁾
0508	8mm	5 000	---	---
0603	8mm	5 000	---	20 000 ⁽¹⁾
0612	8mm	---	5 000	---
0805	8mm	5 000	---	20 000 ⁽¹⁾
0815	8mm	---	4 000	---
0830	16mm	---	4 000	---
1206	8mm	5 000	4 000	20 000 ⁽¹⁾
1210	8mm	5 000	---	20 000 ⁽¹⁾
1218	12mm	---	4 000	---
1225	12mm	---	4 000	---
2010	12mm	---	4 000 / 2 000 ⁽²⁾	---
2512	12mm	---	4 000	---
4527	24mm	---	1 000	---

Note: (1) RL/PT series only

(2) PR series with ordering code ending in "Z"



Explanation of ordering code

P T 2 5 1 2 F K - 0 7 0 R 1 L

Series name (code 1-2)

RL = Thick film current sensor
 PT = Thick film current sensor low T. C. R.
 PA/PR/PE =
 Current sensor - low T. C. R.
 PS = 4 terminal, Current sensor

Size code (inch / metric) (code 3-6)

0306 = 0.8 x 1.6 1206 = 3.2 x 1.6
 0402 = 1.0 x 0.5 1210 = 3.2 x 2.5
 0508 = 1.25 x 2.0 1218 = 3.2 x 4.5
 0603 = 1.6 x 0.8 1225 = 3.2 x 6.3
 0612 = 1.6 x 3.2 2010 = 5.0 x 2.5
 0805 = 2.0 x 1.25 2512 = 6.35 x 3.2
 0815 = 2.15 x 3.75 4527 = 11.0 x 7.0
 0830 = 2.0 x 7.5

Tolerance (code 7)

F = ±1%
 G = ±2%
 J = ±5%
 “-” for Jumper ordering

Packing style (code 8)

R = Paper tape reel
 K = Embossed plastic tape reel

Default Code (code 17)

L / Z = Default code

Resistance (code 12-16)

There are 2~5 digits indicated the resistance value. Letter R is decimal point.

Ex:

OR = Jumper
 OR1 = 0.1Ω
 OR01 = 0.01Ω
 OR001 = 0.001Ω
 OU5 = 0.0005Ω

Taping Reel (code 10-11)

07 = 7 inch Dia. reel
 13 = 13 inch Dia. reel
 7W = 7 inch Dia. reel 2 x standard power type
 7T = 7 inch Dia. reel 3 x standard power type
 47 = 7 inch Dia. reel 4 x standard power type
 57 = 7 inch Dia. reel 5 x standard power type

T.C.R (code 9)

E = ±50 ppm/°C
 M = ±75 ppm/°C
 F = ±100 ppm/°C
 “-” Based on spec. (- for RL/PT only)

Cross reference

Yageo	Vishay	Rohm	KOA	Cyntec	TT/IRC	Susumu	Features
RL/PT Series	D..LR/ CRCW,RCWE	UCR	SR73/ UR73	RLT	LRC, LRF, LVC	RLT	Thick Film 0402~2512, 0R05~0R91, Current sensing
PR/PE Series	WSL/WSLP	PMR/PML	TLR	RLT	ULR, LVC	KRL, RL	Metal Alloy, 0402~4527, 0R001~0R1, low TCR, used in middle/high power
PT0402	RCWE0402	UCR01	SR73IE	RLT0510	LVC0402	RLT0510	0402, 0R1~0R91 Thick Film current sensing
PE0603	WSL0603	PMR03	-	RL0816	-	-	0603, 0R005~0R1, TC75, Metal Foil, current sensing
PE0805	WSL0805	PMR10	-	RL1220	-	-	0805, 0R003~0R1, TC75, Metal Foil, current sensing
PE4527	WSR2/3/5	-	SL2/ SLN2	-	-	-	Metal Alloy, 4527, 5W, low TCR, high power current sensing

Customer Support & Distribution Network

We bring to the market a proven innovative tradition and a commitment to service second to none.

Yageo sales representatives are available to visit you to discuss the technical and commercial issues appropriate to your project or requirement. Customer service can initiate new orders, change orders, request air shipments or drop shipments, product samples, and generally support your business on a day to day basis.

Our sales/services offices are strategically located to serve our customers worldwide and our international distributor network improves our product availability, delivery lead time and our service anywhere in the world.

Please see the back cover for contact details of your local Yageo organization.

We support our customers with extensive literature including datasheets, brochures and application notes, which are also available electronically on our website at: **www.yageo.com**

In addition, our field application engineers constantly strive wherever possible, to work closely with customers to aid them with design-in and provide them with the support they need to remain competitive in their markets.

Disclaimer

All product specifications, statements, information and data (collectively, the "Information") are subject to change without notice.

All Information given herein is believed to be accurate and reliable, but is presented without guarantee, warranty, or responsibility of any kind, expressed or implied.

Statements of suitability for certain applications are based on our knowledge of typical operating conditions for such applications, but are not intended to constitute -and we specifically disclaim-any warranty concerning suitability for a specific customer application or use. This Information is intended for use only by customers who have the requisite experience and capability to determine the correct products for their application. Any technical advice inferred from this Information or otherwise provided by us with reference to the use of our products is given gratis, and we assume no obligation or liability for the advice given or results obtained.

Although we design and manufacture our products to the most stringent quality and safety standards, given the current state of the art, isolated component failures may still occur. Accordingly, customer applications which require a high degree of reliability or safety should employ suitable designs or other safeguards (such as installation of protective circuitry or redundancies) in order to ensure that the failure of an electrical component does not result in a risk of personal injury or property damage.

Although all product-related warnings, cautions and notes must be observed, the customer should not assume that all safety measures are indicated or that other measures may not be required.



YAGEO - A GLOBAL COMPANY

HQ

Taipei, Taiwan
Tel. +886 2 6629 9999
Fax. +886 2 6628 8886
Mail: sales_tw@yageo.com

China and ASIA

Suzhou, China

Tel. +86 512 6825 5568
Fax. +86 512 6825 5386
Mail: sales_sz@yageo.com

Qingdao, China

Tel. +86 532 8797 0533
Fax. +86 532 8797 0533
Mail: sales_sq@yageo.com

Dongguan, China

Tel. +86 769 8772 0275
Fax. +86 769 8791 0053
Mail: sales_dg@yageo.com

Tokyo, Japan

Tel. +81 3 6809 3972
Fax. +81 3 6809 3982
Mail: sales_yj@yageo.com

Seongnam, Korea

Tel. +82 31 712 4797
Fax. +82 31 712 5866
Mail: sales_yk@yageo.com

Singapore

Tel. +65 6244 7800
Fax. +65 6244 4943
Mail: sales_ysa@yageo.com

Kuala Lumpur, Malaysia

Tel. +60 3 8063 8864
Fax. +60 3 8063 7376
Mail: sales_ysa@yageo.com

Penang, Malaysia

Tel. +60 4 3973049
Fax. +60 4 3973050
Mail: sales_ysa@yageo.com

EUROPE

Munich, Germany

Tel. +49 8990 7784 380
Fax. +49 8990 7784 379
Mail: sales_ym@yageo.com

Milan, Italy

Tel. +39 02 6129 1017
Fax. +39 02 6601 7490
Mail: sales_ym@yageo.com

Roermond, Benelux

Tel. +31 475 385 555
Fax. +31 475 385 589
Mail: sales_ym@yageo.com

Szombathely, Hungary

Tel. +36 94 517 702
Fax. +36 94 517 701
Mail: sales_ym@yageo.com

Moscow, Russian Federation

Tel. +7 965 408 1811
Fax. +7 498 610 0707
Mail: sales_ym@yageo.com

NORTH AMERICA

San Jose, U.S.A.

Tel. +1 408 240 6200
Fax. +1 408 240 6201
Mail: sales_ya@yageo.com

Mexico

Tel. +52 33 31330631
Fax. +1 408 240 6201
Mail: sales_ya@yageo.com

For a complete listing of all Yageo sales offices, distributors, and representatives, please visit "contact us" at www.yageo.com

© YAGEO Corporation



All rights are reserved. Reproduction in whole or in part is prohibited without the prior written consent of the copyright owner.

The information presented in this document does not form part of any quotation or contract, is believed to be accurate and reliable and may be changed without notice.







No liability will be accepted by the publisher for any consequence of its use. Publication thereof does not convey nor imply any license under patent or other industrial or intellectual property rights.

Looking for pricing, stock, or lifecycle information?

Click below to explore more details on WIN SOURCE:

-  [View PT0402FR-070R1L on WIN SOURCE](#)
-  [Yageo Information](#)

Optimize Your Supply Chain with WIN SOURCE Solutions

-  Global Sourcing Solution
-  Obsolete Management
-  Cost Control Management
-  Shortage Management
-  Alternative Solution
-  Excess Inventory Management