



**THE DATASHEET OF
PS2501L-1-A**





PHOTOCOUPLER

PS2501-1,-4,PS2501L-1,-4

HIGH ISOLATION VOLTAGE SINGLE TRANSISTOR TYPE MULTI PHOTOCOUPLER SERIES

–NEPOC Series–

DESCRIPTION

The PS2501-1, -4 and PS2501L-1, -4 are optically coupled isolators containing a GaAs light emitting diode and an NPN silicon phototransistor.

The PS2501-1, -4 are in a plastic DIP (Dual In-line Package) and the PS2501L-1, -4 are lead bending type (Gull-wing) for surface mount.

FEATURES

- High isolation voltage ($BV = 5\,000\text{ Vr.m.s.}$)
- High collector to emitter voltage ($V_{CE0} = 80\text{ V}$)
- High-speed switching ($t_r = 3\ \mu\text{s TYP.}$, $t_f = 5\ \mu\text{s TYP.}$)
- Ordering number of tape product: PS2501L-1-F3: 2 000 pcs/reel
- Safety standards
 - UL approved: No. E72422

APPLICATIONS

- Power supply
- Telephone/FAX.
- FA/OA equipment
- Programmable logic controller

PIN CONNECTION (Top View)

PS2501-1, PS2501L-1

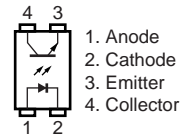

PS2501-4, PS2501L-4

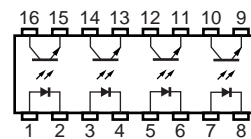

The information in this document is subject to change without notice. Before using this document, please confirm that this is the latest version.

★ **PACKAGE DIMENSIONS (UNIT : mm)**

DIP Type

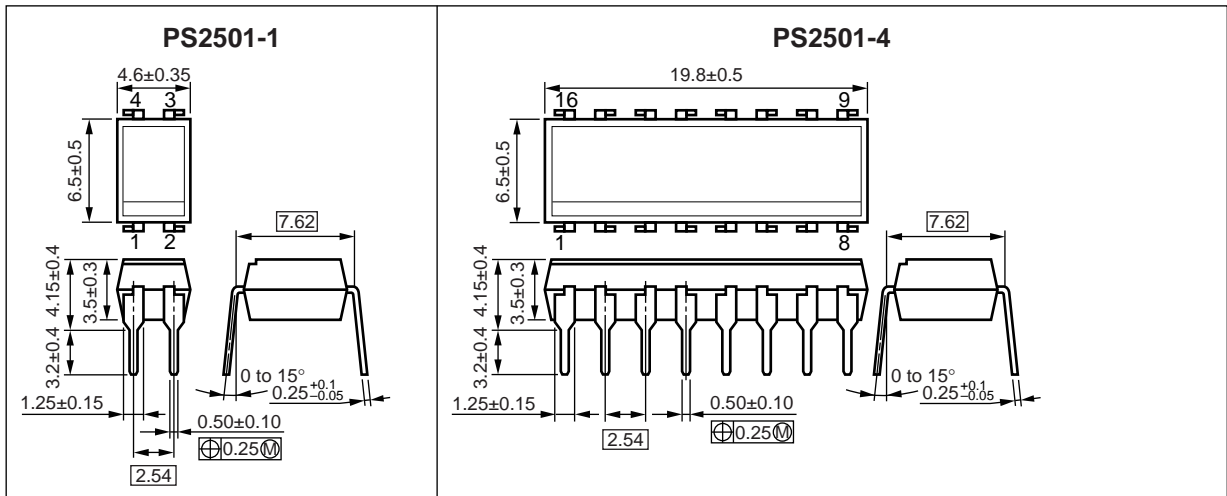

Lead Bending Type

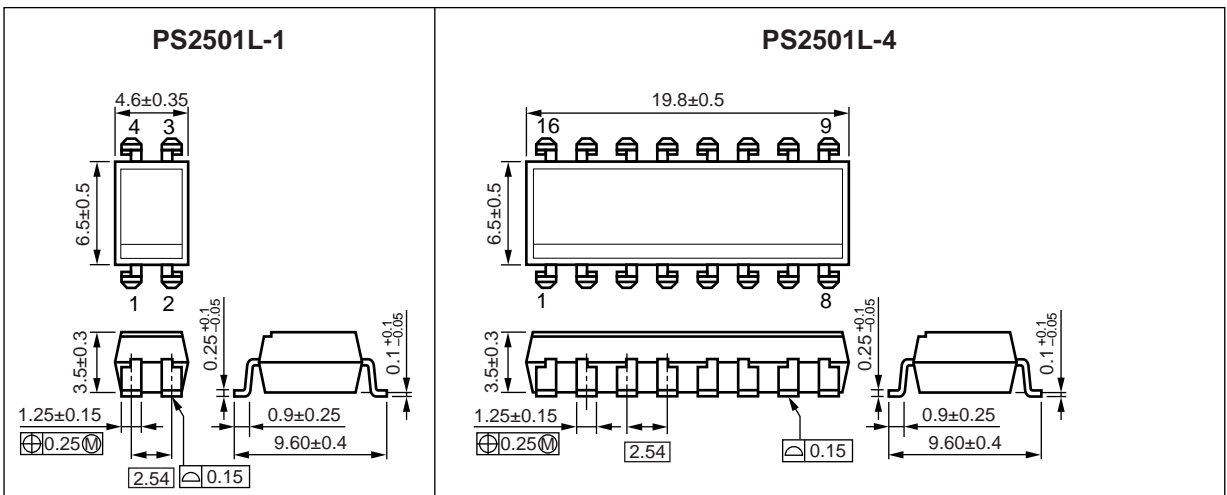

PHOTOCOUPLER CONSTRUCTION

| Parameter | Unit (MIN.) |
|-------------------------|-------------|
| Air Distance | 7 mm |
| Outer Creepage Distance | 7 mm |
| Inner Creepage Distance | 3.5 mm |
| Isolation Distance | 0.3 mm |

★ MARKING EXAMPLE

PS2501-1

M J 0 31
 CTR Rank Code In-house Code Year Assembled (Last 1 Digit) Week Assembled

| | Package | Made in Japan | Made in Taiwan |
|-----------------------------|---------|---------------|----------------|
| Pb-Free | New PKG | J | K |
| Pb-Free and Halogen Free *1 | New PKG | R | Y |

*1 Special version

PS2501-4

N J 0 31
 CTR Rank Code In-house Code Year Assembled (Last 1 Digit) Week Assembled

| Package | Made in Japan |
|---------|---------------|
| New PKG | J |

★ **ORDERING INFORMATION**

| Part Number | Order Number | Solder Plating Specification | Packing Style | Safety Standard Approval | Application Part Number ^{*1} |
|--------------|-----------------|------------------------------|------------------------------|------------------------------------|---------------------------------------|
| PS2501-1 | PS2501-1-A | Pb-Free | Magazine case 100 pcs | Standard products (UL approved) | PS2501-1 |
| PS2501L-1 | PS2501L-1-A | | Embossed Tape 2 000 pcs/reel | | |
| PS2501L-1-F3 | PS2501L-1-F3-A | | | | |
| PS2501-4 | PS2501-4-A | | Magazine case 20 pcs | | PS2501-4 |
| PS2501L-4 | PS2501L-4-A | | | | |
| PS2501-1 | PS2501-1Y-A | Special version | Magazine case 100 pcs | Standard products (UL approved) | PS2501-1 |
| PS2501L-1 | PS2501L-1Y-A | (Pb-Free and | Embossed Tape 2 000 pcs/reel | | |
| PS2501L-1-F3 | PS2501L-1Y-F3-A | Halogen Free) | | | |

*1 For the application of the Safety Standard, following part number should be used.

ABSOLUTE MAXIMUM RATINGS (Unless otherwise specified, T_A = 25°C)

| Parameter | | Symbol | Ratings | | Unit |
|---------------------------------|------------------------------------|---------------------|------------------------|------------------------|---------|
| | | | PS2501-1, PS2501L-1 | PS2501-4, PS2501L-4 | |
| Diode | Reverse Voltage | V _R | 6 | | V |
| | Forward Current (DC) | I _F | 80 | | mA/ch |
| | Power Dissipation Derating | ΔP _D /°C | 1.5 | 1.2 | mW/°C |
| | Power Dissipation | P _D | 150 | 120 | mW/ch |
| | Peak Forward Current ^{*1} | I _{FP} | 1 | | A/ch |
| Transistor | Collector to Emitter Voltage | V _{CEO} | 80 | | V |
| | Emitter to Collector Voltage | V _{ECO} | 7 | | V |
| | Collector Current | I _C | 50 | | mA/ch |
| | Power Dissipation Derating | ΔP _C /°C | 1.5 | 1.2 | mW/°C |
| | Power Dissipation | P _C | 150 | 120 | mW/ch |
| Isolation Voltage ^{*2} | | BV | 5 000 | | Vr.m.s. |
| Operating Ambient Temperature | | T _A | -55 to +100 | | °C |
| Storage Temperature | | T _{stg} | -55 to +150 | | °C |

*1 PW = 100 μs, Duty Cycle = 1%

*2 AC voltage for 1 minute at T_A = 25°C, RH = 60% between input and output.

Pins 1-2 shorted together, 3-4 shorted together (PS2501-1, PS2501L-1).

Pins 1-8 shorted together, 9-16 shorted together (PS2501-4, PS2501L-4).

ELECTRICAL CHARACTERISTICS (T_A = 25°C)

| Parameter | | Symbol | Conditions | MIN. | TYP. | MAX. | Unit |
|------------|--|----------------------|---|------------------|------|------|------|
| Diode | Forward Voltage | V _F | I _F = 10 mA | | 1.17 | 1.4 | V |
| | Reverse Current | I _R | V _R = 5 V | | | 5 | μA |
| | Terminal Capacitance | C _t | V = 0 V, f = 1.0 MHz | | 50 | | pF |
| Transistor | Collector to Emitter Dark Current | I _{CEO} | V _{CE} = 80 V, I _F = 0 mA | | | 100 | nA |
| Coupled | Current Transfer Ratio (I _c /I _F) ^{*1} | CTR | I _F = 5 mA, V _{CE} = 5 V | 80 | 300 | 600 | % |
| | Collector Saturation Voltage | V _{CE(sat)} | I _F = 10 mA, I _c = 2 mA | | | 0.3 | V |
| | Isolation Resistance | R _{I-O} | V _{I-O} = 1.0 kV _{DC} | 10 ¹¹ | | | Ω |
| | Isolation Capacitance | C _{I-O} | V = 0 V, f = 1.0 MHz | | 0.5 | | pF |
| | Rise Time ^{*2} | t _r | V _{CC} = 10 V, I _c = 2 mA, R _L = 100 Ω | | 3 | | μs |
| | Fall Time ^{*2} | t _f | | | 5 | | |

*1 CTR rank (* : only PS2501-1, PS2501L-1)

- K* : 300 to 600 (%)
- L* : 200 to 400 (%)
- M* : 80 to 240 (%)
- D* : 100 to 300 (%)
- H* : 80 to 160 (%)
- W* : 130 to 260 (%)
- Q* : 100 to 200 (%)
- N : 80 to 600 (%)

<R>

*2 Test circuit for switching time

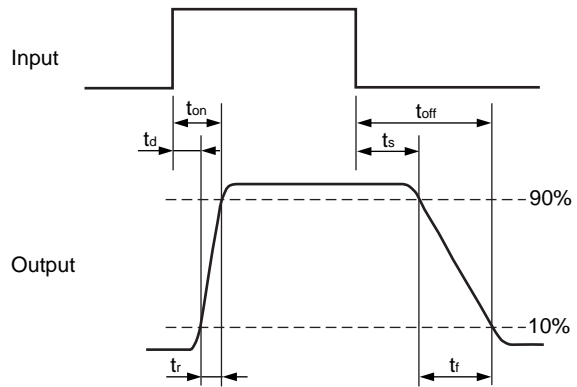
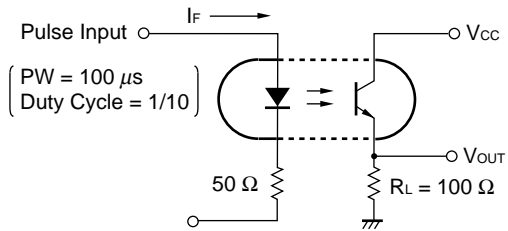

TYPICAL CHARACTERISTICS (Unless otherwise specified, $T_A = 25^\circ\text{C}$)

DIODE POWER DISSIPATION vs. AMBIENT TEMPERATURE

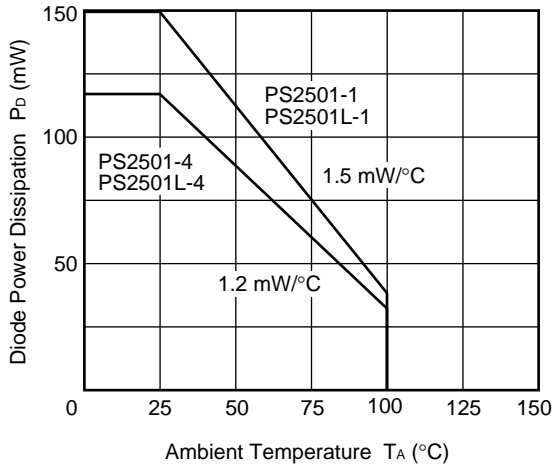

TRANSISTOR POWER DISSIPATION vs. AMBIENT TEMPERATURE

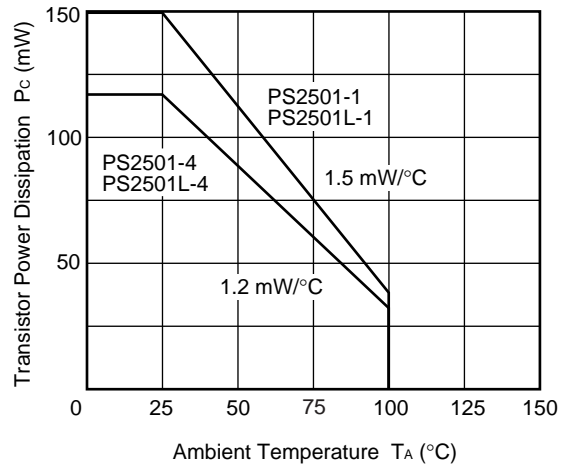

FORWARD CURRENT vs. FORWARD VOLTAGE

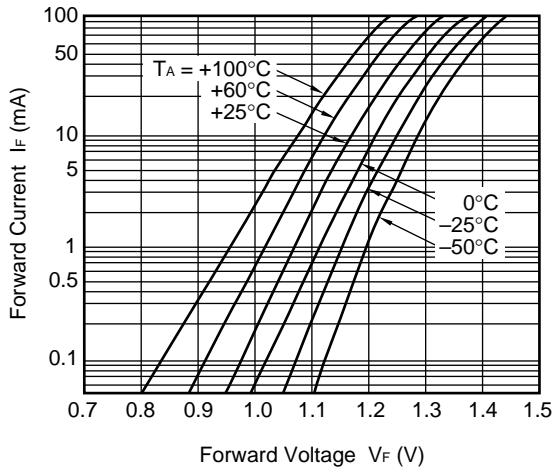

COLLECTOR CURRENT vs. COLLECTOR TO EMITTER VOLTAGE

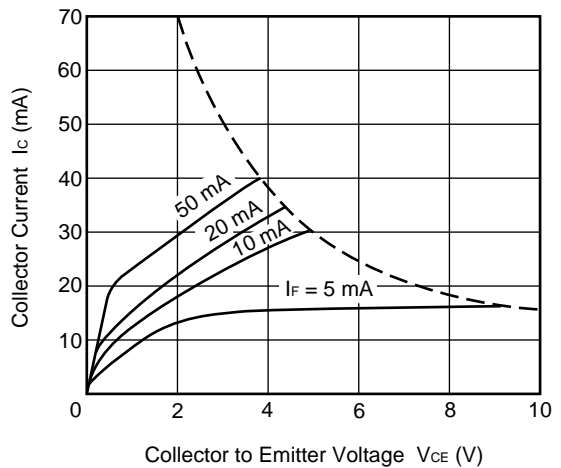

COLLECTOR TO EMITTER DARK CURRENT vs. AMBIENT TEMPERATURE

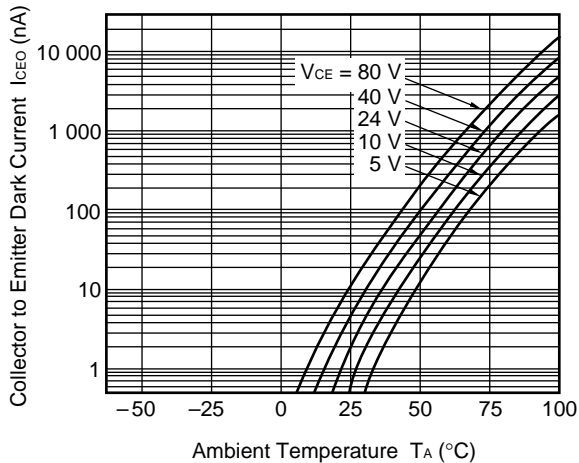

COLLECTOR CURRENT vs. COLLECTOR SATURATION VOLTAGE

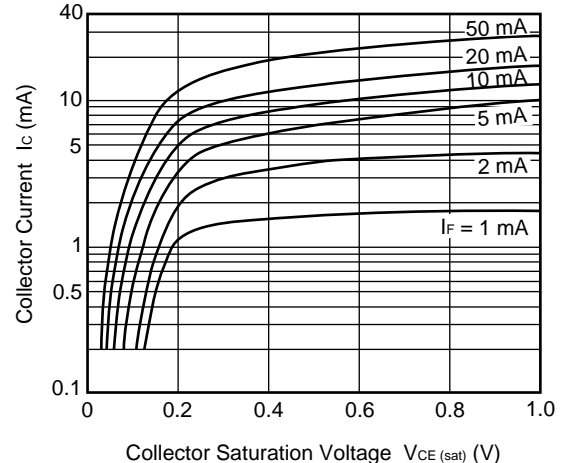

Remark The graphs indicate nominal characteristics.

NORMALIZED CURRENT TRANSFER RATIO vs. AMBIENT TEMPERATURE

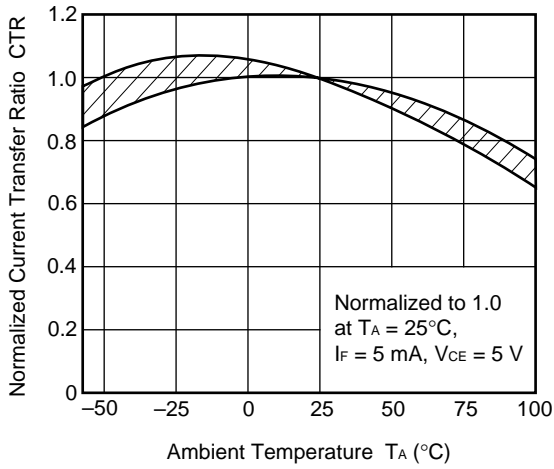

CURRENT TRANSFER RATIO vs. FORWARD CURRENT

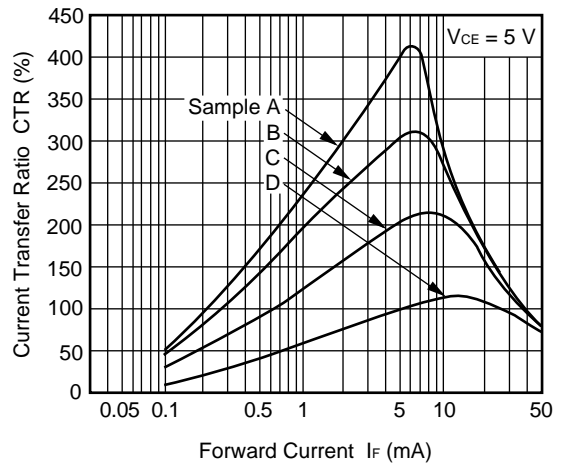

SWITCHING TIME vs. LOAD RESISTANCE

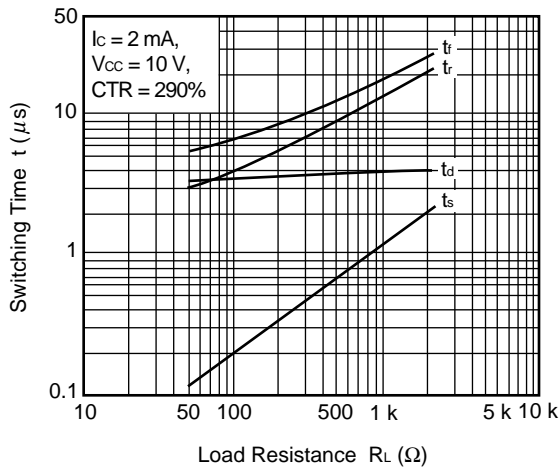

SWITCHING TIME vs. LOAD RESISTANCE

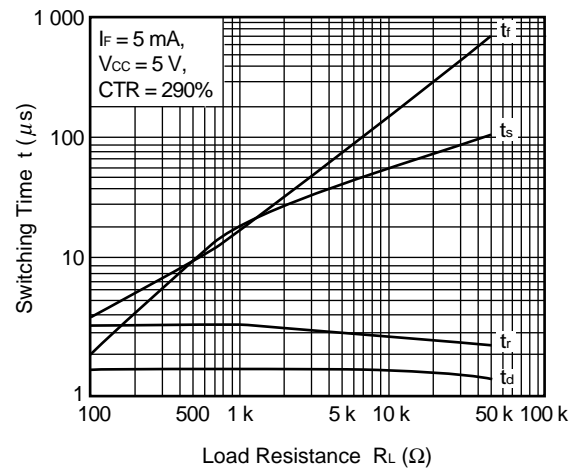

FREQUENCY RESPONSE

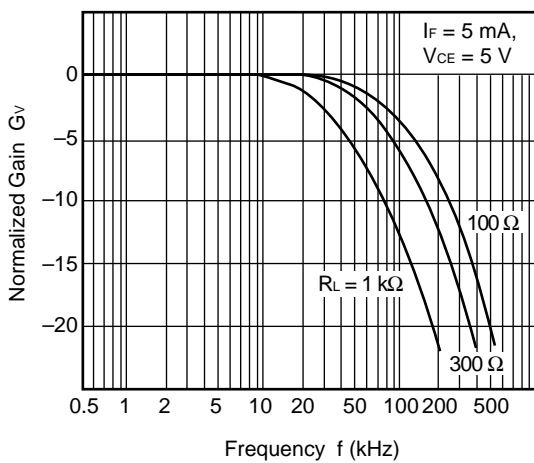

LONG TERM CTR DEGRADATION

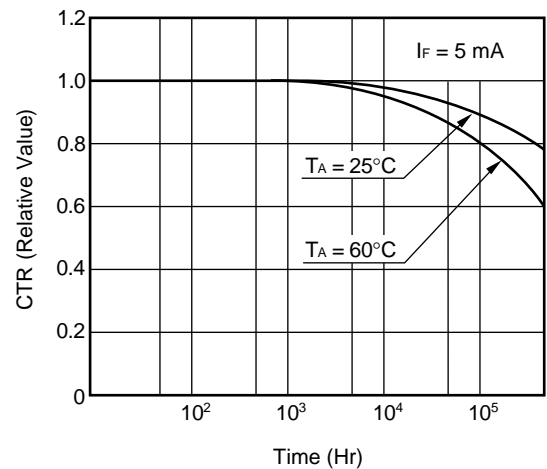

Remark The graphs indicate nominal characteristics.

TAPING SPECIFICATIONS (UNIT : mm)

Outline and Dimensions (Tape)

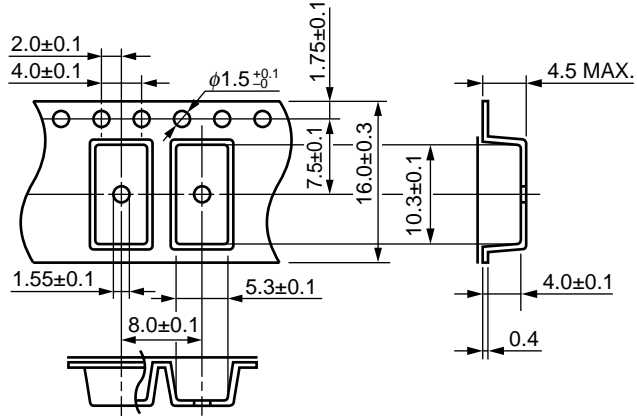

Tape Direction

PS2501L-1-F3

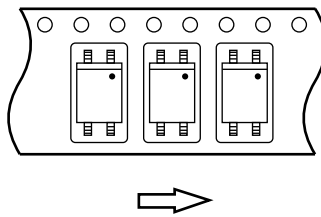

Outline and Dimensions (Reel)

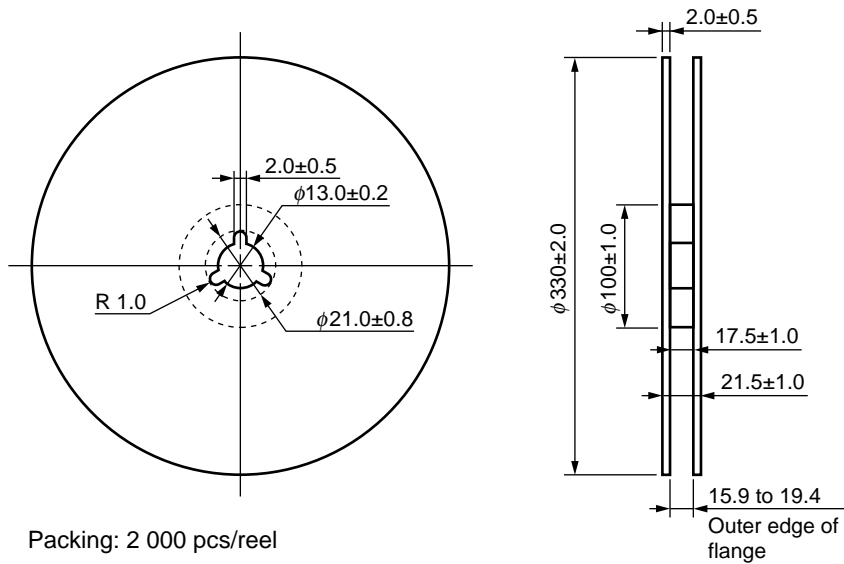

NOTES ON HANDLING

1. Recommended soldering conditions

(1) Infrared reflow soldering

- Peak reflow temperature 260°C or below (package surface temperature)
- Time of peak reflow temperature 10 seconds or less
- Time of temperature higher than 220°C 60 seconds or less
- Time to preheat temperature from 120 to 180°C 120±30 s
- Number of reflows Three
- Flux Rosin flux containing small amount of chlorine (The flux with a maximum chlorine content of 0.2 Wt% is recommended.)

Recommended Temperature Profile of Infrared Reflow

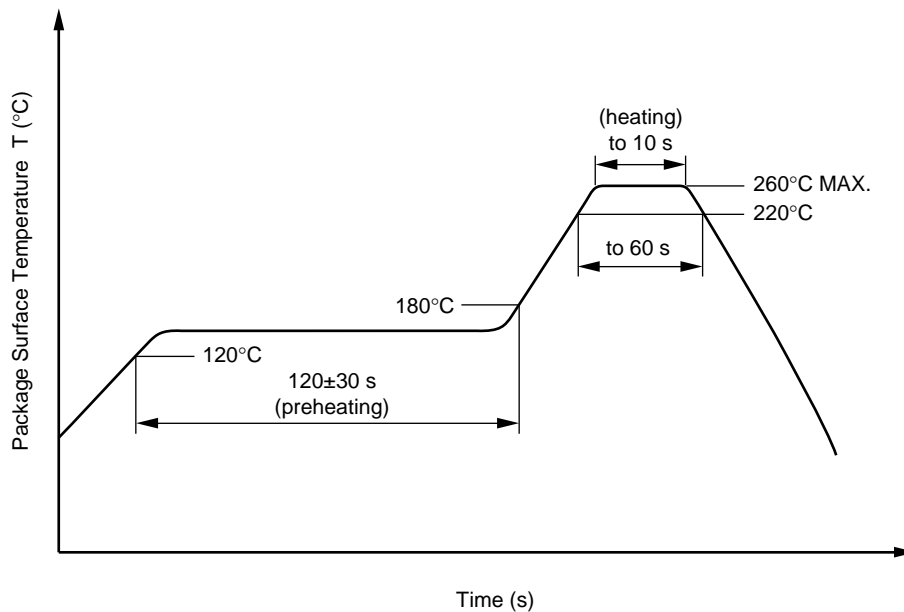

(2) Wave soldering

- Temperature 260°C or below (molten solder temperature)
- Time 10 seconds or less
- Preheating conditions 120°C or below (package surface temperature)
- Number of times One (Allowed to be dipped in solder including plastic mold portion.)
- Flux Rosin flux containing small amount of chlorine (The flux with a maximum chlorine content of 0.2 Wt% is recommended.)

(3) Soldering by soldering iron

- Peak temperature (lead part temperature) 350°C or below
- Time (each pins) 3 seconds or less
- Flux Rosin flux containing small amount of chlorine (The flux with a maximum chlorine content of 0.2 Wt% is recommended.)

- (a) Soldering of leads should be made at the point 1.5 to 2.0 mm from the root of the lead.
- (b) Please be sure that the temperature of the package would not be heated over 100°C.

(4) Cautions

- Fluxes

Avoid removing the residual flux with freon-based and chlorine-based cleaning solvent.

2. Cautions regarding noise

Be aware that when voltage is applied suddenly between the photocoupler's input and output or between collector-emitters at startup, the output transistor may enter the on state, even if the voltage is within the absolute maximum ratings.

3. Measurement conditions of current transfer ratios (CTR), which differ according to photocoupler

Check the setting values before use, since the forward current conditions at CTR measurement differ according to product.

When using products other than at the specified forward current, the characteristics curves may differ from the standard curves due to CTR value variations or the like. This tendency may sometimes be obvious, especially below $I_F = 1$ mA.

Therefore, check the characteristics under the actual operating conditions and thoroughly take variations or the like into consideration before use.

USAGE CAUTIONS

1. Protect against static electricity when handling.
2. Avoid storage at a high temperature and high humidity.

| | | |
|-----------------------|----------------------|---|
| <p>Caution</p> | <p>GaAs Products</p> | <p>This product uses gallium arsenide (GaAs). GaAs vapor and powder are hazardous to human health if inhaled or ingested, so please observe the following points.</p> <ul style="list-style-type: none"> • Follow related laws and ordinances when disposing of the product. If there are no applicable laws and/or ordinances, dispose of the product as recommended below. <ol style="list-style-type: none"> 1. Commission a disposal company able to (with a license to) collect, transport and dispose of materials that contain arsenic and other such industrial waste materials. 2. Exclude the product from general industrial waste and household garbage, and ensure that the product is controlled (as industrial waste subject to special control) up until final disposal. • Do not burn, destroy, cut, crush, or chemically dissolve the product. • Do not lick the product or in any way allow it to enter the mouth. |
|-----------------------|----------------------|---|

NOTICE

1. Descriptions of circuits, software and other related information in this document are provided only to illustrate the operation of semiconductor products and application examples. You are fully responsible for the incorporation of these circuits, software, and information in the design of your equipment. California Eastern Laboratories and Renesas Electronics assumes no responsibility for any losses incurred by you or third parties arising from the use of these circuits, software, or information.
2. California Eastern Laboratories has used reasonable care in preparing the information included in this document, but California Eastern Laboratories does not warrant that such information is error free. California Eastern Laboratories and Renesas Electronics assumes no liability whatsoever for any damages incurred by you resulting from errors in or omissions from the information included herein.
3. California Eastern Laboratories and Renesas Electronics do not assume any liability for infringement of patents, copyrights, or other intellectual property rights of third parties by or arising from the use of Renesas Electronics products or technical information described in this document. No license, express, implied or otherwise, is granted hereby under any patents, copyrights or other intellectual property rights of California Eastern Laboratories or Renesas Electronics or others.
4. You should not alter, modify, copy, or otherwise misappropriate any Renesas Electronics product, whether in whole or in part. California Eastern Laboratories and Renesas Electronics assume no responsibility for any losses incurred by you or third parties arising from such alteration, modification, copy or otherwise misappropriation of Renesas Electronics product.
5. Renesas Electronics products are classified according to the following two quality grades: "Standard" and "High Quality". The recommended applications for each Renesas Electronics product depends on the product's quality grade, as indicated below. "Standard": Computers; office equipment; communications equipment; test and measurement equipment; audio and visual equipment; home electronic appliances; machine tools; personal electronic equipment; and industrial robots etc. "High Quality": Transportation equipment (automobiles, trains, ships, etc.); traffic control systems; anti-disaster systems; anti-crime systems; and safety equipment etc. Renesas Electronics products are neither intended nor authorized for use in products or systems that may pose a direct threat to human life or bodily injury (artificial life support devices or systems, surgical implantations etc.), or may cause serious property damages (nuclear reactor control systems, military equipment etc.). You must check the quality grade of each Renesas Electronics product before using it in a particular application. You may not use any Renesas Electronics product for any application for which it is not intended. California Eastern Laboratories and Renesas Electronics shall not be in any way liable for any damages or losses incurred by you or third parties arising from the use of any Renesas Electronics product for which the product is not intended by California Eastern Laboratories or Renesas Electronics.
6. You should use the Renesas Electronics products described in this document within the range specified by California Eastern Laboratories, especially with respect to the maximum rating, operating supply voltage range, movement power voltage range, heat radiation characteristics, installation and other product characteristics. California Eastern Laboratories shall have no liability for malfunctions or damages arising out of the use of Renesas Electronics products beyond such specified ranges.
7. Although Renesas Electronics endeavors to improve the quality and reliability of its products, semiconductor products have specific characteristics such as the occurrence of failure at a certain rate and malfunctions under certain use conditions. Further, Renesas Electronics products are not subject to radiation resistance design. Please be sure to implement safety measures to guard them against the possibility of physical injury, and injury or damage caused by fire in the event of the failure of a Renesas Electronics product, such as safety design for hardware and software including but not limited to redundancy, fire control and malfunction prevention, appropriate treatment for aging degradation or any other appropriate measures. Because the evaluation of microcomputer software alone is very difficult, please evaluate the safety of the final products or systems manufactured by you.
8. Please contact a California Eastern Laboratories sales office for details as to environmental matters such as the environmental compatibility of each Renesas Electronics product. Please use Renesas Electronics products in compliance with all applicable laws and regulations that regulate the inclusion or use of controlled substances, including without limitation, the EU RoHS Directive. California Eastern Laboratories and Renesas Electronics assume no liability for damages or losses occurring as a result of your noncompliance with applicable laws and regulations.
9. Renesas Electronics products and technology may not be used for or incorporated into any products or systems whose manufacture, use, or sale is prohibited under any applicable domestic or foreign laws or regulations. You should not use Renesas Electronics products or technology described in this document for any purpose relating to military applications or use by the military, including but not limited to the development of weapons of mass destruction. When exporting the Renesas Electronics products or technology described in this document, you should comply with the applicable export control laws and regulations and follow the procedures required by such laws and regulations.
10. It is the responsibility of the buyer or distributor of California Eastern Laboratories, who distributes, disposes of, or otherwise places the Renesas Electronics product with a third party, to notify such third party in advance of the contents and conditions set forth in this document, California Eastern Laboratories and Renesas Electronics assume no responsibility for any losses incurred by you or third parties as a result of unauthorized use of Renesas Electronics products.
11. This document may not be reproduced or duplicated in any form, in whole or in part, without prior written consent of California Eastern Laboratories.
12. Please contact a California Eastern Laboratories sales office if you have any questions regarding the information contained in this document or Renesas Electronics products, or if you have any other inquiries.

NOTE 1: "Renesas Electronics" as used in this document means Renesas Electronics Corporation and also includes its majority-owned subsidiaries.

NOTE 2: "Renesas Electronics product(s)" means any product developed or manufactured by or for Renesas Electronics.



NOTE 3: Products and product information are subject to change without notice.

CEL Headquarters • 4590 Patrick Henry Drive, Santa Clara, CA 95054 • Phone (408) 919-2500 • www.cel.com

For a complete list of sales offices, representatives and distributors,
Please visit our website: www.cel.com/contactus

Looking for pricing, stock, or lifecycle information?

Click below to explore more details on WIN SOURCE:

-  [View PS2501L-1-A on WIN SOURCE](#)
-  [CEL Information](#)

Optimize Your Supply Chain with WIN SOURCE Solutions

-  Global Sourcing Solution
-  Obsolete Management
-  Cost Control Management
-  Shortage Management
-  Alternative Solution
-  Excess Inventory Management