



**THE DATASHEET OF
PMP5818UWSR**



PMP 5000 series PoL Regulators
 Input 4.5 - 14 V, Output up to 16 A / 88 W

1/ 28701- BMR 657 Rev. A November 2017
 © Flex

Key Features

- Industry standard POLA™ compatible
- 22.1 x 18.93 x 8.5 mm (0.87 x 0.745 x 0.335 in.)
- High efficiency, up to. 96%
- Auto Track™ sequencing pin
- Turbo Trans™ Technology for Ultra-Fast Transient
- Smart Sync Technology
- More than 6.0 million hours MTBF

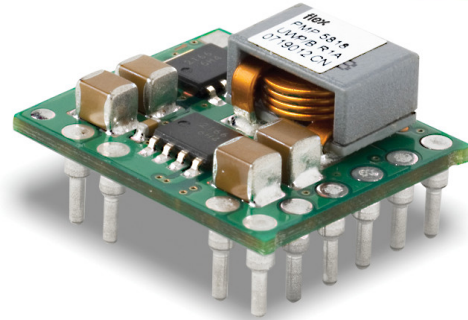

General Characteristics

- Operating temperature: -40°C to 85°C
- Input under voltage protection
- Start up into a pre-biased output
- Output short-circuit protection
- On/Off inhibit control
- Wide input voltage function
- Wide output voltage adjust function
- Highly automated manufacturing ensures quality
- ISO 9001/14001 certified supplier

Safety Approvals



Design for Environment



Meets requirements in high-temperature lead-free soldering processes.

Contents

General Information	2
Safety Specification	3
Absolute Maximum Ratings	4
Product Program	Ordering No.
0.7-5.5V, 16A / 88W	PMP 5818UWP
0.7V, 16A / 11.2W Electrical Specification	5
1.0V, 16A / 16.0W Electrical Specification	9
1.2V, 16A / 19.2W Electrical Specification	13
1.5V, 16A / 24.0W Electrical Specification	18
1.8V, 16A / 28.8W Electrical Specification	23
2.5V, 16A / 40.0W Electrical Specification	28
3.3V, 16A / 52.8W Electrical Specification	33
5.0V, 16A / 80.0W Electrical Specification	36
EMC Specification	42
Operating Information	42
Thermal Consideration	48
Connections	49
Mechanical Information	51
Soldering Information	53
Delivery Information	53
Product Qualification Specification	56

PMP 5000 series PoL Regulators

Input 4.5 - 14 V, Output up to 16 A / 88 W

1/ 28701- BMR 657 Rev. A November 2017

© Flex

General Information

Ordering Information

See Contents for individual product ordering numbers.

Option	Suffix	Ordering No.
Through hole pin	P	PMP 5818UW P
SMD pin with lead-free surface	SR	PMP 5818UW SR

Reliability

The Mean Time Between Failure (MTBF) is calculated at full output power and an operating ambient temperature (T_A) of +40°C, which is a typical condition in Information and Communication Technology (ICT) equipment. Different methods could be used to calculate the predicted MTBF and failure rate which may give different results. Flex currently uses Telcordia SR332.

Predicted MTBF for the series is:

- 6.0 million hours according to Telcordia SR332, issue 1, Black box technique.

Telcordia SR332 is a commonly used standard method intended for reliability calculations in ICT equipment. The parts count procedure used in this method was originally modelled on the methods from MIL-HDBK-217F, Reliability Predictions of Electronic Equipment. It assumes that no reliability data is available on the actual units and devices for which the predictions are to be made, i.e. all predictions are based on generic reliability parameters.

Compatibility with RoHS requirements

The products are compatible with the relevant clauses and requirements of the RoHS directive 2011/65/EU and have a maximum concentration value of 0.1% by weight in homogeneous materials for lead, mercury, hexavalent chromium, PBB and PBDE and of 0.01% by weight in homogeneous materials for cadmium.

Exemptions in the RoHS directive utilized in Flex products are found in the Statement of Compliance document.

Flex fulfills and will continuously fulfill all its obligations under regulation (EC) No 1907/2006 concerning the registration, evaluation, authorization, and restriction of chemicals (REACH) as they enter into force and is through product materials declarations preparing for the obligations to communicate information on substances in the products.

Quality Statement

The products are designed and manufactured in an industrial environment where quality systems and methods like ISO 9000, Six Sigma, and SPC are intensively in use to boost the continuous improvements strategy. Infant

mortality or early failures in the products are screened out and they are subjected to an ATE-based final test. Conservative design rules, design reviews and product qualifications, plus the high competence of an engaged work force, contribute to the high quality of the products.

Warranty

Warranty period and conditions are defined in Flex General Terms and Conditions of Sale.

Limitation of Liability

Flex does not make any other warranties, expressed or implied including any warranty of merchantability or fitness for a particular purpose (including, but not limited to, use in life support applications, where malfunctions of product can cause injury to a person's health or life).

© Flex 2017

The information and specifications in this technical specification is believed to be correct at the time of publication. However, no liability is accepted for inaccuracies, printing errors or for any consequences thereof. Flex reserves the right to change the contents of this technical specification at any time without prior notice.

PMP 5000 series PoL Regulators
Input 4.5 - 14 V, Output up to 16 A / 88 W

1/ 28701- BMR 657 Rev. A November 2017

© Flex

Safety Specification

General information

Flex DC/DC converters and DC/DC regulators are designed in accordance with the safety standards IEC 60950-1, EN 60950-1 and UL 60950-1 *Safety of Information Technology Equipment*.

IEC/EN/UL 60950-1 contains requirements to prevent injury or damage due to the following hazards:

- Electrical shock
- Energy hazards
- Fire
- Mechanical and heat hazards
- Radiation hazards
- Chemical hazards

On-board DC/DC converters and DC/DC regulators are defined as component power supplies. As components, they cannot fully comply with the provisions of any safety requirements without “conditions of acceptability”.

Clearance between conductors and between conductive parts of the component power supply and conductors on the board in the final product must meet the applicable safety requirements. Certain conditions of acceptability apply for component power supplies with limited stand-off (see Mechanical Information and Safety Certificate for further information). It is the responsibility of the installer to ensure that the final product housing these components complies with the requirements of all applicable safety standards and regulations for the final product.

Component power supplies for general use should comply with the requirements in IEC/EN/UL 60950-1 *Safety of Information Technology Equipment*. Product related standards, e.g. IEEE 802.3af *Power over Ethernet*, and ETS-300132-2 *Power interface at the input to telecom equipment, operated by direct current (dc)* are based on IEC/EN/UL 60950-1 with regards to safety.

Flex DC/DC converters, Power interface modules and DC/DC regulators are UL 60950-1 recognized and certified in accordance with EN 60950-1. The flammability rating for all construction parts of the products meet requirements for V-0 class material according to IEC 60695-11-10, *Fire hazard testing, test flames – 50 W horizontal and vertical flame test methods*.

Non-isolated DC/DC regulators

The input voltage to the DC/DC regulator is SELV (Safety Extra Low Voltage) and the output remains SELV under normal and abnormal operating conditions.

PMP 5000 series PoL Regulators
 Input 4.5 - 14 V, Output up to 16 A / 88 W

1/ 28701- BMR 657 Rev. A November 2017
 © Flex

Absolute Maximum Ratings

Characteristics		min	typ	max	Unit
T_{ref}	Operating Temperature (see Thermal Consideration section)	-40		85	°C
T_S	Storage temperature	-40		125	°C
V_I	Input voltage	4.5	5/12	14	V
V_{RC}	Remote Control pin voltage (see Operating Information section)	Positive logic option		Open	V
		Negative logic option	N/A	N/A	V
V_{Adj}	Adjust pin voltage (see Operating Information section)	N/A		N/A	V

Stress in excess of Absolute Maximum Ratings may cause permanent damage. Absolute Maximum Ratings, sometimes referred to as no destruction limits, are normally tested with one parameter at a time exceeding the limits of Output data or Electrical Characteristics. If exposed to stress above these limits, function and performance may degrade in an unspecified manner.

Fundamental Circuit Diagram

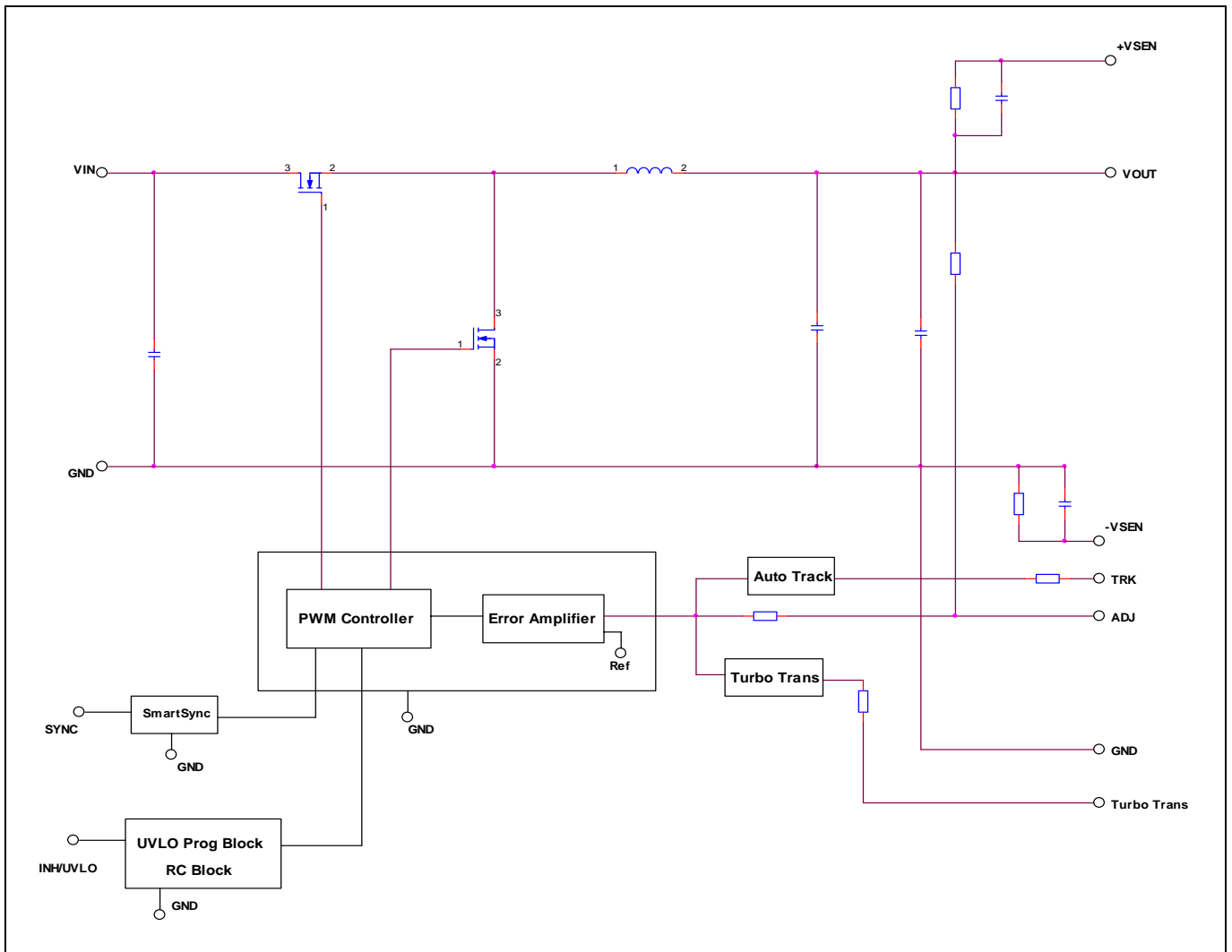

PMP 5000 series PoL Regulators
 Input 4.5 - 14 V, Output up to 16 A / 88 W

1/ 28701- BMR 657 Rev. A November 2017

© Flex

0.7V, 16A / 11.2W Electrical Specification
PMP 5818UW P
 $T_{ref} = -40$ to $+85^{\circ}\text{C}$, $V_I = 4.5$ to 7.7 V, $R_{adj} = 681$ k Ω , unless otherwise specified under Conditions.

 Typical values given at: $T_{ref} = +25^{\circ}\text{C}$, $V_I = 5$ V, max I_O , unless otherwise specified under Conditions.

 Additional $C_{in} = 330+22$ μF and $C_{out} = 220$ μF . See Operating Information section for selection of capacitor types.

Connect the sense pin, where available, to the output pin.

Characteristics		Conditions	min	typ	max	Unit
V_I	Input voltage range		4.5	5	7.7	V
V_{loff}	Turn-off input voltage	Decreasing input voltage	3.9	4.1		V
V_{lon}	Turn-on input voltage	Increasing input voltage		4.2	4.4	V
C_I	Internal input capacitance			44		μF
P_O	Output power		0		11.2	W
η	Efficiency	50 % of max I_O		86.0		%
		max I_O		79.9		
P_d	Power Dissipation	max I_O		2.8	3.3	W
P_{li}	Input idling power	$I_O = 0$ A, $V_I = 5$ V		0.17		W
P_{RC}	Input standby power	$V_I = 5$ V (turned off with RC)		4.7		mW
I_S	Static Input current	$V_I = 5$ V, max I_O		2.82		A
f_s	Switching frequency	0-100 % of max I_O	270	300	330	kHz

V_{oi}	Output voltage initial setting and accuracy	$T_{ref} = +25^{\circ}\text{C}$, $V_I = 5$ V, max I_O	0.689	0.700	0.711	V
V_O	Output voltage tolerance band	10-100 % of max I_O	0.679		0.721	V
	Idling voltage	$I_O = 0$ A		0.700		V
	Line regulation	max I_O		± 3		mV
	Load regulation	$V_I = 5$ V, 0-100 % of max I_O		± 2		mV
V_{tr}	Load transient voltage deviation	$V_I = 5$ V, Load step 25-75-25 % of max I_O , $di/dt = 2.5$ A/ μs		± 75		mV
t_{tr}	Load transient recovery time	Without Turbo Trans $C_o = 1640$ μF Type C		40		μs
V_{tr}	Load transient voltage deviation	$V_I = 5$ V, Load step 25-75-25 % of max I_O , $di/dt = 2.5$ A/ μs		± 40		mV
t_{tr}	Load transient recovery time	With Turbo Trans $C_o = 1640$ μF Type C; $R_{TT} = 2$ k Ω		30		μs
t_r	Ramp-up time (from 10–90 % of V_{oi})	100 % of max I_O		2.4		ms
t_s	Start-up time (from V_I connection to 90 % of V_{oi})			7.1		ms
t_f	V_I shut-down fall time. (From V_I off to 10 % of V_O)	Max I_O		1.1		ms
		$I_O = 0.1$ A		9.0		ms
t_{RC} t_{inh}	RC start-up time	Max I_O		7.0		ms
	RC shut-down fall time (From RC off to 10 % of V_O)	Max I_O		0.3		ms
		$I_O = 0.1$ A		9.0		ms
I_O	Output current		0		16	A

PMP 5000 series PoL Regulators
Input 4.5 - 14 V, Output up to 16 A / 88 W

1/ 28701- BMR 657 Rev. A November 2017

© Flex

I_{lim}	Current limit threshold	$T_{ref} < \max T_{ref}$	29	A
I_{sc}	Short circuit current	$T_{ref} = 25^{\circ}\text{C}$	29	A
V_{Oac}	Output ripple & noise	See ripple & noise section, $\max I_O$	6.1	mVp-p

PMP 5000 series PoL Regulators
 Input 4.5 - 14 V, Output up to 16 A / 88 W

1/ 28701- BMR 657 Rev. A November 2017
 © Flex

0.7V, 16A / 11.2W Typical Characteristics

PMP 5818UW P

Efficiency

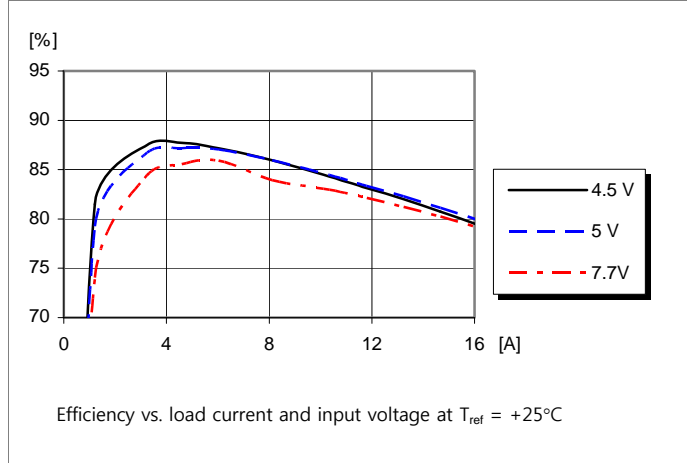

Power Dissipation

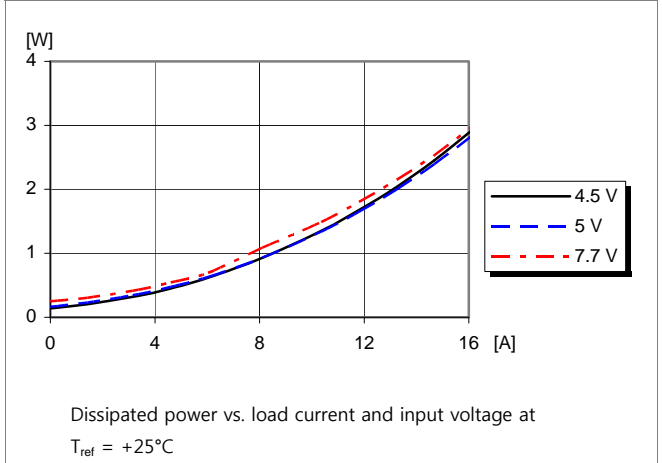

Output Current Derating

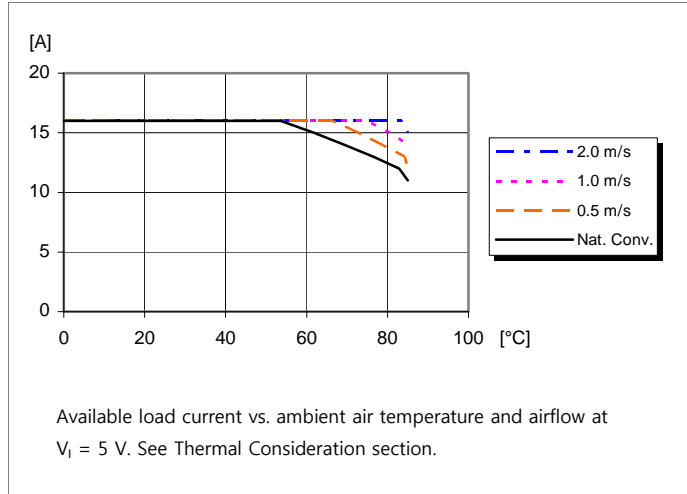

Thermal Resistance

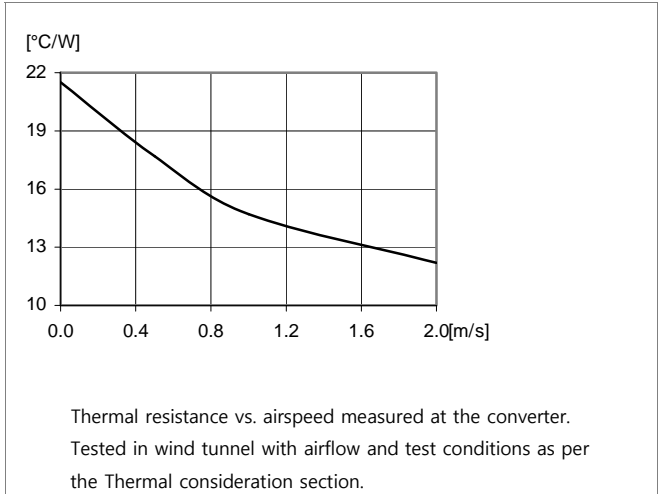

Output Characteristics

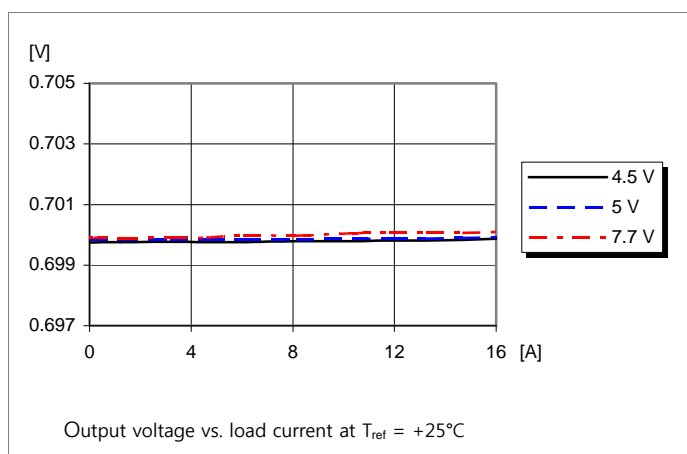

Current Limit Characteristics

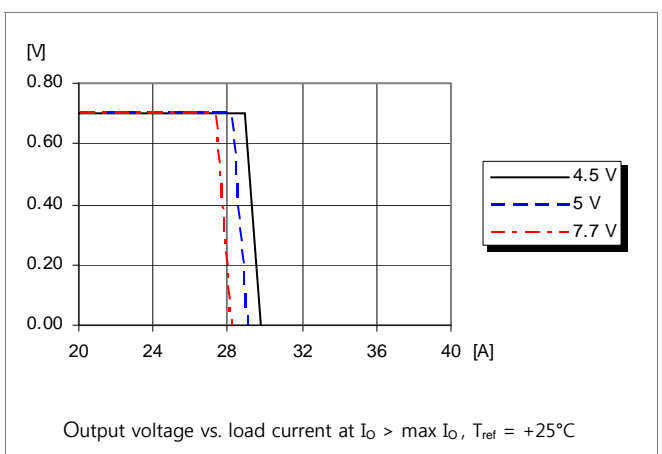

PMP 5000 series PoL Regulators
 Input 4.5 - 14 V, Output up to 16 A / 88 W

1/ 28701- BMR 657 Rev. A November 2017

© Flex

0.7V, 16A / 11.2W Typical Characteristics

PMP 5818UW P

Start-up

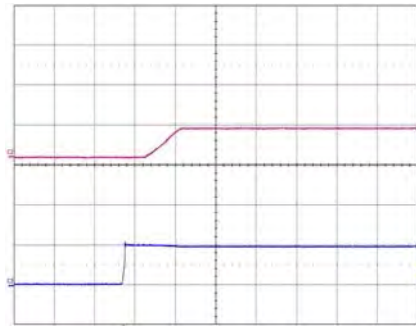

Start-up enabled by connecting V_I at: $T_{ref} = +25^\circ\text{C}$, $V_I = 5\text{ V}$,
 Top trace: output voltage (1 V/div).
 Bottom trace: input voltage (5 V/div).

Shut-down

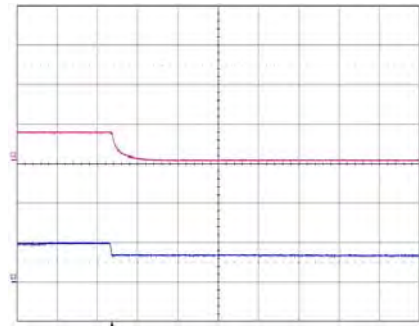

Shut-down enabled by disconnecting V_I at: $T_{ref} = +25^\circ\text{C}$, $V_I = 5\text{ V}$,
 Top trace: output voltage (1.0 V/div).
 Bottom trace: input voltage (5 V/div).

Output Ripple & Noise

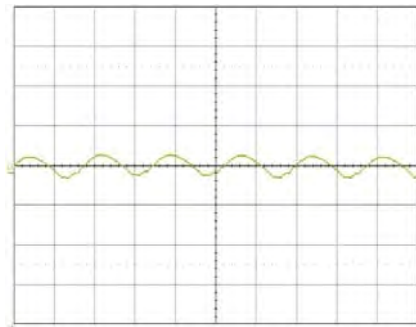

Output voltage ripple at: $T_{ref} = +25^\circ\text{C}$, $V_I = 5\text{ V}$,
 $I_O = 16\text{ A}$ resistive load.
 Trace: output voltage (10 mV/div).
 Time scale: (2 μs /div).

Output Load Transient Response

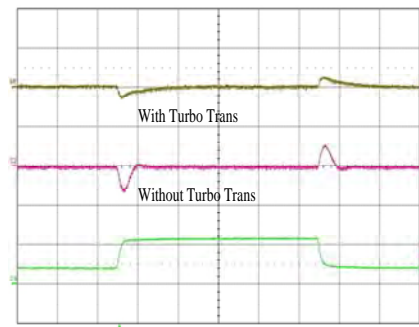

Output voltage response to load current step-change (4-12-4 A) at: $T_{ref} = +25^\circ\text{C}$, $V_I = 5\text{ V}$.
 Top trace: output voltage (100 mV/div).
 Middle trace: output voltage (100 mV/div).
 Bottom trace: load current (10 A/div).

Output Voltage Adjust (see operating information)

Passive adjust

The resistor value for an adjusted output voltage is calculated by using the equations in the operating information.

$$R_{SET} = 10k\Omega \times \frac{0.69}{V_o - 0.69} - 1.43k\Omega$$

PMP 5000 series PoL Regulators
 Input 4.5 - 14 V, Output up to 16 A / 88 W

1/ 28701- BMR 657 Rev. A November 2017

© Flex

1.0V, 16A / 16.0W Electrical Specification
PMP 5818UW P
 $T_{ref} = -40$ to $+85^{\circ}\text{C}$, $V_I = 4.5$ to 11 V, $R_{adj} = 20.8$ k Ω , unless otherwise specified under Conditions.

 Typical values given at: $T_{ref} = +25^{\circ}\text{C}$, $V_I = 5$ V, max I_O , unless otherwise specified under Conditions.

 Additional $C_{in} = 330+22$ μF and $C_{out} = 220$ μF . See Operating Information section for selection of capacitor types.

Connect the sense pin, where available, to the output pin.

Characteristics		Conditions	min	typ	max	Unit
V_I	Input voltage range		4.5	5	11	V
V_{loff}	Turn-off input voltage	Decreasing input voltage	3.9	4.1		V
V_{lon}	Turn-on input voltage	Increasing input voltage		4.2	4.4	V
C_I	Internal input capacitance			44		μF
P_O	Output power		0		16	W
η	Efficiency	50 % of max I_O		89.0		%
		max I_O		84.3		
P_d	Power Dissipation	max I_O		3.0	3.5	W
P_{li}	Input idling power	$I_O = 0$ A, $V_I = 5$ V		0.20		W
P_{RC}	Input standby power	$V_I = 5$ V (turned off with RC)		4.7		mW
I_S	Static Input current	$V_I = 5$ V, max I_O		3.83		A
f_s	Switching frequency	0-100 % of max I_O	270	300	330	kHz

V_{oi}	Output voltage initial setting and accuracy	$T_{ref} = +25^{\circ}\text{C}$, $V_I = 5$ V, max I_O	0.985	1.000	1.015	V
V_O	Output voltage tolerance band	10-100 % of max I_O	0.970		1.030	V
	Idling voltage	$I_O = 0$ A		1.000		V
	Line regulation	max I_O		± 3		mV
	Load regulation	$V_I = 5$ V, 0-100 % of max I_O		± 2		mV
V_{tr}	Load transient voltage deviation	$V_I = 5$ V, Load step 25-75-25 % of max I_O , $di/dt = 2.5$ A/ μs		± 75		mV
t_{tr}	Load transient recovery time	Without Turbo Trans $C_o = 1640$ μF Type C		40		μs
V_{tr}	Load transient voltage deviation	$V_I = 5$ V, Load step 25-75-25 % of max I_O , $di/dt = 2.5$ A/ μs		± 40		mV
t_{tr}	Load transient recovery time	With Turbo Trans $C_o = 1640$ μF Type C; $R_{TT} = 2$ k Ω		30		μs
t_r	Ramp-up time (from 10–90 % of V_{oi})	100 % of max I_O		2.5		ms
t_s	Start-up time (from V_I connection to 90 % of V_{oi})			6.8		ms
t_f	V_I shut-down fall time. (From V_I off to 10 % of V_O)	Max I_O		1.1		ms
		$I_O = 0.1$ A		13.1		ms
t_{RC} t_{inh}	RC start-up time	Max I_O		6.9		ms
	RC shut-down fall time (From RC off to 10 % of V_O)	Max I_O		0.4		ms
		$I_O = 0.1$ A		13.8		ms
I_O	Output current		0		16	A

PMP 5000 series PoL Regulators
Input 4.5 - 14 V, Output up to 16 A / 88 W

1/ 28701- BMR 657 Rev. A November 2017

© Flex

I_{lim}	Current limit threshold	$T_{ref} < \max T_{ref}$	29	A
I_{sc}	Short circuit current	$T_{ref} = 25^{\circ}\text{C}$	29	A
V_{Oac}	Output ripple & noise	See ripple & noise section, $\max I_O$	7.8	mVp-p

PMP 5000 series PoL Regulators
 Input 4.5 - 14 V, Output up to 16 A / 88 W

1/ 28701- BMR 657 Rev. A November 2017

© Flex

1.0V, 16A / 16.0W Typical Characteristics

PMP 5818UW P

Efficiency

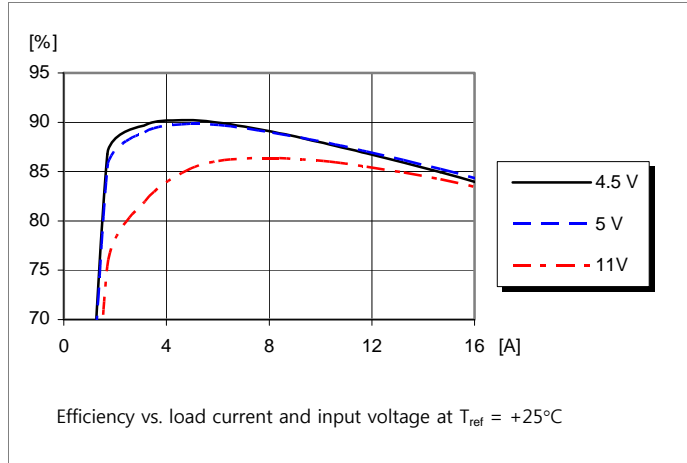

Power Dissipation

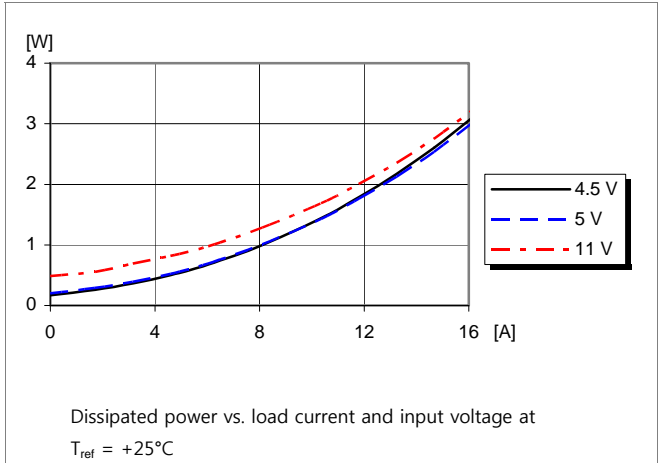

Output Current Derating

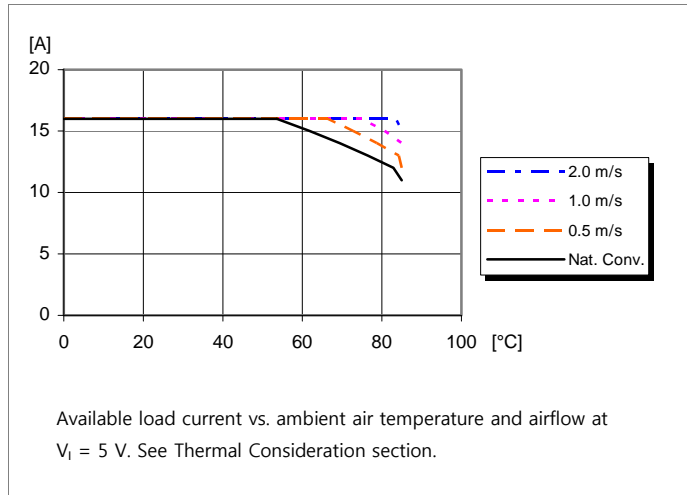

Thermal Resistance

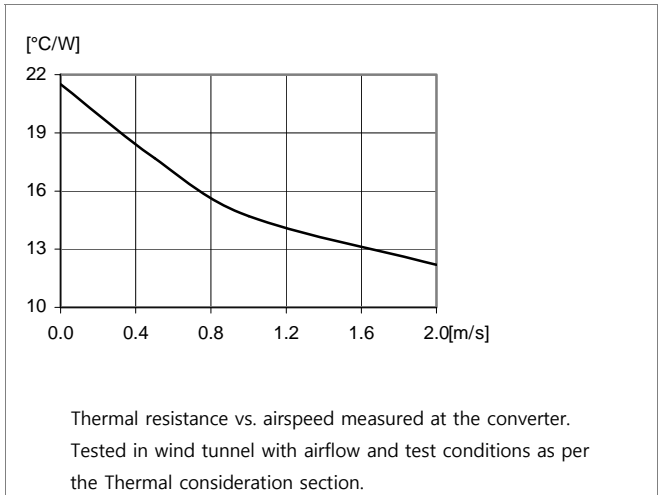

Output Characteristics

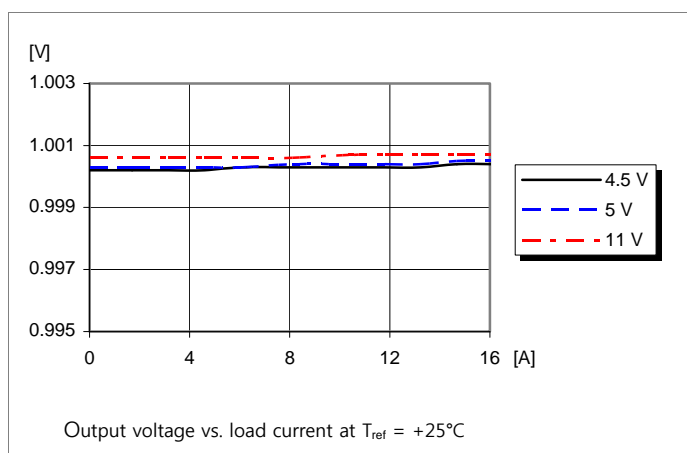

Current Limit Characteristics

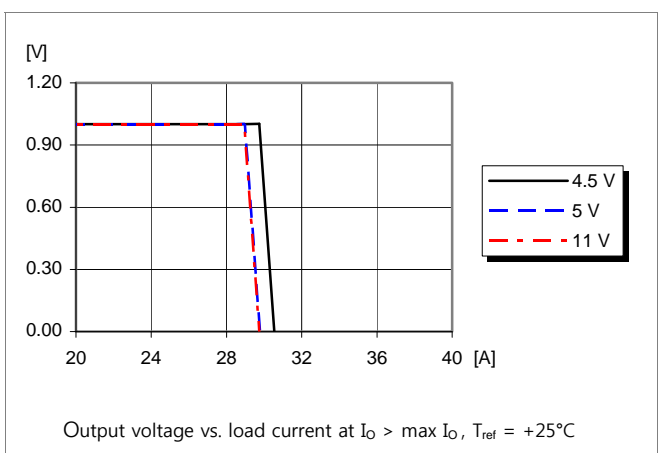

PMP 5000 series PoL Regulators
 Input 4.5 - 14 V, Output up to 16 A / 88 W

1/ 28701- BMR 657 Rev. A November 2017
 © Flex

1.0V, 16A / 16.0W Typical Characteristics

PMP 5818UW P

Start-up

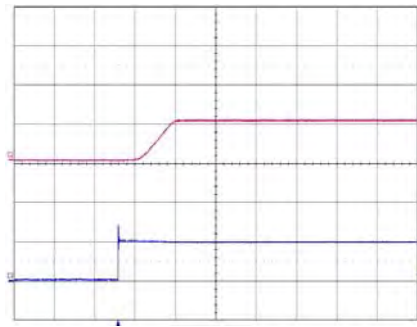

Start-up enabled by connecting V_I at: $T_{ref} = +25^\circ\text{C}$, $V_I = 5\text{ V}$,
 Top trace: output voltage (1 V/div).
 Bottom trace: input voltage (5 V/div).

Shut-down

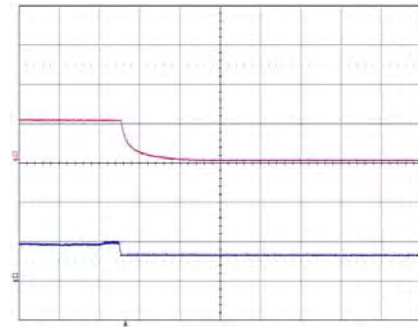

Shut-down enabled by disconnecting V_I at: $T_{ref} = +25^\circ\text{C}$, $V_I = 5\text{ V}$,
 Top trace: output voltage (1 V/div).
 Bottom trace: input voltage (5 V/div).

Output Ripple & Noise

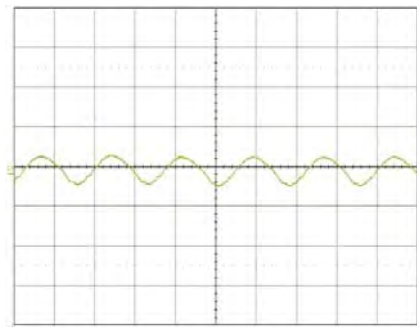

Output voltage ripple at: $T_{ref} = +25^\circ\text{C}$, $V_I = 5\text{ V}$,
 $I_O = 16\text{ A}$ resistive load.
 Trace: output voltage (10 mV/div).
 Time scale: (2 μs /div.).

Output Load Transient Response

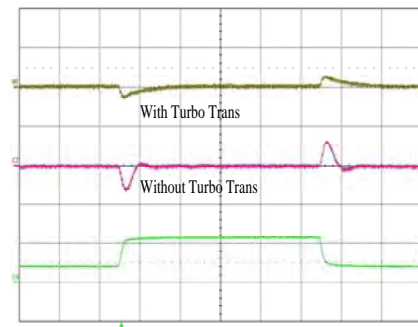

Output voltage response to load current step-change (4-12-4 A) at: $T_{ref} = +25^\circ\text{C}$, $V_I = 5\text{ V}$.
 Top trace: output voltage (100 mV/div).
 Middle trace: output voltage (100 mV/div).
 Bottom trace: load current (10 A/div.).

Output Voltage Adjust (see operating information)

Passive adjust

The resistor value for an adjusted output voltage is calculated by using the equations in the operating information.

$$R_{SET} = 10k\Omega \times \frac{0.69}{V_o - 0.69} - 1.43k\Omega$$

PMP 5000 series PoL Regulators
 Input 4.5 - 14 V, Output up to 16 A / 88 W

1/ 28701- BMR 657 Rev. A November 2017

© Flex

1.2V, 16A / 19.2W Electrical Specification
PMP 5818UW P
 $T_{ref} = -40$ to $+85^{\circ}\text{C}$, $V_I = 4.5$ to 13.2 V, $R_{adj} = 12.1$ k Ω , unless otherwise specified under Conditions.

 Typical values given at: $T_{ref} = +25^{\circ}\text{C}$, $V_I = 5/12$ V, max I_O , unless otherwise specified under Conditions.

 Additional $C_{in} = 330+22$ μF and $C_{out} = 220$ μF . See Operating Information section for selection of capacitor types.

Connect the sense pin, where available, to the output pin.

Characteristics		Conditions	min	typ	max	Unit
V_I	Input voltage range		4.5	5/12	13.2	V
V_{loff}	Turn-off input voltage	Decreasing input voltage	3.9	4.1		V
V_{lon}	Turn-on input voltage	Increasing input voltage		4.3	4.4	V
C_I	Internal input capacitance			44		μF
P_O	Output power		0		19.2	W
η	Efficiency	$V_I = 5$ V	$V_I = 5$ V, 50 % of max I_O	90.3		%
			$V_I = 5$ V, max I_O	86.0		
		$V_I = 12$ V	$V_I = 12$ V, 50 % of max I_O	86.8		
			$V_I = 12$ V, max I_O	84.7		
P_d	Power Dissipation	$V_I = 5$ V, max I_O		3.1	3.6	W
		$V_I = 12$ V, max I_O		3.5	4.0	W
P_{ii}	Input idling power	$V_I = 5$ V, $I_O = 0$ A		0.22		W
		$V_I = 12$ V, $I_O = 0$ A		0.64		W
P_{RC}	Input standby power	$V_I = 5$ V (turned off with RC)		4.7		mW
		$V_I = 12$ V (turned off with RC)		33.9		mW
I_s	Static Input current	$V_I = 5$ V, max I_O		4.5		A
		$V_I = 12$ V, max I_O		1.9		A
f_s	Switching frequency	0-100 % of max I_O	270	300	330	kHz

V_{oi}	Output voltage initial setting and accuracy	$T_{ref} = +25^{\circ}\text{C}$, $V_I = 5/12$ V, max I_O	1.182	1.200	1.218	V
V_O	Output voltage tolerance band	10-100 % of max I_O	1.164		1.236	V
	Idling voltage	$V_I = 5$ V, $I_O = 0$ A		1.199		V
		$V_I = 12$ V, $I_O = 0$ A			1.200	
	Line regulation	max I_O		± 3		mV
Load regulation	$V_I = 5/12$ V, 0-100 % of max I_O		± 2		mV	
V_{tr}	Load transient voltage deviation	$V_I = 5$ V, Load step 25-75-25 % of max I_O , $di/dt = 2.5$ A/ μs		± 75		mV
t_{tr}	Load transient recovery time	Without Turbo Trans $C_o = 1640$ μF Type C		40		μs
V_{tr}	Load transient voltage deviation	$V_I = 5$ V, Load step 25-75-25 % of max I_O , $di/dt = 2.5$ A/ μs		± 40		mV
		With Turbo Trans $C_o = 1640$ μF Type C; $R_{TT} = 2$ k Ω		30		μs
V_{tr}	Load transient voltage deviation	$V_I = 12$ V, Load step 25-75-25 % of max I_O , $di/dt = 2.5$ A/ μs		± 70		mV
t_{tr}	Load transient recovery time	Without Turbo Trans		30		μs

PMP 5000 series PoL Regulators
 Input 4.5 - 14 V, Output up to 16 A / 88 W

1/ 28701- BMR 657 Rev. A November 2017
 © Flex

			$C_o = 1640 \mu\text{F}$ Type C		
V_{tr}	Load transient voltage deviation		$V_I = 12 \text{ V}$, Load step 25-75-25 % of max I_o , $di/dt = 2.5 \text{ A}/\mu\text{s}$	± 55	mV
t_{tr}	Load transient recovery time		With Turbo Trans $C_o = 1640 \mu\text{F}$ Type C; $R_{TT} = 2 \text{ k}\Omega$	30	μs
t_r	Ramp-up time (from 10–90 % of V_o)		$V_I = 5 \text{ V}$, 100 % of max I_o	2.5	ms
t_s	Start-up time (from V_I connection to 90 % of V_o)			6.9	ms
t_r	Ramp-up time (from 10–90 % of V_o)		$V_I = 12 \text{ V}$, 100 % of max I_o	2.7	ms
t_s	Start-up time (from V_I connection to 90 % of V_o)			6.9	ms
t_f	V_I shut-down fall time. (From V_I off to 10 % of V_o)	$V_I = 5 \text{ V}$	Max I_o	1.4	ms
			$I_o = 0.1 \text{ A}$	16.6	ms
		$V_I = 12 \text{ V}$	Max I_o	0.4	ms
			$I_o = 0.1 \text{ A}$	19.8	ms
$t_{RC} t_{inh}$	RC start-up time		$V_I = 5 \text{ V}$, Max I_o	7.0	ms
			$V_I = 12 \text{ V}$, Max I_o	6.8	ms
	RC shut-down fall time (From RC off to 10 % of V_o)	$V_I = 5 \text{ V}$	Max I_o	0.4	ms
			$I_o = 0.1 \text{ A}$	7.1	ms
		$V_I = 12 \text{ V}$	Max I_o	0.3	ms
			$I_o = 0.1 \text{ A}$	19.2	ms
I_o	Output current		0	16	A
I_{lim}	Current limit threshold		$T_{ref} < \max T_{ref}$	30	A
I_{sc}	Short circuit current		$T_{ref} = 25^\circ\text{C}$	30	A
V_{Oac}	Output ripple & noise $V_I = 5 \text{ V}$		See ripple & noise section, max I_o	9.0	mVp-p
V_{Oac}	Output ripple & noise $V_I = 12 \text{ V}$		See ripple & noise section, max I_o	11.3	mVp-p

PMP 5000 series PoL Regulators
 Input 4.5 - 14 V, Output up to 16 A / 88 W

1/ 28701- BMR 657 Rev. A November 2017
 © Flex

1.2V, 16A / 19.2W Typical Characteristics

PMP 5818UW P

Efficiency

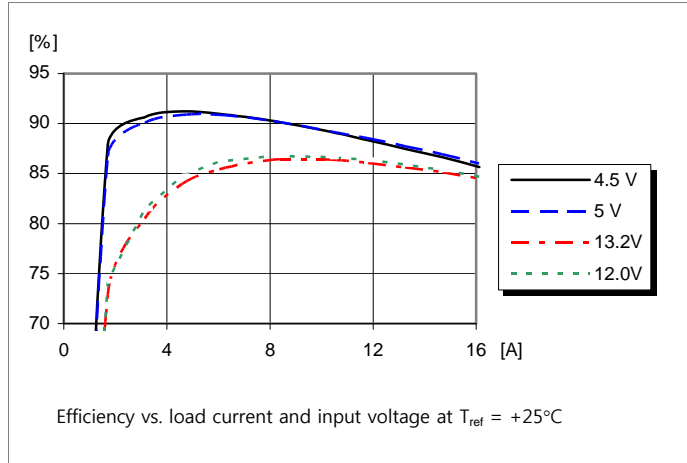

Power Dissipation

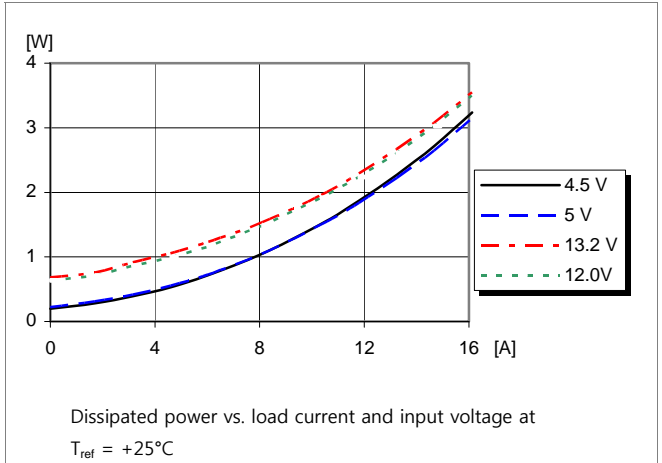

Output Current Derating

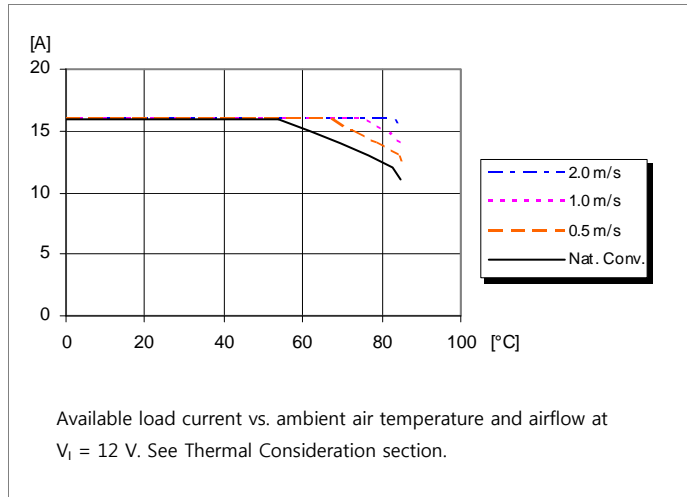

Thermal Resistance

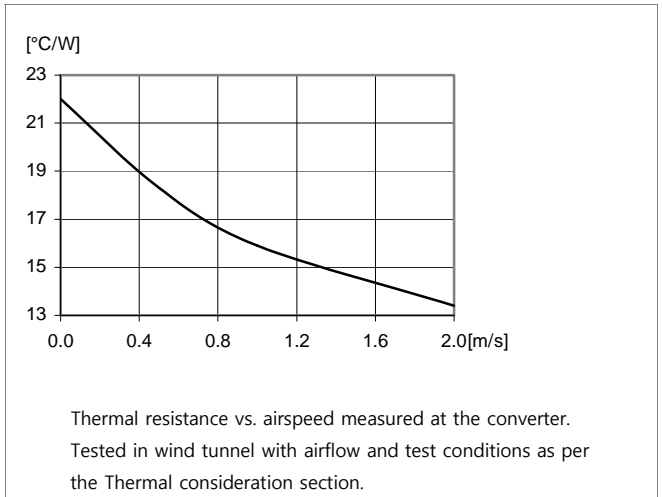

Output Characteristics

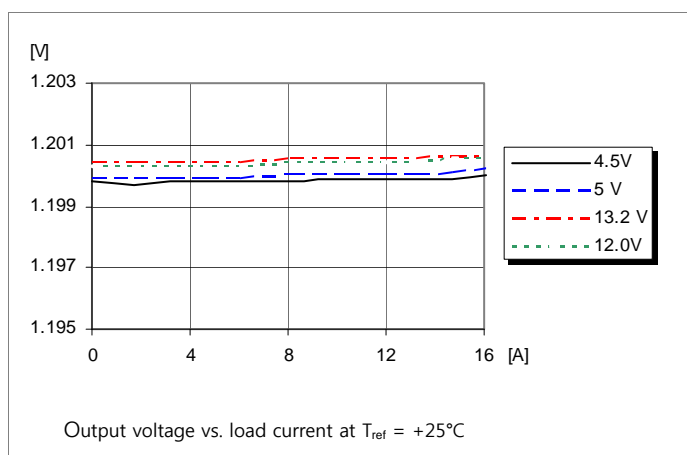

Current Limit Characteristics

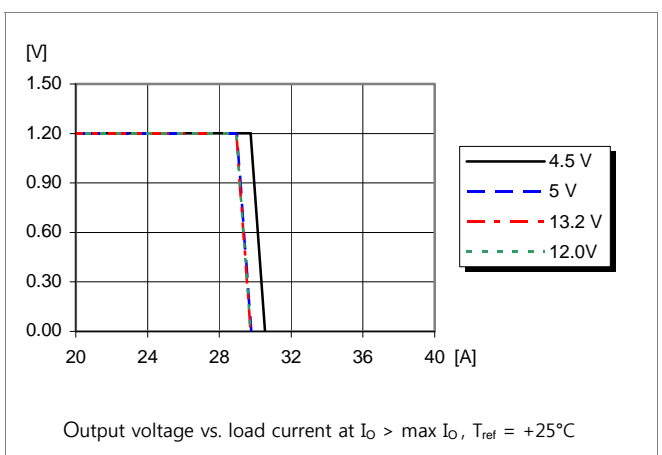

PMP 5000 series PoL Regulators
 Input 4.5 - 14 V, Output up to 16 A / 88 W

1/ 28701- BMR 657 Rev. A November 2017
 © Flex

1.2V, 16A / 19.2W Typical Characteristics $V_I = 5 V$

PMP 5818UW P

Start-up

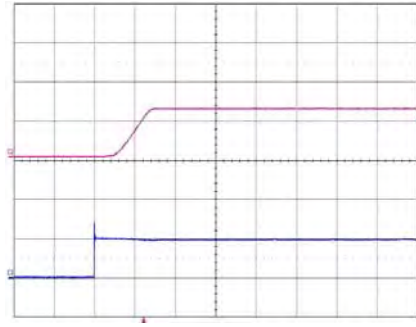

Start-up enabled by connecting V_I at: $T_{ref} = +25^\circ C, V_I = 5 V,$
 Top trace: output voltage (1 V/div).
 Bottom trace: input voltage (5 V/div).

Shut-down

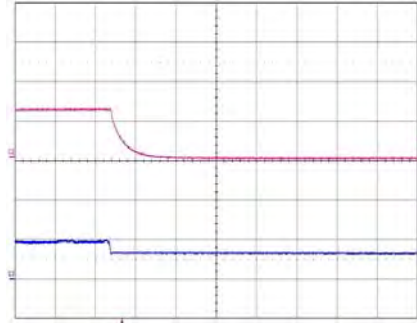

Shut-down enabled by disconnecting V_I at: $T_{ref} = +25^\circ C, V_I = 5 V,$
 Top trace: output voltage (1 V/div).
 Bottom trace: input voltage (5 V/div).

Output Ripple & Noise

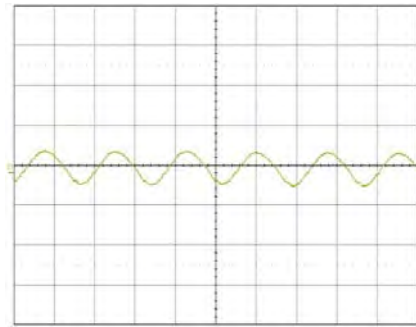

Output voltage ripple at: $T_{ref} = +25^\circ C, V_I = 5 V,$
 $I_O = 16 A$ resistive load.
 Trace: output voltage (10 mV/div).
 Time scale: (2 μs /div.).

Output Load Transient Response

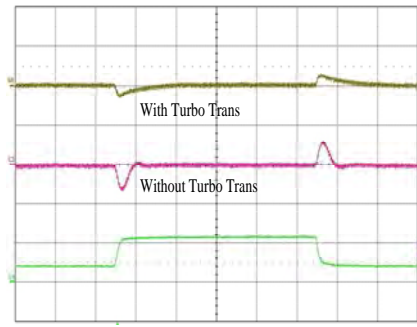

Output voltage response to load current step-change (4-12-4 A) at: $T_{ref} = +25^\circ C, V_I = 5 V.$
 Top trace: output voltage (100 mV/div).
 Middle trace: output voltage (100 mV/div).
 Bottom trace: load current (10 A/div.).

Output Voltage Adjust (see operating information)

Passive adjust

The resistor value for an adjusted output voltage is calculated by using the equations in the operating information.

$$R_{SET} = 10k\Omega \times \frac{0.69}{V_o - 0.69} - 1.43k\Omega$$

PMP 5000 series PoL Regulators
 Input 4.5 - 14 V, Output up to 16 A / 88 W

1/ 28701- BMR 657 Rev. A November 2017

© Flex

1.2V, 16A / 19.2W Typical Characteristics $V_I = 12\text{ V}$

PMP 5818UW P

Start-up

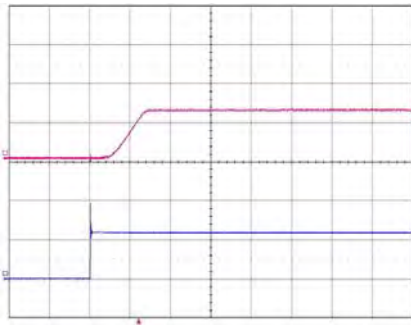

Start-up enabled by connecting V_I at: $T_{ref} = +25^\circ\text{C}$, $V_I = 12\text{ V}$,
 Top trace: output voltage (1 V/div.).
 Bottom trace: input voltage (10 V/div.).

Shut-down

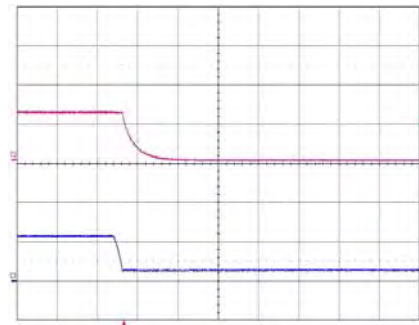

Shut-down enabled by disconnecting V_I at: $T_{ref} = +25^\circ\text{C}$, $V_I = 12\text{ V}$,
 Top trace: output voltage (1.0 V/div.).
 Bottom trace: input voltage (10 V/div.).

Output Ripple & Noise

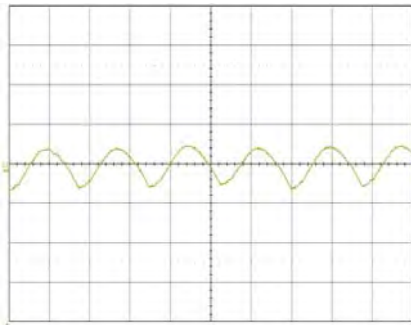

Output voltage ripple at: $T_{ref} = +25^\circ\text{C}$, $V_I = 12\text{ V}$,
 $I_O = 16\text{ A}$ resistive load.
 Trace: output voltage (10 mV/div.).
 Time scale: (2 μs /div.).

Output Load Transient Response

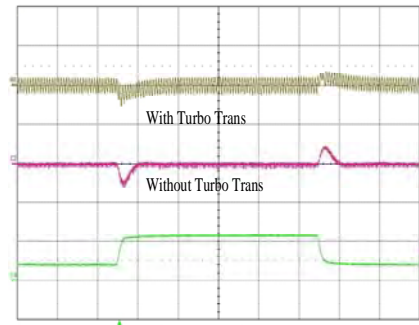

Output voltage response to load current step-change (4-12-4 A) at: $T_{ref} = +25^\circ\text{C}$, $V_I = 12\text{ V}$.
 Top trace: output voltage (100 mV/div.).
 Middle trace: output voltage (100 mV/div.).
 Bottom trace: load current (10 A/div.).

Output Voltage Adjust (see operating information)

Passive adjust

The resistor value for an adjusted output voltage is calculated by using the equations in the operating information.

$$R_{SET} = 10k\Omega \times \frac{0.69}{V_o - 0.69} - 1.43k\Omega$$

Active adjust

The output voltage may be adjusted using a current/voltage applied to the V_{adj} pin. This current/voltage is calculated by using the equations in the operating information.

PMP 5000 series PoL Regulators Input 4.5 - 14 V, Output up to 16 A / 88 W	1/ 28701- BMR 657 Rev. A November 2017
	© Flex

1.5V, 16A / 24.0W Electrical Specification

PMP 5818UW P

$T_{ref} = -40$ to $+85^{\circ}C$, $V_I = 4.5$ to 14 V, $R_{adj} = 7.09$ k Ω , unless otherwise specified under Conditions.

Typical values given at: $T_{ref} = +25^{\circ}C$, $V_I = 5/12$ V, max I_O , unless otherwise specified under Conditions.

Additional $C_{in} = 330+22$ μF and $C_{out} = 220$ μF . See Operating Information section for selection of capacitor types.

Connect the sense pin, where available, to the output pin.

Characteristics		Conditions	min	typ	max	Unit
V_I	Input voltage range		4.5	5/12	14	V
V_{loff}	Turn-off input voltage	Decreasing input voltage	3.9	4.1		V
V_{lon}	Turn-on input voltage	Increasing input voltage		4.3	4.4	V
C_I	Internal input capacitance			44		μF
P_O	Output power		0		24	W
η	Efficiency	$V_I = 5$ V	$V_I = 5$ V, 50 % of max I_O	91.5		%
			$V_I = 5$ V, max I_O	87.9		
		$V_I = 12$ V	$V_I = 12$ V, 50 % of max I_O	87.5		
			$V_I = 12$ V, max I_O	86.1		
P_d	Power Dissipation	$V_I = 5$ V, max I_O		3.3	3.8	W
		$V_I = 12$ V, max I_O		3.9	4.4	W
P_{ii}	Input idling power	$V_I = 5$ V, $I_O = 0$ A		0.27		W
		$V_I = 12$ V, $I_O = 0$ A		0.86		W
P_{RC}	Input standby power	$V_I = 5$ V (turned off with RC)		4.7		mW
		$V_I = 12$ V (turned off with RC)		26.4		mW
I_S	Static Input current	$V_I = 5$ V, max I_O		5.5		A
		$V_I = 12$ V, max I_O		2.3		A
f_s	Switching frequency	0-100 % of max I_O	270	300	330	kHz

V_{oi}	Output voltage initial setting and accuracy	$T_{ref} = +25^{\circ}C$, $V_I = 5/12$ V, max I_O	1.477	1.500	1.523	V
V_O	Output voltage tolerance band	10-100 % of max I_O	1.455		1.545	V
	Idling voltage	$V_I = 5$ V, $I_O = 0$ A		1.500		V
		$V_I = 12$ V, $I_O = 0$ A			1.500	
	Line regulation	max I_O		± 3		mV
Load regulation	$V_I = 5/12$ V, 0-100 % of max I_O		± 2		mV	
V_{tr}	Load transient voltage deviation	$V_I = 5$ V, Load step 25-75-25 % of max I_O , $di/dt = 2.5$ A/ μs		± 75		mV
t_{tr}	Load transient recovery time	Without Turbo Trans $C_o = 1640$ μF Type C		40		μs
V_{tr}	Load transient voltage deviation	$V_I = 5$ V, Load step 25-75-25 % of max I_O , $di/dt = 2.5$ A/ μs		± 40		mV
		With Turbo Trans $C_o = 1640$ μF Type C; $R_{TT} = 2$ k Ω		30		μs
V_{tr}	Load transient voltage deviation	$V_I = 12$ V, Load step 25-75-25 % of max I_O , $di/dt = 2.5$ A/ μs		± 70		mV
		Without Turbo Trans		30		μs

PMP 5000 series PoL Regulators
 Input 4.5 - 14 V, Output up to 16 A / 88 W

1/ 28701- BMR 657 Rev. A November 2017
 © Flex

			$C_o = 1640 \mu\text{F}$ Type C		
V_{tr}	Load transient voltage deviation		$V_I = 12 \text{ V}$, Load step 25-75-25 % of max I_o , $di/dt = 2.5 \text{ A}/\mu\text{s}$	± 55	mV
t_{tr}	Load transient recovery time		With Turbo Trans $C_o = 1640 \mu\text{F}$ Type C; $R_{TT} = 2 \text{ k}\Omega$	30	μs
t_r	Ramp-up time (from 10–90 % of V_o)		$V_I = 5 \text{ V}$, 100 % of max I_o	3.1	ms
t_s	Start-up time (from V_I connection to 90 % of V_o)			7.0	ms
t_r	Ramp-up time (from 10–90 % of V_o)		$V_I = 12 \text{ V}$, 100 % of max I_o	3.0	ms
t_s	Start-up time (from V_I connection to 90 % of V_o)			6.9	ms
t_f	V_I shut-down fall time. (From V_I off to 10 % of V_o)	$V_I = 5 \text{ V}$	Max I_o	1.6	ms
			$I_o = 0.1 \text{ A}$	24.6	ms
		$V_I = 12 \text{ V}$	Max I_o	0.6	ms
			$I_o = 0.1 \text{ A}$	21.4	ms
$t_{RC} t_{inh}$	RC start-up time		$V_I = 5 \text{ V}$, Max I_o	7.0	ms
			$V_I = 12 \text{ V}$, Max I_o	6.9	ms
	RC shut-down fall time (From RC off to 10 % of V_o)	$V_I = 5 \text{ V}$	Max I_o	0.5	ms
			$I_o = 0.1 \text{ A}$	22.4	ms
		$V_I = 12 \text{ V}$	Max I_o	0.5	ms
			$I_o = 0.1 \text{ A}$	22.3	ms
I_o	Output current		0	16	A
I_{lim}	Current limit threshold		$T_{ref} < \max T_{ref}$	30	A
I_{sc}	Short circuit current		$T_{ref} = 25^\circ\text{C}$	30	A
V_{Oac}	Output ripple & noise $V_I = 5 \text{ V}$		See ripple & noise section, max I_o	10.2	mVp-p
V_{Oac}	Output ripple & noise $V_I = 12 \text{ V}$		See ripple & noise section, max I_o	13.4	mVp-p

PMP 5000 series PoL Regulators
 Input 4.5 - 14 V, Output up to 16 A / 88 W

1/ 28701- BMR 657 Rev. A November 2017
 © Flex

1.5V, 16A / 24.0W Typical Characteristics

PMP 5818UW P

Efficiency

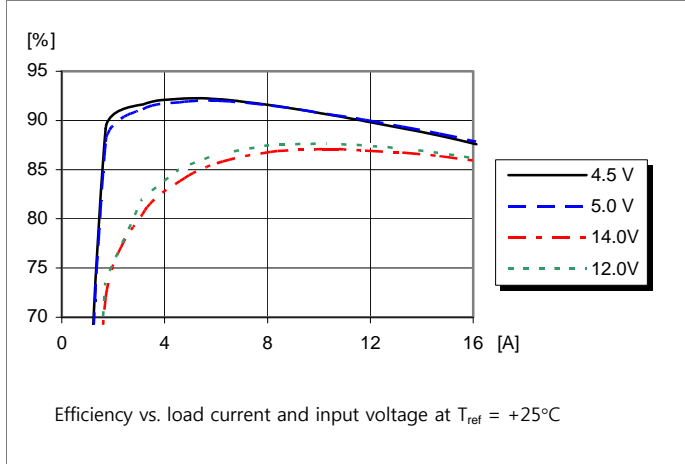

Power Dissipation

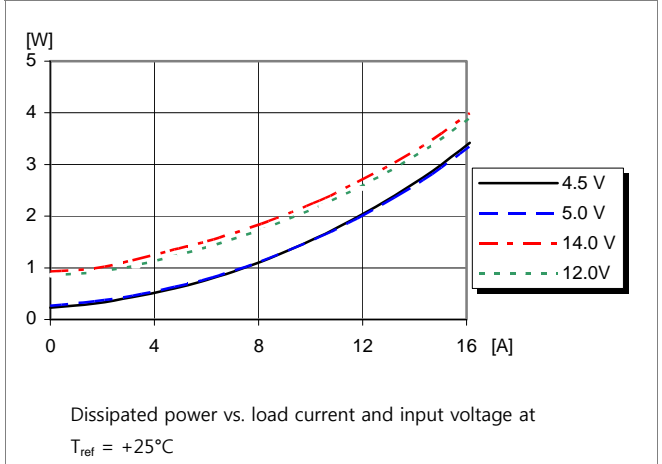

Output Current Derating

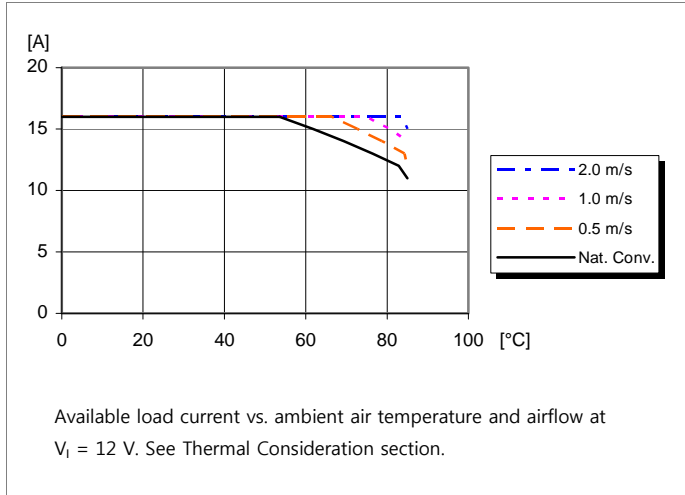

Thermal Resistance

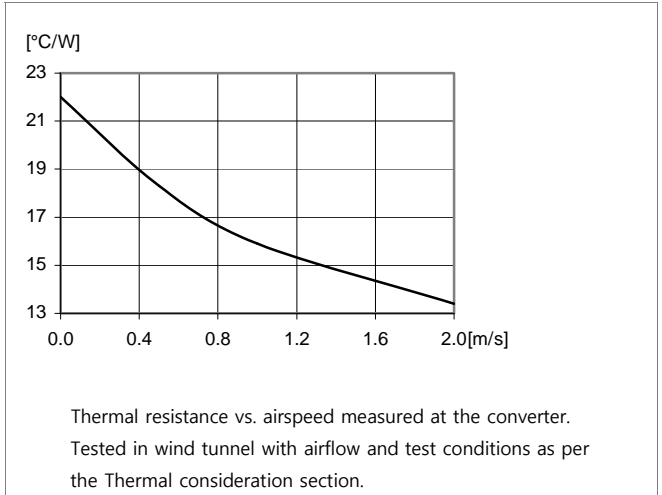

Output Characteristics

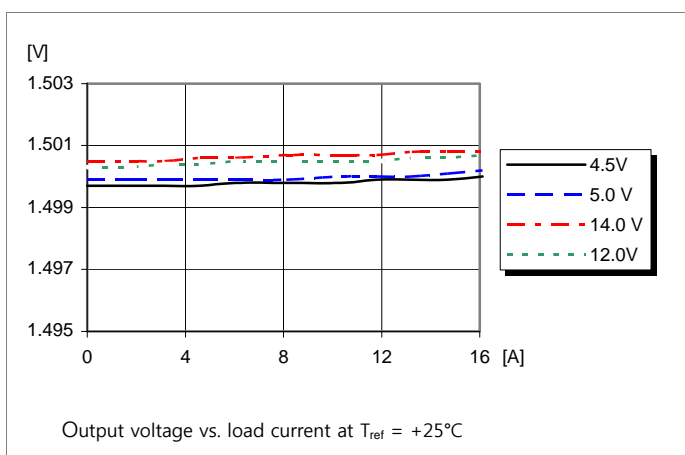

Current Limit Characteristics

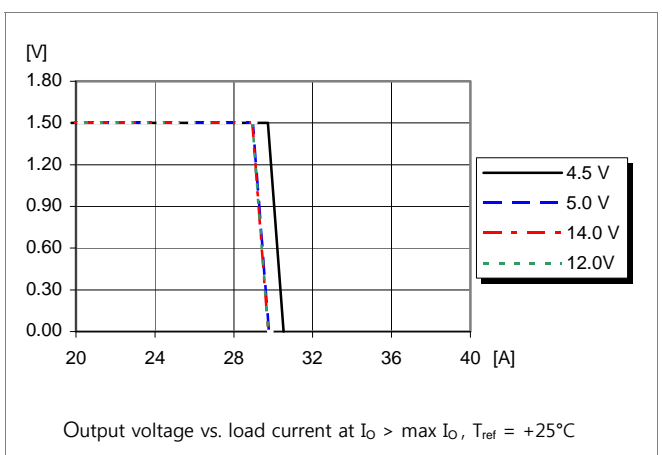

PMP 5000 series PoL Regulators
 Input 4.5 - 14 V, Output up to 16 A / 88 W

1/ 28701- BMR 657 Rev. A November 2017
 © Flex

1.5V, 16A / 24.0W Typical Characteristics $V_I = 5 V$

PMP 5818UW P

Start-up

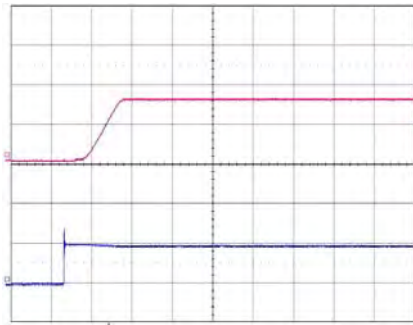

Start-up enabled by connecting V_I at: $T_{ref} = +25^\circ C, V_I = 5 V,$
 Top trace: output voltage (1 V/div).
 Bottom trace: input voltage (5 V/div).

Shut-down

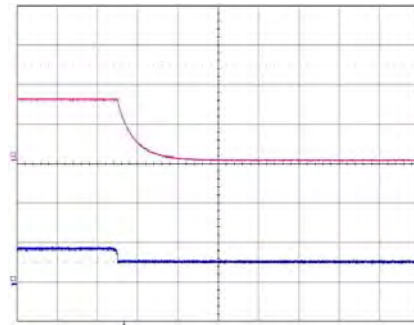

Shut-down enabled by disconnecting V_I at: $T_{ref} = +25^\circ C, V_I = 5 V,$
 Top trace: output voltage (1 V/div).
 Bottom trace: input voltage (5 V/div).

Output Ripple & Noise

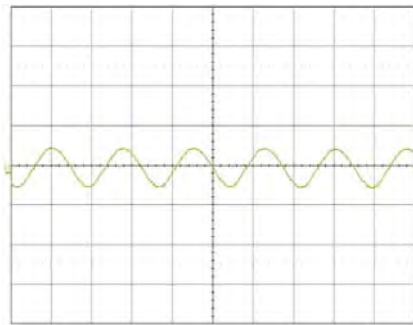

Output voltage ripple at: $T_{ref} = +25^\circ C, V_I = 5 V,$
 $I_O = 16 A$ resistive load.
 Trace: output voltage (10 mV/div).
 Time scale: (2 μs /div).

Output Load Transient Response

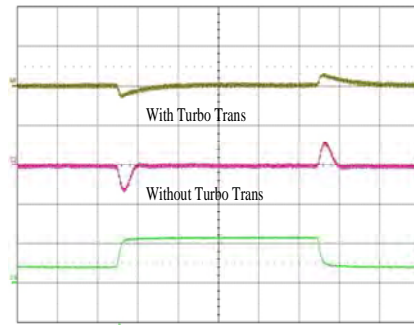

Output voltage response to load current step-change (4-12-4 A) at: $T_{ref} = +25^\circ C, V_I = 5 V.$
 Top trace: output voltage (100 mV/div).
 Middle trace: output voltage (100 mV/div).
 Bottom trace: load current (10 A/div).

Output Voltage Adjust (see operating information)

Passive adjust

The resistor value for an adjusted output voltage is calculated by using the equations in the operating information.

$$R_{SET} = 10k\Omega \times \frac{0.69}{V_o - 0.69} - 1.43k\Omega$$

PMP 5000 series PoL Regulators
 Input 4.5 - 14 V, Output up to 16 A / 88 W

1/ 28701- BMR 657 Rev. A November 2017
 © Flex

1.5V, 16A / 24.0W Typical Characteristics $V_I = 12\text{ V}$

PMP 5818UW P

Start-up

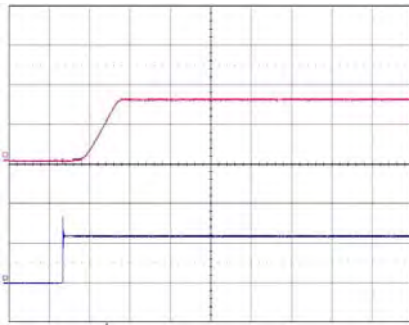

Start-up enabled by connecting V_I at: $T_{ref} = +25^\circ\text{C}$, $V_I = 12\text{ V}$,
 Top trace: output voltage (1 V/div).
 Bottom trace: input voltage (10 V/div).

Shut-down

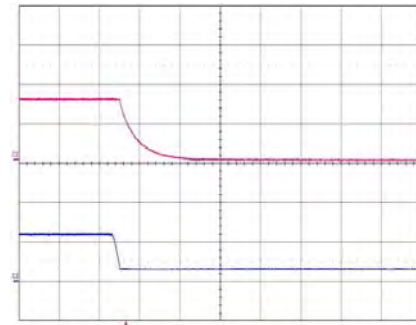

Shut-down enabled by disconnecting V_I at: $T_{ref} = +25^\circ\text{C}$, $V_I = 12\text{ V}$,
 Top trace: output voltage (1 V/div).
 Bottom trace: input voltage (5 V/div).

Output Ripple & Noise

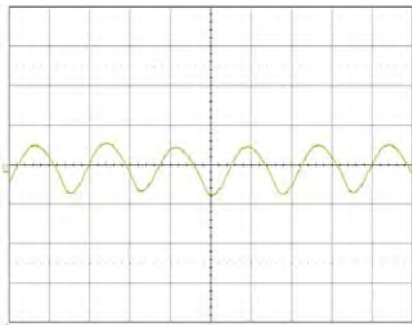

Output voltage ripple at: $T_{ref} = +25^\circ\text{C}$, $V_I = 12\text{ V}$,
 $I_O = 16\text{ A}$ resistive load.
 Trace: output voltage (10 mV/div).
 Time scale: (2 μs /div).

Output Load Transient Response

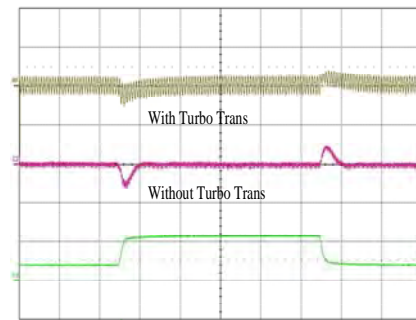

Output voltage response to load current step-change (4-12-4 A) at: $T_{ref} = +25^\circ\text{C}$, $V_I = 12\text{ V}$.
 Top trace: output voltage (100 mV/div).
 Middle trace: output voltage (100 mV/div).
 Bottom trace: load current (10 A/div).

Output Voltage Adjust (see operating information)

Passive adjust

The resistor value for an adjusted output voltage is calculated by using the equations in the operating information.

$$R_{SET} = 10k\Omega \times \frac{0.69}{V_o - 0.69} - 1.43k\Omega$$

Active adjust

The output voltage may be adjusted using a current/voltage applied to the V_{adj} pin. This current/voltage is calculated by using the equations in the operating information.

PMP 5000 series PoL Regulators
 Input 4.5 - 14 V, Output up to 16 A / 88 W

1/ 28701- BMR 657 Rev. A November 2017

© Flex

1.8V, 16A / 28.8W Electrical Specification
PMP 5818UW P
 $T_{ref} = -40$ to $+85^{\circ}\text{C}$, $V_I = 4.5$ to 14 V, $R_{adj} = 4.78$ k Ω , unless otherwise specified under Conditions.

 Typical values given at: $T_{ref} = +25^{\circ}\text{C}$, $V_I = 5/12$ V, max I_O , unless otherwise specified under Conditions.

 Additional $C_{in} = 330+22$ μF and $C_{out} = 220$ μF . See Operating Information section for selection of capacitor types.

Connect the sense pin, where available, to the output pin.

Characteristics		Conditions	min	typ	max	Unit
V_I	Input voltage range		4.5	5/12	14	V
V_{loff}	Turn-off input voltage	Decreasing input voltage	3.9	4.1		V
V_{lon}	Turn-on input voltage	Increasing input voltage		4.3	4.4	V
C_I	Internal input capacitance			44		μF
P_O	Output power		0		28.8	W
η	Efficiency	$V_I = 5$ V	$V_I = 5$ V, 50 % of max I_O	92.5		%
			$V_I = 5$ V, max I_O	89.3		
		$V_I = 12$ V	$V_I = 12$ V, 50 % of max I_O	88.7		
			$V_I = 12$ V, max I_O	87.1		
P_d	Power Dissipation	$V_I = 5$ V, max I_O		3.5	4.0	W
		$V_I = 12$ V, max I_O		4.3	4.8	W
P_{ii}	Input idling power	$V_I = 5$ V, $I_O = 0$ A		0.30		W
		$V_I = 12$ V, $I_O = 0$ A		0.75		W
P_{RC}	Input standby power	$V_I = 5$ V (turned off with RC)		1.6		mW
		$V_I = 12$ V (turned off with RC)		33.9		mW
I_S	Static Input current	$V_I = 5$ V, max I_O		6.5		A
		$V_I = 12$ V, max I_O		2.8		A
f_s	Switching frequency	0-100 % of max I_O	270	300	330	kHz

V_{oi}	Output voltage initial setting and accuracy	$T_{ref} = +25^{\circ}\text{C}$, $V_I = 5/12$ V, max I_O	1.773	1.800	1.827	V
V_O	Output voltage tolerance band	10-100 % of max I_O	1.746		1.854	V
	Idling voltage	$V_I = 5$ V, $I_O = 0$ A		1.801		V
		$V_I = 12$ V, $I_O = 0$ A			1.802	
	Line regulation	max I_O		± 3		mV
Load regulation	$V_I = 5/12$ V, 0-100 % of max I_O		± 2		mV	
V_{tr}	Load transient voltage deviation	$V_I = 5$ V, Load step 25-75-25 % of max I_O , $di/dt = 2.5$ A/ μs		± 75		mV
t_{tr}	Load transient recovery time	Without Turbo Trans $C_o = 1640$ μF Type C		40		μs
V_{tr}	Load transient voltage deviation	$V_I = 5$ V, Load step 25-75-25 % of max I_O , $di/dt = 2.5$ A/ μs		± 40		mV
t_{tr}	Load transient recovery time	With Turbo Trans $C_o = 1640$ μF Type C; $R_{TT} = 2$ k Ω		30		μs
V_{tr}	Load transient voltage deviation	$V_I = 12$ V, Load step 25-75-25 % of max I_O , $di/dt = 2.5$ A/ μs		± 70		mV
t_{tr}	Load transient recovery time	Without Turbo Trans		30		μs

PMP 5000 series PoL Regulators
 Input 4.5 - 14 V, Output up to 16 A / 88 W

1/ 28701- BMR 657 Rev. A November 2017
 © Flex

			$C_o = 1640 \mu\text{F}$ Type C		
V_{tr}	Load transient voltage deviation		$V_I = 12 \text{ V}$, Load step 25-75-25 % of max I_o , $di/dt = 2.5 \text{ A}/\mu\text{s}$	± 60	mV
t_{tr}	Load transient recovery time		With Turbo Trans $C_o = 1640 \mu\text{F}$ Type C; $R_{TT} = 2 \text{ k}\Omega$	30	μs
t_r	Ramp-up time (from 10–90 % of V_o)		$V_I = 5 \text{ V}$, 100 % of max I_o	2.9	ms
t_s	Start-up time (from V_I connection to 90 % of V_o)			7.0	ms
t_r	Ramp-up time (from 10–90 % of V_o)		$V_I = 12 \text{ V}$, 100 % of max I_o	2.8	ms
t_s	Start-up time (from V_I connection to 90 % of V_o)			7.0	ms
t_f	V_I shut-down fall time. (From V_I off to 10 % of V_o)	$V_I = 5 \text{ V}$	Max I_o	1.5	ms
			$I_o = 0.1 \text{ A}$	26.2	ms
		$V_I = 12 \text{ V}$	Max I_o	0.7	ms
			$I_o = 0.1 \text{ A}$	29.2	ms
$t_{RC} t_{inh}$	RC start-up time		$V_I = 5 \text{ V}$, Max I_o	7.0	ms
			$V_I = 12 \text{ V}$, Max I_o	6.9	ms
	RC shut-down fall time (From RC off to 10 % of V_o)	$V_I = 5 \text{ V}$	Max I_o	0.6	ms
			$I_o = 0.1 \text{ A}$	26.5	ms
		$V_I = 12 \text{ V}$	Max I_o	0.6	ms
			$I_o = 0.1 \text{ A}$	27.4	ms
I_o	Output current		0	16	A
I_{lim}	Current limit threshold		$T_{ref} < \max T_{ref}$	30	A
I_{sc}	Short circuit current		$T_{ref} = 25^\circ\text{C}$	30	A
V_{Oac}	Output ripple & noise $V_I = 5 \text{ V}$		See ripple & noise section, max I_o	11.3	mVp-p
V_{Oac}	Output ripple & noise $V_I = 12 \text{ V}$		See ripple & noise section, max I_o	14.8	mVp-p

PMP 5000 series PoL Regulators
 Input 4.5 - 14 V, Output up to 16 A / 88 W

1/ 28701- BMR 657 Rev. A November 2017

© Flex

1.8V, 16A / 28.8W Typical Characteristics

PMP 5818UW P

Efficiency

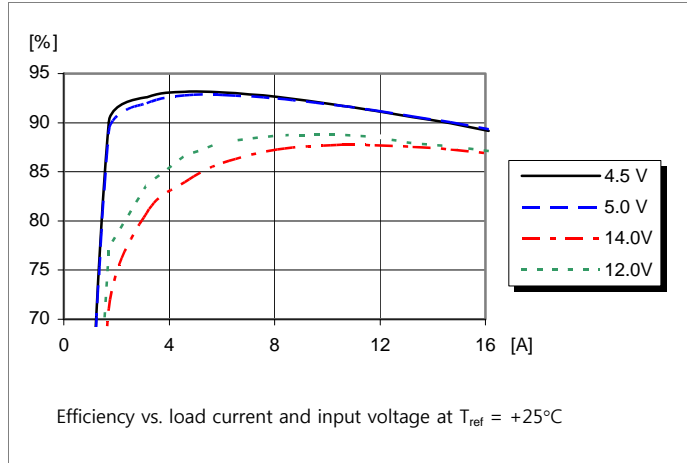

Power Dissipation

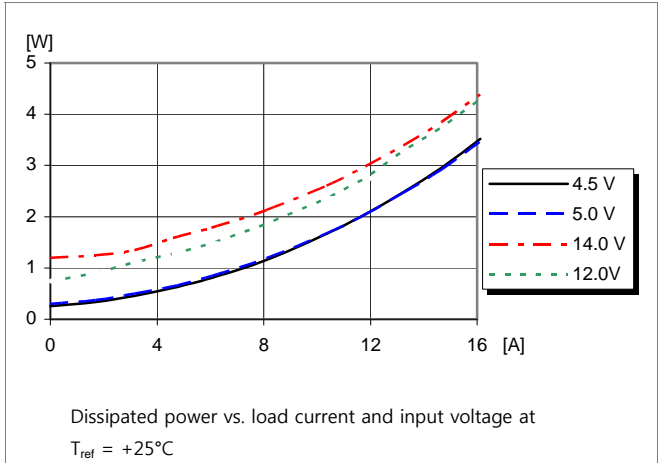

Output Current Derating

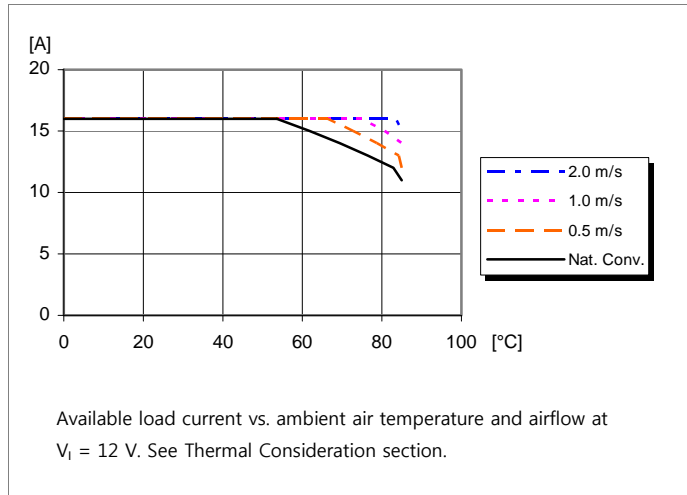

Thermal Resistance

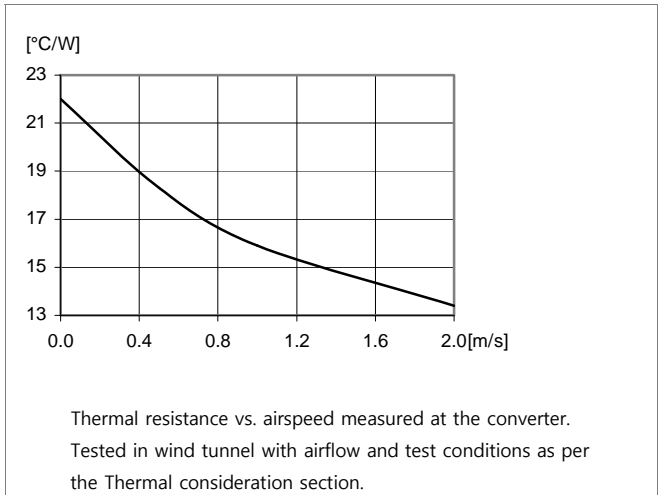

Output Characteristics

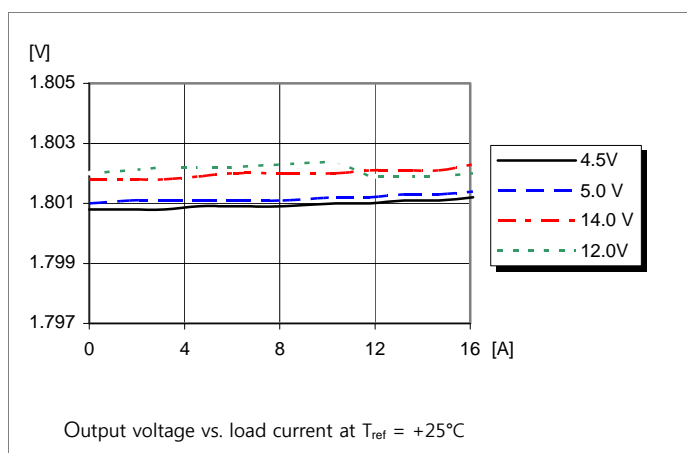

Current Limit Characteristics

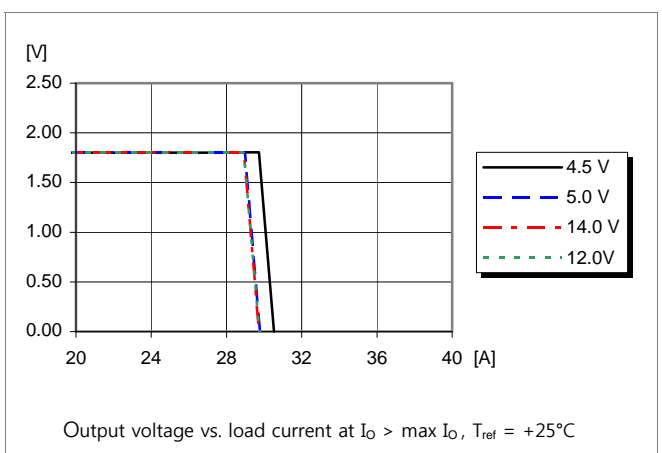

PMP 5000 series PoL Regulators
 Input 4.5 - 14 V, Output up to 16 A / 88 W

1/ 28701- BMR 657 Rev. A November 2017

© Flex

1.8V, 16A / 28.8W Typical Characteristics $V_I = 5 V$

PMP 5818UW P

Start-up

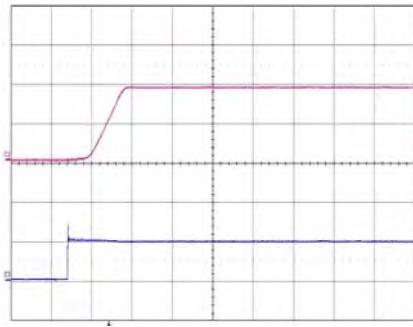

Start-up enabled by connecting V_I at: $T_{ref} = +25^\circ C, V_I = 5 V,$
 Top trace: output voltage (1 V/div).
 Bottom trace: input voltage (5 V/div).

Shut-down

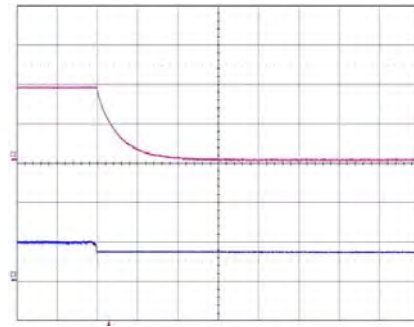

Shut-down enabled by disconnecting V_I at: $T_{ref} = +25^\circ C, V_I = 5 V,$
 Top trace: output voltage (1 V/div).
 Bottom trace: input voltage (5 V/div).

Output Ripple & Noise

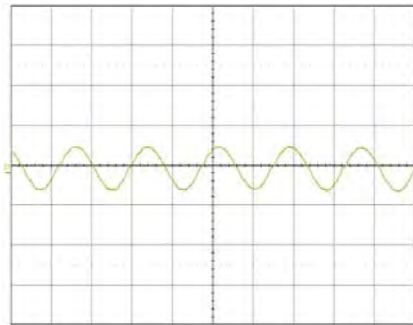

Output voltage ripple at: $T_{ref} = +25^\circ C, V_I = 5 V,$
 $I_O = 16 A$ resistive load.
 Trace: output voltage (10 mV/div).
 Time scale: (2 μs /div.).

Output Load Transient Response

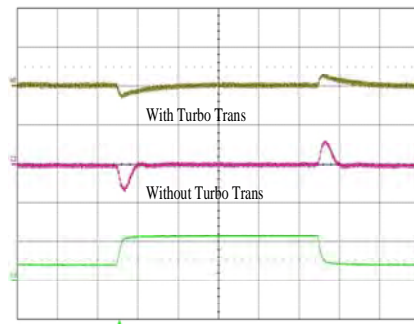

Output voltage response to load current step-change (4-12-4 A) at: $T_{ref} = +25^\circ C, V_I = 5 V.$
 Top trace: output voltage (100 mV/div).
 Middle trace: output voltage (100 mV/div).
 Bottom trace: load current (10 A/div.).

Output Voltage Adjust (see operating information)

Passive adjust

The resistor value for an adjusted output voltage is calculated by using the equations in the operating information.

$$R_{SET} = 10k\Omega \times \frac{0.69}{V_o - 0.69} - 1.43k\Omega$$

PMP 5000 series PoL Regulators
 Input 4.5 - 14 V, Output up to 16 A / 88 W

1/ 28701- BMR 657 Rev. A November 2017
 © Flex

1.8V, 16A / 28.8W Typical Characteristics $V_I = 12\text{ V}$

PMP 5818UW P

Start-up

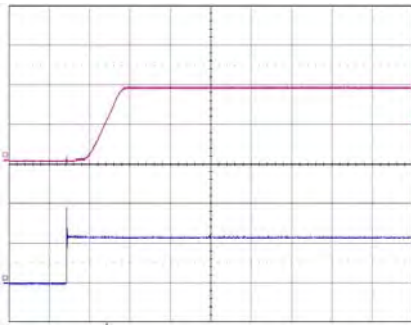

Start-up enabled by connecting V_I at: $T_{ref} = +25^\circ\text{C}$, $V_I = 12\text{ V}$,
 Top trace: output voltage (1 V/div).
 Bottom trace: input voltage (10 V/div).

Shut-down

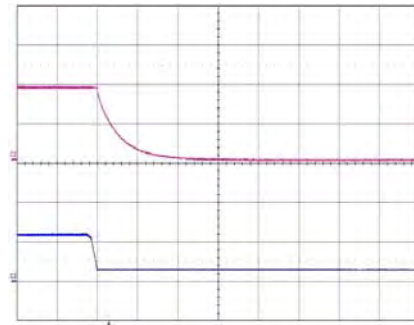

Shut-down enabled by disconnecting V_I at: $T_{ref} = +25^\circ\text{C}$, $V_I = 12\text{ V}$,
 Top trace: output voltage (1 V/div).
 Bottom trace: input voltage (10 V/div).

Output Ripple & Noise

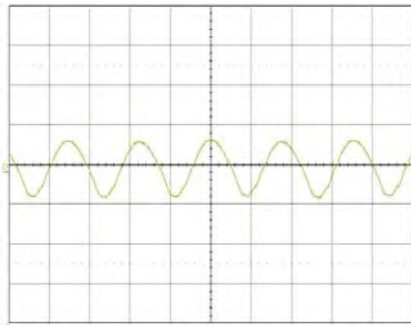

Output voltage ripple at: $T_{ref} = +25^\circ\text{C}$, $V_I = 12\text{ V}$,
 $I_O = 16\text{ A}$ resistive load.
 Trace: output voltage (10 mV/div).
 Time scale: (2 μs /div.).

Output Load Transient Response

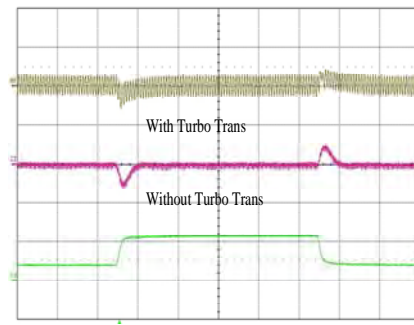

Output voltage response to load current step-change (4-12-4 A) at: $T_{ref} = +25^\circ\text{C}$, $V_I = 12\text{ V}$.
 Top trace: output voltage (100 mV/div).
 Middle trace: output voltage (100 mV/div).
 Bottom trace: load current (10 A/div.).

Output Voltage Adjust (see operating information)

Passive adjust

The resistor value for an adjusted output voltage is calculated by using the equations in the operating information.

$$R_{SET} = 10k\Omega \times \frac{0.69}{V_o - 0.69} - 1.43k\Omega$$

Active adjust

The output voltage may be adjusted using a current/voltage applied to the V_{adj} pin. This current/voltage is calculated by using the equations in the operating information.

PMP 5000 series PoL Regulators
Input 4.5 - 14 V, Output up to 16 A / 88 W

1/ 28701- BMR 657 Rev. A November 2017
© Flex

2.5V, 16A / 40.0W Electrical Specification

PMP 5818UW P

$T_{ref} = -40$ to $+85^{\circ}C$, $V_I = 4.5$ to 14 V, $R_{adj} = 2.38$ k Ω , unless otherwise specified under Conditions.

Typical values given at: $T_{ref} = +25^{\circ}C$, $V_I = 5/12$ V, max I_O , unless otherwise specified under Conditions.

Additional $C_{in} = 330+22$ μF and $C_{out} = 220$ μF . See Operating Information section for selection of capacitor types.

Connect the sense pin, where available, to the output pin.

Characteristics		Conditions	min	typ	max	Unit
V_I	Input voltage range		4.5	5/12	14	V
V_{loff}	Turn-off input voltage	Decreasing input voltage	3.9	4.1		V
V_{lon}	Turn-on input voltage	Increasing input voltage		4.3	4.4	V
C_I	Internal input capacitance			44		μF
P_O	Output power		0		33	W
η	Efficiency	$V_I = 5$ V	$V_I = 5$ V, 50 % of max I_O	94.2		%
			$V_I = 5$ V, max I_O	91.9		
		$V_I = 12$ V	$V_I = 12$ V, 50 % of max I_O	90.2		
			$V_I = 12$ V, max I_O	89.4		
P_d	Power Dissipation	$V_I = 5$ V, max I_O		3.6	4.1	W
		$V_I = 12$ V, max I_O		4.8	5.3	W
P_{ii}	Input idling power	$V_I = 5$ V, $I_O = 0$ A		0.34		W
		$V_I = 12$ V, $I_O = 0$ A		0.99		W
P_{RC}	Input standby power	$V_I = 5$ V (turned off with RC)		4.7		mW
		$V_I = 12$ V (turned off with RC)		26.4		mW
I_s	Static Input current	$V_I = 5$ V, max I_O		8.8		A
		$V_I = 12$ V, max I_O		3.8		A
f_s	Switching frequency	0-100 % of max I_O	270	300	330	kHz

V_{oi}	Output voltage initial setting and accuracy	$T_{ref} = +25^{\circ}C$, $V_I = 5/12$ V, max I_O	2.462	2.500	2.538	V
V_O	Output voltage tolerance band	10-100 % of max I_O	2.425		2.575	V
	Idling voltage	$V_I = 5$ V, $I_O = 0$ A		2.501		V
		$V_I = 12$ V, $I_O = 0$ A			2.503	
	Line regulation	max I_O		± 3		mV
Load regulation	$V_I = 5/12$ V, 0-100 % of max I_O		± 2		mV	
V_{tr}	Load transient voltage deviation	$V_I = 5$ V, Load step 25-75-25 % of max I_O , $di/dt = 2.5$ A/ μs		± 75		mV
t_{tr}	Load transient recovery time	Without Turbo Trans $C_o = 1640$ μF Type C		40		μs
V_{tr}	Load transient voltage deviation	$V_I = 5$ V, Load step 25-75-25 % of max I_O , $di/dt = 2.5$ A/ μs		± 40		mV
		With Turbo Trans $C_o = 1640$ μF Type C; $R_{TT} = 2$ k Ω		30		μs
V_{tr}	Load transient voltage deviation	$V_I = 12$ V, Load step 25-75-25 % of max I_O , $di/dt = 2.5$ A/ μs		± 70		mV
		Without Turbo Trans		30		μs

PMP 5000 series PoL Regulators
Input 4.5 - 14 V, Output up to 16 A / 88 W

1/ 28701- BMR 657 Rev. A November 2017
© Flex

			$C_o = 1640 \mu\text{F}$ Type C		
V_{tr}	Load transient voltage deviation		$V_I = 12 \text{ V}$, Load step 25-75-25 % of max I_o , $di/dt = 2.5 \text{ A}/\mu\text{s}$	± 65	mV
t_{tr}	Load transient recovery time		With Turbo Trans $C_o = 1640 \mu\text{F}$ Type C; $R_{TT} = 2 \text{ k}\Omega$	30	μs
t_r	Ramp-up time (from 10–90 % of V_o)		$V_I = 5 \text{ V}$, 100 % of max I_o	3.2	ms
t_s	Start-up time (from V_I connection to 90 % of V_o)			7.1	ms
t_r	Ramp-up time (from 10–90 % of V_o)		$V_I = 12 \text{ V}$, 100 % of max I_o	3.1	ms
t_s	Start-up time (from V_I connection to 90 % of V_o)			6.9	ms
t_f	V_I shut-down fall time. (From V_I off to 10 % of V_o)	$V_I = 5 \text{ V}$	Max I_o	1.5	ms
			$I_o = 0.1 \text{ A}$	37.5	ms
		$V_I = 12 \text{ V}$	Max I_o	0.9	ms
			$I_o = 0.1 \text{ A}$	41.2	ms
$t_{RC} t_{inh}$	RC start-up time		$V_I = 5 \text{ V}$, Max I_o	6.7	ms
			$V_I = 12 \text{ V}$, Max I_o	6.8	ms
	RC shut-down fall time (From RC off to 10 % of V_o)	$V_I = 5 \text{ V}$	Max I_o	0.8	ms
			$I_o = 0.1 \text{ A}$	38.6	ms
		$V_I = 12 \text{ V}$	Max I_o	0.8	ms
			$I_o = 0.1 \text{ A}$	38.5	ms
I_o	Output current		0	16	A
I_{lim}	Current limit threshold		$T_{ref} < \max T_{ref}$	30	A
I_{sc}	Short circuit current		$T_{ref} = 25^\circ\text{C}$	30	A
V_{Oac}	Output ripple & noise $V_I = 5 \text{ V}$		See ripple & noise section, max I_o	12.9	mVp-p
V_{Oac}	Output ripple & noise $V_I = 12 \text{ V}$		See ripple & noise section, max I_o	21.6	mVp-p

PMP 5000 series PoL Regulators
 Input 4.5 - 14 V, Output up to 16 A / 88 W

1/ 28701- BMR 657 Rev. A November 2017

© Flex

2.5V, 16A / 40.0W Typical Characteristics

PMP 5818UW P

Efficiency

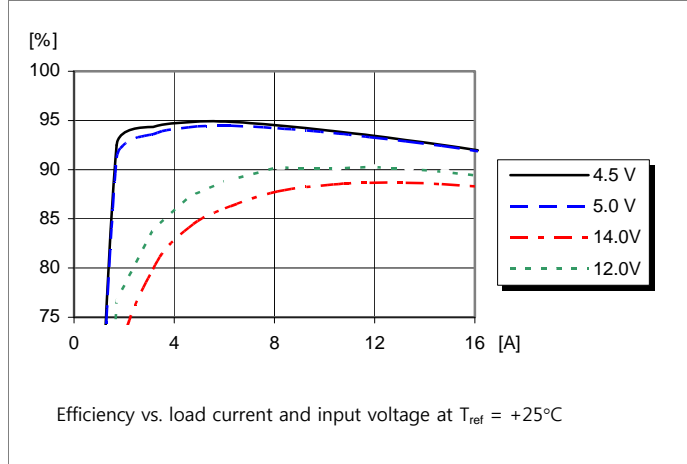

Power Dissipation

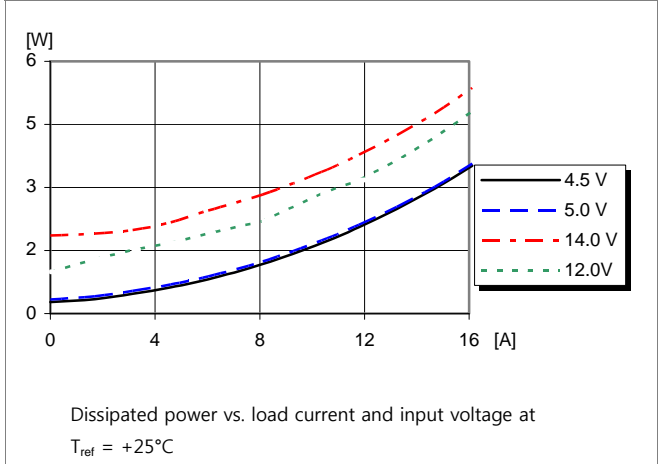

Output Current Derating

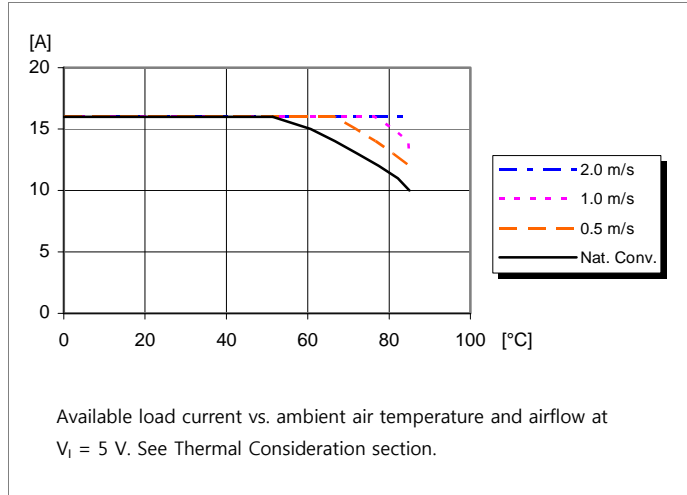

Thermal Resistance

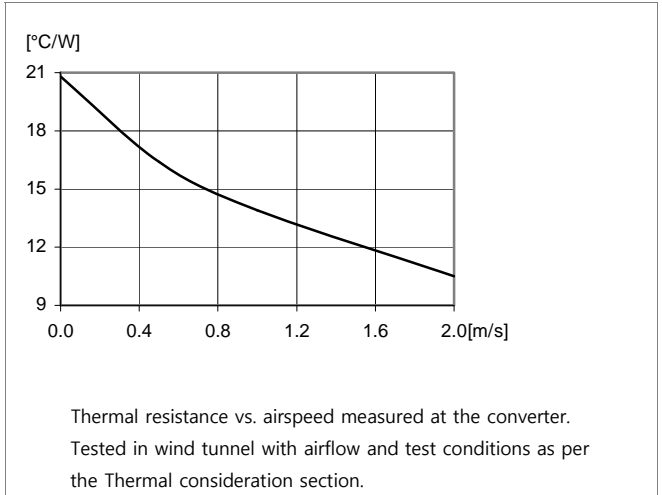

Output Characteristics

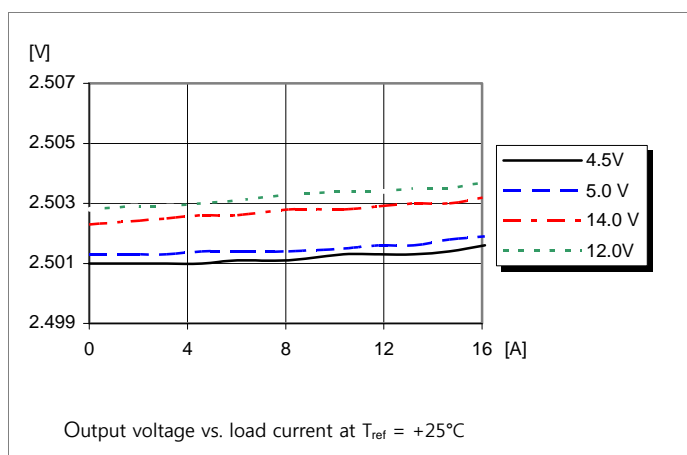

Current Limit Characteristics

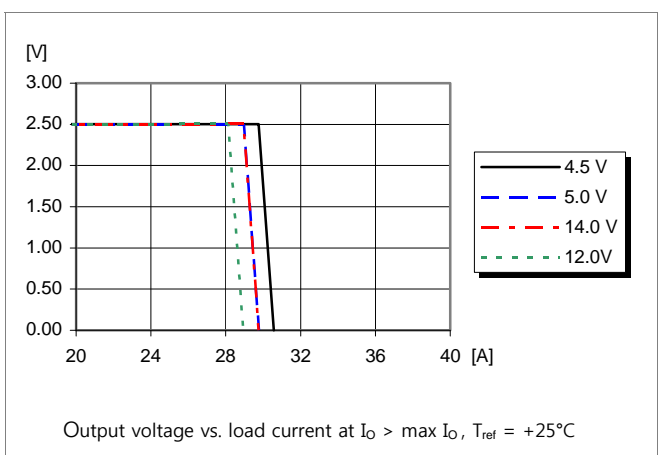

PMP 5000 series PoL Regulators
 Input 4.5 - 14 V, Output up to 16 A / 88 W

1/ 28701- BMR 657 Rev. A November 2017
 © Flex

2.5V, 16A / 40.0W Typical Characteristics $V_I = 5 V$

PMP 5818UW P

Start-up

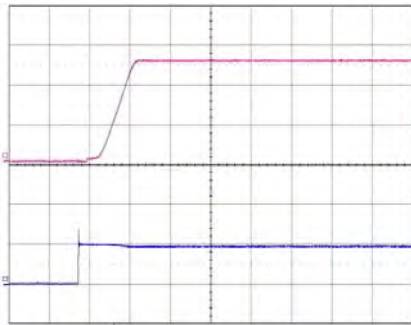

Start-up enabled by connecting V_I at: $T_{ref} = +25^\circ C, V_I = 5 V,$
 Top trace: output voltage (1 V/div).
 Bottom trace: input voltage (5 V/div).

Shut-down

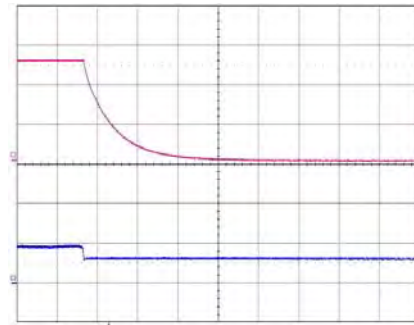

Shut-down enabled by disconnecting V_I at: $T_{ref} = +25^\circ C, V_I = 5 V,$
 Top trace: output voltage (1 V/div).
 Bottom trace: input voltage (5 V/div).

Output Ripple & Noise

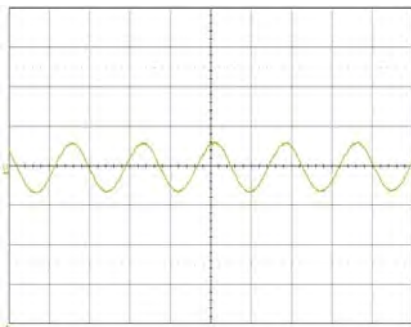

Output voltage ripple at: $T_{ref} = +25^\circ C, V_I = 5 V,$
 $I_O = 16 A$ resistive load.
 Trace: output voltage (10 mV/div).
 Time scale: (2 μs /div).

Output Load Transient Response

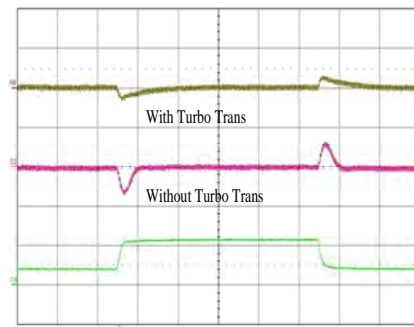

Output voltage response to load current step-change (4-12-4 A) at: $T_{ref} = +25^\circ C, V_I = 5 V.$
 Top trace: output voltage (100 mV/div).
 Middle trace: output voltage (100 mV/div).
 Bottom trace: load current (10 A/div).

Output Voltage Adjust (see operating information)

Passive adjust

The resistor value for an adjusted output voltage is calculated by using the equations in the operating information.

$$R_{SET} = 10k\Omega \times \frac{0.69}{V_o - 0.69} - 1.43k\Omega$$

PMP 5000 series PoL Regulators
 Input 4.5 - 14 V, Output up to 16 A / 88 W

1/ 28701- BMR 657 Rev. A November 2017
 © Flex

2.5V, 16A / 40.0W Typical Characteristics $V_I = 12\text{ V}$

PMP 5818UW P

Start-up

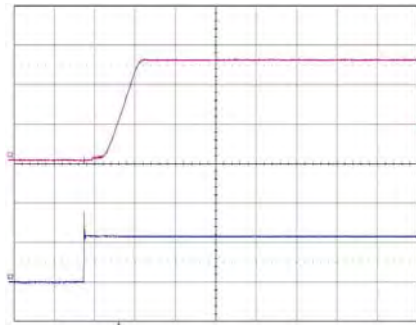

Start-up enabled by connecting V_I at: $T_{ref} = +25^\circ\text{C}$, $V_I = 12\text{ V}$,
 Top trace: output voltage (1 V/div).
 Bottom trace: input voltage (10 V/div).

Shut-down

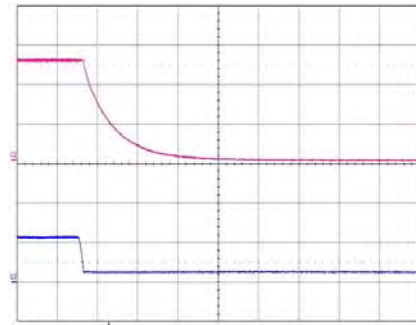

Shut-down enabled by disconnecting V_I at: $T_{ref} = +25^\circ\text{C}$, $V_I = 12\text{ V}$,
 Top trace: output voltage (1 V/div).
 Bottom trace: input voltage (10 V/div).

Output Ripple & Noise

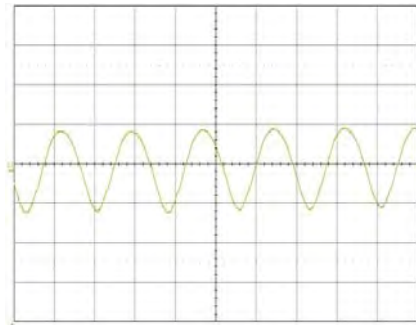

Output voltage ripple at: $T_{ref} = +25^\circ\text{C}$, $V_I = 12\text{ V}$,
 $I_O = 16\text{ A}$ resistive load.
 Trace: output voltage (10 mV/div).
 Time scale: (2 μs /div).

Output Load Transient Response

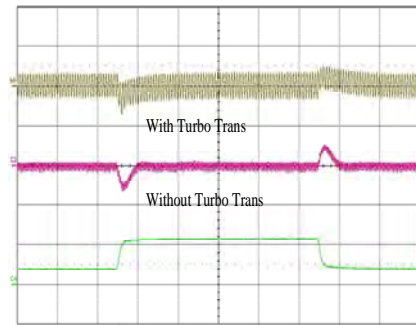

Output voltage response to load current step-change (4-12-4 A) at: $T_{ref} = +25^\circ\text{C}$, $V_I = 12\text{ V}$.
 Top trace: output voltage (100 mV/div).
 Middle trace: output voltage (100 mV/div).
 Bottom trace: load current (10 A/div).

Output Voltage Adjust (see operating information)

Passive adjust

The resistor value for an adjusted output voltage is calculated by using the equations in the operating information.

$$R_{SET} = 10k\Omega \times \frac{0.69}{V_o - 0.69} - 1.43k\Omega$$

PMP 5000 series PoL Regulators Input 4.5 - 14 V, Output up to 16 A / 88 W	1/ 28701- BMR 657 Rev. A November 2017
	© Flex

3.3V, 16A / 52.8W Electrical Specification

PMP 5818UW P

$T_{ref} = -40$ to $+85^{\circ}C$, $V_I = 4.5$ to 14 V, $R_{adj} = 1.21$ k Ω , unless otherwise specified under Conditions.

Typical values given at: $T_{ref} = +25^{\circ}C$, $V_I = 5/12$ V, max I_O , unless otherwise specified under Conditions.

Additional $C_{in} = 330+22$ μF and $C_{out} = 220$ μF . See Operating Information section for selection of capacitor types.

Connect the sense pin, where available, to the output pin.

Characteristics		Conditions	min	typ	max	Unit
V_I	Input voltage range		4.5	5/12	14	V
V_{loff}	Turn-off input voltage	Decreasing input voltage	3.9	4.1		V
V_{lon}	Turn-on input voltage	Increasing input voltage		4.3	4.4	V
C_I	Internal input capacitance			44		μF
P_O	Output power		0		52.8	W
η	Efficiency	$V_I = 5$ V	$V_I = 5$ V, 50 % of max I_O		95.8	%
			$V_I = 5$ V, max I_O		94.0	
		$V_I = 12$ V	$V_I = 12$ V, 50 % of max I_O		91.3	
			$V_I = 12$ V, max I_O		90.8	
P_d	Power Dissipation	$V_I = 5$ V, max I_O		3.4	3.9	W
		$V_I = 12$ V, max I_O		5.4	5.9	W
P_{ii}	Input idling power	$V_I = 5$ V, $I_O = 0$ A		0.31		W
		$V_I = 12$ V, $I_O = 0$ A		1.31		W
P_{RC}	Input standby power	$V_I = 5$ V (turned off with RC)		1.6		mW
		$V_I = 12$ V (turned off with RC)		26.4		mW
I_s	Static Input current	$V_I = 5$ V, max I_O		11.3		A
		$V_I = 12$ V, max I_O		4.9		A
f_s	Switching frequency	0-100 % of max I_O	270	300	330	kHz

V_{oi}	Output voltage initial setting and accuracy	$T_{ref} = +25^{\circ}C$, $V_I = 5/12$ V, max I_O	3.250	3.300	3.350	V
V_O	Output voltage tolerance band	10-100 % of max I_O	3.201		3.399	V
	Idling voltage	$V_I = 5$ V, $I_O = 0$ A		3.304		V
		$V_I = 12$ V, $I_O = 0$ A			3.306	
	Line regulation	max I_O		± 3		mV
Load regulation	$V_I = 5/12$ V, 0-100 % of max I_O		± 2		mV	
V_{tr}	Load transient voltage deviation	$V_I = 5$ V, Load step 25-75-25 % of max I_O , $di/dt = 2.5$ A/ μs		± 75		mV
t_{tr}	Load transient recovery time	Without Turbo Trans $C_o = 1640$ μF Type C		40		μs
V_{tr}	Load transient voltage deviation	$V_I = 5$ V, Load step 25-75-25 % of max I_O , $di/dt = 2.5$ A/ μs		± 40		mV
		With Turbo Trans $C_o = 1640$ μF Type C; $R_{TT} = 2$ k Ω		30		μs
V_{tr}	Load transient voltage deviation	$V_I = 12$ V, Load step 25-75-25 % of max I_O , $di/dt = 2.5$ A/ μs		± 80		mV
		Without Turbo Trans		30		μs

PMP 5000 series PoL Regulators
Input 4.5 - 14 V, Output up to 16 A / 88 W

1/ 28701- BMR 657 Rev. A November 2017

© Flex

			$C_o = 1640 \mu\text{F}$ Type C		
V_{tr}	Load transient voltage deviation		$V_I = 12 \text{ V}$, Load step 25-75-25 % of max I_o , $di/dt = 2.5 \text{ A}/\mu\text{s}$	± 75	mV
t_{tr}	Load transient recovery time		With Turbo Trans $C_o = 1640 \mu\text{F}$ Type C; $R_{TT} = 2 \text{ k}\Omega$	30	μs
t_r	Ramp-up time (from 10–90 % of V_o)		$V_I = 5 \text{ V}$, 100 % of max I_o	3.3	ms
t_s	Start-up time (from V_I connection to 90 % of V_o)			7.0	ms
t_r	Ramp-up time (from 10–90 % of V_o)		$V_I = 12 \text{ V}$, 100 % of max I_o	3.3	ms
t_s	Start-up time (from V_I connection to 90 % of V_o)			6.9	ms
t_f	V_I shut-down fall time. (From V_I off to 10 % of V_o)	$V_I = 5 \text{ V}$	Max I_o	1.2	ms
			$I_o = 0.1 \text{ A}$	50.2	ms
		$V_I = 12 \text{ V}$	Max I_o	1.2	ms
			$I_o = 0.1 \text{ A}$	50.5	ms
$t_{RC} t_{inh}$	RC start-up time		$V_I = 5 \text{ V}$, Max I_o	6.9	ms
			$V_I = 12 \text{ V}$, Max I_o	6.8	ms
	RC shut-down fall time (From RC off to 10 % of V_o)	$V_I = 5 \text{ V}$	Max I_o	1.4	ms
			$I_o = 0.1 \text{ A}$	51.6	ms
		$V_I = 12 \text{ V}$	Max I_o	1.1	ms
			$I_o = 0.1 \text{ A}$	53.9	ms
I_o	Output current		0	16	A
I_{lim}	Current limit threshold		$T_{ref} < \max T_{ref}$	30	A
I_{sc}	Short circuit current		$T_{ref} = 25^\circ\text{C}$	30	A
V_{Oac}	Output ripple & noise $V_I = 5 \text{ V}$		See ripple & noise section, max I_o	11.3	mVp-p
V_{Oac}	Output ripple & noise $V_I = 12 \text{ V}$		See ripple & noise section, max I_o	28.1	mVp-p

PMP 5000 series PoL Regulators
 Input 4.5 - 14 V, Output up to 16 A / 88 W

1/ 28701- BMR 657 Rev. A November 2017
 © Flex

3.3V, 16A / 52.8W Typical Characteristics

PMP 5818UW P

Efficiency

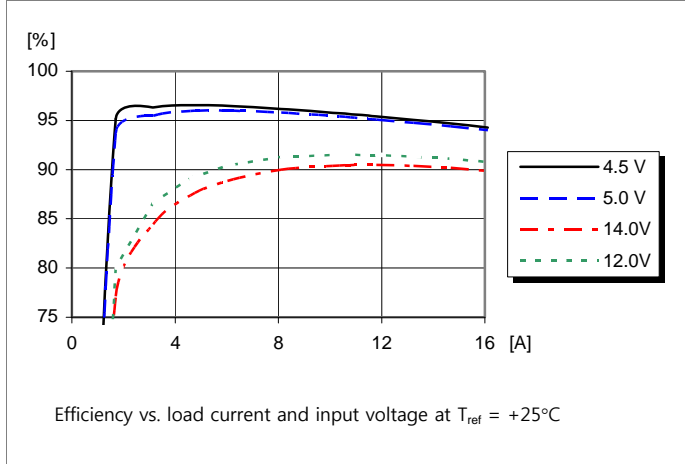

Power Dissipation

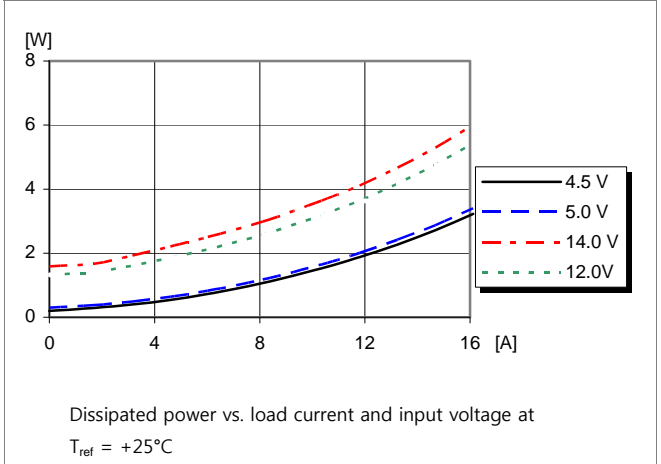

Output Current Derating

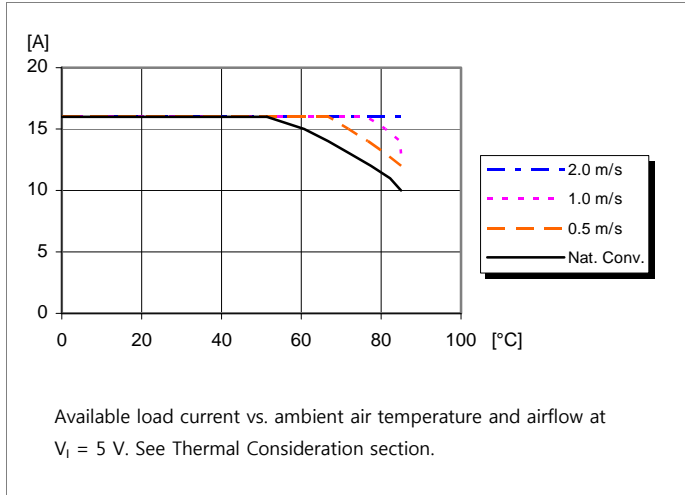

Thermal Resistance

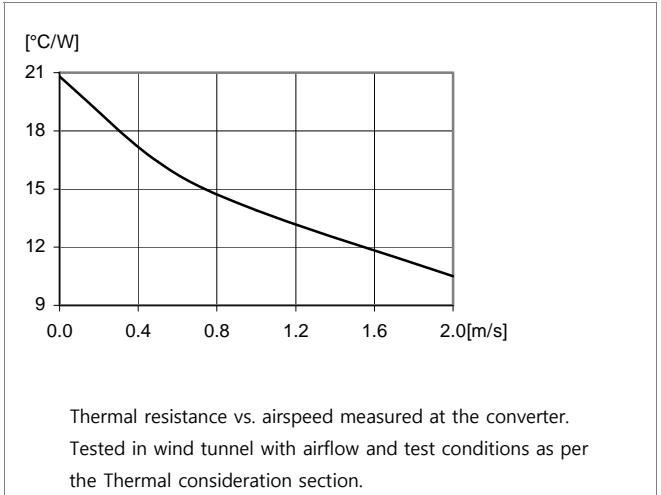

Output Characteristics

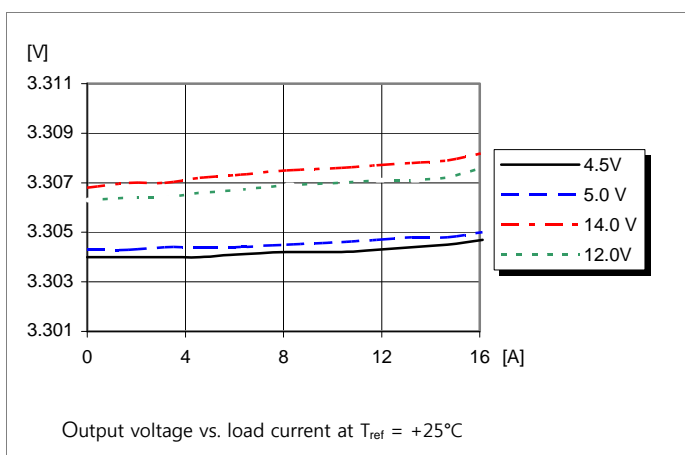

Current Limit Characteristics

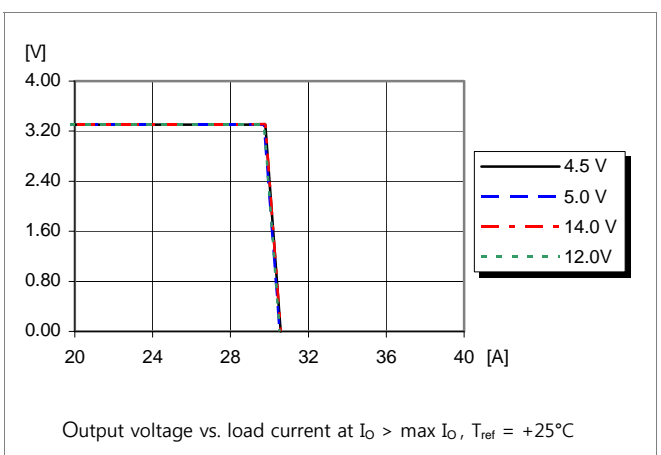

PMP 5000 series PoL Regulators
 Input 4.5 - 14 V, Output up to 16 A / 88 W

1/ 28701- BMR 657 Rev. A November 2017

© Flex

3.3V, 16A / 52.8W Typical Characteristics $V_I = 5\text{ V}$

PMP 5818UW P

Start-up

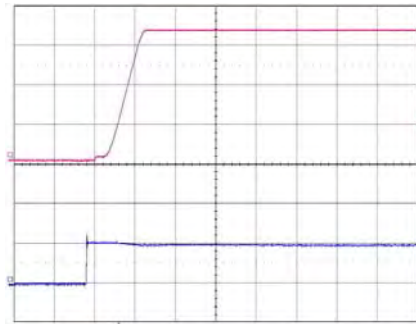

Start-up enabled by connecting V_I at: $T_{ref} = +25^\circ\text{C}$, $V_I = 5\text{ V}$,
 Top trace: output voltage (1 V/div).
 Bottom trace: input voltage (5 V/div).

Shut-down

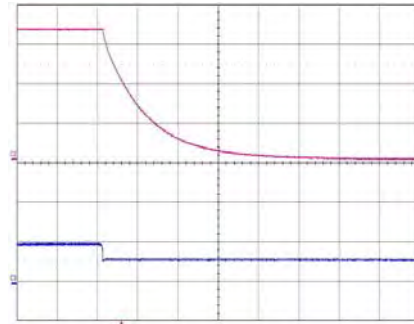

Shut-down enabled by disconnecting V_I at: $T_{ref} = +25^\circ\text{C}$, $V_I = 5\text{ V}$,
 Top trace: output voltage (1 V/div).
 Bottom trace: input voltage (5 V/div).

Output Ripple & Noise

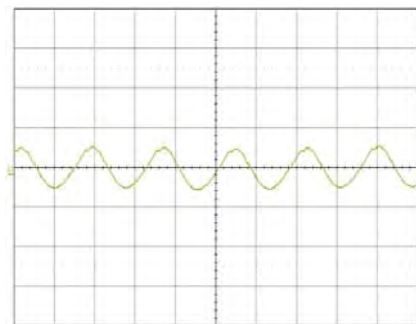

Output voltage ripple at: $T_{ref} = +25^\circ\text{C}$, $V_I = 5\text{ V}$,
 $I_O = 16\text{ A}$ resistive load.
 Trace: output voltage (10 mV/div).
 Time scale: (2 μs /div.).

Output Load Transient Response

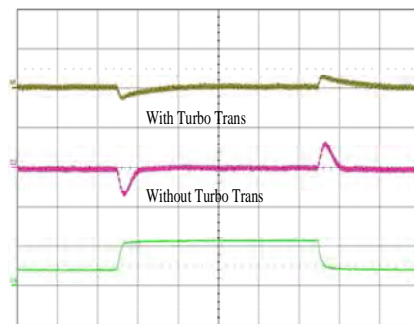

Output voltage response to load current step-change (4-12-4 A) at: $T_{ref} = +25^\circ\text{C}$, $V_I = 5\text{ V}$.
 Top trace: output voltage (100 mV/div).
 Middle trace: output voltage (100 mV/div).
 Bottom trace: load current (10 A/div).

Output Voltage Adjust (see operating information)

Passive adjust

The resistor value for an adjusted output voltage is calculated by using the equations in the operating information.

$$R_{SET} = 10k\Omega \times \frac{0.69}{V_o - 0.69} - 1.43k\Omega$$

PMP 5000 series PoL Regulators
 Input 4.5 - 14 V, Output up to 16 A / 88 W

1/ 28701- BMR 657 Rev. A November 2017
 © Flex

3.3V, 16A / 52.8W Typical Characteristics $V_I = 12\text{ V}$

PMP 5818UW P

Start-up

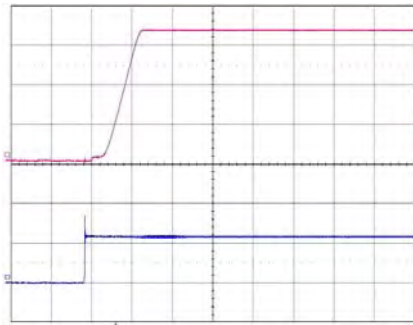

Start-up enabled by connecting V_I at: $T_{ref} = +25^\circ\text{C}$, $V_I = 12\text{ V}$,
 Top trace: output voltage (1 V/div).
 Bottom trace: input voltage (10 V/div).

Shut-down

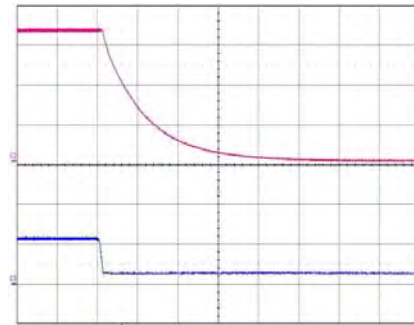

Shut-down enabled by disconnecting V_I at: $T_{ref} = +25^\circ\text{C}$, $V_I = 12\text{ V}$,
 Top trace: output voltage (1 V/div).
 Bottom trace: input voltage (10 V/div).

Output Ripple & Noise

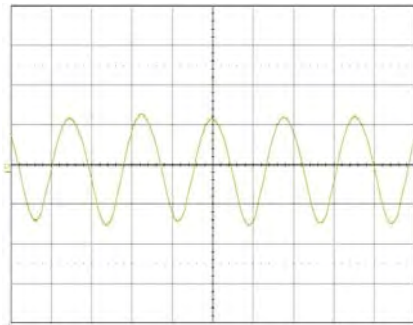

Output voltage ripple at: $T_{ref} = +25^\circ\text{C}$, $V_I = 12\text{ V}$,
 $I_O = 16\text{ A}$ resistive load.
 Trace: output voltage (10 mV/div).
 Time scale: (2 μs /div.).

Output Load Transient Response

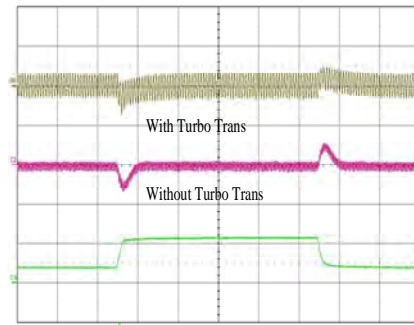

Output voltage response to load current step-change (4-12-4 A) at: $T_{ref} = +25^\circ\text{C}$, $V_I = 12\text{ V}$.
 Top trace: output voltage (100 mV/div).
 Middle trace: output voltage (100 mV/div).
 Bottom trace: load current (10 A/div.).

Output Voltage Adjust (see operating information)

Passive adjust

The resistor value for an adjusted output voltage is calculated by using the equations in the operating information.

$$R_{SET} = 10k\Omega \times \frac{0.69}{V_o - 0.69} - 1.43k\Omega$$

PMP 5000 series PoL Regulators
 Input 4.5 - 14 V, Output up to 16 A / 88 W

1/ 28701- BMR 657 Rev. A November 2017

© Flex

5.0V, 16A / 80.0W Electrical Specification
PMP 5818UW P
 $T_{ref} = -40$ to $+85^{\circ}\text{C}$, $V_I = 7$ to 14 V, $R_{adj} = 171 \Omega$, unless otherwise specified under Conditions.

 Typical values given at: $T_{ref} = +25^{\circ}\text{C}$, $V_I = 12$ V, max I_O , unless otherwise specified under Conditions.

 Additional $C_{in} = 330+22 \mu\text{F}$ and $C_{out} = 220 \mu\text{F}$. See Operating Information section for selection of capacitor types.

Connect the sense pin, where available, to the output pin.

Characteristics		Conditions	min	typ	max	Unit
V_I	Input voltage range		7	12	14	V
V_{loff}	Turn-off input voltage	Decreasing input voltage	4.5	4.7		V
V_{lon}	Turn-on input voltage	Increasing input voltage		4.8	5.0	V
C_I	Internal input capacitance			44		μF
P_O	Output power		0		80	W
η	Efficiency	50 % of max I_O		92.8		%
		max I_O		92.6		
P_d	Power Dissipation	max I_O		6.5	7.0	W
P_{li}	Input idling power	$I_O = 0$ A, $V_I = 12$ V		1.8		W
P_{RC}	Input standby power	$V_I = 12$ V (turned off with RC)		33.9		mW
I_S	Static Input current	$V_I = 12$ V, max I_O		7.3		A
f_s	Switching frequency	0-100 % of max I_O	270	300	330	kHz

V_{oi}	Output voltage initial setting and accuracy	$T_{ref} = +25^{\circ}\text{C}$, $V_I = 12$ V, max I_O	4.925	5.000	5.075	V
V_O	Output voltage tolerance band	10-100 % of max I_O	4.850		5.150	V
	Idling voltage	$I_O = 0$ A		5.004		V
	Line regulation	max I_O		± 3		mV
	Load regulation	$V_I = 12$ V, 0-100 % of max I_O		± 2		mV
V_{tr}	Load transient voltage deviation	$V_I = 12$ V, Load step 25-75-25 % of max I_O , $di/dt = 2.5$ A/ μs		± 80		mV
t_{tr}	Load transient recovery time	Without Turbo Trans $C_o = 1640 \mu\text{F}$ Type C		40		μs
V_{tr}	Load transient voltage deviation	$V_I = 12$ V, Load step 25-75-25 % of max I_O , $di/dt = 2.5$ A/ μs		± 70		mV
t_{tr}	Load transient recovery time	With Turbo Trans $C_o = 1640 \mu\text{F}$ Type C; $R_{TT} = 2$ k Ω		30		μs
t_r	Ramp-up time (from 10–90 % of V_{oi})	100 % of max I_O		3.0		ms
t_s	Start-up time (from V_I connection to 90 % of V_{oi})			7.0		ms
t_f	V_I shut-down fall time. (From V_I off to 10 % of V_O)	Max I_O		1.6		ms
		$I_O = 0.1$ A		78.3		ms
t_{RC} t_{inh}	RC start-up time	Max I_O		7.0		ms
	RC shut-down fall time (From RC off to 10 % of V_O)	Max I_O		0.7		ms
		$I_O = 0.1$ A		81.2		ms
I_O	Output current		0		16	A

PMP 5000 series PoL Regulators
 Input 4.5 - 14 V, Output up to 16 A / 88 W

1/ 28701- BMR 657 Rev. A November 2017

© Flex

I_{lim}	Current limit threshold	$T_{ref} < \max T_{ref}$	29	A
I_{sc}	Short circuit current	$T_{ref} = 25^{\circ}\text{C}$	29	A
V_{Oac}	Output ripple & noise	See ripple & noise section, $\max I_O$	40.2	mVp-p

PMP 5000 series PoL Regulators
 Input 4.5 - 14 V, Output up to 16 A / 88 W

1/ 28701- BMR 657 Rev. A November 2017

© Flex

5.0V, 16A / 80.0W Typical Characteristics

PMP 5818UW P

Efficiency

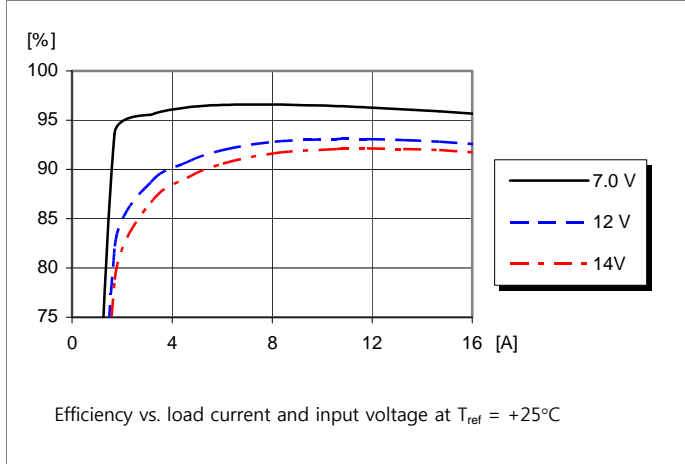

Power Dissipation

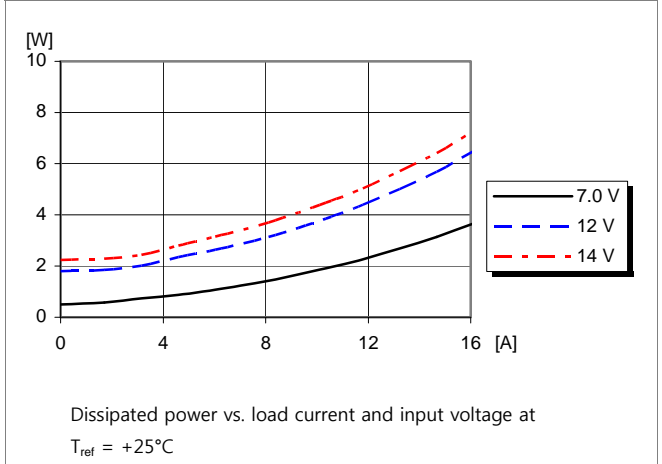

Output Current Derating

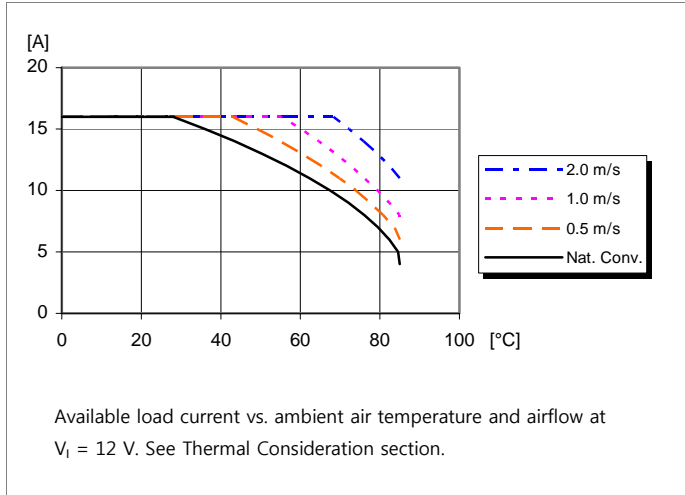

Thermal Resistance

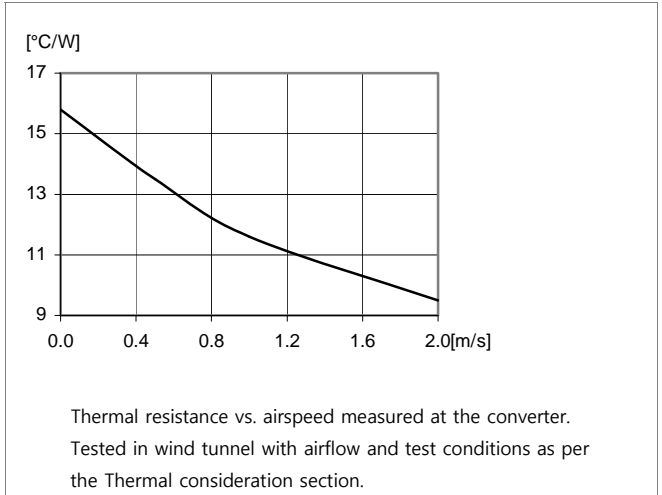

Output Characteristics

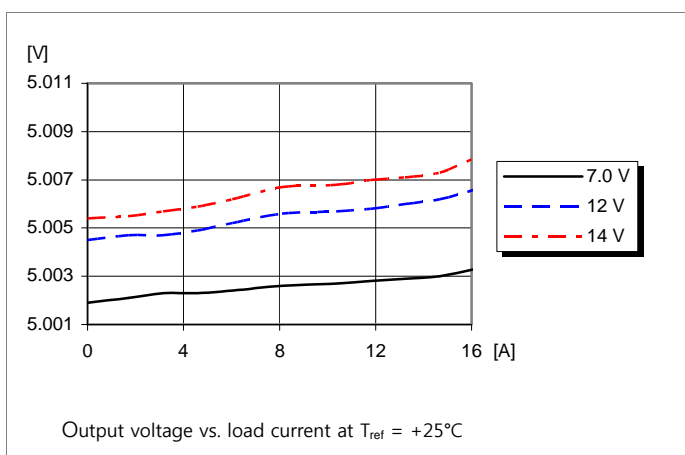

Current Limit Characteristics

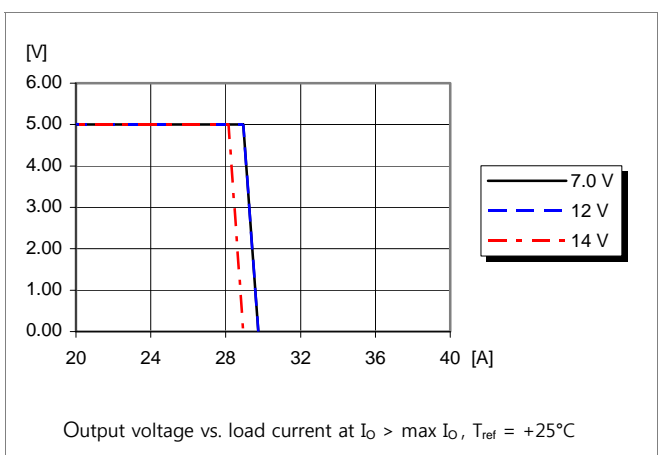

PMP 5000 series PoL Regulators
 Input 4.5 - 14 V, Output up to 16 A / 88 W

1/ 28701- BMR 657 Rev. A November 2017

© Flex

5.0V, 16A / 80.0W Typical Characteristics

PMP 5818UW P

Start-up

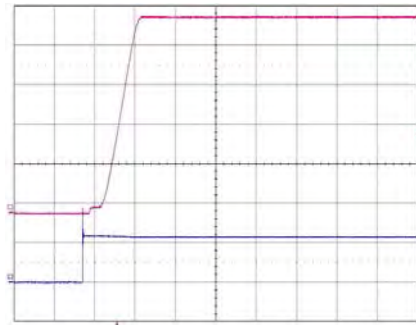

Start-up enabled by connecting V_I at: $T_{ref} = +25^\circ\text{C}$, $V_I = 12\text{ V}$,
 Top trace: output voltage (1 V/div.).
 Bottom trace: input voltage (10 V/div.).

Shut-down

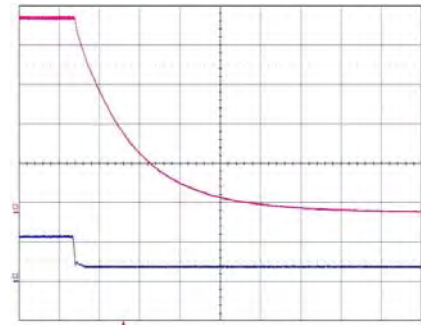

Shut-down enabled by disconnecting V_I at: $T_{ref} = +25^\circ\text{C}$, $V_I = 12\text{ V}$,
 Top trace: output voltage (1 V/div.).
 Bottom trace: input voltage (10 V/div.).

Output Ripple & Noise

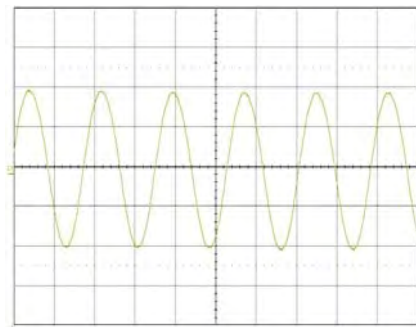

Output voltage ripple at: $T_{ref} = +25^\circ\text{C}$, $V_I = 12\text{ V}$,
 $I_O = 16\text{ A}$ resistive load.
 Trace: output voltage (10 mV/div.).
 Time scale: (2 μs /div.).

Output Load Transient Response

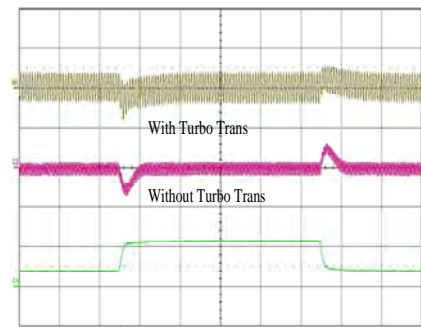

Output voltage response to load current step-change (4-12-4 A) at: $T_{ref} = +25^\circ\text{C}$, $V_I = 12\text{ V}$.
 Top trace: output voltage (100 mV/div.).
 Middle trace: output voltage (100 mV/div.).
 Bottom trace: load current (10 A/div.).

Output Voltage Adjust (see operating information)

Passive adjust

The resistor value for an adjusted output voltage is calculated by using the equations in the operating information.

$$R_{SET} = 10k\Omega \times \frac{0.69}{V_o - 0.69} - 1.43k\Omega$$

PMP 5000 series PoL Regulators
 Input 4.5 - 14 V, Output up to 16 A / 88 W

1/ 28701- BMR 657 Rev. A November 2017
 © Flex

EMC Specification

Conducted EMI measured according to test set-up.
 The fundamental switching frequency is 300 kHz for
 PMP 5818UW P @ $V_i = 5/12$ V, max I_o .

Conducted EMI Input terminal value (typ)

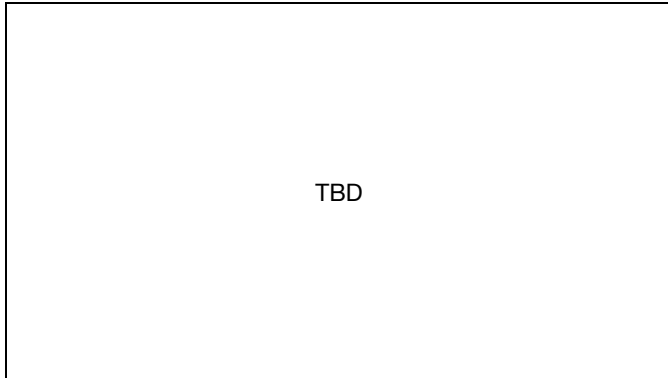

EMI without filter

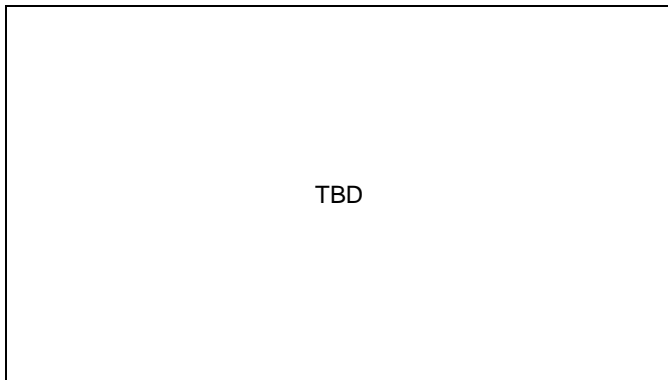

Test set-up

Layout recommendation

The radiated EMI performance of the DC/DC regulator will depend on the PCB layout and ground layer design. It is also important to consider the stand-off of the DC/DC regulator. If a ground layer is used, it should be connected to the output of the DC/DC regulator and the equipment ground or chassis.

A ground layer will increase the stray capacitance in the PCB and improve the high frequency EMC performance.

Output ripple and noise

Output ripple and noise measured according to figure below. See Design Note 022 for detailed information.

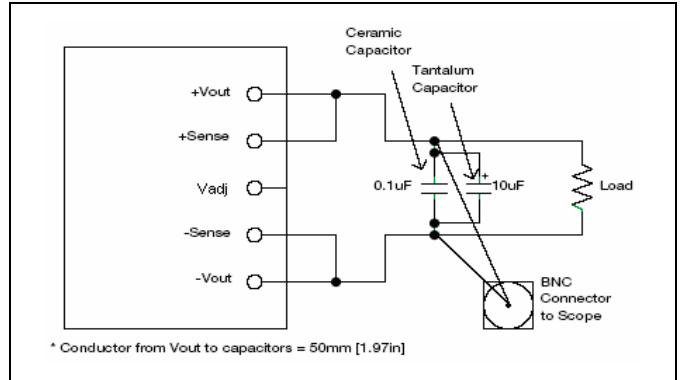

Output ripple and noise test setup

Operating information

Extended information for POLA products is found in Application Note 205.

Input Voltage

The input voltage range 4.5 to 14 Vdc makes the product easy to use in intermediate bus applications when powered by a regulated bus converter.

Turn-off Input Voltage

The DC/DC regulators monitor the input voltage and will turn on and turn off at predetermined levels. The minimum hysteresis between turn on and turn off input voltage is 0.1V.

Remote Control (RC) Inhibit

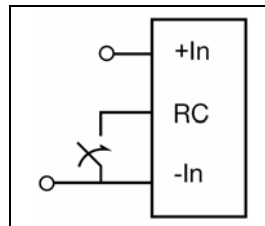

The products are fitted with a remote control function referenced to positive logic. The RC function allows the regulator to be turned on/off by an external device like a semiconductor or mechanical switch. The RC pin has an internal pull up resistor to + In.

The maximum required sink current is 1 mA. When the RC pin is left open, the voltage generated on the RC pin is 4.5 - 14 V. The regulator will turn on when the input voltage is applied with the RC pin open. Turn off is achieved by connecting the RC pin to the - In. To ensure safe turn off the voltage difference between RC pin and the - In pin shall be less than 1V. The regulator will restart automatically when this connection is opened.

PMP 5000 series PoL Regulators

Input 4.5 - 14 V, Output up to 16 A / 88 W

1/ 28701- BMR 657 Rev. A November 2017

© Flex

External Capacitors

Input capacitors:

The PMP 5818UW P requires a combination of one 22 μF X5R/X7R ceramic and 330 μF electrolytic type. The ripple current rating of the electrolytic capacitor must be at least 950 mA rms. The ripple current rating must increase to 1500 mA rms when $V_o > 2.1\text{V}$ and $I_o \geq 11\text{A}$.

If using the ceramic capacitor as the input capacitor, the PMP 5818UW P needs a minimum input capacitance of 300 μF . In addition, output capacitor also need ceramic capacitor, PMP 5818UW P needs a minimum output capacitance of 300 μF .

For high-performance/transient application, or wherever the input source performance is degraded, 680 μF of input capacitance is recommended. The additional input capacitance above the minimum level insures an optimized performance.

Output capacitors:

The PMP 5818UW P requires a minimum output capacitance of 220 μF of aluminium, polymer-aluminium, tantalum, or polymer-tantalum type.

The required capacitance above the minimum will be determined by actual transient deviation requirements.

When using one or more non-ceramic capacitors, the calculated equivalent ESR should be no lower than 4 $\text{m}\Omega$ (7 $\text{m}\Omega$ using the manufacturer's maximum ESR for a single capacitor).

Turbo Trans™ allows the designer to optimize the capacitance load according to the system transient design requirement. High quality, ultra-low ESR capacitors are required to maximize Turbo Trans™ effectiveness. Capacitors with a capacitance (μF) \times ESR ($\text{m}\Omega$) $\leq 10,000 \text{ m}\Omega \times \mu\text{F}$ are required.

Required Capacitor with Turbo Trans. See the Turbo Trans™ Application information for Capacitor Selection. Capacitor Type Group by ESR (Equivalent Series Resistance)

Type A = ($100 < \text{capacitance} \times \text{ESR} \leq 1,000$)

Type B = ($1,000 < \text{capacitance} \times \text{ESR} \leq 5,000$)

Type C = ($5,000 < \text{capacitance} \times \text{ESR} \leq 10,000$)

Input And Output Impedance

The impedance of both the input source and the load will interact with the impedance of the DC/DC regulator. It is important that the input source has low characteristic impedance. The regulators are designed for stable operation without external capacitors connected to the input or output. The performance in some applications can be enhanced by addition of external capacitance as described under External Decoupling Capacitors. If the input voltage source contains significant inductance, the addition of a 100 μF capacitor

across the input of the regulator will ensure stable operation. The capacitor is not required when powering the DC/DC regulator from an input source with an inductance below 10 μH .

External Decoupling Capacitors

When powering loads with significant dynamic current requirements, the voltage regulation at the point of load can be improved by addition of decoupling capacitors at the load. The most effective technique is to locate low ESR ceramic and electrolytic capacitors as close to the load as possible, using several parallel capacitors to lower the effective ESR. The ceramic capacitors will handle high-frequency dynamic load changes while the electrolytic capacitors are used to handle low frequency dynamic load changes. Ceramic capacitors will also reduce any high frequency noise at the load.

It is equally important to use low resistance and low inductance PCB layouts and cabling.

External decoupling capacitors will become part of the control loop of the DC/DC regulator and may affect the stability margins. As a "rule of thumb", 100 $\mu\text{F}/\text{A}$ of output current can be added without any additional analysis. The ESR of the capacitors is a very important parameter. Power Modules guarantee stable operation with a verified ESR value of $>10 \text{ m}\Omega$ across the output connections. For further information please contact your local Flex representative.

Output Voltage Adjust (V_{adj})

The DC/DC regulators have an Output Voltage Adjust pin (V_{adj}). This pin can be used to adjust the output voltage above or below Output voltage initial setting.

To increase or decrease the voltage, the resistor should be connected between the V_{adj} pin and GND pin. The resistor value of the output voltage adjust function is according to information given under the output section for the respective product.

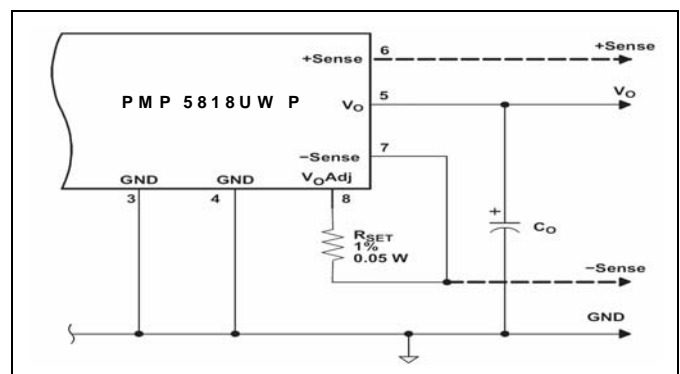

Parallel Operation

Two regulators may be paralleled for redundancy if the total power is equal or less than $P_o \text{ max}$. It is not recommended to parallel the regulators without using external current sharing

PMP 5000 series PoL Regulators
Input 4.5 - 14 V, Output up to 16 A / 88 W

1/ 28701- BMR 657 Rev. A November 2017
© Flex

circuits.

Remote Sense

The DC/DC regulators have remote sense that can be used to compensate for voltage drops between the output and the point of load. The sense traces should be located close to the PCB ground layer to reduce noise susceptibility. The remote sense circuitry will compensate for up to 10% voltage drop between output pins and the point of load.

If the remote sense is not needed +Sense should be connected to +Out and -Sense should be connected to -Out.

Over Temperature Protection (OTP)

The regulators are protected from thermal overload by an internal over temperature shutdown circuit. When T_{ref} as defined in thermal consideration section exceeds the OTP threshold, the regulator will shut down. The DC/DC regulator will make continuous attempts to start up (non-latching mode) and resume normal operation automatically when the temperature has dropped $>10^{\circ}C$ below the temperature threshold.

Over Current Protection (OCP)

The regulators include current limiting circuitry for protection at continuous overload. The output voltage will decrease towards zero for output currents in excess of max output current (max I_o). The regulator will resume normal operation after removal of the overload. The load distribution should be designed for the maximum output short circuit current specified.

Soft-start Power Up

From the moment a valid input voltage is applied, the soft-start control introduces a short time-delay (typically 5-10 ms) before allowing the output voltage to rise. The initial rise in input current when the input voltage first starts to rise is the charge current drawn by the input capacitors. Power-up is complete within 15 ms.

Auto Track™ Function

Auto Track™ was designed to simplify the amount of circuitry required to make the output voltage from each module power up and power down in sequence. The sequencing of two or more supply voltages during power up is a common requirement for complex mixed-signal applications, that use dual-voltage VLSI ICs such as DSPs, micro-processors and ASICs.

Adjustable Undervoltage Lockout

The regulators incorporate an input undervoltage lockout (UVLO). The UVLO feature prevents the operation of the module until there is a sufficient input voltage to produce a valid output voltage. This enables the module to provide a clean, monotonic powerup for the load circuit and also limit the magnitude of current drawn from regulator's input source during the power-up sequence.

The UVLO characteristic is defined by the ON threshold (V_{THD}) voltage. Below the ON threshold, the Inhibit control is overridden, and the module does not produce an output. The hysteresis voltage, which is the difference between the ON and OFF threshold voltage, is set at 500 mV. The hysteresis prevents start up oscillations, which can occur if the input voltage drops slightly when the modules begins to draw current from the input source.

The UVLO feature of the PMP 5818UW P module allows for limited adjustment of the ON threshold voltage. The adjustment is made via the Inhibit/UVLO Prog control pin (Pin 11) using a single resistor (see figure below). When pin 11 is left open, the ON threshold voltage is internally set to its default value, which is 4.3 volts. The ON threshold might need to be raised if the module is powered from a tightly regulated 12 V bus. Adjusting the threshold voltage prevents the module from operating if the input bus fails to completely rise to its specified regulation voltage.

The below equation determines the value of R_{UVLO} required to adjust V_{THD} to a new value. The default value is 4.3 V and it may only be adjusted to a higher value.

$$R_{UVLO} = \frac{9690 - (137 \times V_{THD})}{137 \times V_{THD} - 585} (k\Omega)$$

Standard R_{UVLO} values for Various V_{THD} values

V_{THD}	5.0 V	5.5 V	6.0 V	6.5 V	7.0 V	7.5 V	8.0 V	8.5 V	9.0 V	9.5 V	10.0 V	10.5 V	11.0 V
R_{UVLO}	88.7 k Ω	52.3 k Ω	37.4 k Ω	28.7 k Ω	23.2 k Ω	19.6 k Ω	16.9 k Ω	14.7 k Ω	13.0 k Ω	11.8 k Ω	10.5 k Ω	9.76 k Ω	8.87 k Ω

The above table lists the standard resistor values for R_{UVLO} for different values of the ON threshold (V_{THD}) voltage. The figure of UVLO Program Resistor Placement is as follow.

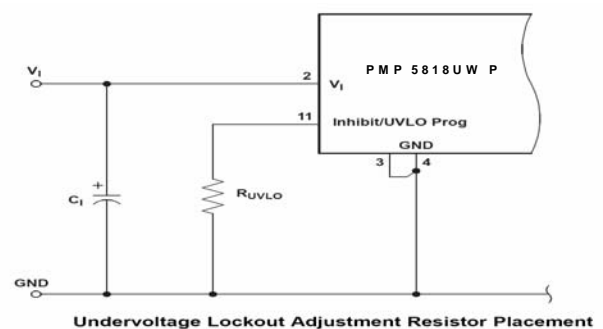

Turbo Trans™ Technology

Turbo Trans™ optimizes the transient response of the regulator with added external capacitance using a single external resistor. The benefits of this technology include: reduced output capacitance, minimized output voltage deviation following a load transient, and enhanced stability when using ultra-low ESR output capacitors. The amount of output capacitance required to meet a target output voltage deviation, is reduced with Turbo Trans™ activated. Likewise,

PMP 5000 series PoL Regulators
Input 4.5 - 14 V, Output up to 16 A / 88 W

1/ 28701- BMR 657 Rev. A November 2017
© Flex

for a given amount of output capacitance, with Turbo Trans engaged, the amplitude of the voltage deviation following a load transient is reduced. Applications requiring tight transient voltage tolerances and minimized capacitor footprint area benefit from this technology.

Utilizing Turbo Trans™ requires connecting a resistor, R_{TT} , between the +Sense pin (pin 6) and the Turbo Trans pin (pin 9). The value of the resistor directly corresponds to the amount of output capacitance required. For the PMP 5818UW P, the minimum required capacitance is 2200 μF . When using Turbo Trans™, capacitors with a capacitance \times ESR product below 10,000 $\mu\text{F}\times\text{m}\Omega$ are required.

To see the benefit of Turbo Trans™, follow the 5mV/A marking across to the “Without Turbo Trans™” plot. Following that point down shows that more than 4,500 μF of output capacitance is required to meet the same transient deviation limit. This is the benefit of Turbo Trans™. A typical Turbo Trans™ application schematic is also shown.

Type A TurboTrans C_o Values and Required R_{TT} Selection Table

Transient Voltage Deviation (mV)			12 Volt Input		5 Volt Input	
25% load step (4 A)	50% load step (8 A)	75% load step (12 A)	C_o Minimum Required Output Capacitance (μF)	R_{TT} Required TurboTrans Resistor (k Ω)	C_o Minimum Required Output Capacitance (μF)	R_{TT} Required TurboTrans Resistor (k Ω)
75	150	225	300	open	300	open
65	130	195	420	78.7	430	68.1
55	110	165	530	33.2	550	30.9
50	100	150	700	15.4	730	13.7
45	90	135	835	10.0	870	8.87
40	80	120	1000	5.76	1050	4.87
35	70	105	1250	2.10	1300	1.62
30	60	90	1730	short	4200	short

R_{TT} Resistor Selection

The Turbo Trans™ resistor value, R_{TT} can be determined from the Turbo Trans™ programming equation, see the equation below.

$$R_{TT} = 40 \times \frac{1 - \left(\frac{C_o}{1500}\right)}{5 \times \left(\frac{C_o}{1500}\right) - 1} \text{ (k}\Omega\text{)}$$

Where C_o is the total output capacitance in μF . C_o values greater than or equal to 1500 μF require R_{TT} to be a short, 0 Ω . To ensure stability, a minimum amount of output capacitance is required for a given R_{TT} resistor value. The value of R_{TT} must be calculated using the minimum required output capacitance.

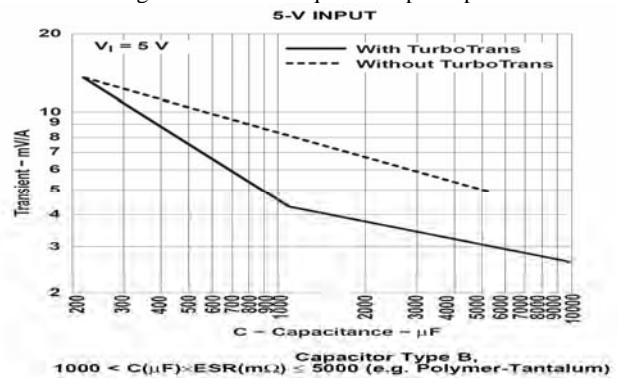
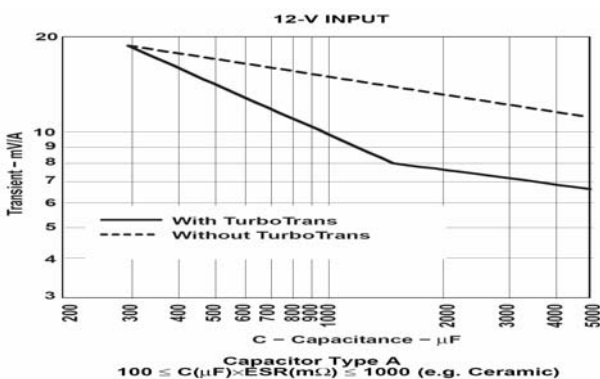
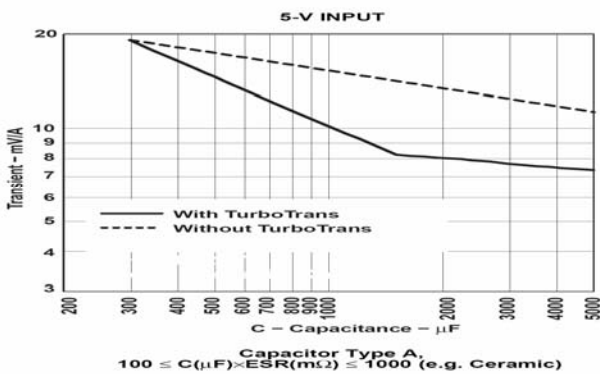

PMP 5000 series PoL Regulators
 Input 4.5 - 14 V, Output up to 16 A / 88 W

1/ 28701- BMR 657 Rev. A November 2017
 © Flex

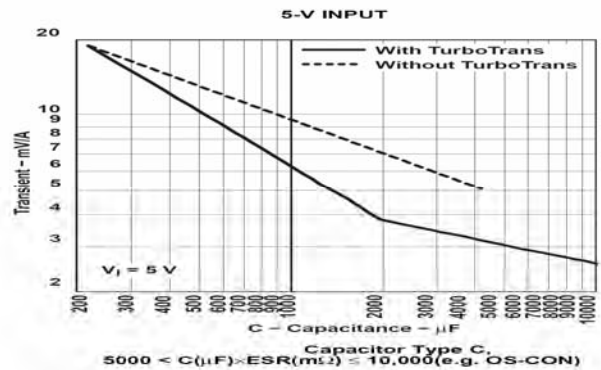
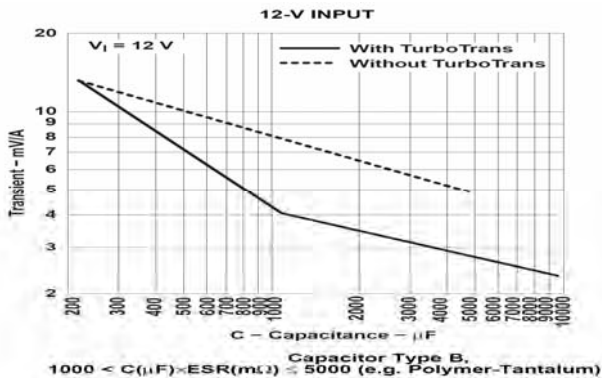

Type B TurboTrans C₀ Values and Required R_{TT} Selection Table

Transient Voltage Deviation (mV)			12 Volt Input		5 Volt Input	
25% load step (4 A)	50% load step (8 A)	75% load step (12 A)	C ₀ Minimum Required Output Capacitance (μF)	R _{TT} Required TurboTrans Resistor (kΩ)	C ₀ Minimum Required Output Capacitance (μF)	R _{TT} Required TurboTrans Resistor (kΩ)
65	125	190	220	open	220	open
50	100	150	270	132	270	132
40	80	120	330	56	330	56
30	60	90	470	20.5	500	17.4
25	50	75	600	10.5	650	8.25
20	40	60	800	4.12	900	2.32
15	30	45	1500	short	1700	short
10	20	30	7000	short	10000	short

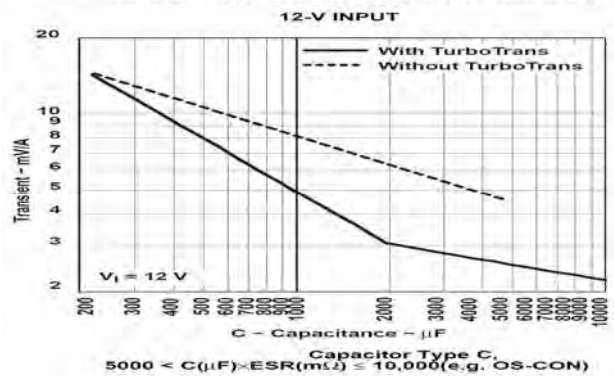

Type C TurboTrans C₀ Values and Required R_{TT} Selection Table

Transient Voltage Deviation (mV)			12 Volt Input		5 Volt Input	
25% Load Step (4 A)	50% Load Step (8 A)	75% Load Step (12 A)	C ₀ Minimum Required Output Capacitance (μF)	R _{TT} Required TurboTrans Resistor (kΩ)	C ₀ Minimum Required Output Capacitance (μF)	R _{TT} Required TurboTrans Resistor (kΩ)
65	125	190	220	open	220	open
50	100	150	270	274	330	121
40	80	120	330	121	550	34.8
30	60	90	470	48.7	630	26.1
25	50	75	600	28.7	800	16.2
20	40	60	800	16.2	1150	7.15
15	30	45	1300	5.11	1700	1.50
10	20	30	7500	short	10000	short

R_{TT} Resistor Selection

The Turbo Trans™ resistor value, R_{TT} can be determined from the Turbo Trans™ programming equation, see the equation below.

$$R_{TT} = 40 \times \frac{1 - \left(\frac{C_o}{1100}\right)}{5 \times \left(\frac{C_o}{1100}\right) - 1} (k\Omega)$$

Where C₀ is the total output capacitance in μF. C₀ values greater than or equal to 1100 μF require R_{TT} to be a short, 0Ω. To ensure stability, a minimum amount of output capacitance is required for a given R_{TT} resistor value. The value of R_{TT} must be calculated using the minimum required output capacitance.

R_{TT} Resistor Selection

The Turbo Trans resistor value, R_{TT} can be determined from the Turbo Trans™ programming equation, see the equation below.

$$R_{TT} = 40 \times \frac{1 - \left(\frac{C_o}{1980}\right)}{\left(\frac{5 \times C_o + 880}{1980}\right) - 1} (k\Omega)$$

Where C₀ is the total output capacitance in μF. C₀ values greater than or equal to 1980 μF require R_{TT} to be a short, 0Ω. To ensure stability, a minimum amount of output capacitance is required for a given R_{TT} resistor value. The value of R_{TT} must be calculated using the minimum required output capacitance.

PMP 5000 series PoL Regulators
 Input 4.5 - 14 V, Output up to 16 A / 88 W

1/ 28701- BMR 657 Rev. A November 2017
 © Flex

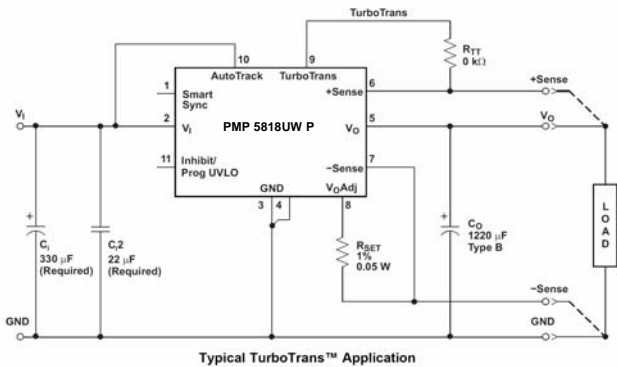

output voltage and switching frequency. Operationally, the maximum input voltage is inversely proportional to switching frequency. Synchronizing to a higher frequency causes greater restrictions on the input voltage range. For a given switching frequency, the below figure shows how the maximum input voltage varies with output voltage.

For example, for a module operating at 400 KHz and an output voltage of 1.2 V, the maximum input voltage is 10 V. Exceeding the maximum input voltage may cause in an increase in output ripple voltage and increased output voltage variation.

As shown in the below figure, input voltage below 6 V can operate down to the minimum output voltage over the entire synchronization frequency range.

Smart Sync

Smart Sync is a feature that allows multiple power modules to be synchronized to a common frequency. Driving the Smart Sync pins with an external oscillator set to the desired frequency, synchronizes all connected modules to the selected frequency. The synchronization frequency can be higher or lower than the nominal switching frequency of the modules within the range of 240 KHz to 400 KHz. Synchronizing modules powered from the same bus eliminates beat frequencies reflected back to the input supply, and also reduces EMI filtering requirements. Eliminating the slow beat frequencies (usually < 10 KHz) allows the EMI filter to be designed to attenuate only the synchronization frequency. Power modules can also be synchronized out of phase to minimize ripple current and reduce input capacitance requirements. The below figure shows a standard circuit with two modules synchronized 180° out of phase using a D flip-flop.

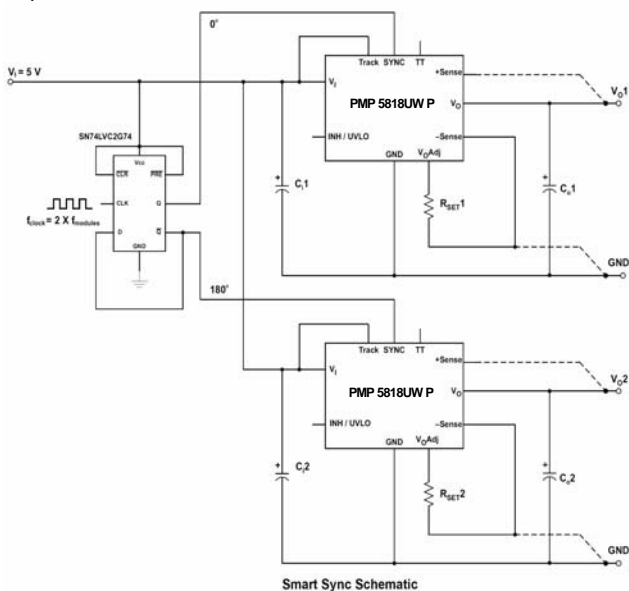
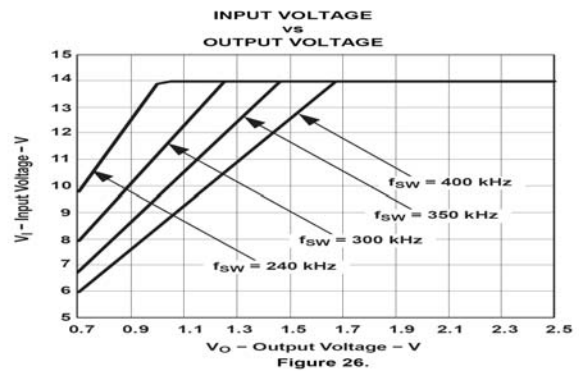

The maximum input voltage allowed for proper synchronization is duty cycle limited. When using Smart Sync, the maximum allowable input voltage varies as a function of

PMP 5000 series PoL Regulators
 Input 4.5 - 14 V, Output up to 16 A / 88 W

1/ 28701- BMR 657 Rev. A November 2017
 © Flex

Thermal Consideration

General

The regulators are designed to operate in different thermal environments and sufficient cooling must be provided to ensure reliable operation.

Cooling is achieved mainly by conduction, from the pins to the host board, and convection, which is dependant on the airflow across the regulator. Increased airflow enhances the cooling of the regulator.

The Output Current Derating graph found in the Output section for each model provides the available output current vs. ambient air temperature and air velocity at $V_{in} = 5/12$ V.

The DC/DC regulator is tested on a 10.2 x 10.2 mm, 35 μ m (1 oz), 4-layer test board mounted vertically in a wind tunnel with a cross-section of 305 x 305 mm.

Proper cooling of the DC/DC regulator can be verified by measuring the temperature at positions P1, P2 and P3. The temperature at these positions should not exceed the max values provided in the table below.

Note that the max value is the absolute maximum rating (non destruction) and that the electrical Output data is guaranteed up to ambient temperature +85°C.

See Design Note 019 for further information.

Position	Device	Designation	max value
P ₁	Pcb		130° C
P ₂	Mosfet		130° C
P ₃	Inductor	T _{ref}	130° C

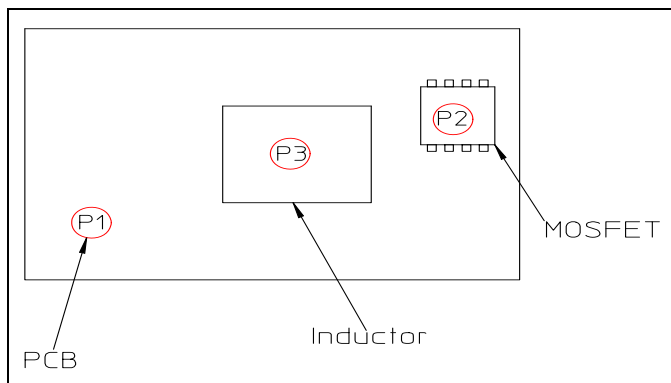

PMP 5000 series PoL Regulators
 Input 4.5 - 14 V, Output up to 16 A / 88 W

1/ 28701- BMR 657 Rev. A November 2017
 © Flex

Thermal Consideration continued

Definition of reference temperature (T_{ref})

The reference temperature is used to monitor the temperature limits of the product. Temperatures above maximum T_{ref} are not allowed and may cause degradation or permanent damage to the product. T_{ref} is also used to define the temperature range for normal operating conditions. T_{ref} is defined by the design and used to guarantee safety margins, proper operation and high reliability of the module.

Ambient Temperature Calculation

By using the thermal resistance the maximum allowed ambient temperature can be calculated.

- The power loss is calculated by using the formula $((1/\eta) - 1) \times \text{output power} = \text{power losses (Pd)}$.
 η = efficiency of regulator. E.g 89.5 % = 0.895
- Find the thermal resistance (R_{th}) in the Thermal Resistance graph found in the Output section for each model. Calculate the temperature increase (ΔT).
 $\Delta T = R_{th} \times P_d$
- Max allowed ambient temperature is:
 Max T_{ref} - ΔT .

E.g PMP 5818UW P at 0m/s:

- $((\frac{1}{0.926}) - 1) \times 80 \text{ W} = 6.39 \text{ W}$
- $6.39 \text{ W} \times 15.8^\circ\text{C/W} = 101.0^\circ\text{C}$
- $130^\circ\text{C} - 101.0^\circ\text{C} = \text{max ambient temperature is } 29.0^\circ\text{C}$

The actual temperature will be dependent on several factors such as the PCB size, number of layers and direction of airflow.

Connections

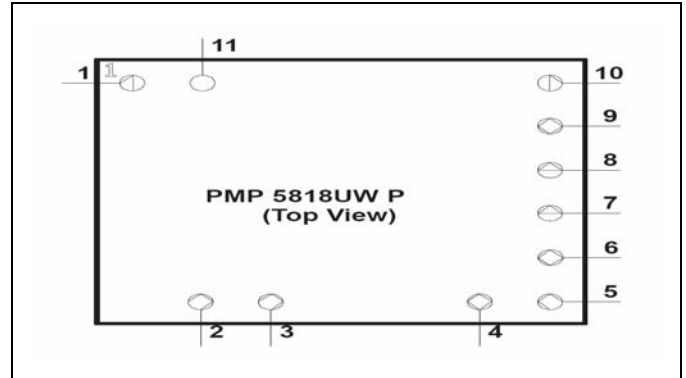

Pin	Designation	Function
1	SmartSync	This input pin synchronizes the switching frequency of the module to external clock frequency. The SmartSync feature can be used to synchronize the switching frequency of multiple PMP 5818UW P modules, aiding EMI noise suppression efforts. If unused, this pin should be connected to GND (PIN 3). For more information, please review the Application Information section.
2	V ₁	The positive input voltage power node to the module, which is referenced to common GND.
3	GND	This is the common ground connection for the V ₁ and V _o power connections. It is also the 0 V _{dc} reference for the control inputs.
4	GND	This is the common ground connection for the V ₁ and V _o power connections. It is also the 0 V _{dc} reference for the control inputs.
5	V _o	The regulated positive power output with respect to the GND.
6	+Sense	The sense input allows the regulation circuit to compensate for voltage drop between the module and the load. The +Sense pin should always be connected to V _o , either at the load for optimal voltage accuracy, or at the module (pin 5).

PMP 5000 series PoL Regulators
 Input 4.5 - 14 V, Output up to 16 A / 88 W

1/ 28701- BMR 657 Rev. A November 2017
 © Flex

7	-Sense	The sense input allows the regulation circuit to compensate for voltage drop between the module and the load. For optimal voltage accuracy, -Sense must be connected to GND(pin 4) , very close to the module (within 10 cm).
8	V _o Adjust	A 0.05 W 1% resistor must be directly connected between this pin and pin 7 (-Sense) to set the output voltage to a value higher than 0.69 V. The temperature stability of the resistor should be 100 ppm/°C (or better). The setpoint range for the output voltage is from 0.69V to 5.5 V. If left open circuit, the output voltage defaults to its lowest value. For further information, on output voltage adjustment see the related application note. The specification table gives the preferred resistor values for a number of standard output voltages..
9	Turbo Trans	This input pin adjusts the transient response of the regulator. To activate the Turbo Trans™ feature, a 1%, 50mW resistor must be connected between this pin and pin 6 (+Sense) very close to the module. For a given value of output capacitance, a reduction in peak output voltage deviation is achieved by using this feature. If unused, this pin must be left open-circuit. External capacitance must never be connected to this pin unless the Turbo Trans™ resistor value is a short, 0Ω.
10	Track	This is an analog control input that enables the output voltage to follow an external voltage. This pin becomes active typically 20 ms after the input voltage has been applied, and allows direct control of the output voltage from 0 V up to the nominal set-point voltage. Within the control voltage is raised above this range, the module regulates at its set-point voltage. The features allows the output voltage to rise simultaneously with other modules powered from the same input bus. If unused, this input should be connected to V _i . NOTE: Due to the undervoltage lockout feature, the output of the module cannot follow its own input voltage during power up. For more information, see the related application note.

11	Inhibit/ UVLO Adjust	The Inhibit pin is an open-collector/drain, negative logic input that is referenced to GND. Applying a low level ground signal to this input disables the module's output voltage. If the Inhibit pin is left open-circuit, the module produces an output whenever a valid input source is applied. This input is not compatible with TTL logic devices and should not be tied V _i or other voltage. This pin is also used for input undervoltage lockout (UVLO) programming. Connecting a resistor from this pin to GND (Pin 3) allows the ON threshold of the UVLO to be adjusted higher than the default value.
----	-------------------------	----------------------------------------------------------------------------------------------------------------------------------------------------------------------------------------------------------------------------------------------------------------------------------------------------------------------------------------------------------------------------------------------------------------------------------------------------------------------------------------------------------------------------------------------------------------------------------------------------------------------------------

PMP 5000 series PoL Regulators
 Input 4.5 - 14 V, Output up to 16 A / 88 W

1/ 28701- BMR 657 Rev. A November 2017

© Flex

Mechanical Information (Surface mount version)

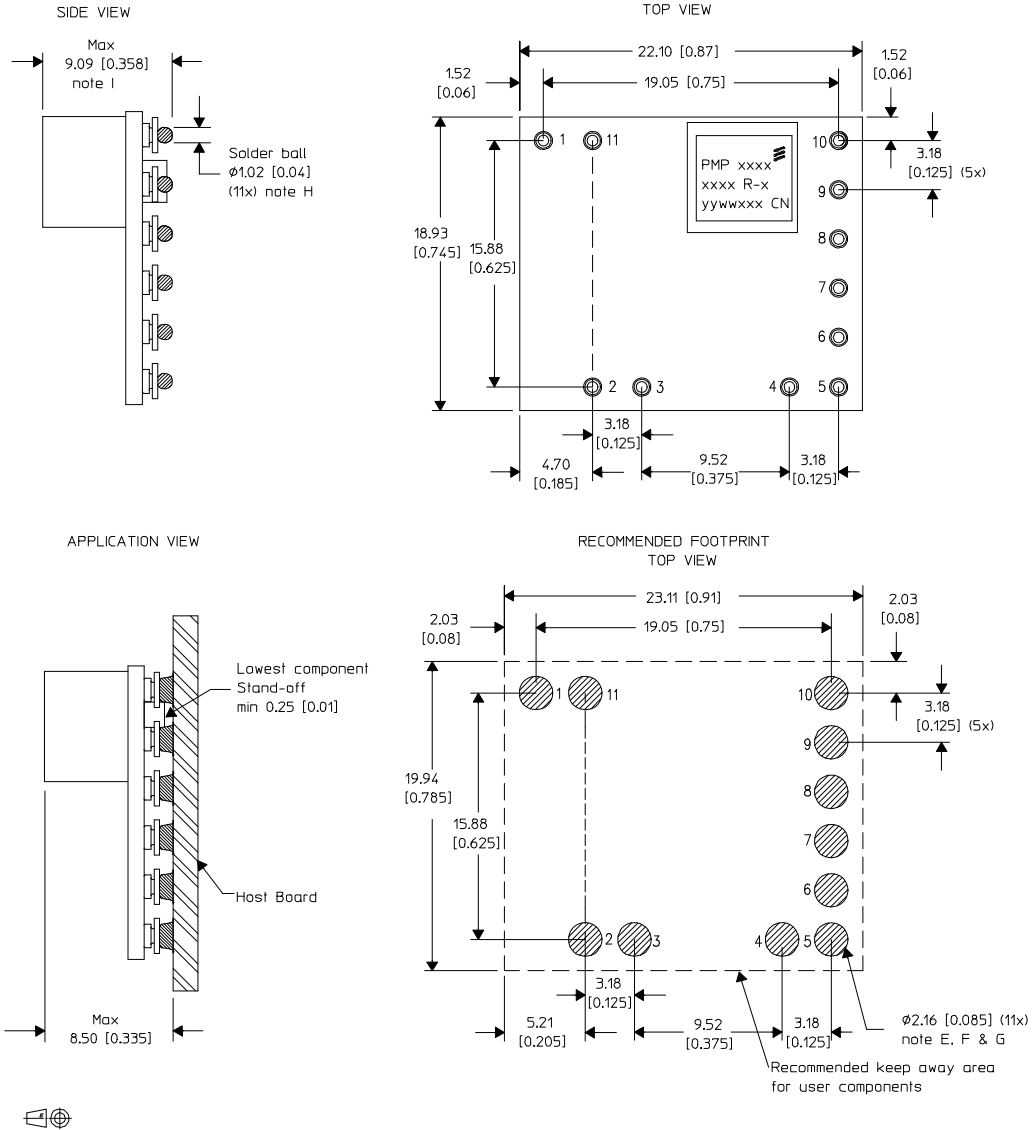

Notes:

- A. All linear dimensions are mm [inch].
- B. This drawing is subject to change without notice.
- C. 1 place decimals are ± 0.75 [± 0.030]
- D. 2 place decimals are ± 0.25 [± 0.010]
- E. Power pin connection should utilize two or more vias to the interior power plane of $\phi 0.63$ [0.025] per input, ground and output pin (or the electrical equivalent).

- F. Paste screen opening: $\phi 2.03$ [0.080] to $\phi 2.16$ [0.085]
 Paste screen thickness: 0.15 [0.006]
- G. Pad type: solder mask defined
- H. All pins: Material - Copper Alloy
 Plating - 10 μ m Tin over 4 μ m Nickel
 Solder Ball - Black collar 63 Sn / 37 Pb
 Blue collar 96.5 Sn / 3.0 Ag / 0.5 Cu
- I. Dimension prior to reflow solder

MECHANICAL DATA FOR THE PMP DC/DC REGULATOR

Weight: typical 5 g

Use recommended footprint and solder recommendations together with solder reflow recommendations to ensure a reliable interconnection.

PMP 5000 series PoL Regulators
 Input 4.5 - 14 V, Output up to 16 A / 88 W

1/ 28701- BMR 657 Rev. A November 2017
 © Flex

Mechanical Information (Through hole mount version)

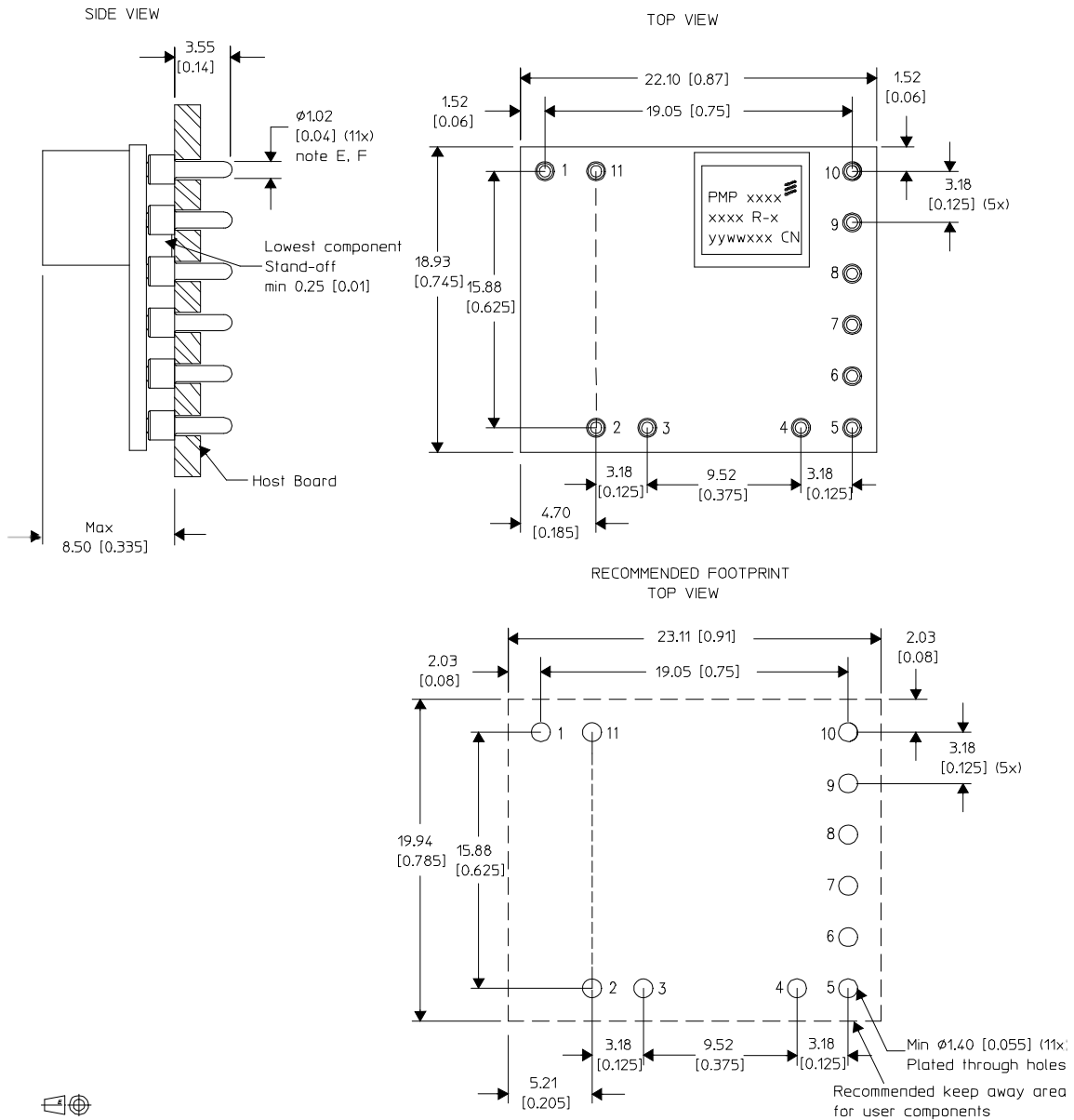

- Notes:
- A. All linear dimensions are mm [inch]
 - B. This drawing is subject to change without notice.
 - C. 1 place decimals are ± 0.75 [± 0.030]
 - D. 2 place decimals are ± 0.25 [± 0.010]
 - E. Pins are $\phi 1.02$ [0.040] with $\phi 1.78$ [0.070] stand-off shoulder.
 - F. All pins: Material - Copper Alloy
 Finish - 10 μ m Tin over 4 μ m Nickel

MECHANICAL DATA FOR THE PMP DC/DC REGULATOR
 Weight: typical 5 g
 Use recommended footprint and solder recommendations together with solder reflow recommendations to ensure a reliable interconnection.

PMP 5000 series PoL Regulators
Input 4.5 - 14 V, Output up to 16 A / 88 W

1/ 28701- BMR 657 Rev. A November 2017

© Flex

Soldering Information - Surface Mounting

The surface mount version of the product is intended for convection or vapor phase reflow SnPb or Pb-free processes. To achieve a good and reliable soldering result, make sure to follow the recommendations from the solder paste supplier, to use state-of-the-art reflow equipment and reflow profiling techniques as well as the following guidelines.

A no-clean flux is recommended to avoid entrapment of cleaning fluids in cavities inside the product or between the product and the host board. The cleaning residues may affect long time reliability and isolation voltage.

Minimum Pin Temperature Recommendations

Pin number 8 is chosen as reference location for the minimum pin temperature recommendations since this will likely be the coolest solder joint during the reflow process.

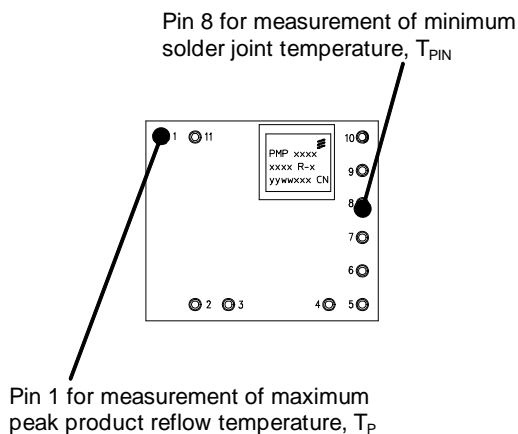

SnPb solder processes

For SnPb solder processes, a pin temperature (T_{PIN}) in excess of the solder melting temperature, (T_L +183°C for Sn63/Pb37) for more than 30 seconds, and a peak temperature of +210°C is recommended to ensure a reliable solder joint.

Lead-free (Pb-free) solder processes

For Pb-free solder processes, a pin temperature (T_{PIN}) in excess of the solder melting temperature (T_L +217 to

+221°C for Sn/Ag/Cu solder alloys) for more than 30 seconds, and a peak temperature of +235°C on all solder joints is recommended to ensure a reliable solder joint.

Peak Product Temperature Requirements

Pin 1 is chosen as reference location for the maximum (peak) allowed product temperature (T_P) since this will likely be the warmest part of the product during the reflow process.

To avoid damage or performance degradation of the product, the reflow profile should be optimized to avoid excessive heating. A sufficiently extended preheat time is recommended to ensure an even temperature across the host PCB, for both small and large devices. To reduce the risk of excessive heating is also recommended to reduce the time in the reflow zone as much as possible.

SnPb solder processes

For SnPb solder processes, the product is qualified for MSL 1 according to IPC/JEDEC standard J-STD-020C.

During reflow, T_P must not exceed +225°C at any time.

Lead-free (Pb-free) solder processes

For Pb-free solder processes, the product is qualified for MSL 3 according to IPC/JEDEC standard J-STD-020C.

During reflow, T_P must not exceed +260°C at any time.

PMP 5000 series PoL Regulators
 Input 4.5 - 14 V, Output up to 16 A / 88 W

1/ 28701- BMR 657 Rev. A November 2017
 © Flex

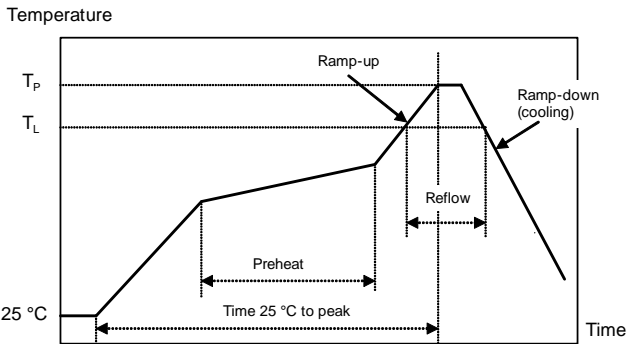

Reflow process specifications		Sn/Pb eutectic	Pb-free
Average ramp-up rate		3 °C/s max	3 °C/s max
Solder melting temperature (typical)	T _L	+183°C	+221°C
Minimum time above T _L		30 s	30 s
Minimum pin temperature	T _{PIN}	+210°C	+235°C
Peak product temperature	T _P	+225°C	+260°C
Average ramp-down rate		6°C/s max	6°C/s max
Time 25 °C to peak		6 minutes max	8 minutes max

PMP 5000 series PoL Regulators
 Input 4.5 - 14 V, Output up to 16 A / 88 W

1/ 28701- BMR 657 Rev. A November 2017
 © Flex

Soldering Information – Through Hole Mounting

The through hole mount version of the product is intended for manual or wave soldering. When wave soldering is used, the temperature on the pins is specified to maximum 270 °C for maximum 10 seconds.

A maximum preheat rate of 4°C/s and a temperature of max of +150°C is suggested. When soldering by hand, care should be taken to avoid direct contact between the hot soldering iron tip and the pins for more than a few seconds in order to prevent overheating.

A no-clean flux is recommended to avoid entrapment of cleaning fluids in cavities inside the product or between the product and the host board. The cleaning residues may affect long time reliability and isolation voltage.

Delivery Package Information

The TH version products are delivered in antistatic trays. The SMD version products are delivered in antistatic trays and antistatic carrier tape (EIA 481 standard).

Tray Specifications	
Material	Antistatic PET
Surface resistance	$10^6 < \text{Ohm/square} < 10^{12}$
Tray capacity	42 products/tray
Tray thickness	13 mm [0.512 inch]
Box capacity	210 products (5 full trays/box)
Bakability	The tray is not bakable.

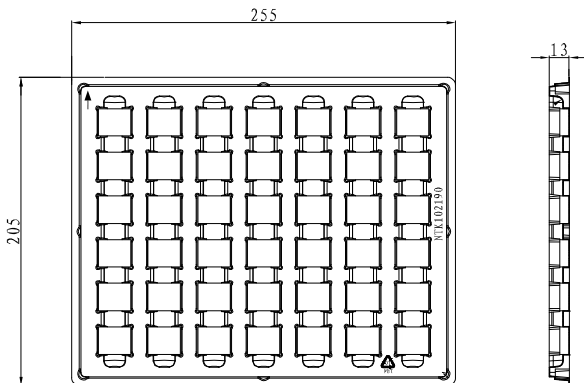

Carrier Tape Specifications	
Material	Antistatic PS
Surface resistance	$10^7 < \text{Ohm/square} < 10^{12}$
Bakability	The tape is not bakable.
Tape width	44 mm [1.732 inch]
Pocket pitch	32 mm [1.260 inch]
Pocket depth	9.09 mm [0.358 inch]
Reel diameter	381 mm [15 inch]
Reel capacity	200 products /reel

Non-Dry Pack Information

The through hole mount version of product is delivered in non-dry packing trays.

The lead (Pb) surface mount version of product is delivered in non-dry packing trays or tape & reel.

Dry Pack Information

The lead free (Pb-free) surface mount version of the product is delivered in trays or tape & reel. These inner shipment containers are dry packed in standard moisture barrier bags according to IPC/JEDEC standard J-STD-033 (Handling, packing, shipping and use of moisture/reflow sensitivity surface mount devices).

Using products in high temperature Pb-free soldering processes requires dry pack storage and handling. In case the products have been stored in an uncontrolled environment and no longer can be considered dry, the modules must be baked according to J-STD-033.

PMP 5000 series PoL Regulators
Input 4.5 - 14 V, Output up to 16 A / 88 W

1/ 28701- BMR 657 Rev. A November 2017

© Flex

Product Qualification Specification



Characteristics			
External visual inspection	IPC-A-610		
Change of temperature (Temperature cycling)	IEC 60068-2-14 Na	Temperature range Number of cycles Dwell/transfer time	-40 to +100 °C 1000 15 min/0-1 min
Cold (in operation)	IEC 60068-2-1 Ad	Temperature T _A Duration	-45°C 72 h
Damp heat	IEC 60068-2-67 Cy	Temperature Humidity Duration	+85 °C 85 % RH 1000 hours
Dry heat	IEC 60068-2-2 Bd	Temperature Duration	+125 °C 1000 h
Immersion in cleaning solvents	IEC 60068-2-45 XA Method 2	Water Glycol ether	+55° C +35° C
Mechanical shock	IEC 60068-2-27 Ea	Peak acceleration Duration	100 g 6 ms
Moisture reflow sensitivity ¹	J-STD-020C	level 1 (SnPb-eutectic) level 3 (Pb Free)	225° C 260° C
Operational life test	MIL-STD-202G method 108A	Duration	1000 h
Resistance to soldering heat ²	IEC 60068-2-20 Tb Method 1A	Solder temperature Duration	270° C 10-13 s
Robustness of terminations	IEC 60068-2-21 Test Ua1 IEC 60068-2-21 Test Ue1	Through hole mount products Surface mount products	All leads All leads
Solderability	IEC 60068-2-58 test Td ¹ IEC 60068-2-20 test Ta ²	Preconditioning Temperature, SnPb Eutectic Temperature, Pb-free Preconditioning Temperature, SnPb Eutectic Temperature, Pb-free	150 °C dry bake 16 h 215° C 235° C Steam ageing 235 ° C 245 ° C
Vibration, broad band random	IEC 60068-2-64 Fh, method 1	Frequency Spectral density Duration	10 to 500 Hz 0.07 g ² /Hz 10 min in each perpendicular direction

Note 1: Only for products intended for reflow soldering (surface mount products)





Note 2: Only for products intended for wave soldering (plated through hole products)

Looking for pricing, stock, or lifecycle information?

Click below to explore more details on WIN SOURCE:

-  [View PMP5818UWSR](#) on WIN SOURCE
-  [Flex Power Modules](#) Information

Optimize Your Supply Chain with WIN SOURCE Solutions

-  Global Sourcing Solution
-  Obsolete Management
-  Cost Control Management
-  Shortage Management
-  Alternative Solution
-  Excess Inventory Management