

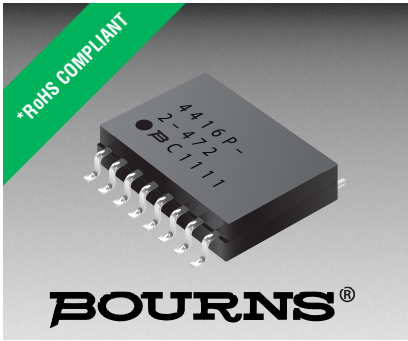

**THE DATASHEET OF
4420P-2-472LF**





Features

- RoHS compliant*
- Standard E.I.A. package compatible with automatic placement equipment
- Compliant leads to reduce solder joint fatiguing
- Tape and reel packaging standard
- Standard electrical schematics: isolated, bussed, dual terminator
- Custom circuits are available
- Now available with improved tolerance to $\pm 0.5\%$

4400P Series - Thick Film Surface Mounted Wide Body

Product Characteristics

Resistance Range	10 ohms to 2.2 megohms
Maximum Operating Voltage	50 V
Temperature Coefficient of Resistance	50 Ω and above ± 100 ppm/ $^{\circ}$ C below 50 Ω ± 250 ppm/ $^{\circ}$ C
TCR Tracking	50 ppm/ $^{\circ}$ C maximum; equal values
Operating Temperature	-55 $^{\circ}$ C to +125 $^{\circ}$ C
Insulation Resistance	10,000 megohms minimum
Dielectric Withstanding Voltage	200 VRMS
Lead Solderability	Meet requirements of MIL-STD-202 Method 208

Environmental Characteristics

TESTS PER MIL-STD-202	ΔR MAX.
Short Time Overload	$\pm 0.25\%$
Load Life	$\pm 1.00\%$
Moisture Resistance	$\pm 0.50\%$
Resistance to Soldering Heat	$\pm 0.25\%$
Thermal Shock	$\pm 0.25\%$

Physical Characteristics

Flammability	Conforms to UL94V-0
Lead Frame Material	Copper, solder coated
Body Material	Novolac epoxy

How To Order

44 20 P - 1 - 103 LF

Model (44 = SMD SOL Pkg.)	44
Number of Pins	20
Electrical Configuration	P
Resistance Code	103
Resistance Tolerance	F
Terminations	LF

• 1 or 4 = Isolated*
 • 2 = Bussed*
 • 3 = Dual Terminator*
 • First 2 digits are significant
 • Third digit represents the number of zeros to follow.
 • Blank = $\pm 2\%$ (see "Resistance Tolerance" on next page for resistance range)
 • F = $\pm 1\%$ (100 ohms - 1 megohm)
 • D = $\pm 0.5\%$ (100 ohms - 1 megohm)

• All electrical configurations EXCEPT T03:
 LF = Tin-plated (RoHS compliant)
 • ONLY electrical configuration T03:
 L = Tin-plated (RoHS compliant)

*For tube packaging, use T01, T02, T03 or T04. Consult factory for other available options.

Package Power Temp. Derating Curve

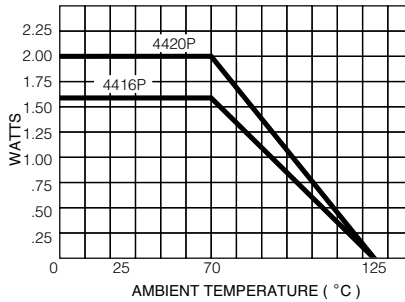

Package Power Rating at 70 $^{\circ}$ C

4420P	2.00 watts
4416P	1.60 watts

Recommended Land Pattern

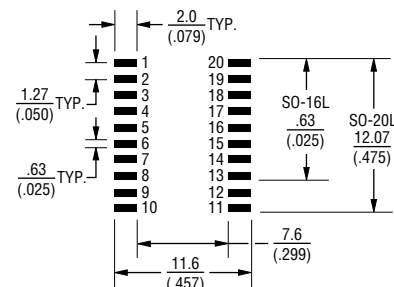

NOTE: Land pattern dimensions are based on design rules established by the Institute for Interconnecting and Packaging Electronic Circuits in IPC-SM-782.

For Standard Values Used in Capacitors, Inductors, and Resistors, [click here](#).

Product Dimensions

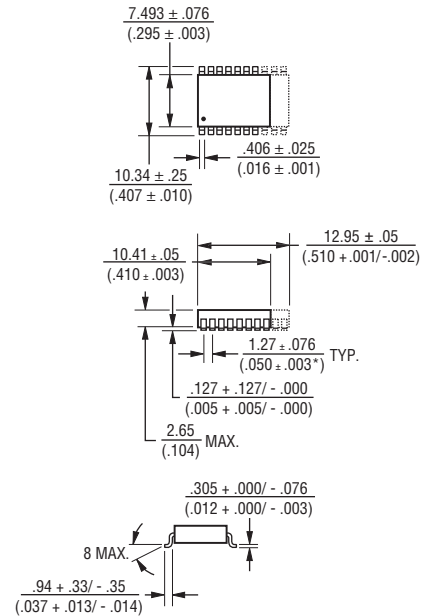

Governing dimensions are in metric. Dimensions in parentheses are inches and are approximate.

*Terminal centerline to centerline measurements made at point of emergence of the lead from the body.

Typical Part Marking

Represents total content. Layout may vary.

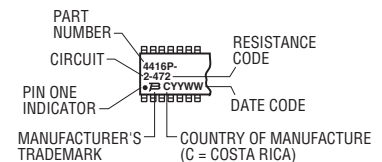

*RoHS Directive 2002/95/EC Jan. 27, 2003 including annex and RoHS Recast 2011/65/EU June 8, 2011.

Specifications are subject to change without notice.

The device characteristics and parameters in this data sheet can and do vary in different applications and actual device performance may vary over time. Users should verify actual device performance in their specific applications.

For information on specific applications, download Bourns' application notes:

- DRAM Applications
- Dual Terminator Resistor Networks
- R/2R Ladder Networks
- SCSI Applications

4400P Series - Thick Film Surface Mounted Wide Body **BOURNS®**

Isolated Resistors (1 and 4 Circuits)

Model 4416P-1
Model 4420P-1 (Shown)

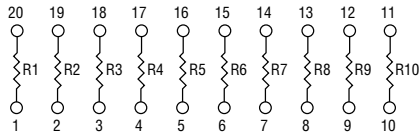

Model 4416P-4
Model 4420P-4 (Shown)

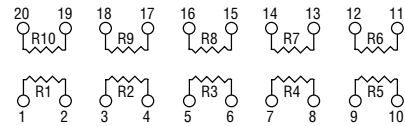

Resistance Tolerance
10 ohms to 49 ohms ±1 ohm
50 ohms to 2.2 megohms ±2 %*

Power Rating per Resistor
1 Circuit at 70 °C 0.160 watt
4 Circuit at 70 °C 0.160 watt

Resistor Power Temp. Derating Curve

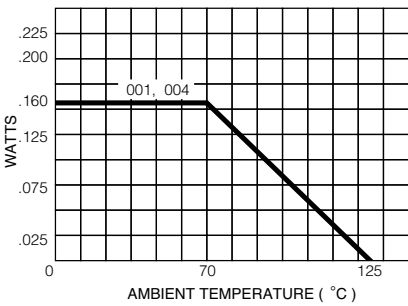

Bussed Resistors (2 Circuit)

Model 4416P-2
Model 4420P-2 (Shown)

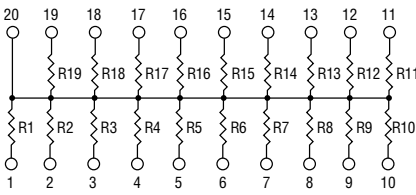

Resistance Tolerance
10 ohms to 49 ohms ±1 ohm
50 ohms to 2.2 megohms ±2 %*

Power Rating per Resistor
2 Circuit at 70 °C 0.160 watt

Resistor Power Temp. Derating Curve

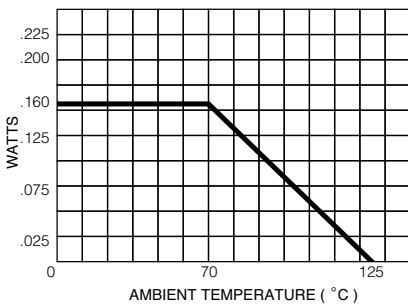

Dual Terminator (3 Circuit)

Model 4416P-3
Model 4420P-3 (Shown)

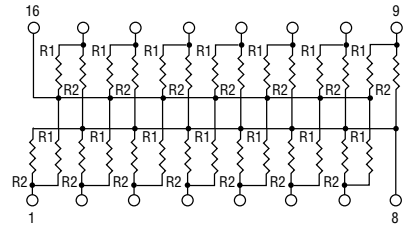

4420P-3 terminates 16 lines, convenient for a 16-bit computer bus.

Resistance Tolerance
Below 100 ohms ±2 ohms
100 ohms to 2.2 megohms ±2 %*

Power Rating per Resistor
3 Circuit at 70 °C 0.115 watt

Resistor Power Temp. Derating Curve

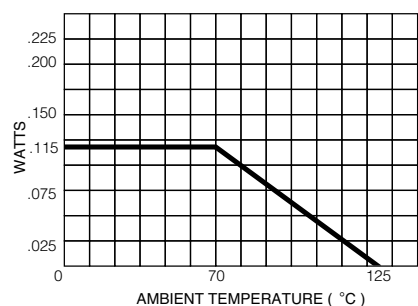

Popular Resistance Values (1, 4 and 2 Circuits)**

Ohms	Code	Ohms	Code	Ohms	Code	Ohms	Code	Ohms	Code
10	100	180	181	1,800	182	15,000	153	120,000	124
22	220	220	221	2,000	202	18,000	183	150,000	154
27	270	270	271	2,200	222	20,000	203	180,000	184
33	330	330	331	2,700	272	22,000	223	220,000	224
39	390	390	391	3,300	332	27,000	273	270,000	274
47	470	470	471	3,900	392	33,000	333	330,000	334
56	560	560	561	4,700	472	39,000	393	390,000	394
68	680	680	681	5,600	562	47,000	473	470,000	474
82	820	820	821	6,800	682	56,000	563	560,000	564
100	101	1,000	102	8,200	822	68,000	683	680,000	684
120	121	1,200	122	10,000	103	82,000	823	820,000	824
150	151	1,500	152	12,000	123	100,000	104	1,000,000	105

* Add "F" after resistance code for ±1 % tolerance available from 100 Ω through 1M Ω, or add "D" after resistance code for ±0.5 % tolerance available from 100 Ω through 1M Ω.
Part number suffix examples: -103 = 10K Ω, ±2 %; -103F = 10K Ω, ±1 %; -103D = 10K Ω, ±0.5 %

** Non-standard values available, within resistance range.

Popular Resistance Values (3 Circuit)**

Resistance			
Ohms		Code	
R ₁	R ₂	R ₁	R ₂
160	240	161	241
180	390	181	391
220	270	221	271
220	330	221	331
330	390	331	391
330	470	331	471
3,000	6,200	302	622

Surface Mounted Ordering Guide

BOURNS®

Electrical Configuration	*Circuit Codes		Examples
	Tape & Reel	Tubes	
Isolated	1	T01	4416P-1-101
Bussed	2	T02	Isolated Circuit in Tape & Reel Package
Dual Terminated	3	T03	4416P-T01-101
Adj. Isolated	4	T04	Isolated Circuit in Slide Tube Package

*4416P-X-RC: To specify package type, replace "X" with appropriate "Circuit Code".

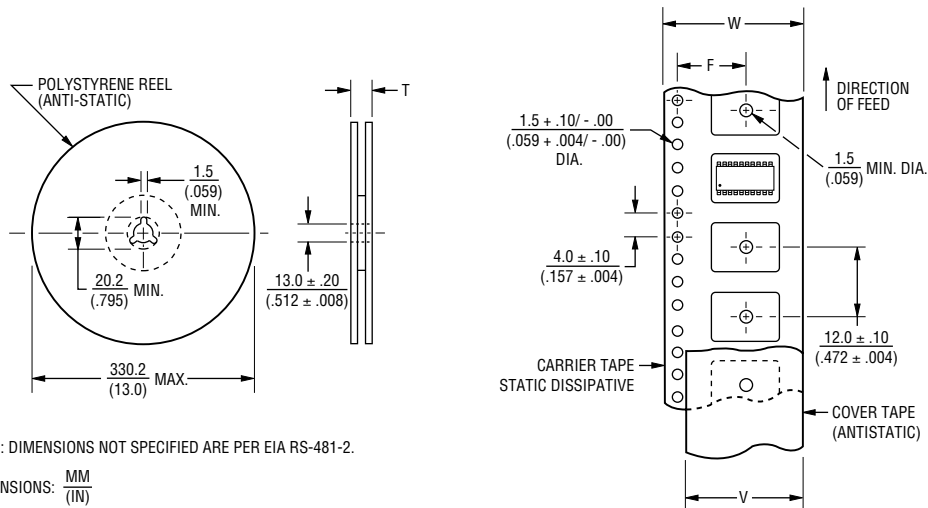

NOTE: DIMENSIONS NOT SPECIFIED ARE PER EIA RS-481-2.

DIMENSIONS: $\frac{\text{MM}}{(\text{IN})}$

Model	Standard Quantity per Reel	Carrier Tape Width (W)	Cover Tape Width (W)	Reel Width (T)	Pocket Center (F)
4416P	1,500	$\frac{24.0 \pm .30}{(.945 \pm .012)}$	$\frac{21.0}{(.827)}$ NOM.	$\frac{30.4}{(1.197)}$ MAX.	$\frac{11.5 \pm .10}{(.453 \pm .004)}$
4420P	1,500				

Leader Length = 500 mm min. } Empty Component Pockets
 Trailer Length = 500 mm min. } Sealed with Cover Tape

Looking for pricing, stock, or lifecycle information?

Click below to explore more details on WIN SOURCE:

- [View 4420P-2-472LF on WIN SOURCE](#)
- [Bourns Inc. Information](#)

Optimize Your Supply Chain with WIN SOURCE Solutions

- ✓ Global Sourcing Solution
- ✓ Obsolete Management
- ✓ Cost Control Management
- ✓ Shortage Management
- ✓ Alternative Solution
- ✓ Excess Inventory Management