

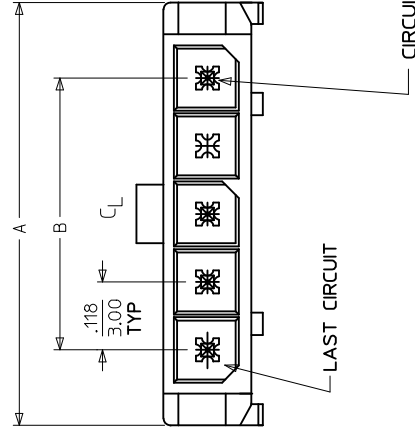

**THE DATASHEET OF**  
**43650-0315**

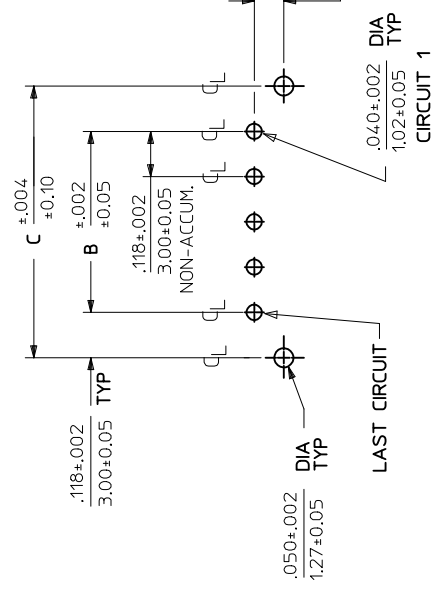

OPTIONAL VOIDED CKT  
SEE CHART FOR LOCATIONS

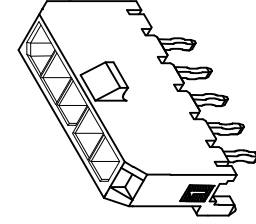
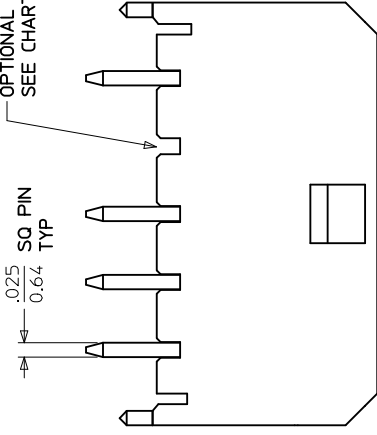

PCB LAYOUT: COMPONENT SIDE  
RECOMMENDED PCB THICKNESS: .062/157

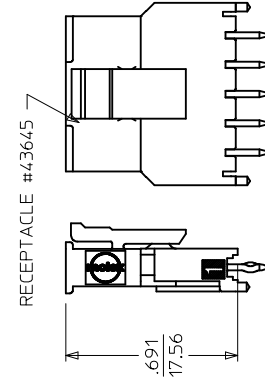
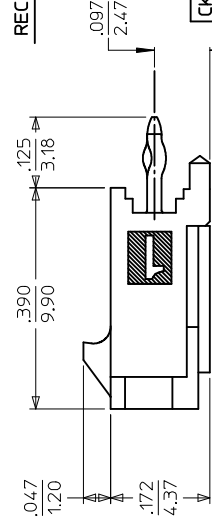

NOTES:

- HOUSING MATERIAL: LIQUID CRYSTAL POLYMER, GLASS FILLED, UL94V-0, COLOR: BLACK
- TERMINAL MATERIAL: BRASS ALLOY
- FINISH:
  - A = .000060/(0.00152) MIN. REFLOWED MATTE TIN OVER .000050/(0.00127) MIN. NICKEL PLATE. (FINISH IS BRIGHT IN APPEARANCE, THICKNESS AS APPLIED PRIOR TO REFLOW)
  - B = .000015/(0.00038) MIN. SELECT GOLD IN CONTACT AREA .000100/(0.00254) MIN. SELECT MATTE TIN ON SOLDER TAILS BOTH OVER .000050/(0.00127) NICKEL OVERALL
  - C = .000030/(0.00076) MIN. SELECT GOLD IN CONTACT AREA .000100/(0.00254) MIN. SELECT MATTE TIN ON SOLDER TAILS BOTH OVER .000050/(0.00127) NICKEL OVERALL
- PRODUCT SPECIFICATION: PS-43650
- TRAY PACKAGED : SEE MOLEX DRAWING PK-70873-0811
- MATES WITH MICRO FIT (3.0) RECEPTACLE SERIES 43645
- THIS PART CONFORMS TO CLASS 'B' REQUIREMENTS OF PRODUCT SPECIFICATION PS-45499-002.

MATED MICRO FIT CONNECTORS

FINISH A		FINISH	
CKTS MATERIAL NO:	VOID CKT	CKTS MATERIAL	FINISH
02		43650-0215	02
03		43650-0315	03
04		43650-0415	04
05		43650-0515	05
06		43650-0615	06
07		43650-0715	07
08		43650-0815	08
09		43650-0915	09
10		43650-1015	10
11		43650-1115	11
12		43650-1215	12
03		43650-0330	03
04			04
05		43650-9915	05
05		43650-0530	05
06		43650-0630	06
07		43650-0730	07
09			09

QUALITY SYMBOLS	GENERAL TOLERANCES (UNLESS SPECIFIED)	IN/MM	DIMENSION STYLE
= 0	MM	IN/MM	DRAWN BY DATE
= 0	INCH		SAMIEC 2000/07/07
= 0	± .010		CHECKED BY DATE
= 0	± .014		MUELLER 2000/07/07
	± .036		APPROVED BY DATE
	±		EDGLEY 2000/07/07
	ANGULAR ±1/2°		MATERIAL NO.
	DRAFT WHERE APPLICABLE		SEE CHART
	MUST REMAIN WITHIN DIMENSIONS		THIS DRAWING CONTAINS INCORPORATED AND S

REV	DESCRIPTION
F3	ADD -1532 -0930
	EC NO: UCP2017-2430
	DRW:BAPELDRN 2017/05/05
	CHKD:JOFX 2017/05/05
	APP:FSMITH 2017/05/22

## Looking for pricing, stock, or lifecycle information?

Click below to explore more details on WIN SOURCE:

 [View 43650-0315 on WIN SOURCE](#)

 [Molex, LLC Information](#)

## Optimize Your Supply Chain with WIN SOURCE Solutions

-  Global Sourcing Solution
-  Obsolete Management
-  Cost Control Management
-  Shortage Management
-  Alternative Solution
-  Excess Inventory Management