



# THE DATASHEET OF PKC-136





**MAIN PRODUCT CHARACTERISTICS**

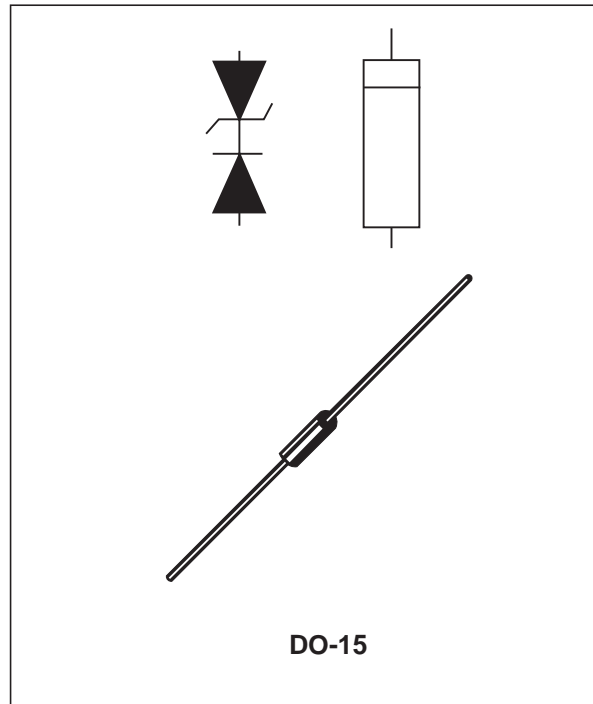
<b>V<sub>BR</sub></b>	160Vdc
<b>V<sub>DRM</sub></b>	700Vdc
<b>P</b>	1.5W

**FEATURES**

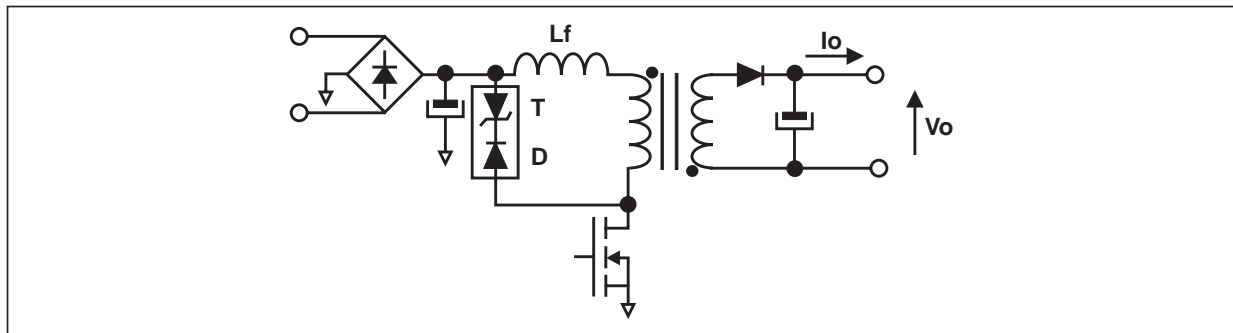
- Protection of the Mosfet in flyback power supply
- TRANSIL™ and blocking diode in a single package

**BENEFITS**

- Accurate voltage clamping regardless load
- Reduced current loop
- Reduced EMI emission
- High integration
- Fast assembly
- Reduced losses in stand by mode



**BASIC CONNECTION**



**ABSOLUTE MAXIMUM RATINGS** (limiting values)

Symbol	Parameter	Value	Unit
T <sub>stg</sub>	Storage temperature	- 40 to + 150	°C
T <sub>j</sub>	Junction temperature	150	°C
P	Maximum power dissipation T°lead = 90°C	1.5	W

**ELECTRICAL CHARACTERISTICS TRANSIL**

Symbol	Parameter	Test conditions		Value			Unit
				Min.	Typ.	Max.	
I <sub>RM</sub>	Leakage current	V <sub>R</sub> = 136V	T <sub>j</sub> = 25°C			1	μA
			T <sub>j</sub> = 125°C			10	
V <sub>BR</sub>	Breakdown voltage	I <sub>R</sub> = 1mA pulse test < 50ms	T <sub>j</sub> = 25°C	150	160	170	V
R <sub>d</sub>	Dynamical Resistance	tp < 500ns between I = 0.5Amps and I = 1.5Amps	T <sub>j</sub> = 125°C			4	Ω
αT	Temperature Coefficient					10.8	10 <sup>-4</sup> /°C
V <sub>sCL</sub>	Surge Clamping voltage	I <sub>pp</sub> = 2.7Amps 10/1000μs				219	V

**CALCULATION OF THE CLAMPING VOLTAGE:**

In repetitive mode and for low current rating, use the equation (1) and (2) to calculate the breakdown voltage V<sub>BR</sub> of the transil versus the operating junction temperature and use the equation (3) to calculate the clamping voltage versus the transil current I<sub>pp</sub> and the temperature.

$$\Delta V_{BR} = \alpha T (T_j - 25) V_{BR}(25^\circ C) \quad (1)$$

$$V_{BR}(T_j) = V_{BR}(25^\circ C) + \Delta V_{BR} \quad (2)$$

$$V_{CL}(T_j) = V_{BR}(T_j) + R_d \cdot I_{pp} \quad (3)$$

**ELECTRICAL CHARACTERISTICS DIODE (T<sub>j</sub> = 25°C unless otherwise specified)**

Symbol	Parameter	Tests conditions		Value			Unit
				Min.	Typ.	Max.	
I <sub>R</sub>	Reverse leakage current	V <sub>R</sub> = V <sub>R<sub>RM</sub></sub>	T <sub>j</sub> = 25°C			3	μA
			T <sub>j</sub> = 125°C		3	20	
V <sub>R<sub>RM</sub></sub>	Repetitive Peak Reverse Voltage	T <sub>j</sub> = 25°C		700			V
tr <sub>r</sub>	Reverse Recovery Time	I <sub>F</sub> = 1A   dI <sub>F</sub> / dt = -50A/μs V <sub>R</sub> = 30V				45	ns
V <sub>FP</sub>	Peak Forward Voltage	I <sub>F</sub> = 3A dI <sub>F</sub> / dt = 100A/μs	T <sub>j</sub> = 25°C			12	V
			T <sub>j</sub> = 125°C			18	

**CAPACITANCE**

Symbol	Parameter	Typical Value	Unit
C	Total Parasitic capacitance 1MHz 30mV	35	pF

**THERMAL RESISTANCES**

Symbol	Parameter	Value	Unit
$R_{th(j-l)}$	Junction to leads L = 10mm	40	°C/W
$R_{th(j-a)}$	Junction to ambient condition see note 1	105	°C/W

**Note 1:** Device mounted on a epoxy FR4 board of 35µm thickness

Lead Length: 10mm

Pad diameter: 4mm

Track width: 1mm

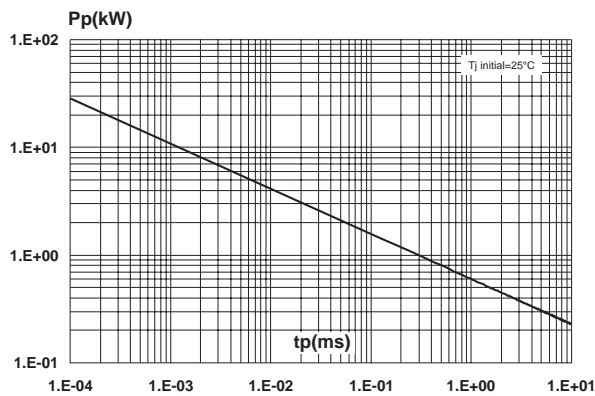
Track length: 25mm

The  $R_{th(j-a)}$  can be reduced by replacing the Cu track by plan:

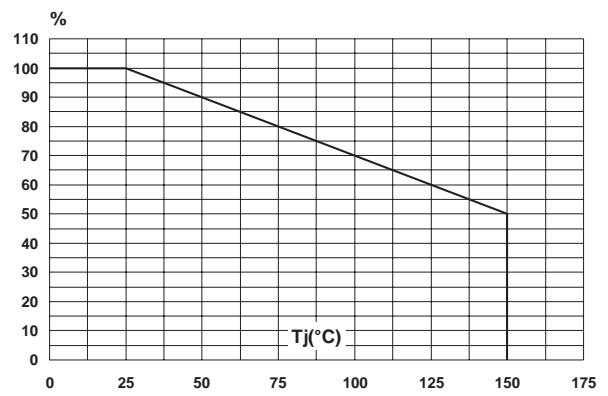
$S(Cu) = 1.5cm^2/lead$      $R_{th(j-a)} = 65°C/W$

$S(Cu) = 3.5cm^2/lead$      $R_{th(j-a)} = 60°C/W$

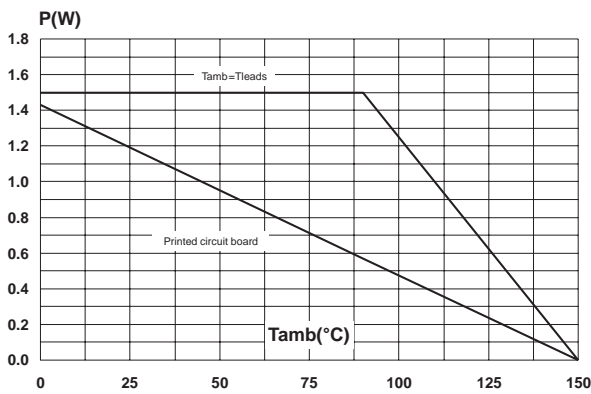
**Fig. 1:** Peak pulse power versus exponential pulse duration.



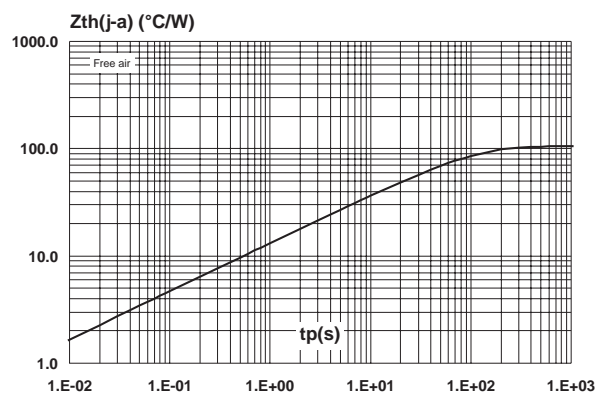
**Fig. 2:** Relative variation of peak pulse power versus initial junction temperature.



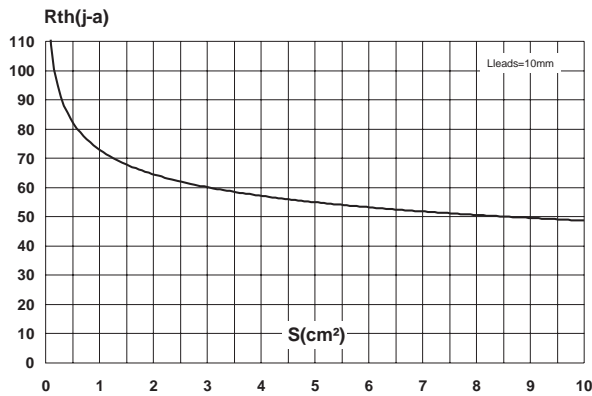
**Fig. 3:** Average power dissipation versus ambient temperature.



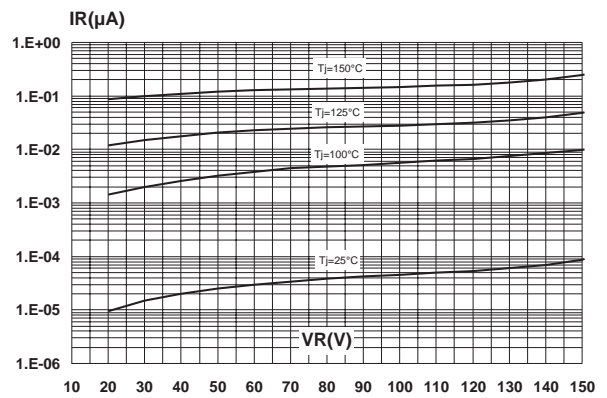
**Fig. 4:** Variation of thermal impedance junction to ambient versus pulse duration (printed circuit board epoxy FR4)



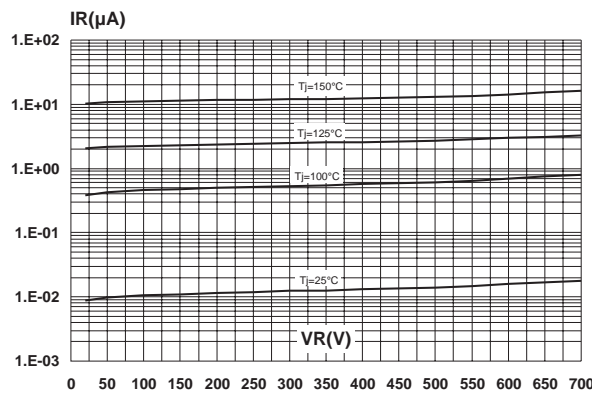
**Fig. 5:** Thermal resistance junction to ambient versus copper surface under each lead.



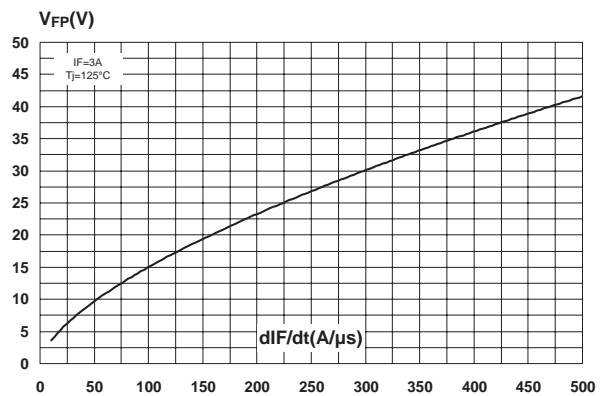
**Fig. 6-1:** Reverse leakage current versus reverse voltage applied (typical values, for Transil).



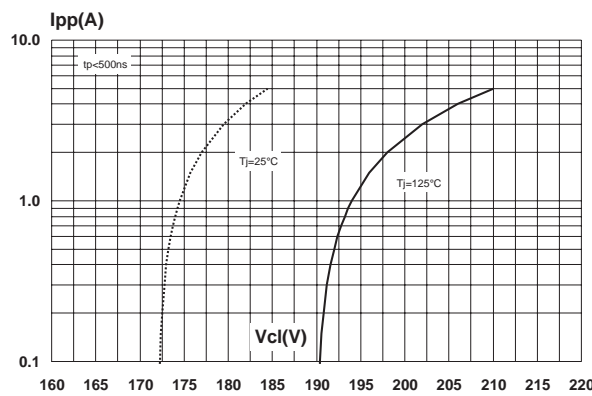
**Fig. 6-2:** Reverse leakage current versus reverse voltage applied (typical values, for diode).



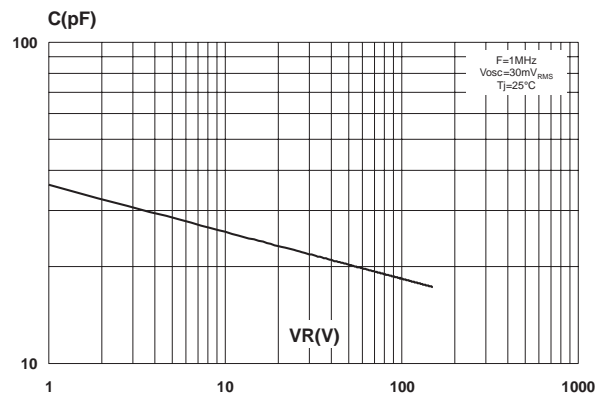
**Fig. 7:** Transient peak forward voltage versus  $dI_F/dt$  (90% confidence).



**Fig. 8:** Clamping voltage versus peak pulse current (maximum values).

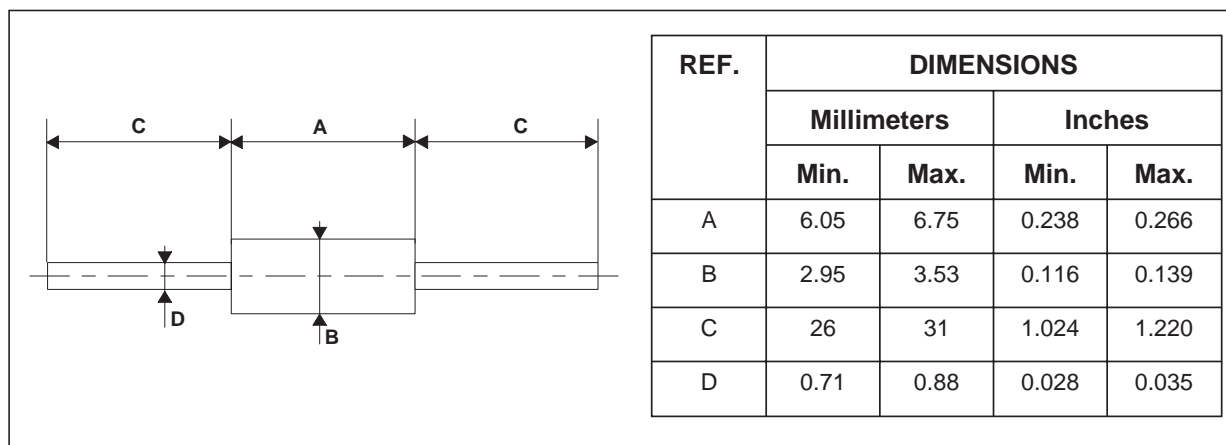


**Fig. 9:** Junction capacitance versus reverse voltage applied on clamping characteristic (typical values).



**PACKAGE MECHANICAL DATA**

DO-15



Ordering type	Marking	Package	Weight	Base qty	Delivery mode
PKC136	Partnumber Diode cathode ring	DO-15	0.4g	1000	Ammopack
PKC136-RL	Partnumber Diode cathode ring	DO-15	0.4g	6000	Tape and reel

Information furnished is believed to be accurate and reliable. However, STMicroelectronics assumes no responsibility for the consequences of use of such information nor for any infringement of patents or other rights of third parties which may result from its use. No license is granted by implication or otherwise under any patent or patent rights of STMicroelectronics. Specifications mentioned in this publication are subject to change without notice. This publication supersedes and replaces all information previously supplied. STMicroelectronics products are not authorized for use as critical components in life support devices or systems without express written approval of STMicroelectronics.

The ST logo is a registered trademark of STMicroelectronics

© 2001 STMicroelectronics - Printed in Italy - All rights reserved.

STMicroelectronics GROUP OF COMPANIES



Australia - Brazil - China - Finland - France - Germany - Hong Kong - India - Italy - Japan - Malaysia  
Malta - Morocco - Singapore - Spain - Sweden - Switzerland - United Kingdom - U.S.A.

<http://www.st.com>



## Looking for pricing, stock, or lifecycle information?

Click below to explore more details on WIN SOURCE:

-  [View PKC-136 on WIN SOURCE](#)
-  [STMicroelectronics](#) Information

## Optimize Your Supply Chain with WIN SOURCE Solutions

-  Global Sourcing Solution
-  Obsolete Management
-  Cost Control Management
-  Shortage Management
-  Alternative Solution
-  Excess Inventory Management