



**THE DATASHEET OF  
PKB411CPI**



**PKB 4000C Series DC-DC Converters**  
**Input 36-75 V, Output up to 60 A / 144 W**

EN/LZT 146 377 R5A      November 2017  
 © Flex

### Key Features

- Industry standard low profile Eighth-brick  
 58.4 x 22.7 x 8.6 mm (2.3 x 0.89 x 0.34 in.)
- High efficiency, typ. 91 % at 3.3V/40A
- 1500 Vdc input to output isolation
- Meets isolation requirements equivalent to basic insulation according to IEC/EN/UL 60950
- More than 2 million hours MTBF

### General Characteristics

- Suited for narrow board pitch applications  
 (15 mm/0.6 in)
- Secondary side control for tighter regulation
- Over temperature protection
- Over current protection
- Over voltage protection
- Optional latching OVP, OCP, OTP
- Monotonic startup
- Start up into Pre-biased load
- Remote sense
- Remote control
- Output voltage adjust function
- Through hole and surface mount option
- Optional baseplate
- Highly automated manufacturing ensures quality
- ISO 9001/14001 certified supplier



### Safety Approvals



### Design for Environment



Meets requirements in high-temperature lead-free soldering processes.

### Contents

Ordering Information	2
General Information	2
Safety Specification	3
Absolute Maximum Ratings	4
Electrical Specification	
1.0 V, 50 A / 50 W	PKB 4518NC ..... 5
1.2 V, 60 A / 72 W	PKB 4718LC ..... 9
1.5 V, 60 A / 90 W	PKB 4918HC ..... 13
1.8 V, 60 A / 108 W	PKB 4118GC ..... 17
3.3 V, 40 A / 132 W	PKB 4110C ..... 21
5.0 V, 28 A / 140 W	PKB 4111C ..... 25
12 V, 12 A / 144 W	PKB 4113C ..... 29
EMC Specification	33
Operating Information	34
Thermal Consideration	36
Connections	37
Mechanical Information	38
Soldering Information	41
Delivery Information	42
Product Qualification Specification	43

## Technical Specification

**PKB 4000C Series DC-DC Converters**  
Input 36-75 V, Output up to 60 A / 144 W

EN/LZT 146 377 R5A

November 2017

© Flex

## Ordering Information

Product program	Output
PKB 4518NC	1.0 V, 50 A / 50 W
PKB 4718LC	1.2 V, 60 A / 72 W
PKB 4918HC	1.5 V, 60 A / 90 W
PKB 4118GC	1.8 V, 60 A / 108 W
PKB 4110C	3.3 V, 40 A / 132 W
PKB 4111C	5.0 V, 28 A / 140 W
PKB 4113C	12 V, 12 A / 144 W

## Product number and Packaging

PKB 4XXXX n <sub>1</sub> n <sub>2</sub> n <sub>3</sub> n <sub>4</sub>							
Options	n <sub>1</sub>	n <sub>2</sub>	n <sub>3</sub>	n <sub>4</sub>	n <sub>5</sub>	n <sub>6</sub>	n <sub>7</sub>
Mounting	o						
Remote Control logic		o					
Latching protection			o				
Stand-off				o			
Baseplate					o		
Lead length						o	
Delivery package information							o

Options	Description	
n <sub>1</sub>	PI SI	Through hole Surface mount
n <sub>2</sub>	P	Negative * Positive
n <sub>3</sub>	LI LT LV LP LIT LIV LPA	Latching OCP Latching OTP Latching OVP Latching OTP and OVP Latching OCP and OTP Latching OCP and OVP All protection features latching
n <sub>4</sub>	M	Increased Stand-off
n <sub>5</sub>	HS	Baseplate
n <sub>6</sub>	LA LB LC	5.30 mm * 3.69 mm 4.57 mm 2.79 mm
n <sub>7</sub>	/B	Tray

Example a through-hole mounted, positive logic, short pin, 3.3V baseplated product with Latching OCP and tray packaging would be **PKB 4110C PIPLHSLA/B**.  
Increased stand-off LA, LB and LC pin will be cut-pins.

\* Standard variant (i.e. no option selected).

## General Information

## Reliability

The failure rate ( $\lambda$ ) and mean time between failures (MTBF=  $1/\lambda$ ) is calculated at max output power and an operating ambient temperature ( $T_A$ ) of +40°C. Flex Power Modules uses Telcordia SR-332 Issue 2 Method 1 to calculate the mean steady-state failure rate and standard deviation ( $\sigma$ ).

Telcordia SR-332 Issue 2 also provides techniques to estimate the upper confidence levels of failure rates based on the mean and standard deviation.

Mean steady-state failure	Std. deviation, $\sigma$
390 nFailures/h	45.2 nFailures/h

MTBF (mean value) for the PKB-C series = 2.6 Mh.  
MTBF at 90% confidence level = 2.2 Mh

## Compatibility with RoHS requirements

The products are compatible with the relevant clauses and requirements of the RoHS directive 2011/65/EU and have a maximum concentration value of 0.1% by weight in homogeneous materials for lead, mercury, hexavalent chromium, PBB and PBDE and of 0.01% by weight in homogeneous materials for cadmium.

Exemptions in the RoHS directive utilized in Flex Power Modules products are found in the Statement of Compliance document.

Flex Power Modules fulfills and will continuously fulfill all its obligations under regulation (EC) No 1907/2006 concerning the registration, evaluation, authorization and restriction of chemicals (REACH) as they enter into force and is through product materials declarations preparing for the obligations to communicate information on substances in the products.

## Quality Statement

The products are designed and manufactured in an industrial environment where quality systems and methods like ISO 9000, Six Sigma, and SPC are intensively in use to boost the continuous improvements strategy. Infant mortality or early failures in the products are screened out and they are subjected to an ATE-based final test. Conservative design rules, design reviews and product qualifications, plus the high competence of an engaged work force, contribute to the high quality of the products.

## Warranty

Warranty period and conditions are defined in Flex Power Modules General Terms and Conditions of Sale.

## Limitation of Liability

Flex Power Modules does not make any other warranties, expressed or implied including any warranty of merchantability or fitness for a particular purpose (including, but not limited to, use in life support applications, where malfunctions of product can cause

## Technical Specification

<b>PKB 4000C Series DC-DC Converters</b> <b>Input 36-75 V, Output up to 60 A / 144 W</b>	EN/LZT 146 377 R5A	November 2017
	© Flex	

injury to a person's health or life).

#### © Flex 2017

The information and specifications in this technical specification is believed to be correct at the time of publication. However, no liability is accepted for inaccuracies, printing errors or for any consequences thereof. Flex reserves the right to change the contents of this technical specification at any time without prior notice.

### Safety Specification

#### General information

Flex Power Modules DC/DC converters and DC/DC regulators are designed in accordance with the safety standards IEC 60950-1, EN 60950-1 and UL 60950-1 *Safety of Information Technology Equipment*.

IEC/EN/UL 60950-1 contains requirements to prevent injury or damage due to the following hazards:

- Electrical shock
- Energy hazards
- Fire
- Mechanical and heat hazards
- Radiation hazards
- Chemical hazards

On-board DC/DC converters, Power interface modules and DC/DC regulators are defined as component power supplies. As components they cannot fully comply with the provisions of any safety requirements without "conditions of acceptability". Clearance between conductors and between conductive parts of the component power supply and conductors on the board in the final product must meet the applicable safety requirements. Certain conditions of acceptability apply for component power supplies with limited stand-off (see Mechanical Information and Safety Certificate for further information). It is the responsibility of the installer to ensure that the final product housing these components complies with the requirements of all applicable safety standards and regulations for the final product.

Component power supplies for general use should comply with the requirements in IEC/EN/UL 60950/1 *Safety of Information Technology Equipment*. Product related standards, e.g. IEEE 802.3af *Power over Ethernet*, and ETS-300132-2 *Power interface at the input to telecom equipment, operated by direct current (dc)* are based on IEC/EN/UL 60950-1 with regards to safety.

Flex Power Modules DC/DC converters, Power interface modules and DC/DC regulators are UL 60950-1 recognized and certified in accordance with EN 60950-1. The flammability rating for all construction parts of the products meet requirements for V-0 class material according to IEC 60695-11-10, *Fire hazard testing, test flames – 50 W*

horizontal and vertical flame test methods.

#### Isolated DC/DC converters

The product may provide basic or functional insulation between input and output according to IEC/EN/UL 60950-1 (see Safety Certificate), different conditions shall be met if the output of a basic or a functional insulated product shall be considered as safety extra low voltage (SELV).

For basic insulated products (see Safety Certificate) the output is considered as safety extra low voltage (SELV) if one of the following conditions is met:

- The input source provides supplementary or double or reinforced insulation from the AC mains according to IEC/EN/UL 60950-1.
- The input source provides functional or basic insulation from the AC mains and the product's output is reliably connected to protective earth according to IEC/EN/UL 60950-1.

For functional insulated products (see Safety Certificate) the output is considered as safety extra low voltage (SELV) if one of the following conditions is met:

- The input source provides double or reinforced insulation from the AC mains according to IEC/EN/UL 60950-1.
- The input source provides basic or supplementary insulation from the AC mains and the product's output is reliably connected to protective earth according to IEC/EN/UL 60950-1.
- The input source is reliably connected to protective earth and provides basic or supplementary insulation according to IEC/EN/UL 60950-1 and the maximum input source voltage is 60 Vdc.

Galvanic isolation between input and output is verified in an electric strength test and the isolation voltage ( $V_{iso}$ ) meets the voltage strength requirement for basic insulation according to IEC/EN/UL 60950-1.

It is recommended to use a slow blow fuse at the input of each product. If an input filter is used in the circuit the fuse should be placed in front of the input filter. In the rare event of a component problem that imposes a short circuit on the input source, this fuse will provide the following functions:

- Isolate the fault from the input power source so as not to affect the operation of other parts of the system
- Protect the distribution wiring from excessive current and power loss thus preventing hazardous overheating

Technical Specification

**PKB 4000C Series DC-DC Converters**  
 Input 36-75 V, Output up to 60 A / 144 W

EN/LZT 146 377 R5A November 2017  
 © Flex

**Absolute Maximum Ratings**

Characteristics		min	typ	max	Unit
$T_{p1}$	Operating Temperature (see Thermal Consideration section)	-40		+125	°C
$T_s$	Storage temperature	-55		+125	°C
$V_i$	Input voltage	-0.5		+80	V
$V_{iso}$	Isolation voltage (input to output test voltage), see note 1			1500	Vdc
$V_{tr}$	Input voltage transient (Tp 100 ms)			100	V
$V_{RC}$	Remote Control pin voltage (see Operating Information section)	Positive logic option	0	16	V
		Negative logic option	0	16	V
$V_{adj}$	Adjust pin voltage (see Operating Information section)	-0.5		$2xV_{oi}$	V

Stress in excess of Absolute Maximum Ratings may cause permanent damage. Absolute Maximum Ratings, sometimes referred to as no destruction limits, are normally tested with one parameter at a time exceeding the limits in the Electrical Specification. If exposed to stress above these limits, function and performance may degrade in an unspecified manner.

Note 1: Isolation voltage (input/output to base-plate) max 750Vdc.

**Fundamental Circuit Diagram**

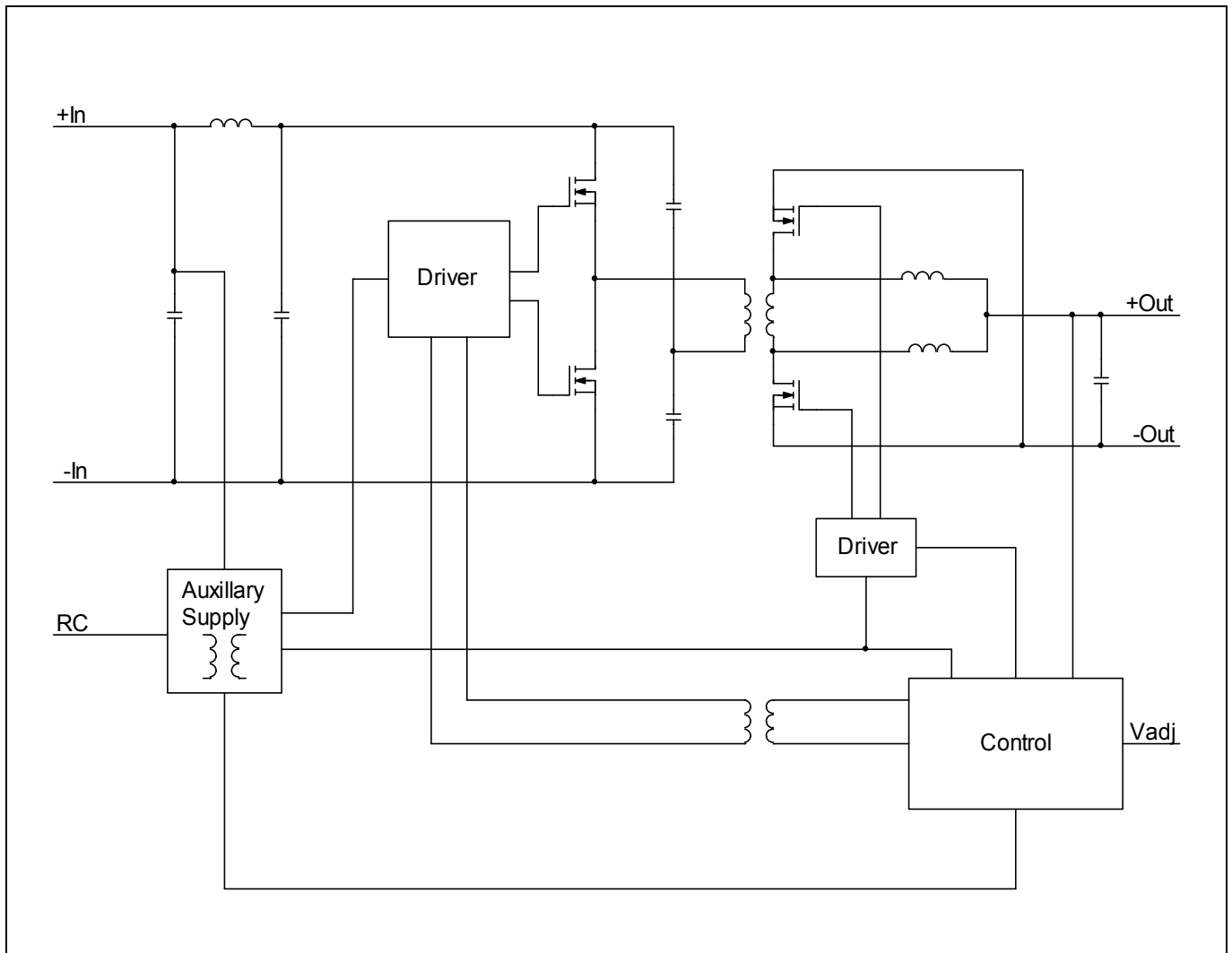

## Technical Specification

**PKB 4000C Series DC-DC Converters**  
Input 36-75 V, Output up to 60 A / 144 W

EN/LZT 146 377 R5A

November 2017

© Flex

**1 V/50 A Electrical Specification****PKB 4518NC PI**

$T_{p1} = -40$  to  $+90^{\circ}\text{C}$ ,  $V_i = 36$  to  $75$  V, sense pins connected to output pins unless otherwise specified under Conditions.

Typical values given at:  $T_{p1} = +25^{\circ}\text{C}$ ,  $V_i = 53$  V, max  $I_o$ , unless otherwise specified under Conditions.

Characteristics		Conditions	min	typ	max	Unit
$V_i$	Input voltage range		36		75	V
$V_{loff}$	Turn-off input voltage	Decreasing input voltage	29	31	34	V
$V_{lon}$	Turn-on input voltage	Increasing input voltage	30	33	36	V
$C_i$	Internal input capacitance			1		$\mu\text{F}$
$P_o$	Output power		0		50	W
$\eta$	Efficiency	50 % of max $I_o$		87		%
		max $I_o$		85.7		
		50 % of max $I_o$ , $V_i = 48$ V		87.2		
		max $I_o$ , $V_i = 48$ V		85.8		
$P_d$	Power Dissipation	max $I_o$		8.3	11.5	W
$P_{ii}$	Input idling power	$I_o = 0$ A, $V_i = 53$ V		2.1		W
$P_{RC}$	Input standby power	$V_i = 53$ V (turned off with RC)		0.07		W
$f_s$	Switching frequency	0-100 % of max $I_o$		250		kHz

$V_{oi}$	Output voltage initial setting and accuracy	$T_{p1} = +25^{\circ}\text{C}$ , $V_i = 53$ V, $I_o = 50$ A	0.98	1	1.02	V
$V_o$	Output adjust range	See operating information	0.8		1.1	V
	Output voltage tolerance band	10-100% of max $I_o$	0.97		1.03	V
	Idling voltage	$I_o = 0$ A	0.98		1.02	V
	Line regulation	max $I_o$		1	5	mV
	Load regulation	$V_i = 53$ V, 1-100% of max $I_o$		3	10	mV
$V_{tr}$	Load transient voltage deviation	$V_i = 53$ V, Load step 50-75-50 % of max $I_o$ , $di/dt = 1$ A/ $\mu\text{s}$ , see Note 2		$\pm 50$		mV
$t_{tr}$	Load transient recovery time			40		$\mu\text{s}$
$t_r$	Ramp-up time (from 10-90 % of $V_{oi}$ )	10-100% of max $I_o$		8	10	ms
$t_s$	Start-up time (from $V_i$ connection to 90% of $V_{oi}$ )	$T_{p1} = 25^{\circ}\text{C}$ , $V_i = 53$ V		12	15	ms
$t_f$	$V_{in}$ shutdown fall time (from $V_i$ off to 10% of $V_o$ )	max $I_o$		0.1		ms
		$I_o = 0$ A		13		s
$t_{RC}$	RC start-up time	max $I_o$		11		ms
	RC shutdown fall time (from RC off to 10% of $V_o$ )	max $I_o$		0.1		ms
		$I_o = 0$ A		12		s
$I_o$	Output current		0		50	A
$I_{lim}$	Current limit threshold	$V_o = 0.9$ V, $T_{p1} < \max T_{p1}$	52	56	61	A
$I_{sc}$	Short circuit current	$T_{p1} = 25^{\circ}\text{C}$ , $V_o < 0.5$ V		59		A
$V_{Oac}$	Output ripple & noise	See ripple & noise section, max $I_o$ , $V_{oi}$ , see Note 3		20	40	mVp-p
OVP	Over voltage protection	$T_{p1} = +25^{\circ}\text{C}$ , $V_i = 53$ V, 10-100% of max $I_o$		1.6		V
$V_{RC}$	ON/OFF pin Voltage to guarantee (only negative logic)	ON	see Note 4		0.8	V
		OFF		2.4		

Note 2: 2310uF capacitor in output side.

Note 3: 4\*100uF ceramic capacitor in output side.

Note 4: Refer to -In pin.

**PKB 4000C Series DC-DC Converters**  
 Input 36-75 V, Output up to 60 A / 144 W

EN/LZT 146 377 R5A

November 2017

© Flex

**1 V/50 A Typical Characteristics**

**PKB 4518NC PI**

**Efficiency**

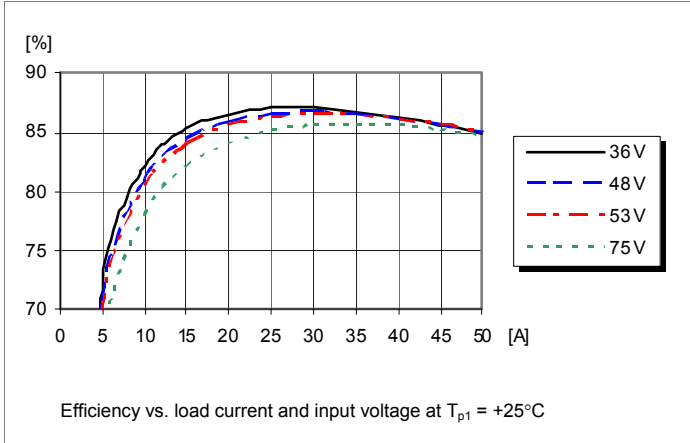

**Power Dissipation**

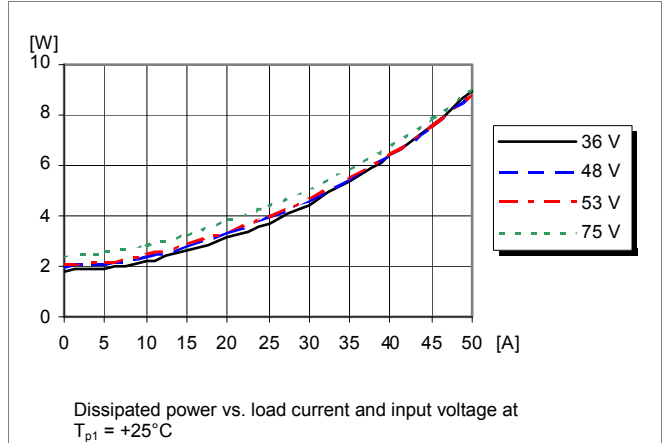

**Output Characteristics**

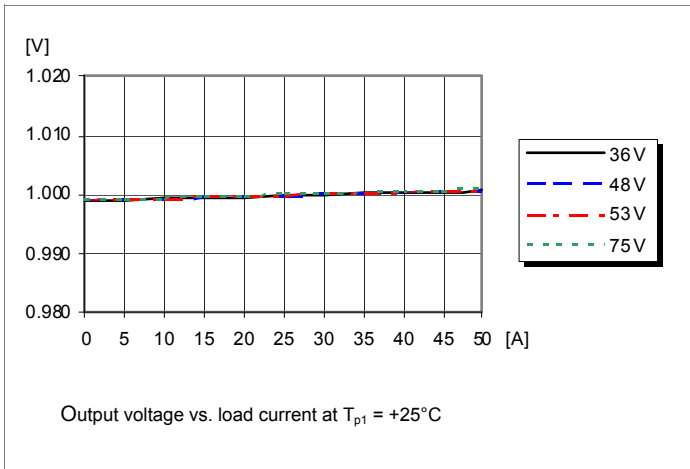

**Current Limit Characteristics**

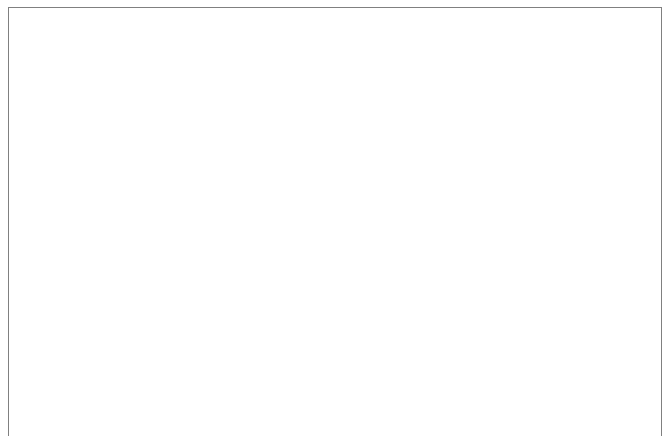
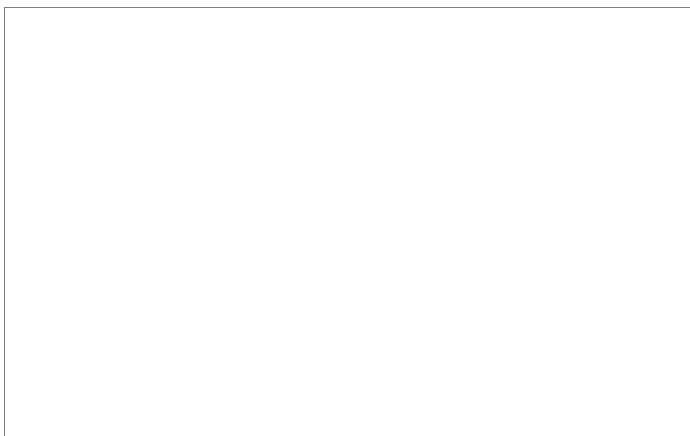
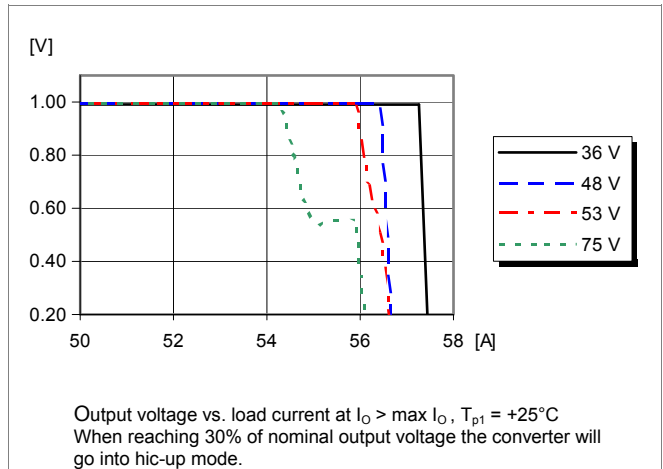

## Technical Specification

**PKB 4000C Series DC-DC Converters**  
 Input 36-75 V, Output up to 60 A / 144 W

EN/LZT 146 377 R5A

November 2017

© Flex

### 1 V/50 A Typical Characteristics

### PKB 4518NC PI

#### Start-up

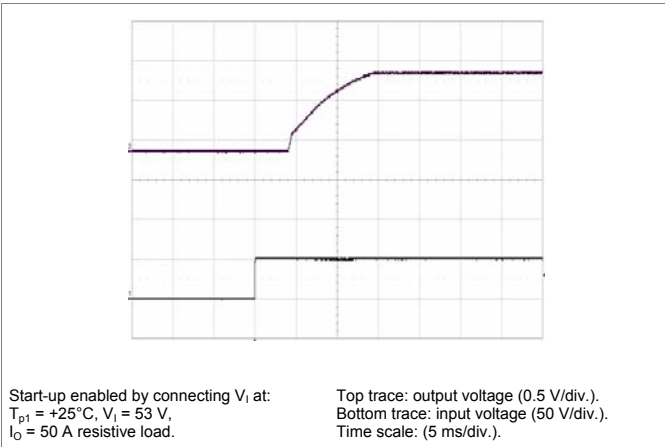

#### Shut-down

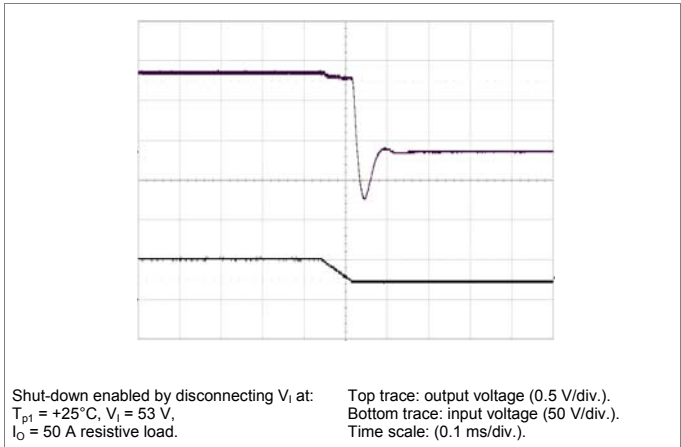

#### Output Ripple & Noise

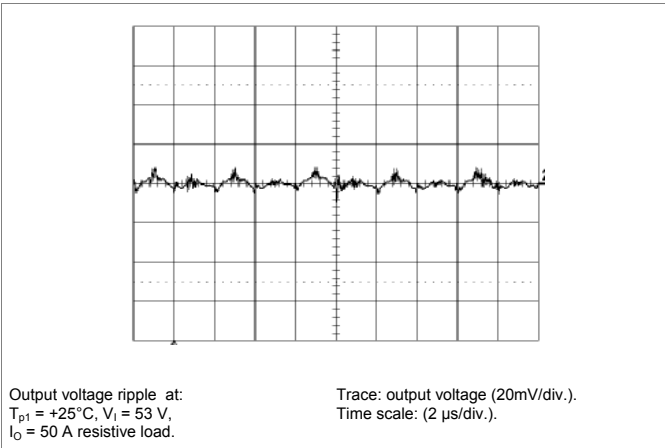

#### Output Load Transient Response

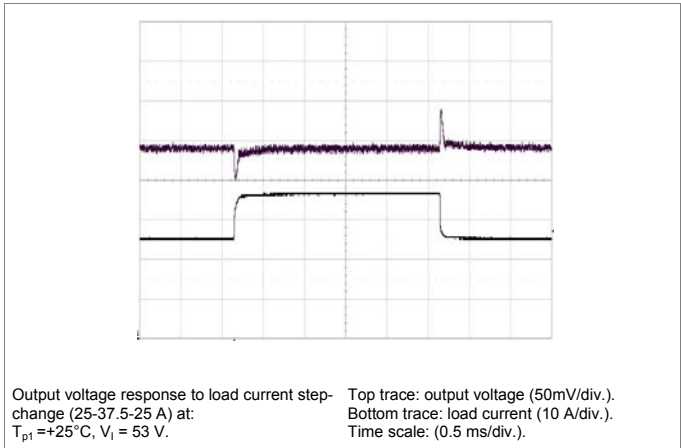

### Output Voltage Adjust (see operating information)

#### Passive adjust

The resistor value for an adjusted output voltage is calculated by using the following equations:

Output Voltage Adjust Upwards, Increase:

$$R_{adj} = \left( \frac{5.11 \times 1.0 (100 + \Delta\%)}{0.6215 \times \Delta\%} - \frac{511}{\Delta\%} - 10.22 \right) \text{ k}\Omega$$

Example: Increase 4%  $\Rightarrow V_{out} = 1.04\text{ Vdc}$

$$\left( \frac{5.11 \times 1.0 (100 + 4)}{0.6215 \times 4} - \frac{511}{4} - 10.22 \right) \text{ k}\Omega = 78.9 \text{ k}\Omega$$

Output Voltage Adjust Downwards, Decrease:

$$R_{adj} = \left( \frac{511}{\Delta\%} - 10.22 \right) \text{ k}\Omega$$

Example: Decrease 2%  $\Rightarrow V_{out} = 0.98\text{ Vdc}$

$$\left( \frac{511}{2} - 10.22 \right) \text{ k}\Omega = 245 \text{ k}\Omega$$

**PKB 4000C Series DC-DC Converters**  
 Input 36-75 V, Output up to 60 A / 144 W

EN/LZT 146 377 R5A November 2017  
 © Flex

**1 V/50 A Typical Characteristics**

**PKB 4518NC PI**

**Output Current Derating – Open frame**

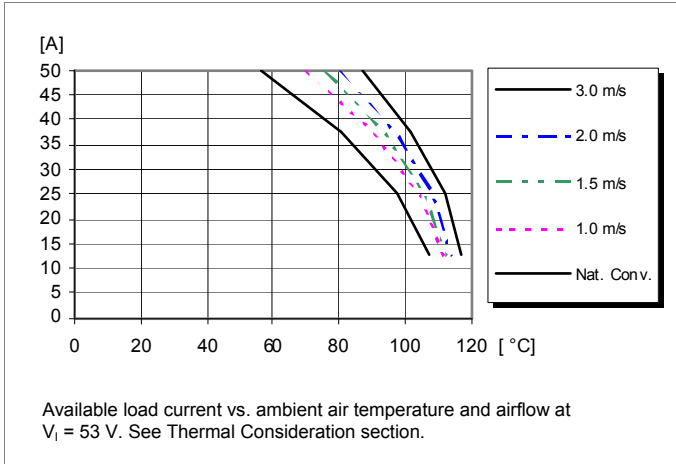

**Thermal Resistance - Open frame**

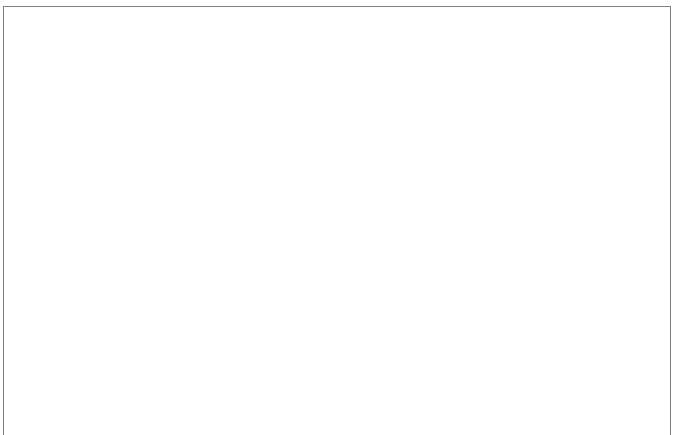
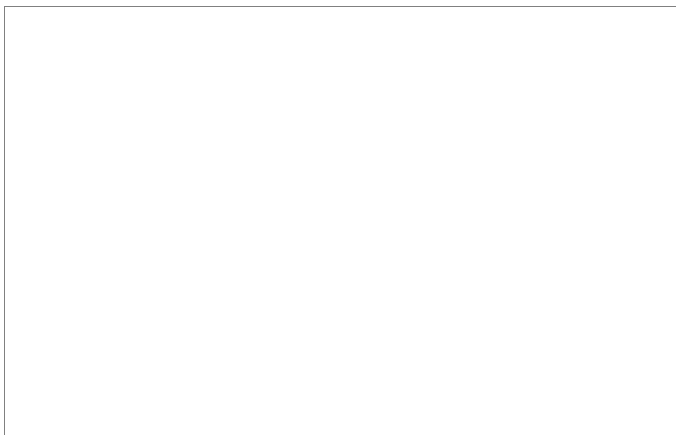
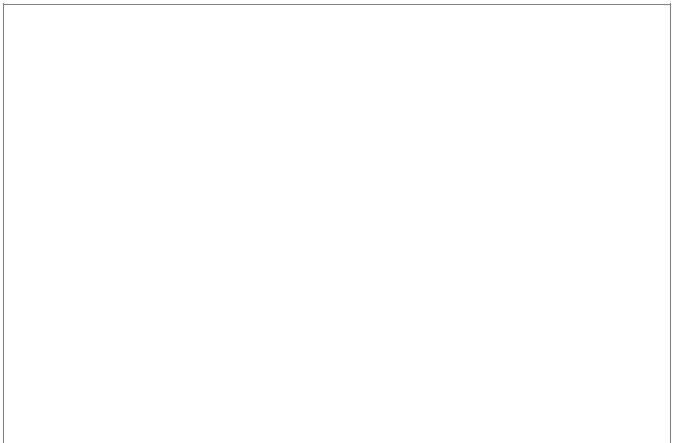
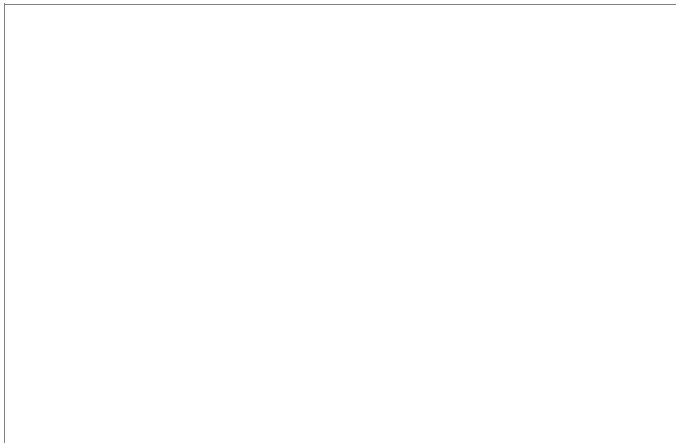
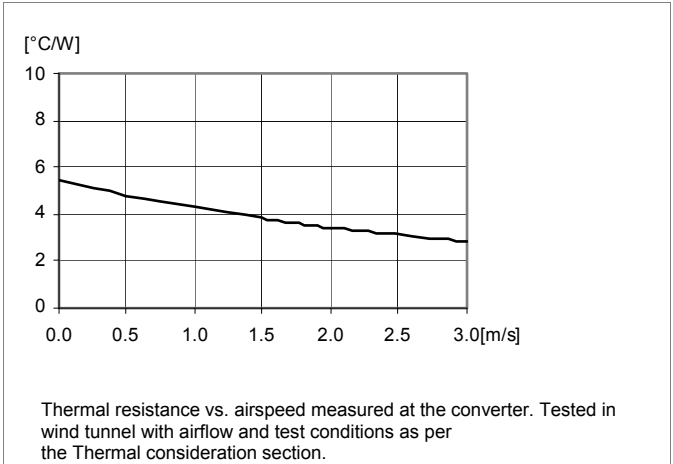

## Technical Specification

**PKB 4000C Series DC-DC Converters**  
 Input 36-75 V, Output up to 60 A / 144 W

EN/LZT 146 377 R5A

November 2017

© Flex

**1.2 V/60 A Electrical Specification**
**PKB 4718LC PI**

$T_{p1} = -40$  to  $+90^{\circ}\text{C}$ ,  $V_I = 36$  to  $75$  V, sense pins connected to output pins unless otherwise specified under Conditions.  
 Typical values given at:  $T_{p1} = +25^{\circ}\text{C}$ ,  $V_I = 53$  V, max  $I_O$ , unless otherwise specified under Conditions.

Characteristics		Conditions	min	typ	max	Unit
$V_I$	Input voltage range		36		75	V
$V_{loff}$	Turn-off input voltage	Decreasing input voltage	29	31	33	V
$V_{lon}$	Turn-on input voltage	Increasing input voltage	30	33	36	V
$C_I$	Internal input capacitance			1		$\mu\text{F}$
$P_O$	Output power		0		72	W
$\eta$	Efficiency	50 % of max $I_O$		87.5		%
		max $I_O$		86		
		50 % of max $I_O$ , $V_I = 48$ V		88		
		max $I_O$ , $V_I = 48$ V		86		
$P_d$	Power Dissipation	max $I_O$		12.2	15.9	W
$P_{ii}$	Input idling power	$I_O = 0$ A, $V_I = 53$ V		2.5		W
$P_{RC}$	Input standby power	$V_I = 53$ V (turned off with RC)		74		mW
$f_s$	Switching frequency	0-100 % of max $I_O$		250		kHz

$V_{Oi}$	Output voltage initial setting and accuracy	$T_{p1} = +25^{\circ}\text{C}$ , $V_I = 53$ V, $I_O = 60$ A	1.176	1.2	1.224	V
$V_O$	Output adjust range	See operating information	0.96		1.32	V
	Output voltage tolerance band	10-100% of max $I_O$	1.17		1.23	V
	Idling voltage	$I_O = 0$ A	1.17		1.23	V
	Line regulation	max $I_O$		0	5	mV
	Load regulation	$V_I = 53$ V, 1-100% of max $I_O$		0	5	mV
$V_{tr}$	Load transient voltage deviation	$V_I = 53$ V, Load step 25-75-25 % of max $I_O$ , $di/dt = 1$ A/ $\mu\text{s}$ , see Note 1		$\pm 200$		mV
$t_{tr}$	Load transient recovery time			50		$\mu\text{s}$
$t_r$	Ramp-up time (from 10-90 % of $V_{Oi}$ )	10-100% of max $I_O$		8	11	ms
$t_s$	Start-up time (from $V_I$ connection to 90% of $V_{Oi}$ )	$T_{p1} = 25^{\circ}\text{C}$ , $V_I = 53$ V		13	18	ms
$t_f$	$V_{in}$ shutdown fall time (from $V_I$ off to 10% of $V_O$ )	max $I_O$		0.1		ms
		$I_O = 0$ A		13		s
$t_{RC}$	RC start-up time	max $I_O$		11		ms
	RC shutdown fall time (from RC off to 10% of $V_O$ )	max $I_O$		0.2		ms
		$I_O = 0$ A		8		s
$I_O$	Output current		0		60	A
$I_{lim}$	Current limit threshold	$V_O = 1.1V$ , $T_{p1} < \text{max } T_{p1}$	61	65	81	A
$I_{sc}$	Short circuit current	$T_{p1} = 25^{\circ}\text{C}$ , $V_O < 0.2V$ , see Note 2		75		A
$V_{Oac}$	Output ripple & noise	See ripple & noise section, max $I_O$ , $V_{Oi}$		40	120	mVp-p
OVP	Over voltage protection	$T_{p1} = +25^{\circ}\text{C}$ , $V_I = 53$ V, 10-100% of max $I_O$		1.56		V

Note 1: Output filter according to Ripple & Noise section.

Note 2: RMS current in hiccup mode.

**PKB 4000C Series DC-DC Converters**  
 Input 36-75 V, Output up to 60 A / 144 W

EN/LZT 146 377 R5A

November 2017

© Flex

**1.2 V/60 A Typical Characteristics**

**PKB 4718LC PI**

**Efficiency**

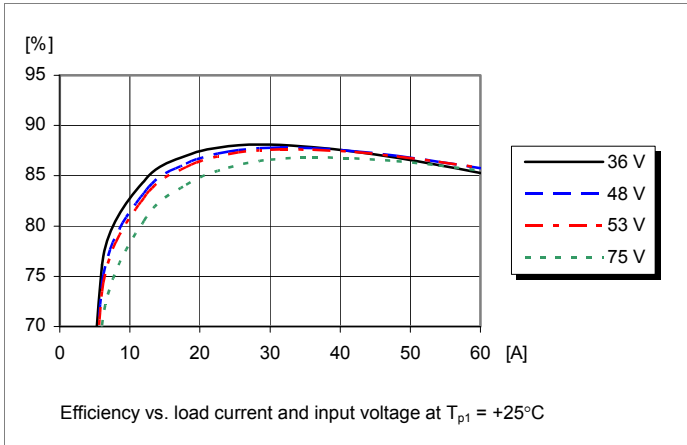

**Power Dissipation**

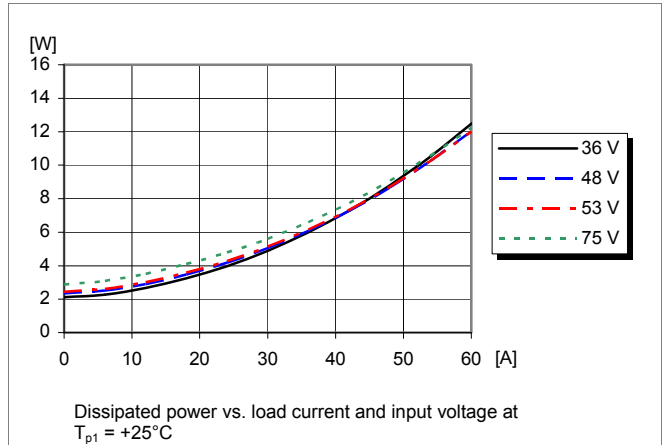

**Output Characteristics**

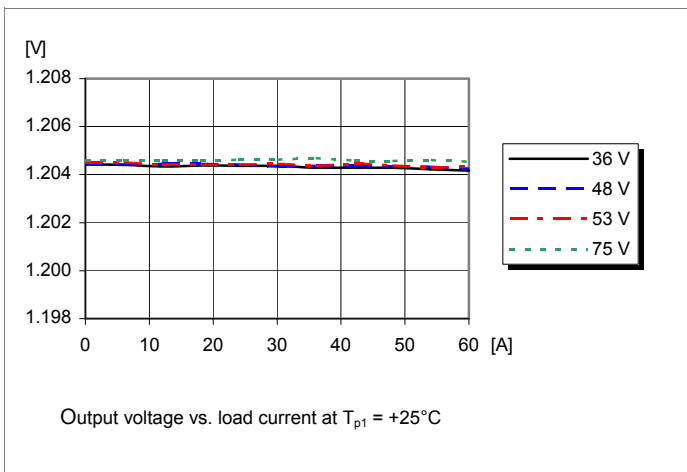

**Current Limit Characteristics**

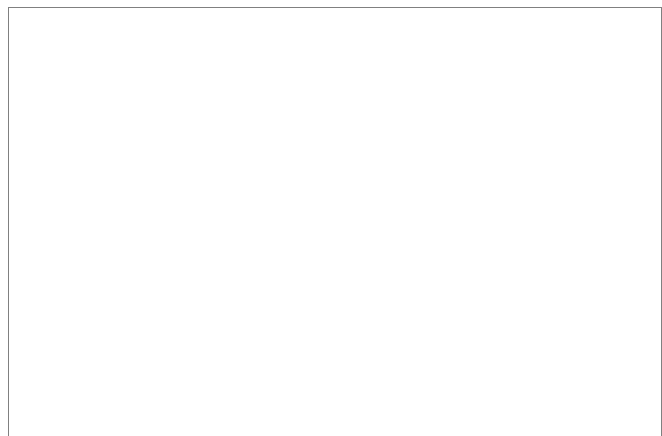
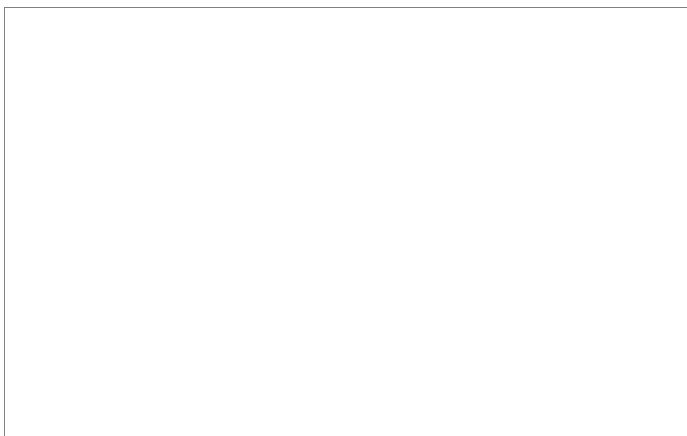
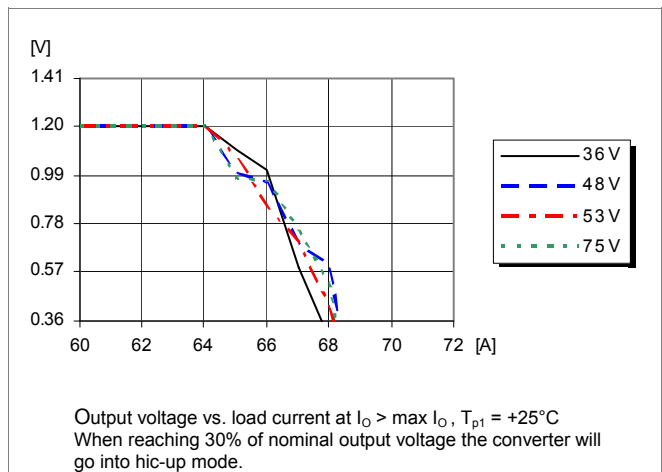

**PKB 4000C Series DC-DC Converters**  
 Input 36-75 V, Output up to 60 A / 144 W

EN/LZT 146 377 R5A

November 2017

© Flex

### 1.2 V/60 A Typical Characteristics

### PKB 4718LC PI

#### Start-up

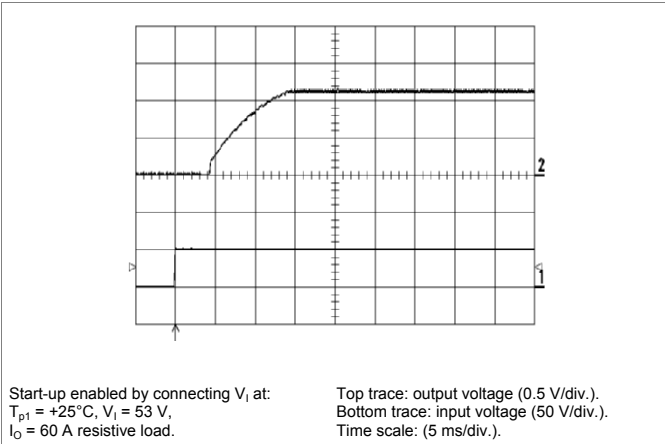

#### Shut-down

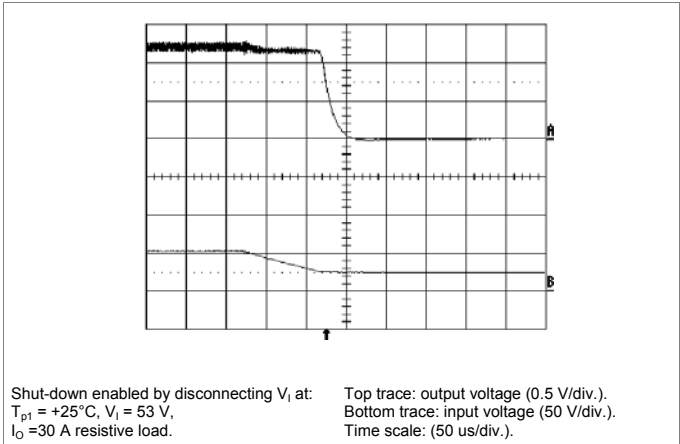

#### Output Ripple & Noise

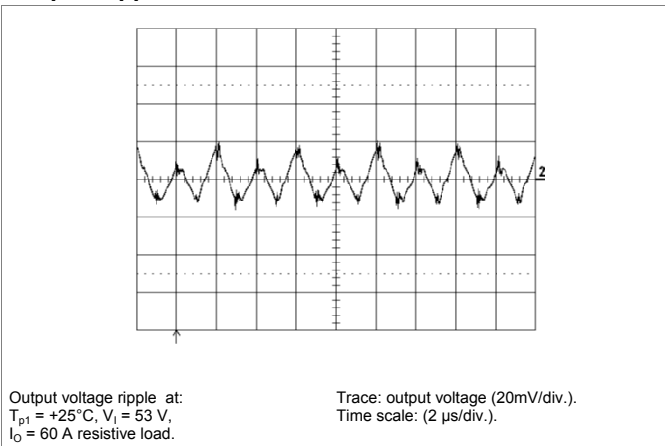

#### Output Load Transient Response

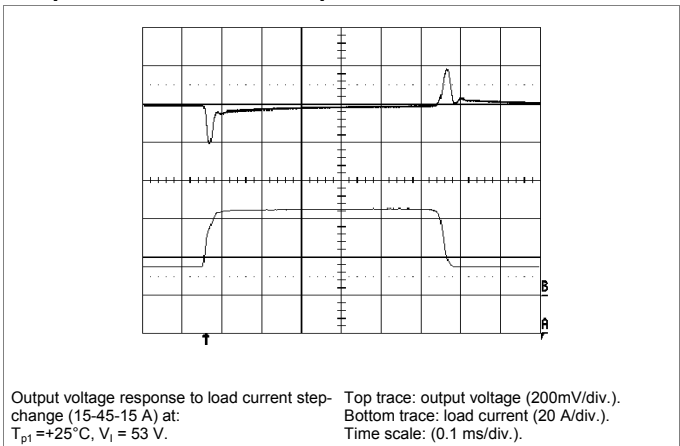

#### Output Voltage Adjust (see operating information)

##### Passive adjust

The resistor value for an adjusted output voltage is calculated by using the following equations:

Output Voltage Adjust Upwards, Increase:

$$R_{adj} = 5.11 \times \left( \frac{1.2 \times (100 + \Delta\%) - (100 + 2 \times \Delta\%)}{0.62 \times \Delta\%} - \frac{(100 + 2 \times \Delta\%)}{\Delta\%} \right) \text{ k}\Omega$$

Example: Increase 4%  $\Rightarrow V_{out} = 1.248\text{ Vdc}$

$$5.11 \times \left( \frac{1.2 \times (100 + 4) - (100 + 2 \times 4)}{0.62 \times 4} - \frac{(100 + 2 \times 4)}{4} \right) \text{ k}\Omega = 119\text{ k}\Omega$$

Output Voltage Adjust Downwards, Decrease:

$$R_{adj} = 5.11 \times \left( \frac{100}{\Delta\%} - 2 \right) \text{ k}\Omega$$

Example: Decrease 2%  $\Rightarrow V_{out} = 1.176\text{ Vdc}$

$$5.11 \times \left( \frac{100}{2} - 2 \right) \text{ k}\Omega = 245\text{ k}\Omega$$

**PKB 4000C Series DC-DC Converters**  
 Input 36-75 V, Output up to 60 A / 144 W

EN/LZT 146 377 R5A November 2017  
 © Flex

**1.2 V/60 A Typical Characteristics**

**PKB 4718LC PI**

**Output Current Derating – Open frame**

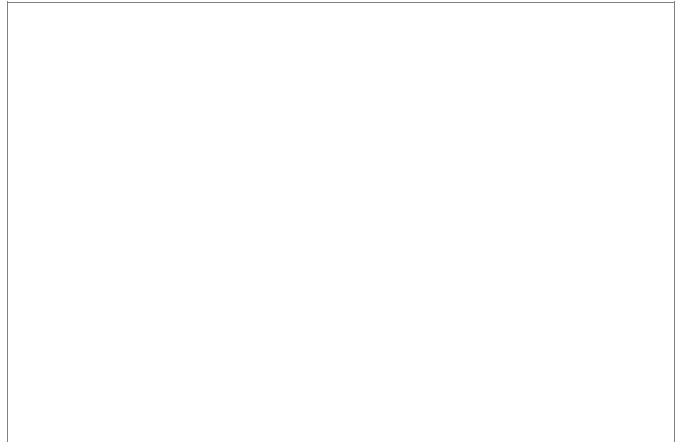
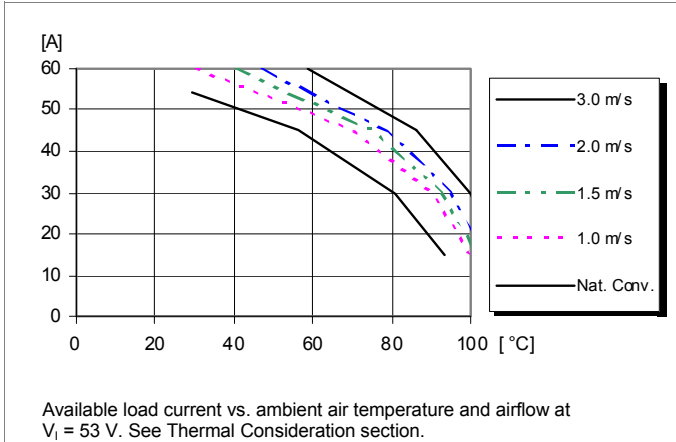

**Output Current Derating – Base Plate**

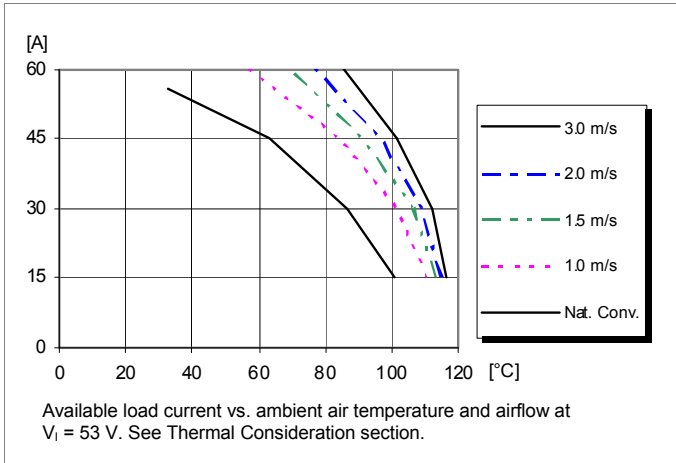

**Thermal Resistance – Base plate**

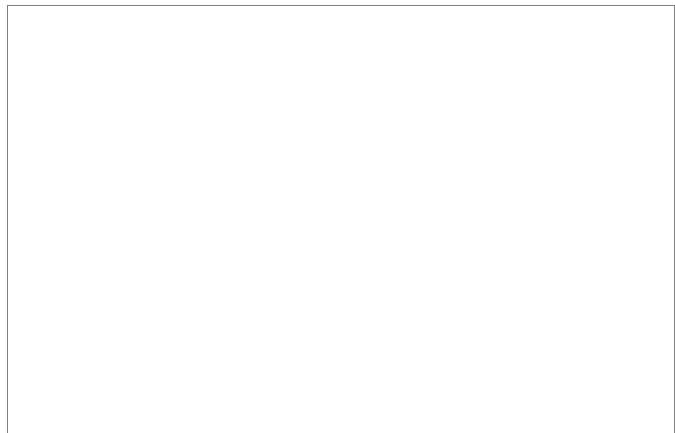
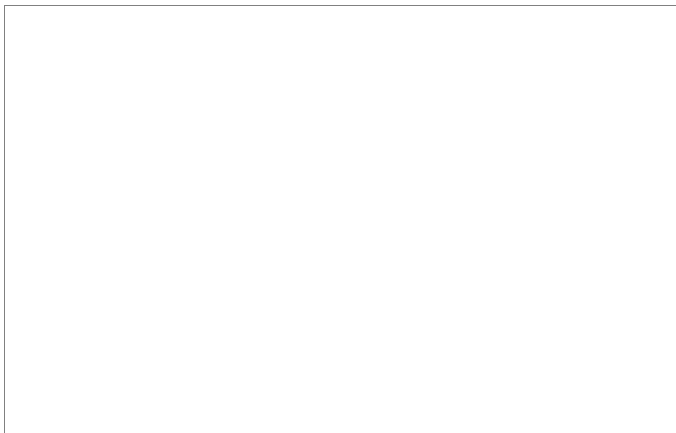
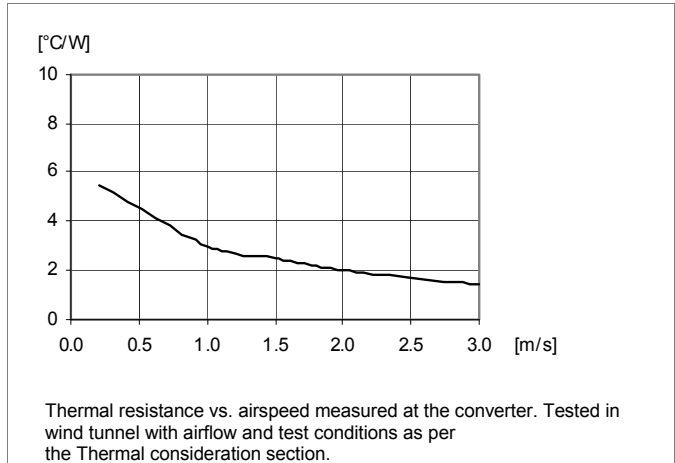

## Technical Specification

**PKB 4000C Series DC-DC Converters**  
 Input 36-75 V, Output up to 60 A / 144 W

EN/LZT 146 377 R5A

November 2017

© Flex

**1.5 V/60 A Electrical Specification**
**PKB 4918HC PI**
 $T_{p1} = -40$  to  $+90^{\circ}\text{C}$ ,  $V_I = 36$  to  $75$  V, sense pins connected to output pins unless otherwise specified under Conditions.

 Typical values given at:  $T_{p1} = +25^{\circ}\text{C}$ ,  $V_I = 53$  V, max  $I_O$ , unless otherwise specified under Conditions.

Characteristics		Conditions	min	typ	max	Unit
$V_I$	Input voltage range		36		75	V
$V_{Ioff}$	Turn-off input voltage	Decreasing input voltage	29	32	35	V
$V_{Ion}$	Turn-on input voltage	Increasing input voltage	30	33	36	V
$C_I$	Internal input capacitance			1		$\mu\text{F}$
$P_O$	Output power		0		90	W
$\eta$	Efficiency	50 % of max $I_O$		88		%
		max $I_O$		87		
		50 % of max $I_O$ , $V_I = 48$ V		88.5		
		max $I_O$ , $V_I = 48$ V		87		
$P_d$	Power Dissipation	max $I_O$		14.1	15.9	W
$P_{ii}$	Input idling power	$I_O = 0$ A, $V_I = 53$ V		3.2		W
$P_{RC}$	Input standby power	$V_I = 53$ V (turned off with RC)		99		mW
$f_s$	Switching frequency	0-100 % of max $I_O$		250		kHz

$V_{Oi}$	Output voltage initial setting and accuracy	$T_{p1} = +25^{\circ}\text{C}$ , $V_I = 53$ V, $I_O = 60$ A	1.47	1.5	1.53	V
$V_O$	Output adjust range	See operating information	1.20		1.65	V
	Output voltage tolerance band	10-100% of max $I_O$	1.47		1.53	V
	Idling voltage	$I_O = 0$ A	1.47		1.53	V
	Line regulation	max $I_O$		1	5	mV
	Load regulation	$V_I = 53$ V, 1-100% of max $I_O$		10	15	mV
$V_{tr}$	Load transient voltage deviation	$V_I = 53$ V, Load step 25-75-25 % of max $I_O$ , $di/dt = 1$ A/ $\mu\text{s}$ , see Note 1		$\pm 180$		mV
$t_{tr}$	Load transient recovery time			110		$\mu\text{s}$
$t_r$	Ramp-up time (from 10-90 % of $V_{Oi}$ )	10-100% of max $I_O$		8	11	ms
$t_s$	Start-up time (from $V_I$ connection to 90% of $V_{Oi}$ )	$T_{p1} = 25^{\circ}\text{C}$ , $V_I = 53$ V		13	18	ms
$t_f$	$V_{in}$ shutdown fall time (from $V_{Ioff}$ to 10% of $V_{Oi}$ )	max $I_O$		21		$\mu\text{s}$
		$I_O = 0.2$ A		48		ms
$t_{RC}$	RC start-up time	max $I_O$		12		ms
	RC shutdown fall time (from RC off to 10% of $V_{Oi}$ )	max $I_O$		10		$\mu\text{s}$
		$I_O = 0.2$ A		48		ms
$I_O$	Output current		0		60	A
$I_{lim}$	Current limit threshold	$V_O = 1.4$ V, $T_{p1} < \max T_{p1}$	64	66	68	A
$I_{sc}$	Short circuit current	$T_{p1} = 25^{\circ}\text{C}$ , $V_O < 0.2$ V, see Note 2		70		A
$V_{Oac}$	Output ripple & noise	See ripple & noise section, max $I_O$ , $V_{Oi}$		40	120	mVp-p
OVP	Over voltage protection	$T_{p1} = +25^{\circ}\text{C}$ , $V_I = 53$ V, 10-100% of max $I_O$		1.95		V

Note 1: Output filter according to Ripple &amp; Noise section.

Note 2: RMS current in hiccup mode.

Technical Specification

**PKB 4000C Series DC-DC Converters**  
 Input 36-75 V, Output up to 60 A / 144 W

EN/LZT 146 377 R5A

November 2017

© Flex

**1.5 V/60 A Typical Characteristics**

**PKB 4918HC PI**

**Efficiency**

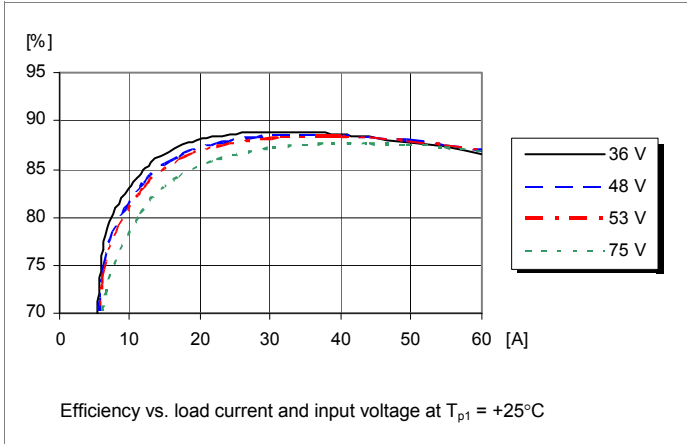

**Power Dissipation**

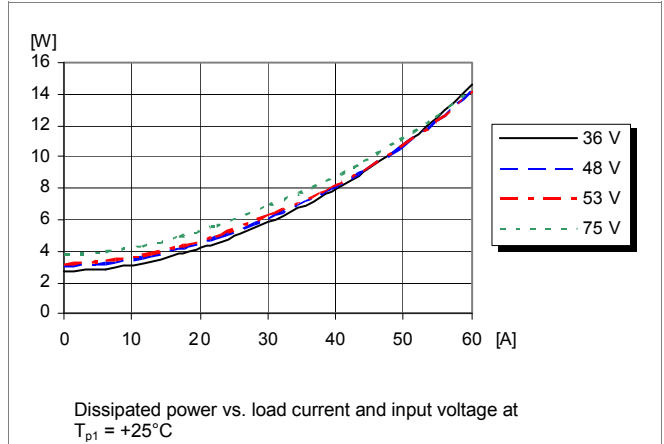

**Output Characteristics**

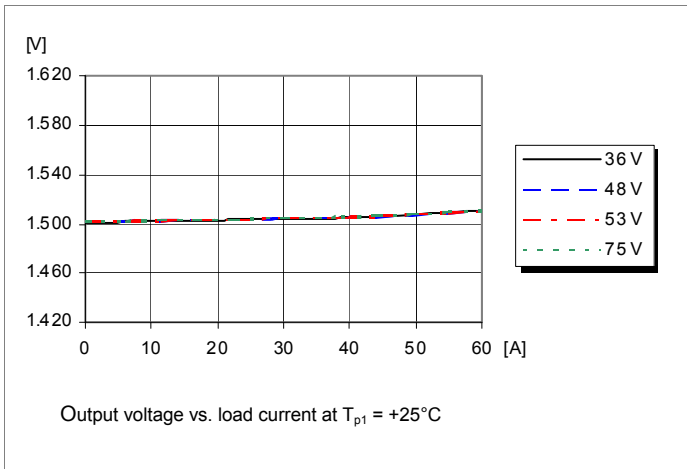

**Current Limit Characteristics**

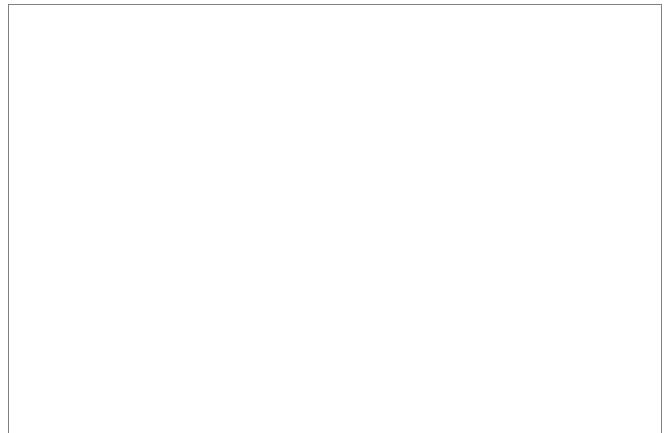
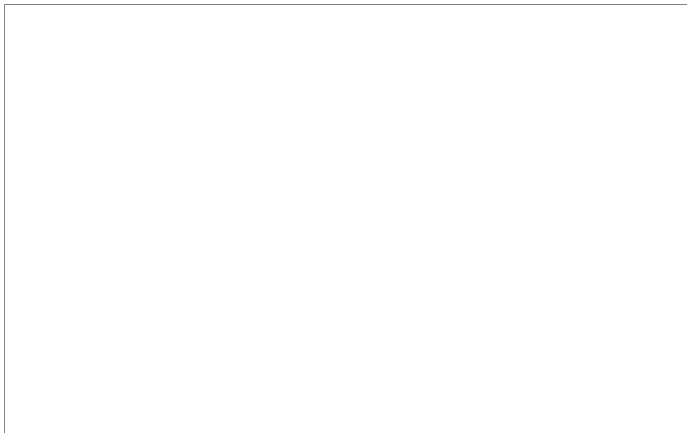
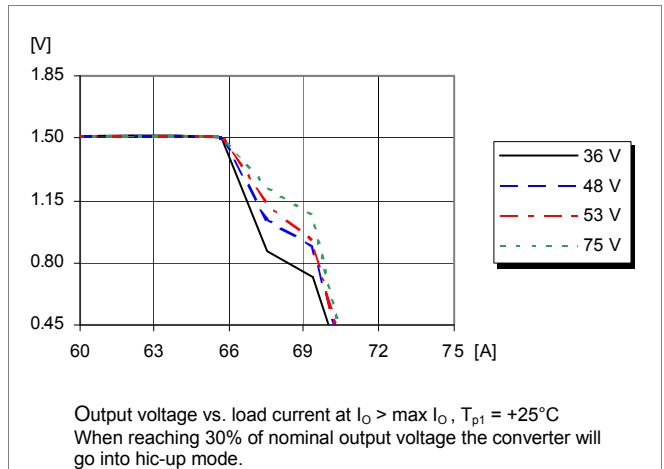

**PKB 4000C Series DC-DC Converters**  
 Input 36-75 V, Output up to 60 A / 144 W

EN/LZT 146 377 R5A November 2017  
 © Flex

### 1.5 V/60 A Typical Characteristics

### PKB 4918HC PI

#### Start-up

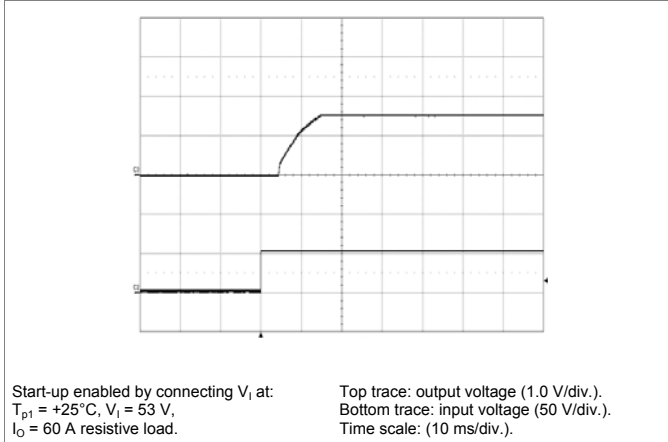

#### Shut-down

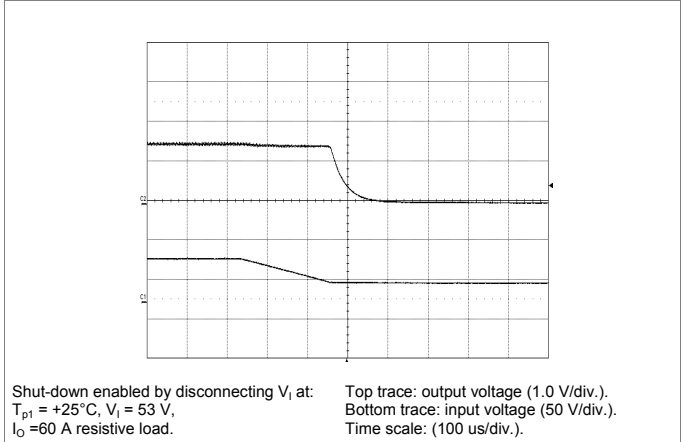

#### Output Ripple & Noise

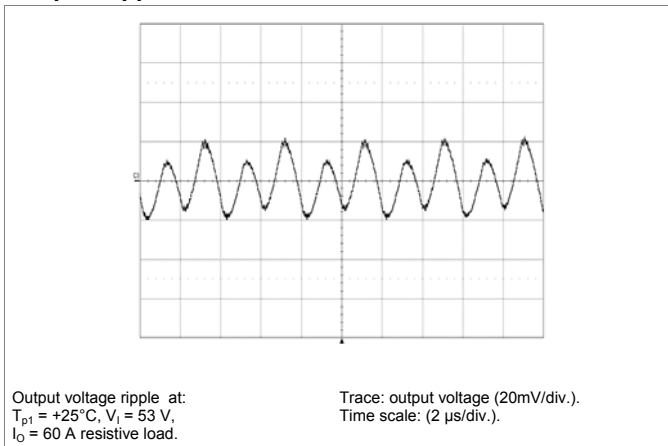

#### Output Load Transient Response

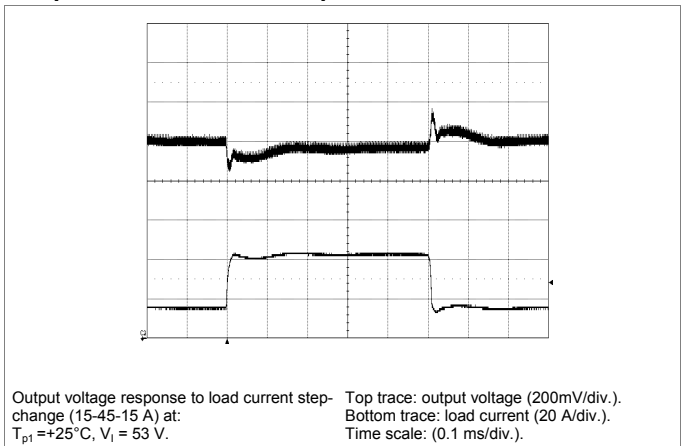

#### Output Voltage Adjust (see operating information)

##### Passive adjust

The resistor value for an adjusted output voltage is calculated by using the following equations:

Output Voltage Adjust Upwards, Increase:

$$R_{adj} = 5.11 \times \left( \frac{1.5 \times (100 + \Delta\%)}{0.62 \times \Delta\%} - \frac{(100 + 2 \times \Delta\%)}{\Delta\%} \right) \text{ k}\Omega$$

Example: Increase 4%  $\Rightarrow V_{out} = 1.56\text{ Vdc}$

$$5.11 \times \left( \frac{1.5 \times (100 + 4)}{0.62 \times 4} - \frac{(100 + 2 \times 4)}{4} \right) \text{ k}\Omega = 183 \text{ k}\Omega$$

Output Voltage Adjust Downwards, Decrease:

$$R_{adj} = 5.11 \times \left( \frac{100}{\Delta\%} - 2 \right) \text{ k}\Omega$$

Example: Decrease 2%  $\Rightarrow V_{out} = 1.47\text{ Vdc}$

$$5.11 \times \left( \frac{100}{2} - 2 \right) \text{ k}\Omega = 245 \text{ k}\Omega$$

**PKB 4000C Series DC-DC Converters**  
 Input 36-75 V, Output up to 60 A / 144 W

EN/LZT 146 377 R5A

November 2017

© Flex

**1.5 V/60 A Typical Characteristics**

**PKB 4918HC PI**

**Output Current Derating – Open frame**

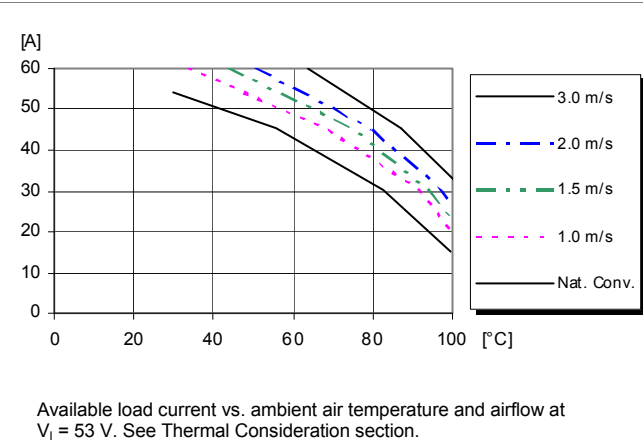

**Output Current Derating – Base plate**

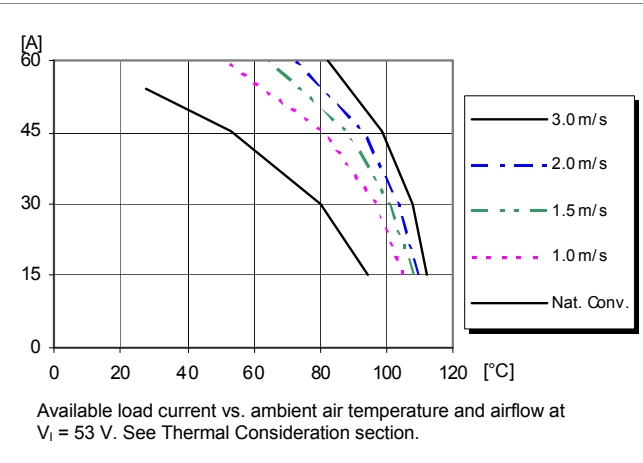

**Thermal Resistance – Base plate**

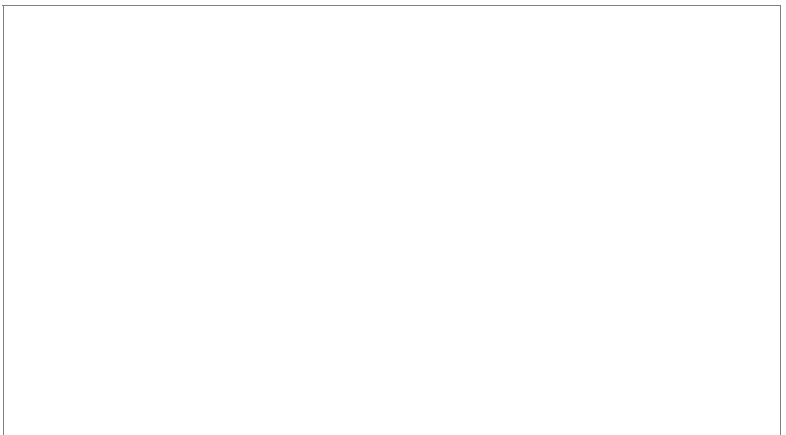
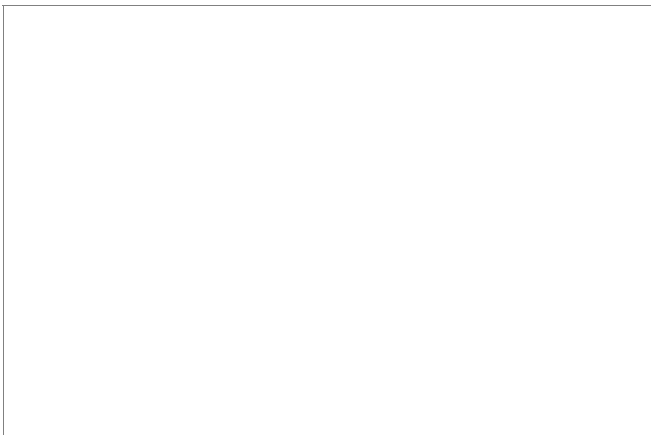
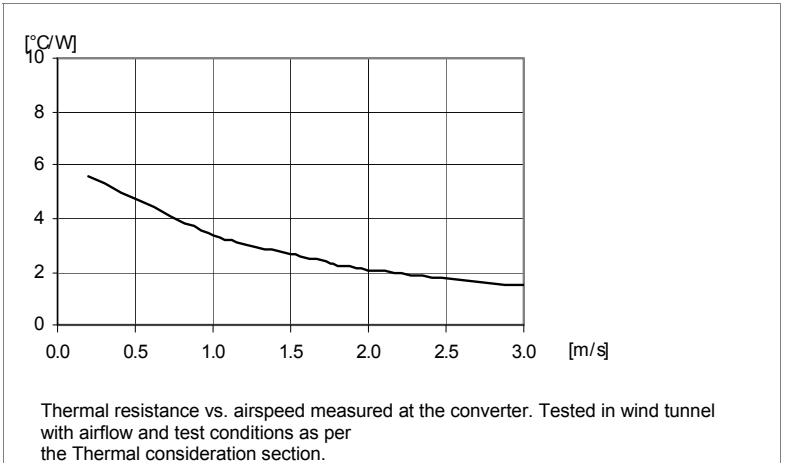

## Technical Specification

**PKB 4000C Series DC-DC Converters**  
 Input 36-75 V, Output up to 60 A / 144 W

EN/LZT 146 377 R5A

November 2017

© Flex

**1.8 V/60 A Electrical Specification**
**PKB 4118GC PI**
 $T_{p1} = -40$  to  $+90^{\circ}\text{C}$ ,  $V_I = 36$  to  $75$  V, sense pins connected to output pins unless otherwise specified under Conditions.

 Typical values given at:  $T_{p1} = +25^{\circ}\text{C}$ ,  $V_I = 53$  V, max  $I_O$ , unless otherwise specified under Conditions.

Characteristics		Conditions	min	typ	max	Unit
$V_I$	Input voltage range		36		75	V
$V_{Ioff}$	Turn-off input voltage	Decreasing input voltage	29	32	35	V
$V_{Ion}$	Turn-on input voltage	Increasing input voltage	30	33	36	V
$C_I$	Internal input capacitance			1		$\mu\text{F}$
$P_O$	Output power		0		108	W
$\eta$	Efficiency	50 % of max $I_O$		89		%
		max $I_O$		88		
		50 % of max $I_O$ , $V_I = 48$ V		89.5		
		max $I_O$ , $V_I = 48$ V		88		
$P_d$	Power Dissipation	max $I_O$		14.7	16.8	W
$P_{ii}$	Input idling power	$I_O = 0$ A, $V_I = 53$ V		3.5		W
$P_{RC}$	Input standby power	$V_I = 53$ V (turned off with RC)		82		mW
$f_s$	Switching frequency	0-100 % of max $I_O$		250		kHz

$V_{Oi}$	Output voltage initial setting and accuracy	$T_{p1} = +25^{\circ}\text{C}$ , $V_I = 53$ V, $I_O = 60$ A	1.76	1.8	1.84	V
$V_O$	Output adjust range	See operating information	1.44		1.98	V
	Output voltage tolerance band	10-100% of max $I_O$	1.76		1.84	V
	Idling voltage	$I_O = 0$ A	1.76		1.84	V
	Line regulation	max $I_O$		1	5	mV
	Load regulation	$V_I = 53$ V, 1-100% of max $I_O$		10	15	mV
$V_{tr}$	Load transient voltage deviation	$V_I = 53$ V, Load step 25-75-25 % of max $I_O$ , $di/dt = 1$ A/ $\mu\text{s}$ , see Note 1		$\pm 180$		mV
$t_{tr}$	Load transient recovery time			120		$\mu\text{s}$
$t_r$	Ramp-up time (from 10-90 % of $V_{Oi}$ )	10-100% of max $I_O$		8	11	ms
$t_s$	Start-up time (from $V_I$ connection to 90% of $V_{Oi}$ )	$T_{p1} = 25^{\circ}\text{C}$ , $V_I = 53$ V		13	18	ms
$t_f$	$V_{in}$ shutdown fall time (from $V_{Ioff}$ to 10% of $V_{Oi}$ )	max $I_O$		35		$\mu\text{s}$
		$I_O = 0.2$ A		9		ms
$t_{RC}$	RC start-up time	max $I_O$		11		ms
	RC shutdown fall time (from RC off to 10% of $V_{Oi}$ )	max $I_O$		35		$\mu\text{s}$
		$I_O = 0.2$ A		9		ms
$I_O$	Output current		0		60	A
$I_{lim}$	Current limit threshold	$V_O = 1.7\text{V}$ , $T_{p1} < \text{max } T_{p1}$	64	66	68	A
$I_{sc}$	Short circuit current	$T_{p1} = 25^{\circ}\text{C}$ , $V_O < 0.2\text{V}$ , see Note 2		72		A
$V_{Oac}$	Output ripple & noise	See ripple & noise section, max $I_O$ , $V_{Oi}$		40	120	mVp-p
OVP	Over voltage protection	$T_{p1} = +25^{\circ}\text{C}$ , $V_I = 53$ V, 10-100% of max $I_O$		2.34		V

Note 1: Output filter according to Ripple &amp; Noise section.

Note 2: RMS current in hiccup mode.

Technical Specification

**PKB 4000C Series DC-DC Converters**  
 Input 36-75 V, Output up to 60 A / 144 W

EN/LZT 146 377 R5A

November 2017

© Flex

**1.8 V/60 A Typical Characteristics**

**PKB 4118GC PI**

**Efficiency**

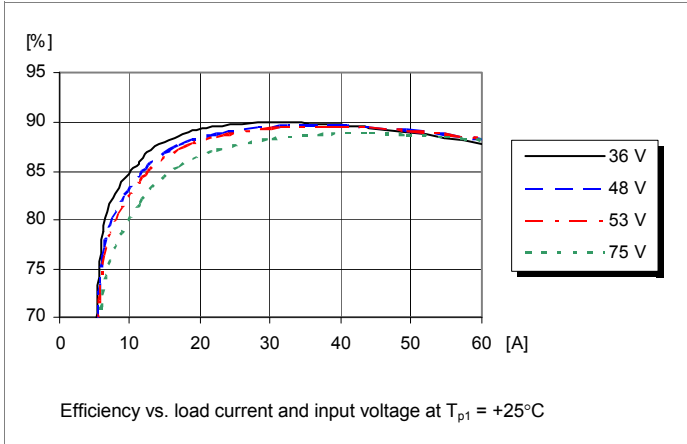

**Power Dissipation**

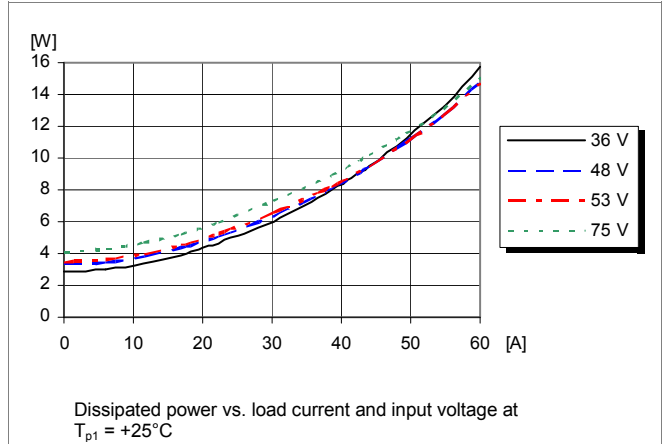

**Output Characteristics**

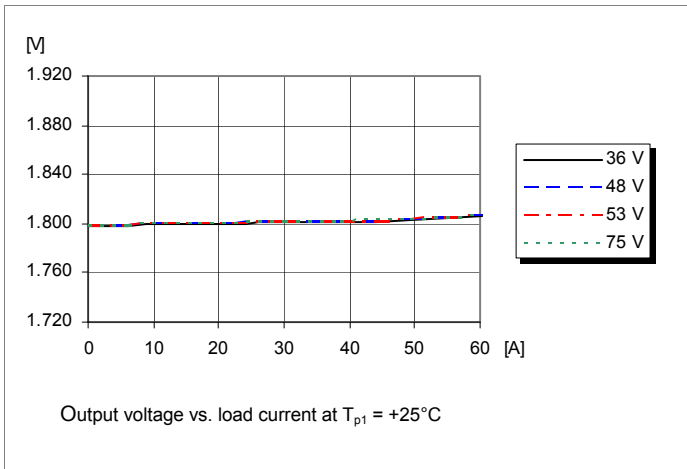

**Current Limit Characteristics**

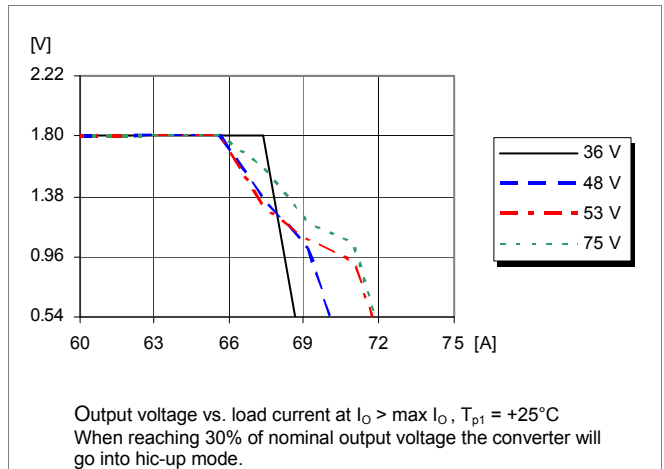

**PKB 4000C Series DC-DC Converters**  
 Input 36-75 V, Output up to 60 A / 144 W

EN/LZT 146 377 R5A

November 2017

© Flex

### 1.8 V/60 A Typical Characteristics

**PKB 4118GC PI**

#### Start-up

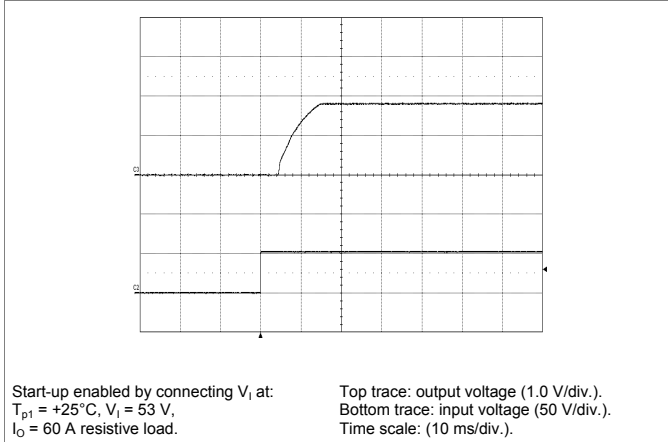

#### Shut-down

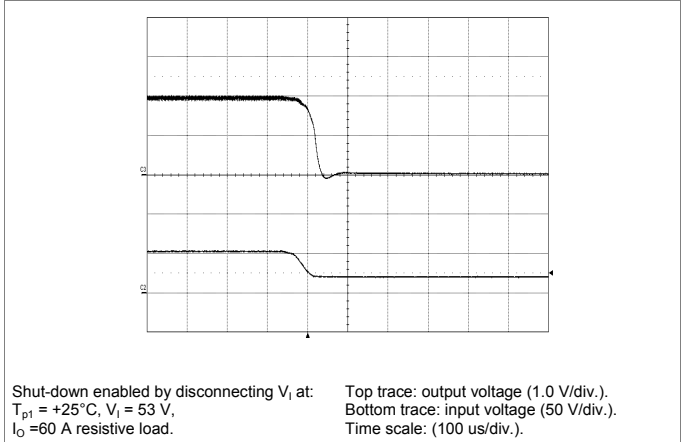

#### Output Ripple & Noise

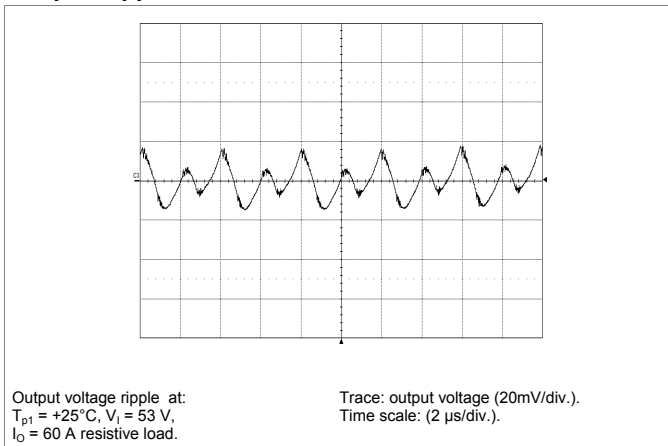

#### Output Load Transient Response

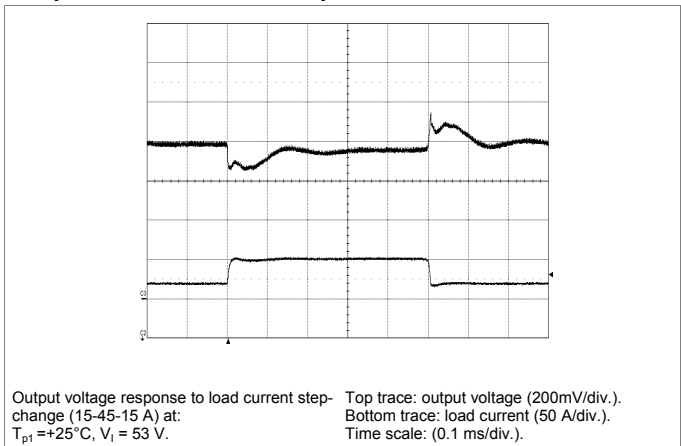

### Output Voltage Adjust (see operating information)

#### Passive adjust

The resistor value for an adjusted output voltage is calculated by using the following equations:

Output Voltage Adjust Upwards, Increase:

$$R_{adj} = 5.11 \times \left( \frac{1.8 \times (100 + \Delta\%)}{0.62 \times \Delta\%} - \frac{(100 + 2 \times \Delta\%)}{\Delta\%} \right) \text{ k}\Omega$$

Example: Increase 4% =>  $V_{out} = 1.872 \text{ Vdc}$

$$5.11 \times \left( \frac{1.8 \times (100 + 4)}{0.62 \times 4} - \frac{(100 + 2 \times 4)}{4} \right) \text{ k}\Omega = 248 \text{ k}\Omega$$

Output Voltage Adjust Downwards, Decrease:

$$R_{adj} = 5.11 \times \left( \frac{100}{\Delta\%} - 2 \right) \text{ k}\Omega$$

Example: Decrease 2% =>  $V_{out} = 1.764 \text{ Vdc}$

$$5.11 \times \left( \frac{100}{2} - 2 \right) \text{ k}\Omega = 245 \text{ k}\Omega$$

**PKB 4000C Series DC-DC Converters**  
 Input 36-75 V, Output up to 60 A / 144 W

EN/LZT 146 377 R5A

November 2017

© Flex

**1.8 V/60 A Typical Characteristics**

**PKB 4118GC PI**

**Output Current Derating – Open frame**

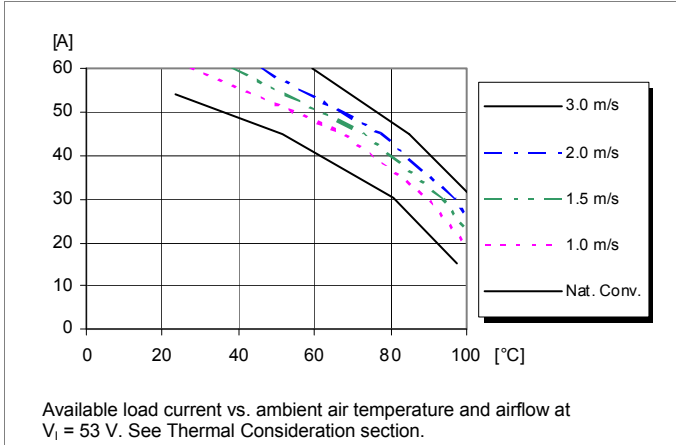

**Output Current Derating – Base plate**

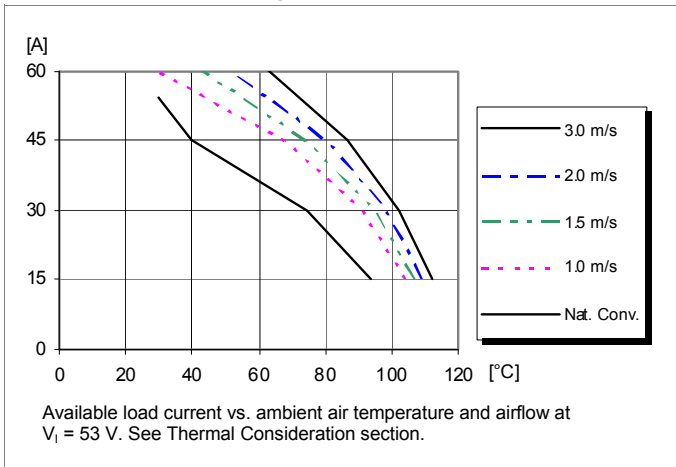

**Thermal Resistance – Base plate**

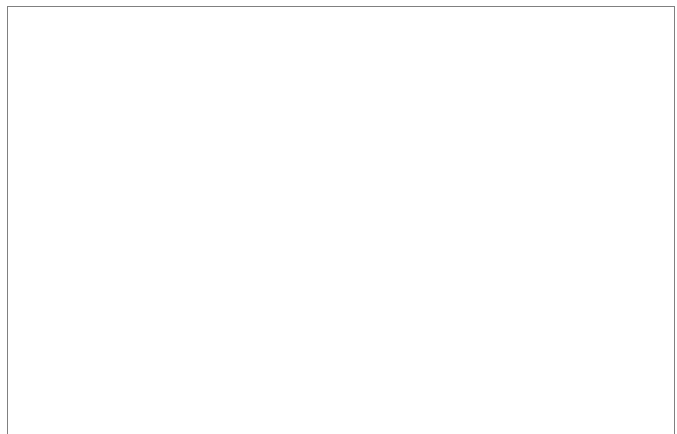
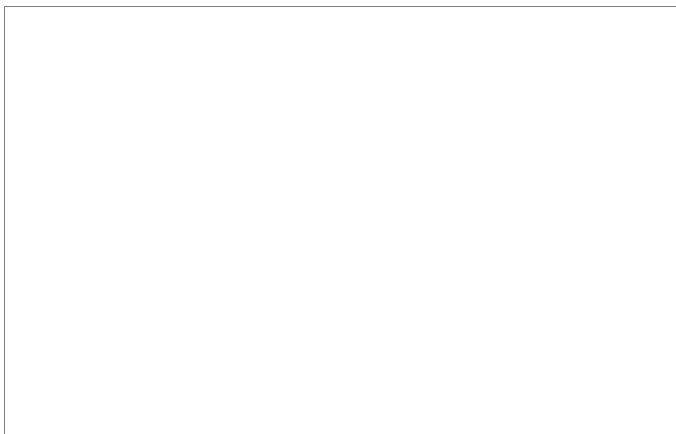
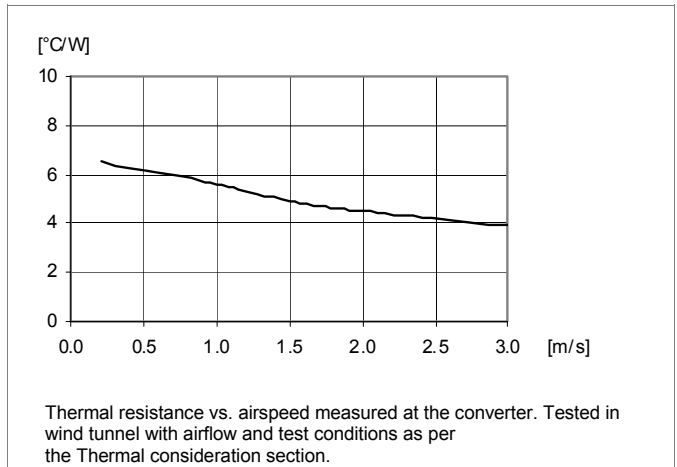

## Technical Specification

**PKB 4000C Series DC-DC Converters**  
 Input 36-75 V, Output up to 60 A / 144 W

EN/LZT 146 377 R5A

November 2017

© Flex

**3.3 V/40 A Electrical Specification**
**PKB 4110C PI**
 $T_{p1} = -40$  to  $+90^{\circ}\text{C}$ ,  $V_i = 36$  to  $75$  V, sense pins connected to output pins unless otherwise specified under Conditions.

 Typical values given at:  $T_{p1} = +25^{\circ}\text{C}$ ,  $V_i = 53$  V, max  $I_o$ , unless otherwise specified under Conditions.

Characteristics		Conditions	min	typ	max	Unit
$V_i$	Input voltage range		36		75	V
$V_{loff}$	Turn-off input voltage	Decreasing input voltage	29	31	33	V
$V_{lon}$	Turn-on input voltage	Increasing input voltage	30	33	36	V
$C_i$	Internal input capacitance			1		$\mu\text{F}$
$P_o$	Output power		0		132	W
$\eta$	Efficiency	50 % of max $I_o$		91		%
		max $I_o$		91		
		50 % of max $I_o$ , $V_i = 48$ V		91		
		max $I_o$ , $V_i = 48$ V		91		
$P_d$	Power Dissipation	max $I_o$		13.1	16.7	W
$P_{ii}$	Input idling power	$I_o = 0$ A, $V_i = 53$ V		3.8		W
$P_{RC}$	Input standby power	$V_i = 53$ V (turned off with RC)		0.06		W
$f_s$	Switching frequency	0-100 % of max $I_o$		250		kHz

$V_{oi}$	Output voltage initial setting and accuracy	$T_{p1} = +25^{\circ}\text{C}$ , $V_i = 53$ V, $I_o = 40$ A	3.23	3.29	3.35	V
$V_o$	Output adjust range	See operating information	2.64		3.63	V
	Output voltage tolerance band	10-100% of max $I_o$	3.22		3.36	V
	Idling voltage	$I_o = 0$ A	3.22		3.36	V
	Line regulation	max $I_o$		0	5	mV
	Load regulation	$V_i = 53$ V, 1-100% of max $I_o$		0	10	mV
$V_{tr}$	Load transient voltage deviation	$V_i = 53$ V, Load step 25-75-25 % of max $I_o$ , $di/dt = 1$ A/ $\mu\text{s}$ , see Note 2		$\pm 350$		mV
$t_{tr}$	Load transient recovery time			50		$\mu\text{s}$
$t_r$	Ramp-up time (from 10-90 % of $V_{oi}$ )	10-100% of max $I_o$		6	10	ms
$t_s$	Start-up time (from $V_i$ connection to 90% of $V_{oi}$ )	$T_{p1} = 25^{\circ}\text{C}$ , $V_i = 53$ V		12	15	ms
$t_f$	$V_{in}$ shutdown fall time (from $V_i$ off to 10% of $V_o$ )	max $I_o$		0.1		ms
		$I_o = 0$ A		8		s
$t_{RC}$	RC start-up time	max $I_o$		9		ms
	RC shutdown fall time (from RC off to 10% of $V_o$ )	max $I_o$		0.1		ms
		$I_o = 0$ A		8		s
$I_o$	Output current		0		40	A
$I_{lim}$	Current limit threshold	$V_o = 3.2$ V, $T_{p1} < \text{max } T_{p1}$	41	46	53	A
$I_{sc}$	Short circuit current	$T_{p1} = 25^{\circ}\text{C}$ , $V_o < 0.5$ V, see Note 3		15		A
$V_{Oac}$	Output ripple & noise	See ripple & noise section, max $I_o$ , $V_{oi}$		65	130	mVp-p
OVP	Over voltage protection	$T_{p1} = +25^{\circ}\text{C}$ , $V_i = 53$ V, 10-100% of max $I_o$		4.3		V

Note 2: Output filter according to Ripple &amp; Noise section.

Note 3: RMS current in hiccup mode.

Technical Specification

**PKB 4000C Series DC-DC Converters**  
 Input 36-75 V, Output up to 60 A / 144 W

EN/LZT 146 377 R5A

November 2017

© Flex

**3.3 V/40 A Typical Characteristics**

**PKB 4110C PI**

**Efficiency**

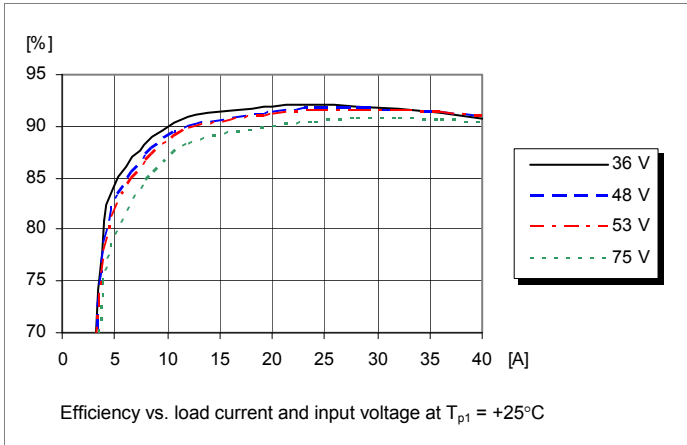

**Power Dissipation**

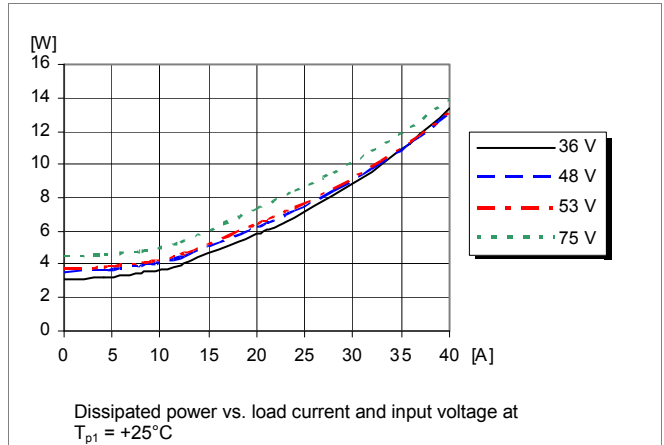

**Output Characteristics**

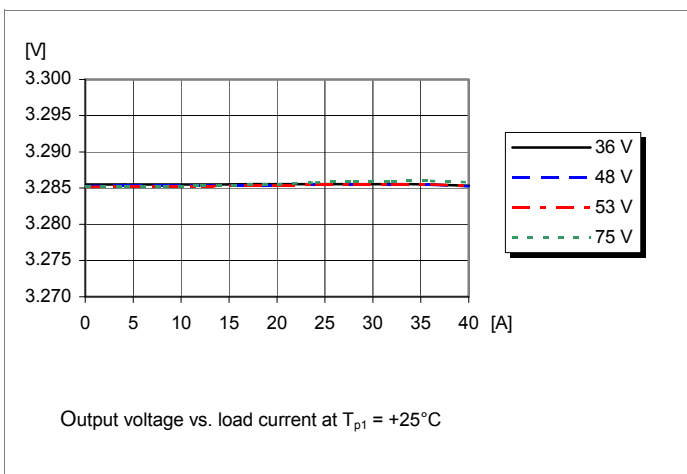

**Current Limit Characteristics**

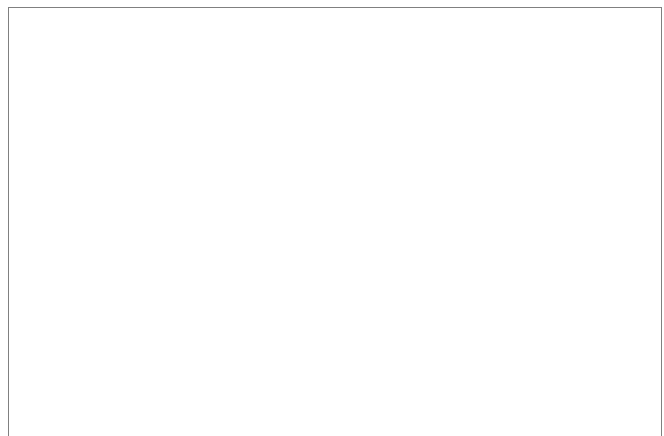
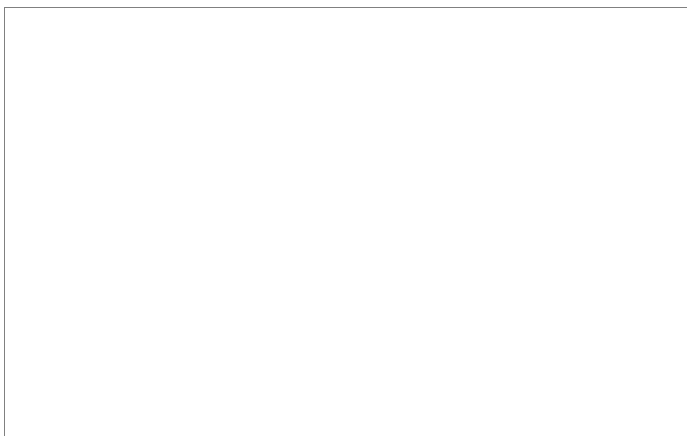
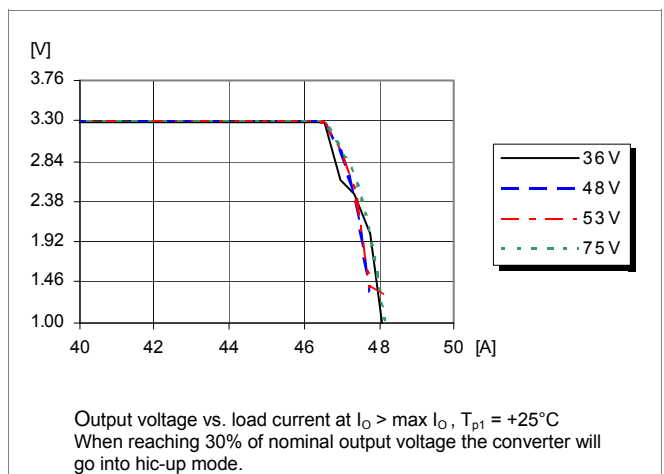

Technical Specification

**PKB 4000C Series DC-DC Converters**  
 Input 36-75 V, Output up to 60 A / 144 W

EN/LZT 146 377 R5A

November 2017

© Flex

**3.3 V/40 A Typical Characteristics**

**PKB 4110C PI**

**Start-up**

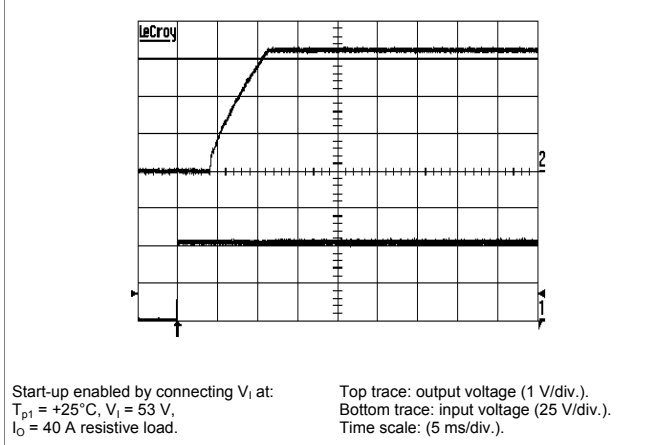

**Shut-down**

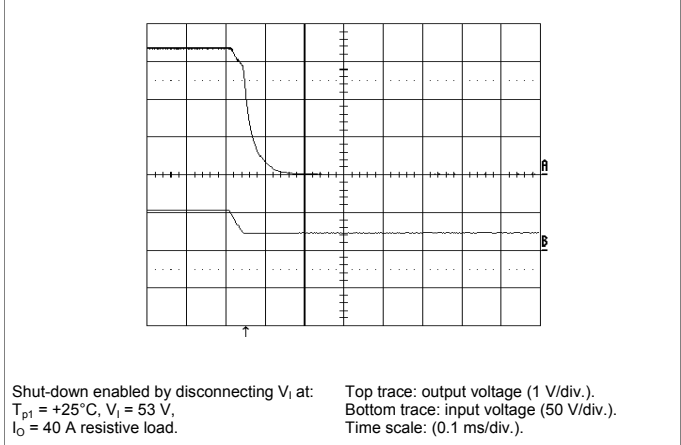

**Output Ripple & Noise**

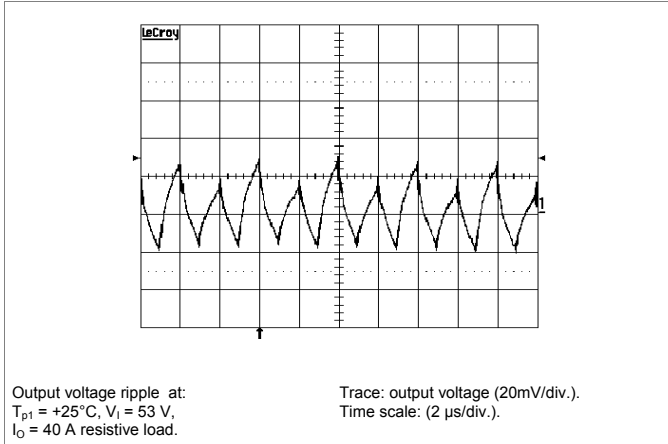

**Output Load Transient Response**

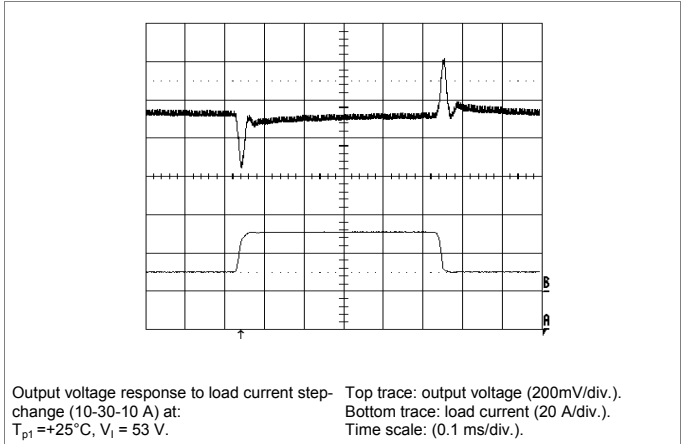

**Output Voltage Adjust (see operating information)**

**Passive adjust**

The resistor value for an adjusted output voltage is calculated by using the following equations:

Output Voltage Adjust Upwards, Increase:

$$R_{adj} = 5.11 \times \left( \frac{3.3(100 + \Delta\%)}{1.225 \times \Delta\%} - \frac{(100 + 2 \times \Delta\%)}{\Delta\%} \right) \text{ k}\Omega$$

Example: Increase 4% =>  $V_{out} = 3.43\text{ Vdc}$

$$5.11 \times \left( \frac{3.3(100 + 4)}{1.225 \times 4} - \frac{(100 + 2 \times 4)}{4} \right) \text{ k}\Omega = 220 \text{ k}\Omega$$

Output Voltage Adjust Downwards, Decrease:

$$R_{adj} = 5.11 \times \left( \frac{100}{\Delta\%} - 2 \right) \text{ k}\Omega$$

Example: Decrease 2% =>  $V_{out} = 3.23\text{ Vdc}$

$$5.11 \times \left( \frac{100}{2} - 2 \right) \text{ k}\Omega = 245 \text{ k}\Omega$$

**PKB 4000C Series DC-DC Converters**  
 Input 36-75 V, Output up to 60 A / 144 W

EN/LZT 146 377 R5A

November 2017

© Flex

### 3.3 V/40 A Typical Characteristics

**PKB 4110C PI**

#### Output Current Derating – Open frame

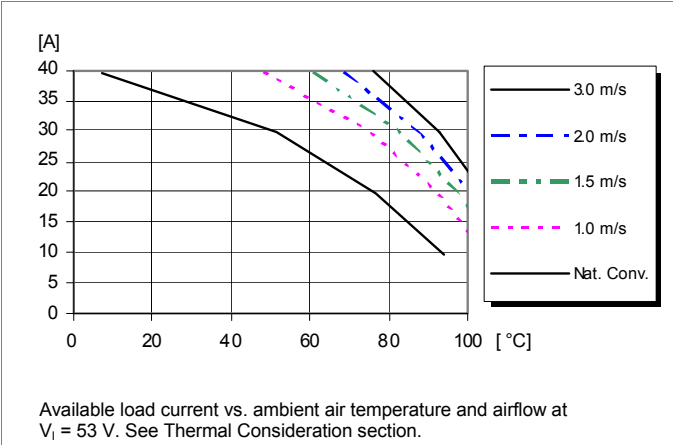

#### Output Current Derating – Base plate

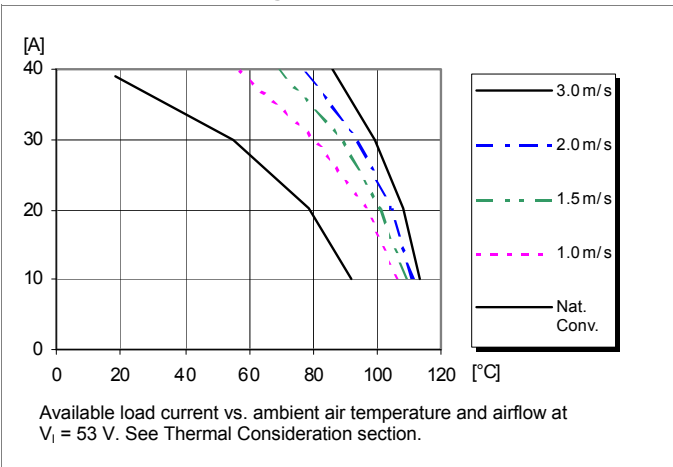

#### Thermal Resistance – Base plate

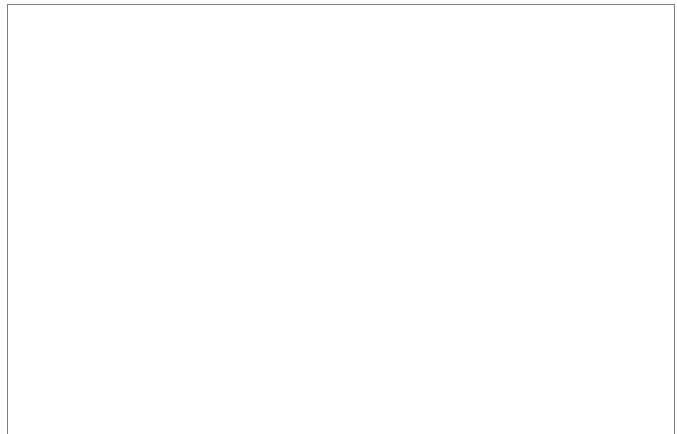
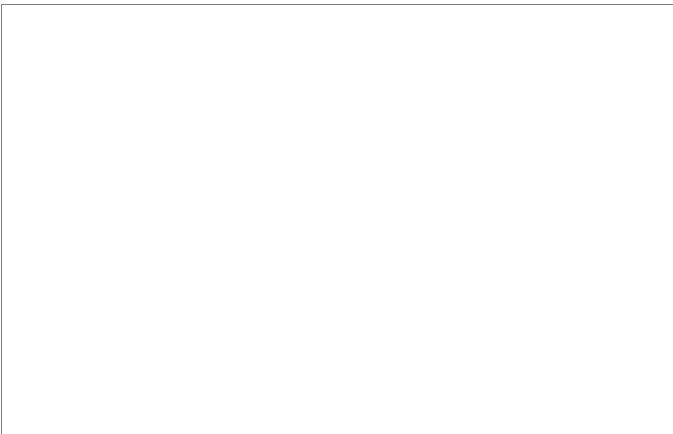
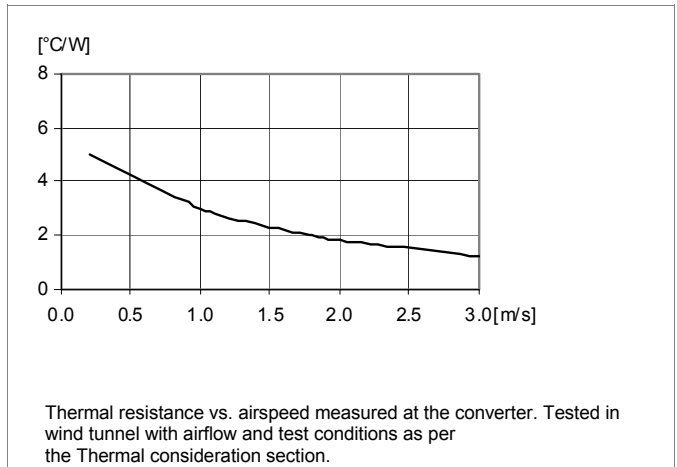

## Technical Specification

**PKB 4000C Series DC-DC Converters**  
Input 36-75 V, Output up to 60 A / 144 W

EN/LZT 146 377 R5A

November 2017

© Flex

**5.0 V/28 A Electrical Specification****PKB 4111C PI**

$T_{p1} = -40$  to  $+90^{\circ}\text{C}$ ,  $V_i = 36$  to  $75$  V, sense pins connected to output pins unless otherwise specified under Conditions.  
Typical values given at:  $T_{p1} = +25^{\circ}\text{C}$ ,  $V_i = 53$  V, max  $I_o$ , unless otherwise specified under Conditions.

Characteristics		Conditions	min	typ	max	Unit
$V_i$	Input voltage range		36		75	V
$V_{loff}$	Turn-off input voltage	Decreasing input voltage	29	31	33	V
$V_{lon}$	Turn-on input voltage	Increasing input voltage	30	33	36	V
$C_i$	Internal input capacitance			1		$\mu\text{F}$
$P_o$	Output power		0		140	W
$\eta$	Efficiency	50 % of max $I_o$		92		%
		max $I_o$		92		
		50 % of max $I_o$ , $V_i = 48$ V		92		
		max $I_o$ , $V_i = 48$ V		92		
$P_d$	Power Dissipation	max $I_o$		12.5	17	W
$P_{ii}$	Input idling power	$I_o = 0$ A, $V_i = 53$ V		4		W
$P_{RC}$	Input standby power	$V_i = 53$ V (turned off with RC)		60		mW
$f_s$	Switching frequency	0-100 % of max $I_o$		250		kHz

$V_{oi}$	Output voltage initial setting and accuracy	$T_{p1} = +25^{\circ}\text{C}$ , $V_i = 53$ V, $I_o = 28$ A	4.9	5	5.1	V
$V_o$	Output adjust range	See operating information	4		5.5	V
	Output voltage tolerance band	10-100% of max $I_o$	4.87		5.13	V
	Idling voltage	$I_o = 0$ A	4.87		5.13	V
	Line regulation	max $I_o$		0	8	mV
	Load regulation	$V_i = 53$ V, 1-100% of max $I_o$		0	10	mV
$V_{tr}$	Load transient voltage deviation	$V_i = 53$ V, Load step 25-75-25 % of max $I_o$ , $di/dt = 1$ A/ $\mu\text{s}$ , see Note 1		$\pm 350$		mV
$t_{tr}$	Load transient recovery time			50		$\mu\text{s}$
$t_r$	Ramp-up time (from 10-90 % of $V_{oi}$ )	10-100% of max $I_o$		6	10	ms
$t_s$	Start-up time (from $V_i$ connection to 90% of $V_{oi}$ )	$T_{p1} = 25^{\circ}\text{C}$ , $V_i = 53$ V		12	15	ms
$t_f$	$V_{in}$ shutdown fall time (from $V_i$ off to 10% of $V_o$ )	max $I_o$		0.2		ms
		$I_o = 0$ A		8		s
$t_{RC}$	RC start-up time	max $I_o$		9		ms
	RC shutdown fall time (from RC off to 10% of $V_o$ )	max $I_o$		0.2		ms
		$I_o = 0$ A		8		s
$I_o$	Output current		0		28	A
$I_{lim}$	Current limit threshold	$V_o = 3.2$ V, $T_{p1} < \text{max } T_{p1}$	30	35	42	A
$I_{sc}$	Short circuit current	$T_{p1} = 25^{\circ}\text{C}$ , $V_o < 0.5$ V, see Note 2		10		A
$V_{Oac}$	Output ripple & noise	See ripple & noise section, max $I_o$ , $V_{oi}$		60	150	mVp-p
OVP	Over voltage protection	$T_{p1} = +25^{\circ}\text{C}$ , $V_i = 53$ V, 10-100% of max $I_o$		6.5		V

Note 1: Output filter according to Ripple & Noise section.

Note 2: RMS current in hiccup mode.

Technical Specification

**PKB 4000C Series DC-DC Converters**  
 Input 36-75 V, Output up to 60 A / 144 W

EN/LZT 146 377 R5A

November 2017

© Flex

**5.0 V/28 A Typical Characteristics**

**PKB 4111C PI**

**Efficiency**

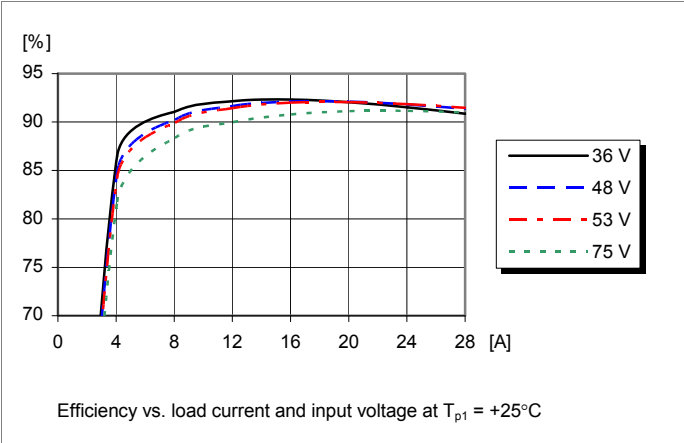

**Power Dissipation**

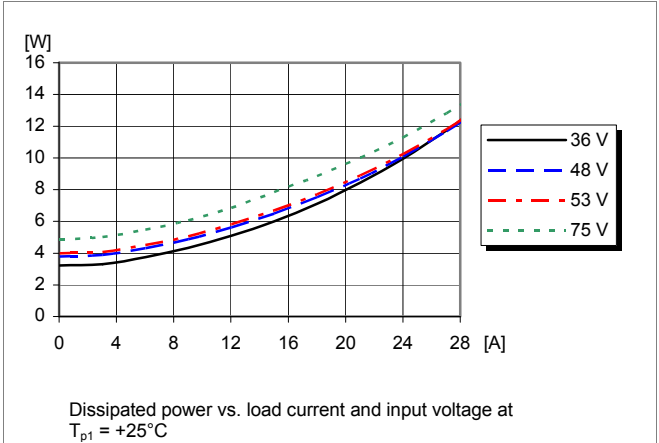

**Output Characteristics**

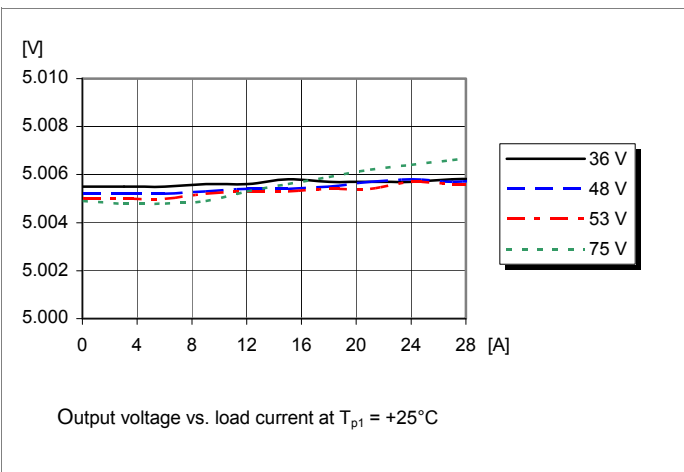

**Current Limit Characteristics**

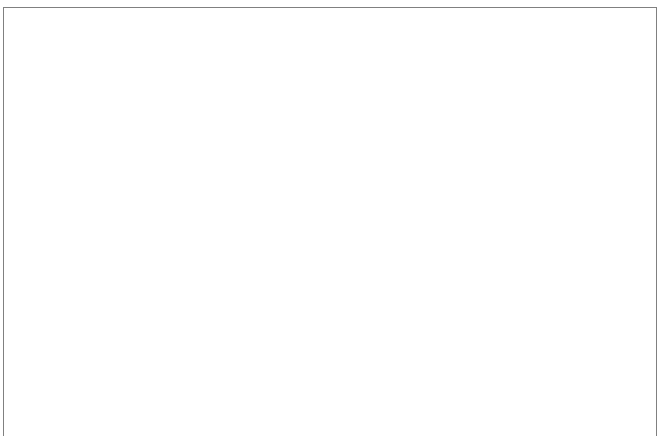
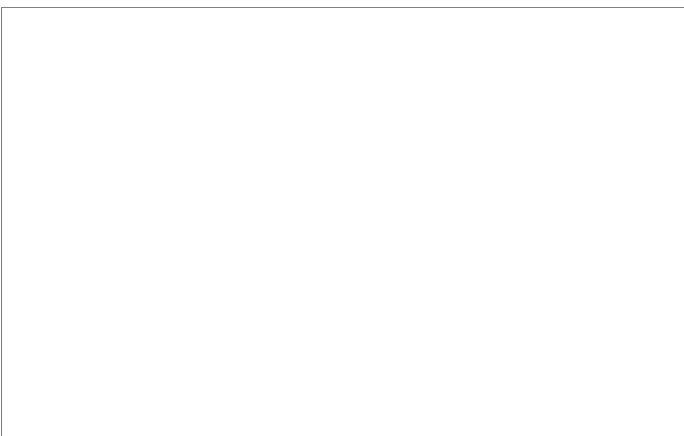
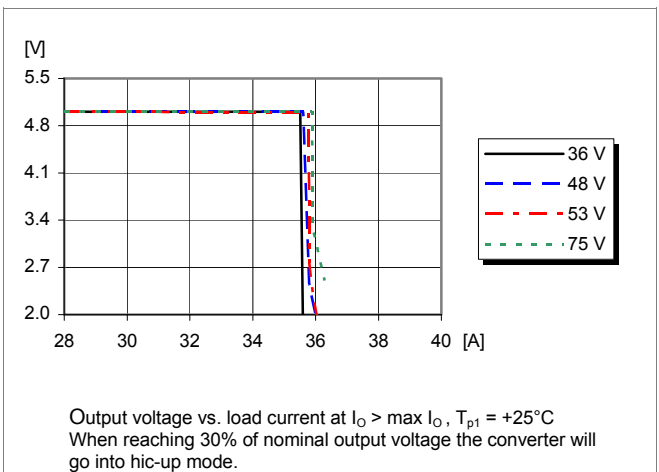

Technical Specification

**PKB 4000C Series DC-DC Converters**  
 Input 36-75 V, Output up to 60 A / 144 W

EN/LZT 146 377 R5A

November 2017

© Flex

**5.0 V/28 A Typical Characteristics**

**PKB 4111C PI**

**Start-up**

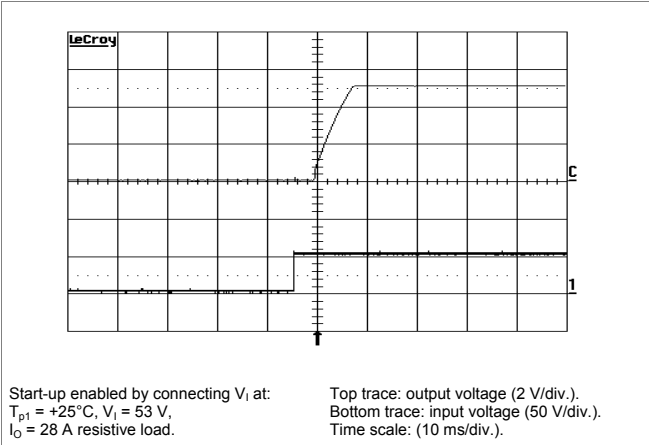

**Shut-down**

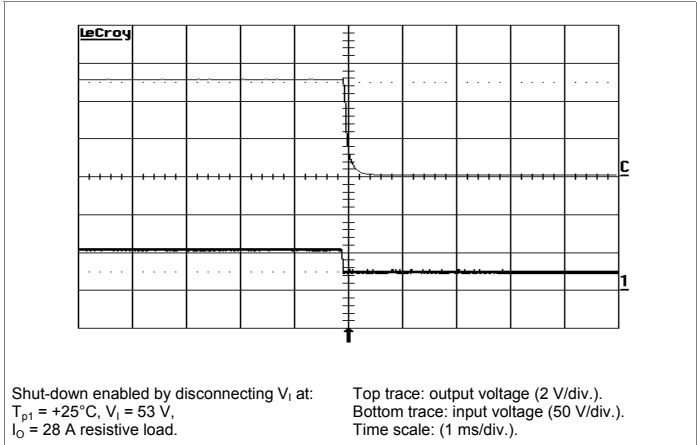

**Output Ripple & Noise**

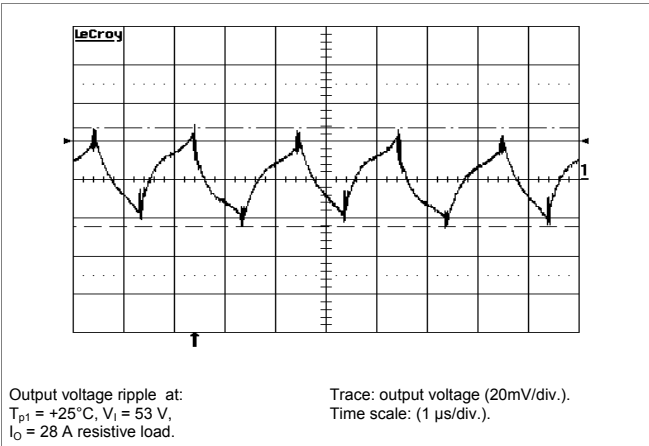

**Output Load Transient Response**

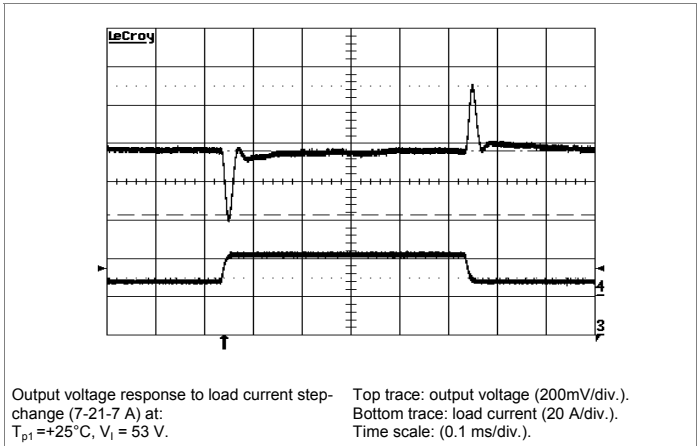

**Output Voltage Adjust (see operating information)**

**Passive adjust**

The resistor value for an adjusted output voltage is calculated by using the following equations:

Output Voltage Adjust Upwards, Increase:

$$Radj = 5.11 \times \left( \frac{5 \times (100 + \Delta\%) }{1.225 \times \Delta\%} - \frac{(100 + 2 \times \Delta\%) }{\Delta\%} \right) \text{ k}\Omega$$

Example: Increase 4% =>  $V_{out} = 5.2\text{ Vdc}$

$$5.11 \times \left( \frac{5 \times (100 + 4) }{1.225 \times 4} - \frac{(100 + 2 \times 4) }{4} \right) \text{ k}\Omega = 404 \text{ k}\Omega$$

Output Voltage Adjust Downwards, Decrease:

$$Radj = 5.11 \times \left( \frac{100}{\Delta\%} - 2 \right) \text{ k}\Omega$$

Example: Decrease 2% =>  $V_{out} = 4.9\text{ Vdc}$

$$5.11 \times \left( \frac{100}{2} - 2 \right) \text{ k}\Omega = 245 \text{ k}\Omega$$

Technical Specification

**PKB 4000C Series DC-DC Converters**  
 Input 36-75 V, Output up to 60 A / 144 W

EN/LZT 146 377 R5A

November 2017

© Flex

**5.0 V/28 A Typical Characteristics**

**PKB 4111C PI**

**Output Current Derating – Open frame**

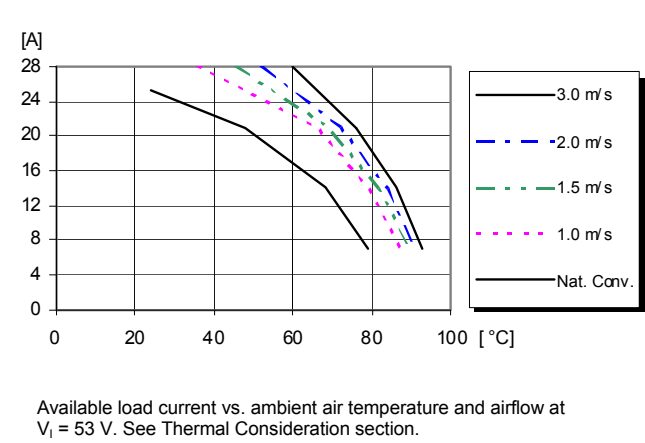

**Output Current Derating – Base plate**

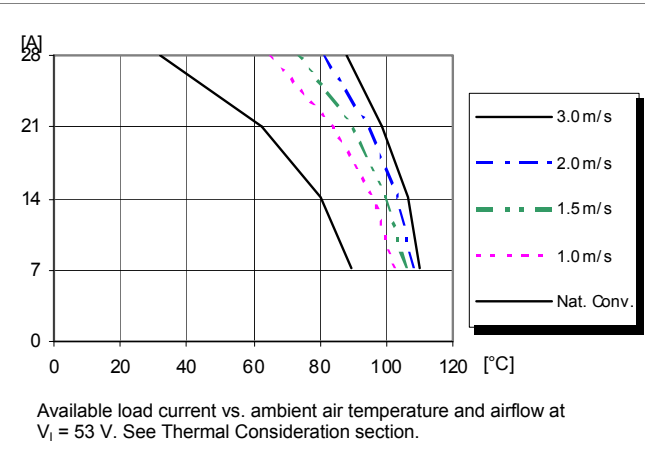

**Thermal Resistance – Base plate**

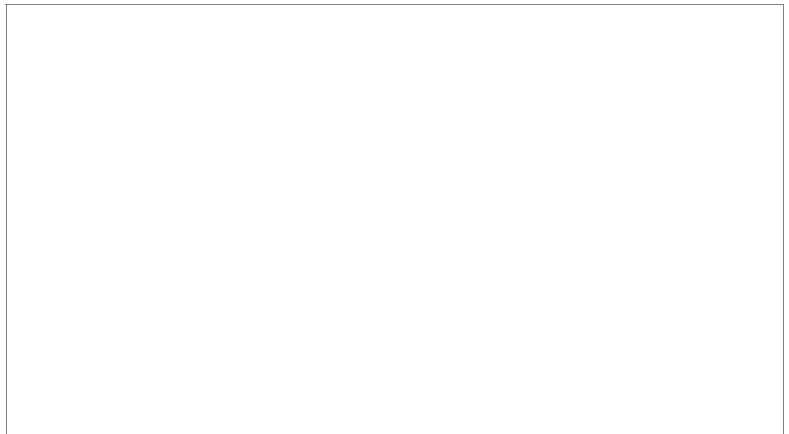
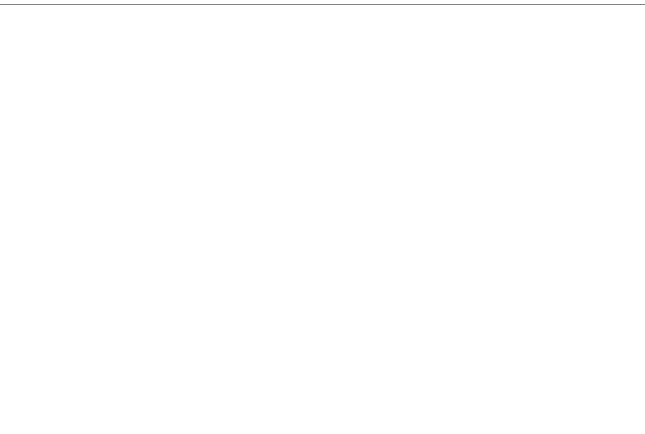
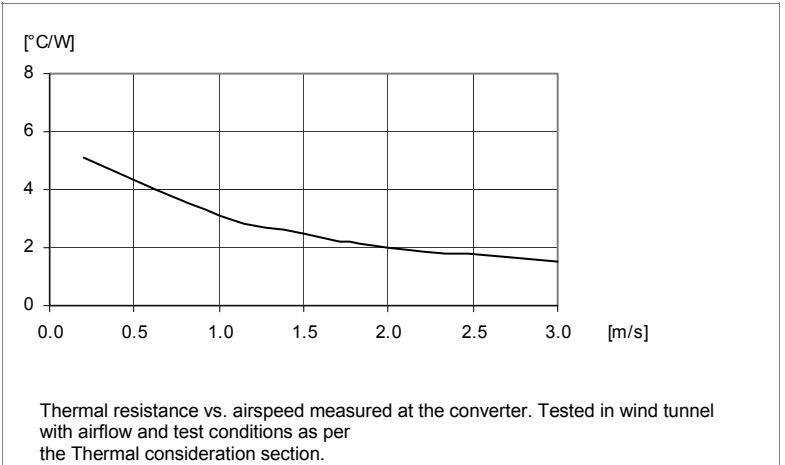

## Technical Specification

**PKB 4000C Series DC-DC Converters**  
Input 36-75 V, Output up to 60 A / 144 W

EN/LZT 146 377 R5A

November 2017

© Flex

**12 V/12 A Electrical Specification****PKB 4113C PI**

$T_{p1} = -40$  to  $+90^{\circ}\text{C}$ ,  $V_i = 36$  to  $75$  V, sense pins connected to output pins unless otherwise specified under Conditions.

Typical values given at:  $T_{p1} = +25^{\circ}\text{C}$ ,  $V_i = 53$  V, max  $I_o$ , unless otherwise specified under Conditions.

Characteristics		Conditions	min	typ	max	Unit
$V_i$	Input voltage range		36		75	V
$V_{loff}$	Turn-off input voltage	Decreasing input voltage	29	31	33	V
$V_{lon}$	Turn-on input voltage	Increasing input voltage	30	33	36	V
$C_i$	Internal input capacitance			1		$\mu\text{F}$
$P_o$	Output power		0		144	W
$\eta$	Efficiency	50 % of max $I_o$		92.5		%
		max $I_o$		93		
		50 % of max $I_o$ , $V_i = 48$ V		93		
		max $I_o$ , $V_i = 48$ V		93		
$P_d$	Power Dissipation	max $I_o$		11.4	14.8	W
$P_{ii}$	Input idling power	$I_o = 0$ A, $V_i = 53$ V		3.5		W
$P_{RC}$	Input standby power	$V_i = 53$ V (turned off with RC)		0.06		W
$f_s$	Switching frequency	0-100 % of max $I_o$		250		kHz

$V_{oi}$	Output voltage initial setting and accuracy	$T_{p1} = +25^{\circ}\text{C}$ , $V_i = 53$ V, $I_o = 12$ A	11.8	12	12.2	V
$V_o$	Output adjust range	See operating information, $T_{p1} = +25^{\circ}\text{C}$ , $V_i = 53$ V	9.6		13.2	V
	Output voltage tolerance band	10-100% of max $I_o$	11.7		12.3	V
	Idling voltage	$I_o = 0$ A	11.7		12.3	V
	Line regulation	max $I_o$		2	5	mV
	Load regulation	$V_i = 53$ V, 1-100% of max $I_o$		3	10	mV
$V_{tr}$	Load transient voltage deviation	$V_i = 53$ V, Load step 25-75-25 % of max $I_o$ , $di/dt = 1$ A/ $\mu\text{s}$ , see Note 2		$\pm 600$		mV
$t_{tr}$	Load transient recovery time			50		$\mu\text{s}$
$t_r$	Ramp-up time (from 10-90 % of $V_{oi}$ )	10-100% of max $I_o$		12	15	ms
$t_s$	Start-up time (from $V_i$ connection to 90% of $V_{oi}$ )	$T_{p1} = 25^{\circ}\text{C}$ , $V_i = 53$ V		18	32	ms
$t_f$	$V_{in}$ shutdown fall time (from $V_i$ off to 10% of $V_o$ )	max $I_o$		0.2		ms
		$I_o = 0$ A		5.7		s
$t_{RC}$	RC start-up time	max $I_o$		16		ms
	RC shutdown fall time (from RC off to 10% of $V_o$ )	max $I_o$		0.2		ms
		$I_o = 0$ A		5.7		s
$I_o$	Output current		0		12	A
$I_{lim}$	Current limit threshold	$V_o = 11.6$ V, $T_{p1} < \text{max } T_{p1}$	13	16.6	20	A
$I_{sc}$	Short circuit current	$T_{p1} = 25^{\circ}\text{C}$ , $V_o < 0.5$ V, see Note 3		7		A
$V_{Oac}$	Output ripple & noise	See ripple & noise section, max $I_o$ , $V_{oi}$		40	120	mVp-p
OVP	Over voltage protection	$T_{p1} = +25^{\circ}\text{C}$ , $V_i = 53$ V, 10-100% of max $I_o$		15.6		V

Note 2: Output filter according to Ripple & Noise section.

Note 3: RMS current in hiccup mode.

Technical Specification

**PKB 4000C Series DC-DC Converters**  
 Input 36-75 V, Output up to 60 A / 144 W

EN/LZT 146 377 R5A

November 2017

© Flex

**12 V/12 A Typical Characteristics**

**PKB 4113C PI**

**Efficiency**

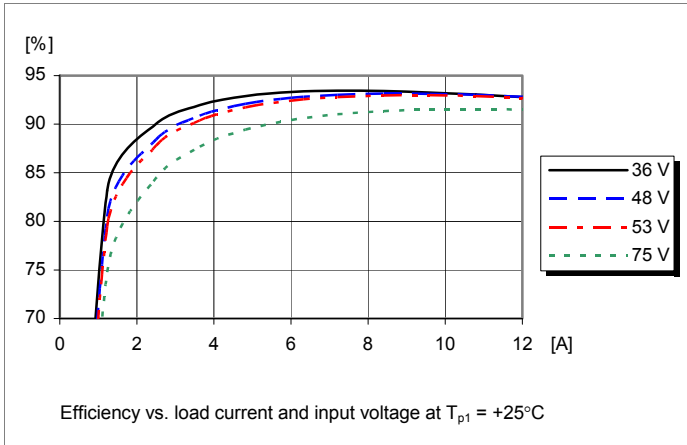

**Power Dissipation**

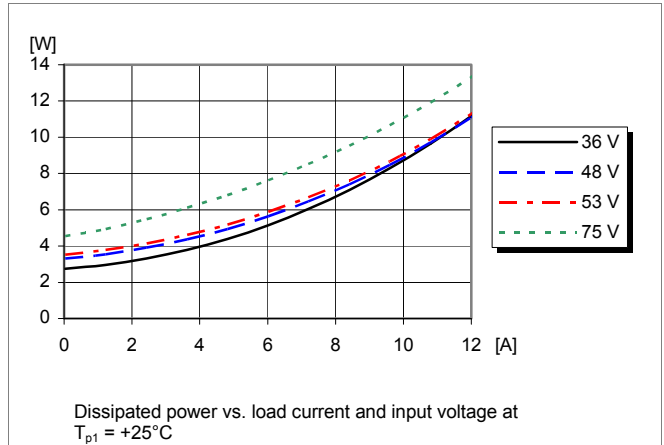

**Output Characteristics**

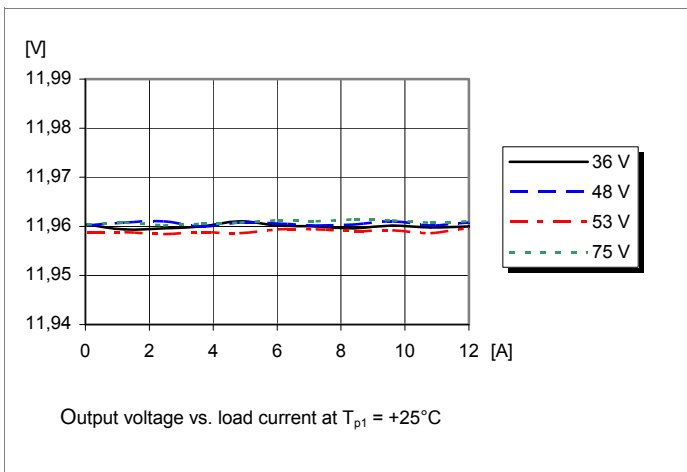

**Current Limit Characteristics**

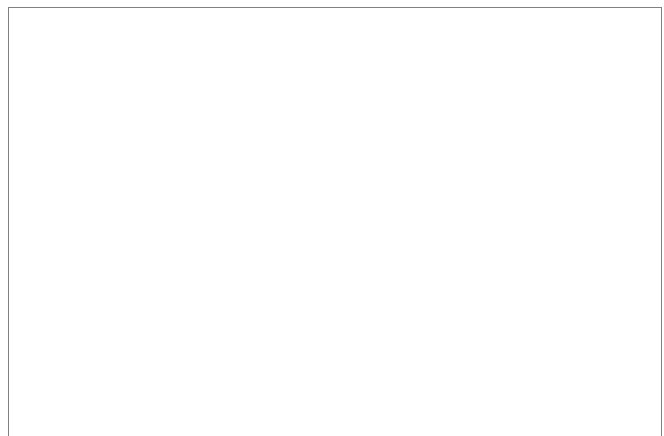
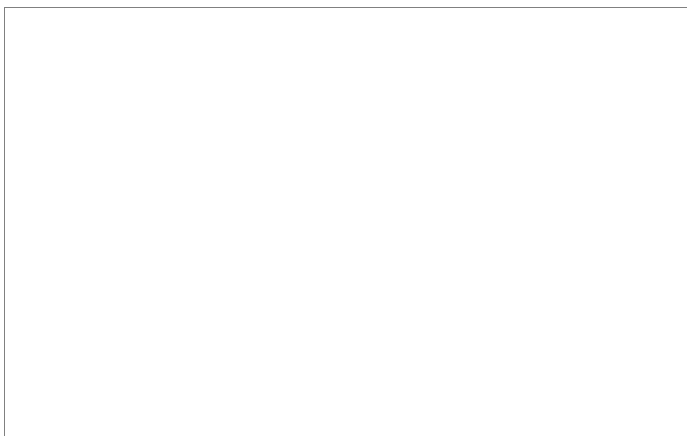
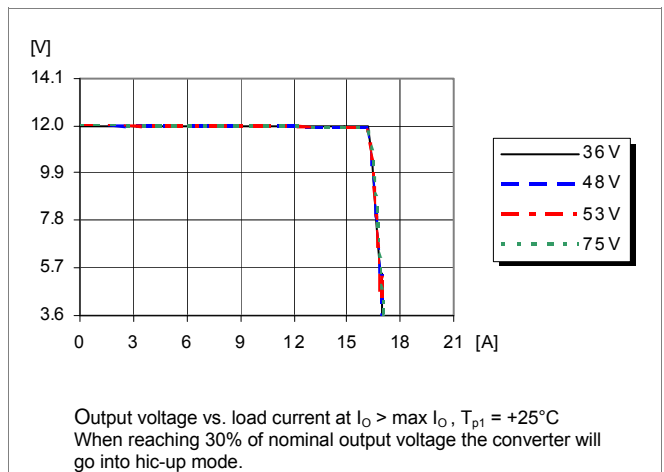

## Technical Specification

**PKB 4000C Series DC-DC Converters**  
 Input 36-75 V, Output up to 60 A / 144 W

EN/LZT 146 377 R5A

November 2017

© Flex

### 12 V/12 A Typical Characteristics

### PKB 4113C PI

#### Start-up

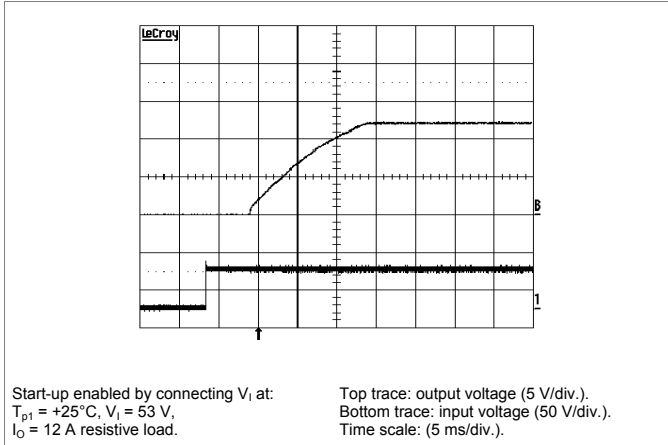

#### Shut-down

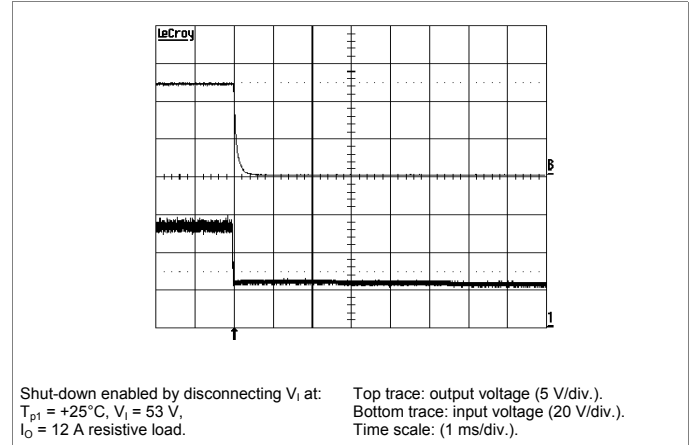

#### Output Ripple & Noise

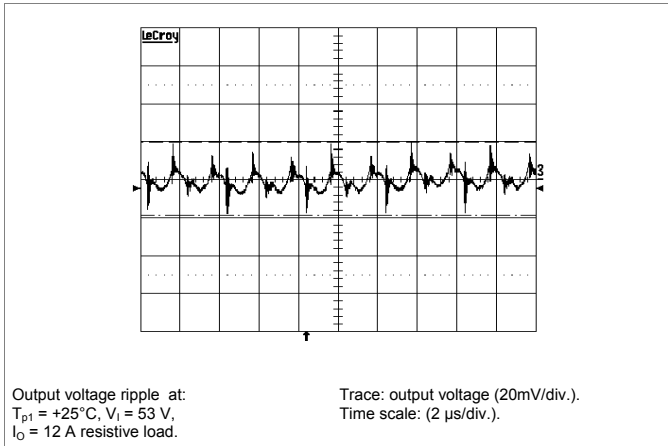

#### Output Load Transient Response

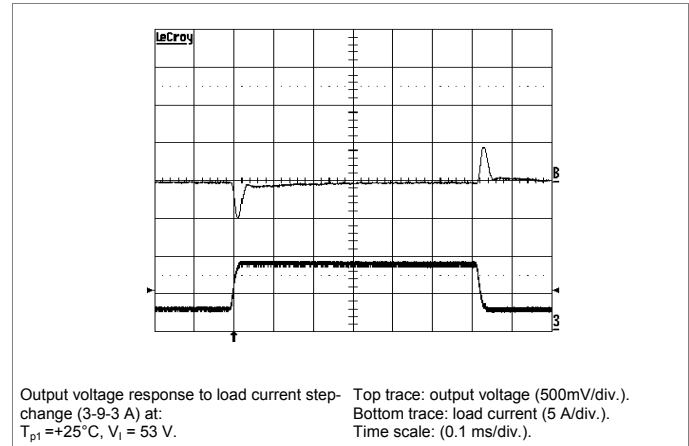

### Output Voltage Adjust (see operating information)

#### Passive adjust

The resistor value for an adjusted output voltage is calculated by using the following equations:

Output Voltage Adjust Upwards, Increase:

$$R_{adj} = 5.11 \times \left( \frac{12(100 + \Delta\%)}{1.225 \times \Delta\%} - \frac{(100 + 2 \times \Delta\%)}{\Delta\%} \right) \text{ k}\Omega$$

Example: Increase 4% =>  $V_{out} = 12.48\text{ Vdc}$

$$5.11 \times \left( \frac{12(100 + 4)}{1.225 \times 4} - \frac{(100 + 2 \times 4)}{4} \right) \text{ k}\Omega = 1164 \text{ k}\Omega$$

Output Voltage Adjust Downwards, Decrease:

$$R_{adj} = 5.11 \times \left( \frac{100}{\Delta\%} - 2 \right) \text{ k}\Omega$$

Example: Decrease 2% =>  $V_{out} = 11.76\text{ Vdc}$

$$5.11 \times \left( \frac{100}{2} - 2 \right) \text{ k}\Omega = 245 \text{ k}\Omega$$

**PKB 4000C Series DC-DC Converters**  
 Input 36-75 V, Output up to 60 A / 144 W

EN/LZT 146 377 R5A

November 2017

© Flex

**12 V/12 A Typical Characteristics**

**PKB 4113C PI**

**Output Current Derating – Open frame**

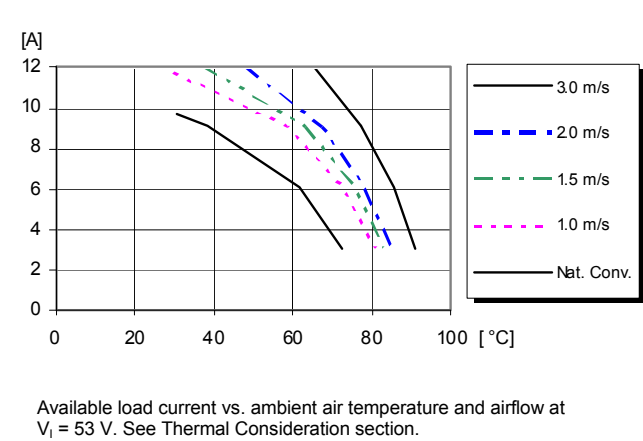

**Output Current Derating – Base plate**

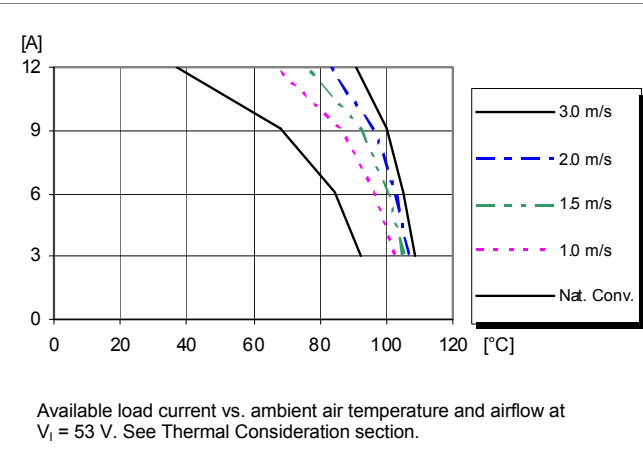

**Thermal Resistance – Base plate**

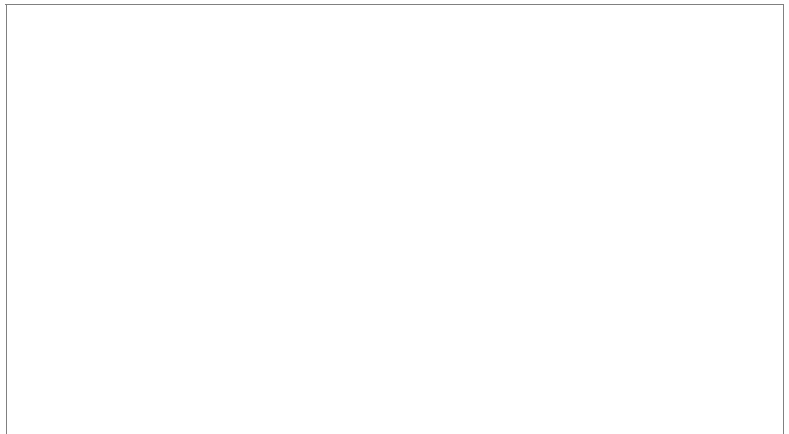
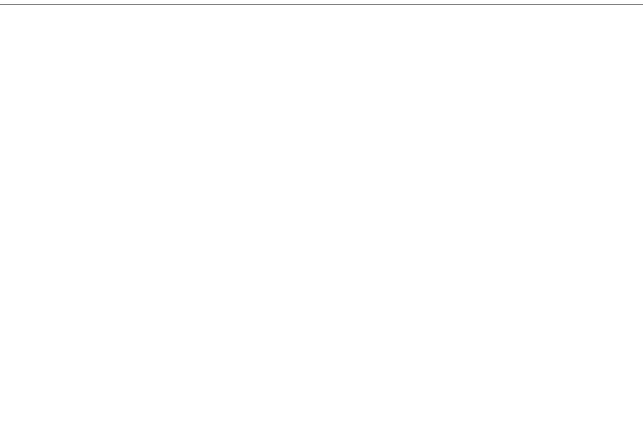
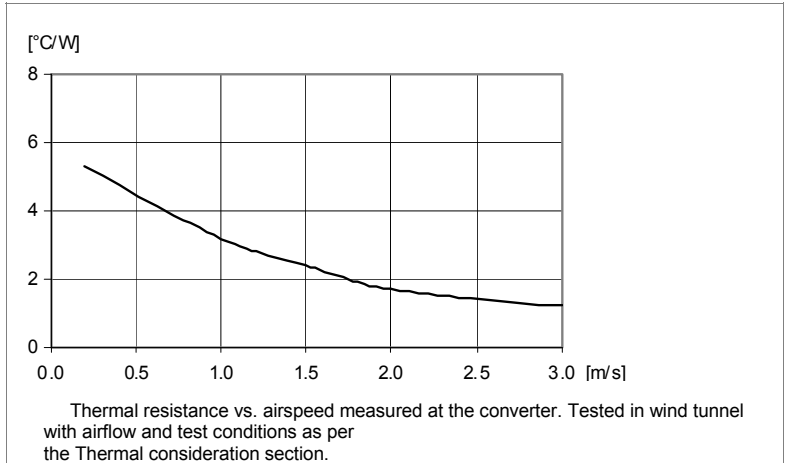

Technical Specification

**PKB 4000C Series DC-DC Converters**  
 Input 36-75 V, Output up to 60 A / 144 W

EN/LZT 146 377 R5A November 2017  
 © Flex

**EMC Specification**

Conducted EMI measured according to EN55022, CISPR 22 and FCC part 15J (see test set-up). See Design Note 009 for further information. The fundamental switching frequency is 250 kHz for PKB 4111C @  $V_1 = 53$  V, max  $I_o$ .

**Conducted EMI Input terminal value (typ)**

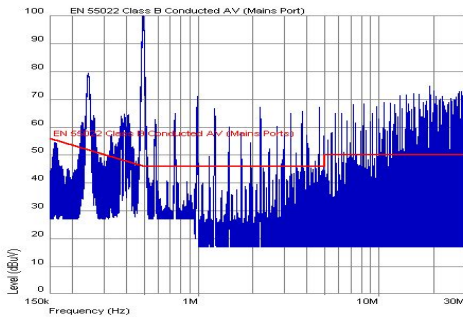

EMI without filter

**External filter (class B)**

Required external input filter in order to meet class B in EN 55022, CISPR 22 and FCC part 15J.

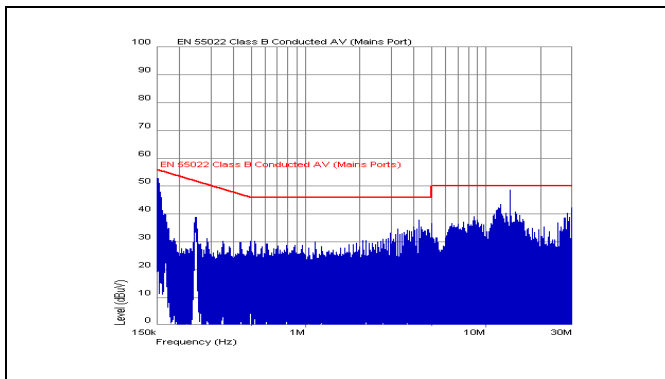
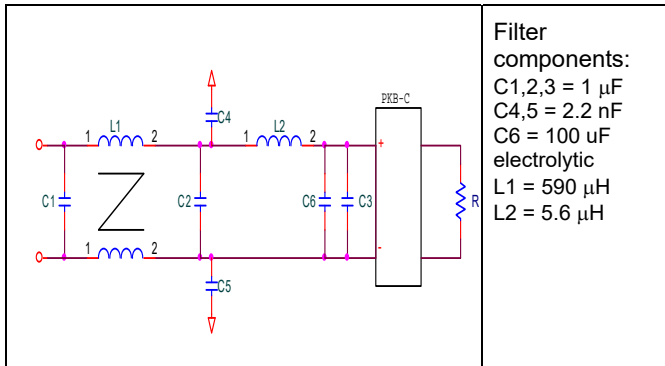

EMI with filter

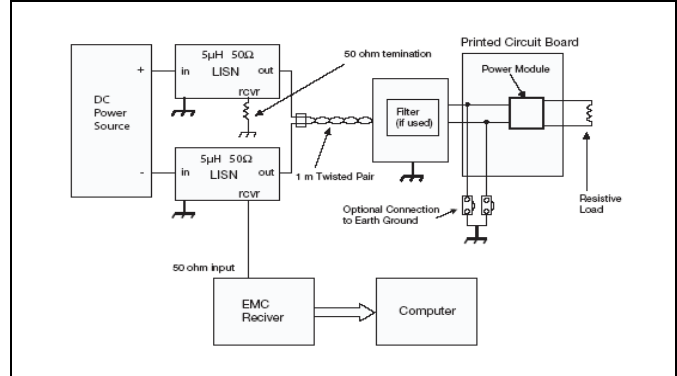

Test set-up

**Layout recommendation**

The radiated EMI performance of the DC/DC converter will depend on the PCB layout and ground layer design. It is also important to consider the stand-off of the DC/DC converter.

If a ground layer is used, it should be connected to the output of the DC/DC converter and the equipment ground or chassis.

A ground layer will increase the stray capacitance in the PCB and improve the high frequency EMC performance.

**Output ripple and noise**

Output ripple and noise measured according to figure below. See Design Note 022 for detailed information.

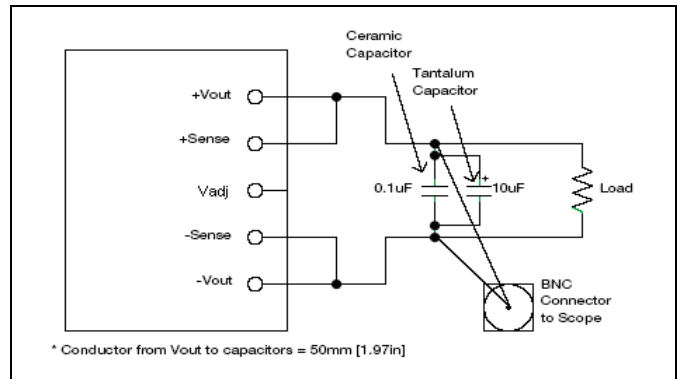

Output ripple and noise test setup

## Technical Specification

**PKB 4000C Series DC-DC Converters**  
Input 36-75 V, Output up to 60 A / 144 W

EN/LZT 146 377 R5A

November 2017

© Flex

## Operating information

### Input Voltage

The input voltage range 36 to 75Vdc meets the requirements of the European Telecom Standard ETS 300 132-2 for normal input voltage range in -48 and -60 Vdc systems, -40.5 to -57.0 V and -50.0 to -72 V respectively.

At input voltages exceeding 75 V, the power loss will be higher than at normal input voltage and  $T_{p1}$  must be limited to absolute max +90°C. The absolute maximum continuous input voltage is 80 Vdc.

### Turn-off Input Voltage

The DC/DC converters monitor the input voltage and will turn on and turn off at predetermined levels.

The minimum hysteresis between turn on and turn off input voltage is 1V.

### Remote Control (RC)

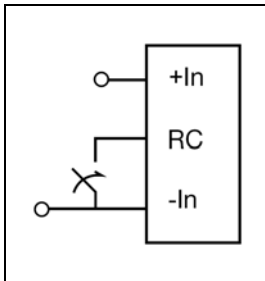

The products are fitted with a remote control function referenced to the primary negative input connection (- In), with negative and positive logic options available. The RC function allows the converter to be turned on/off by an external device like a semiconductor or mechanical switch. The RC pin has an internal pull up resistor to + In.

The maximum required sink current is 1 mA. When the RC pin is left open, the voltage generated on the RC pin is 4 – 6 V. The second option is “positive logic” remote control, which can be ordered by adding the suffix “P” to the end of the part number. The converter will turn on when the input voltage is applied with the RC pin open. Turn off is achieved by connecting the RC pin to the - In. To ensure safe turn off the voltage difference between RC pin and the - In pin shall be less than 1V. The converter will restart automatically when this connection is opened.

See Design Note 021 for detailed information.

### Input and Output Impedance

The impedance of both the input source and the load will interact with the impedance of the DC/DC converter. It is important that the input source has low characteristic impedance. The converters are designed for stable operation without external capacitors connected to the input or output. The performance in some applications can be enhanced by addition of external capacitance as described under External Decoupling Capacitors. If the input voltage source contains significant inductance, the addition of a 100  $\mu$ F capacitor across the input of the converter will ensure stable operation. The capacitor is not required when powering the DC/DC converter from an input source with an inductance below 10  $\mu$ H.

## External Decoupling Capacitors

When powering loads with significant dynamic current requirements, the voltage regulation at the point of load can be improved by addition of decoupling capacitors at the load. The most effective technique is to locate low ESR ceramic and electrolytic capacitors as close to the load as possible, using several parallel capacitors to lower the effective ESR. The ceramic capacitors will handle high-frequency dynamic load changes while the electrolytic capacitors are used to handle low frequency dynamic load changes. Ceramic capacitors will also reduce any high frequency noise at the load.

It is equally important to use low resistance and low inductance PCB layouts and cabling.

External decoupling capacitors will become part of the control loop of the DC/DC converter and may affect the stability margins. As a “rule of thumb”, 100  $\mu$ F/A of output current can be added without any additional analysis. The ESR of the capacitors is a very important parameter. Power Modules guarantee stable operation with a verified ESR value of >10 m $\Omega$  across the output connections.

For further information please contact your local Flex Power Modules representative.

## Output Voltage Adjust ( $V_{adj}$ )

The DC/DC converters have an Output Voltage Adjust pin ( $V_{adj}$ ). This pin can be used to adjust the output voltage above or below Output voltage initial setting.

When increasing the output voltage, the voltage at the output pins (including any remote sense compensation ) must be kept below the threshold of the over voltage protection, (OVP) to prevent the converter from shutting down. At increased output voltages the maximum power rating of the converter remains the same, and the max output current must be decreased correspondingly.

To increase the voltage the resistor should be connected between the  $V_{adj}$  pin and +Sense pin. The resistor value of the Output voltage adjust function is according to information given under the Output section for the respective product. To decrease the output voltage, the resistor should be connected between the  $V_{adj}$  pin and -Sense pin.

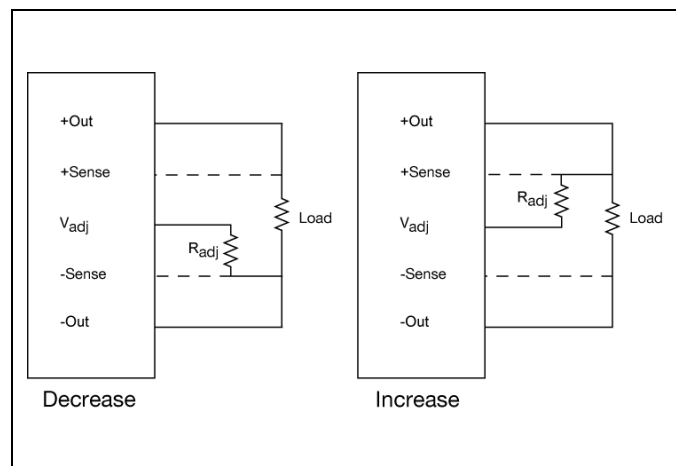

## Technical Specification

<b>PKB 4000C Series DC-DC Converters</b> Input 36-75 V, Output up to 60 A / 144 W	EN/LZT 146 377 R5A	November 2017
	© Flex	

**Operating information continued****Parallel Operation**

Two converters may be paralleled for redundancy if the total power is equal or less than  $P_O$  max. It is not recommended to parallel the converters without using external current sharing circuits.

See Design Note 006 for detailed information.

**Remote Sense**

The DC/DC converters have remote sense that can be used to compensate for voltage drops between the output and the point of load. The sense traces should be located close to the PCB ground layer to reduce noise susceptibility. The remote sense circuitry will compensate for up to 10% voltage drop between output pins and the point of load.

If the remote sense is not needed +Sense should be connected to +Out and -Sense should be connected to -Out.

**Over Temperature Protection (OTP)**

The converters are protected from thermal overload by an internal over temperature shutdown circuit.

When  $T_{p1}$  as defined in thermal consideration section exceeds 135°C the converter will shut down. The DC/DC converter will make continuous attempts to start up (non-latching mode) and resume normal operation automatically when the temperature has dropped >10°C below the temperature threshold.

The converters with latching option will shut down the module when  $T_{p1}$  exceeds 135°C and remain shut down until the module restarts by switching on/off the input voltage or Remote control.

**Over Voltage Protection (OVP)**

The converters have output over voltage protection that will shut down the converter in over voltage conditions. The converter will make continuous attempts to start up (non-latching mode) and resume normal operation automatically after removal of the over voltage condition.

The converters with latching option will shut down the module in over voltage condition and remain shut down until the converter restarts by switching on/off the input voltage or Remote control.

**Over Current Protection (OCP)**

The converters include current limiting circuitry for protection at continuous overload.

The output voltage will decrease towards 30% of nominal output voltage for output currents in excess of max output current ( $I_O$ ). When reaching 30% of nominal output voltage the converter will go into hic-up mode. The converter will resume normal operation after removal of the overload. The load distribution should be designed for the maximum output short circuit current specified.

The converters with latching option will shut down the module when reaching 30% of nominal output voltage and remain shut down until the converter restarts by switching on/off the input voltage or Remote control.

**Pre-bias Start-up**

The converter has a Pre-bias start up functionality. The converter will sink current in a controlled way during start up if a pre-bias source is present at the output terminals.

Technical Specification

**PKB 4000C Series DC-DC Converters**  
 Input 36-75 V, Output up to 60 A / 144 W

EN/LZT 146 377 R5A November 2017  
 © Flex

**Thermal Consideration**

**General**

The converters are designed to operate in different thermal environments and sufficient cooling must be provided to ensure reliable operation.

Cooling is achieved mainly by conduction, from the pins to the host board, and convection, which is dependant on the airflow across the converter. Increased airflow enhances the cooling of the converter.

The Output Current Derating graph found in the Output section for each model provides the available output current vs. ambient air temperature and air velocity at  $V_{in} = 53 V$ .

The DC/DC converter is tested on a 254 x 254 mm, 35  $\mu m$  (1 oz), 8-layer test board mounted vertically in a wind tunnel with a cross-section of 305 x 305 mm.

Proper cooling of the DC/DC converter can be verified by measuring the temperature at positions P1 or P2 ( see note 1). The temperature at these positions should not exceed the max values provided in the table below.

See Design Note 019 for further information.

Position	Device	Designation	max value
P <sub>1</sub>	Mosfet	T <sub>p1</sub>	125° C
P <sub>2</sub>	Ind. core	T <sub>p2</sub>	125° C

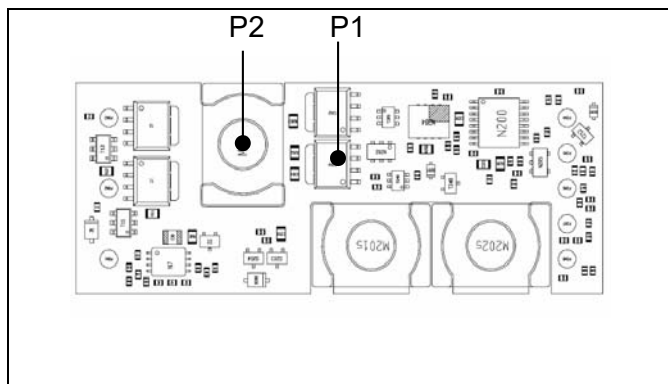

**Thermal Consideration continued**

The PKB4000C series DC/DC converters can be ordered with a heatsink (HS) option. The HS option is intended to be mounted on a cold wall or heatsink to transfer heat away from the converter and further improve the cooling of the converter.

**Definition of reference temperature (T<sub>p1</sub>)**

The reference temperature is used to monitor the temperature limits of the product. Temperatures above maximum T<sub>p1</sub> are not allowed and may cause degradation or permanent damage to the product. T<sub>p1</sub> is also used to define the temperature range for normal operating conditions.

T<sub>p1</sub> is defined by the design and used to guarantee safety margins, proper operation and high reliability of the module.

**Ambient Temperature Calculation**

By using the thermal resistance the maximum allowed ambient temperature can be calculated.

1. The power loss is calculated by using the formula  $((1/\eta) - 1) \times \text{output power} = \text{power losses (Pd)}$ .  
 $\eta$  = efficiency of converter. E.g. 89.5 % = 0.895

2. Find the thermal resistance (Rth) in the Thermal Resistance graph found in the Output section for each model. Calculate the temperature increase ( $\Delta T$ ).  
 $\Delta T = R_{th} \times P_d$

3. Max allowed ambient temperature is:  
 Max T<sub>p1</sub> -  $\Delta T$ .

E.g. PKB 4110C PI at 1m/s:

1.  $((\frac{1}{0.90}) - 1) \times 132 W = 14.7 W$

2.  $14.7 W \times 4.6^\circ C/W = 68^\circ C$

3.  $125^\circ C - 68^\circ C = \text{max ambient temperature is } 57^\circ C$

The actual temperature will be dependent on several factors such as the PCB size, number of layers and direction of airflow.

**Note 1**

P2 is the limiting component (T<sub>p1</sub>) used for thermal derating for PKB4113C. P1 is used for the rest of the modules in the PKB-C family.

## Technical Specification

**PKB 4000C Series** DC-DC Converters  
 Input 36-75 V, Output up to 60 A / 144 W

EN/LZT 146 377 R5A

November 2017

© Flex

## Connections

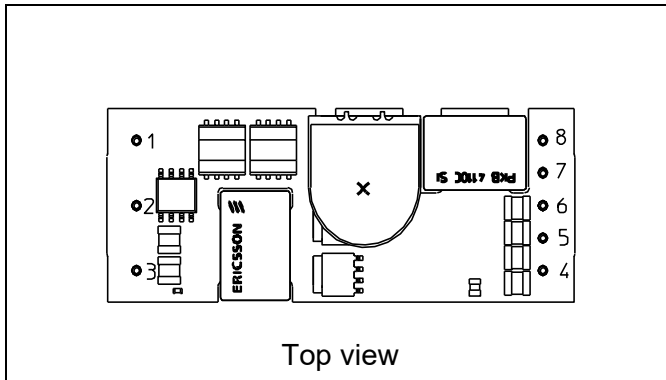

Pin	Designation	Function
1	+In	Positive input
2	RC	Remote control
3	-In	Negative input
4	-Out	Negative output
5	-Sen	Negative remote sense
6	Vadj	Output voltage adjust
7	+Sen	Positive remote sense
8	+Out	Positive output

Technical Specification

**PKB 4000C Series DC-DC Converters**  
 Input 36-75 V, Output up to 60 A / 144 W

EN/LZT 146 377 R5A November 2017  
 © Flex

**Mechanical Information- Surface Mount Version**

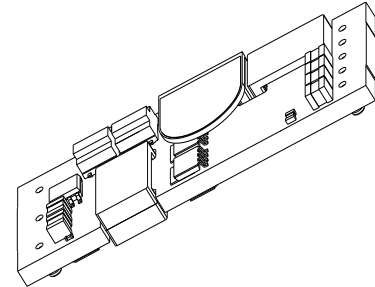
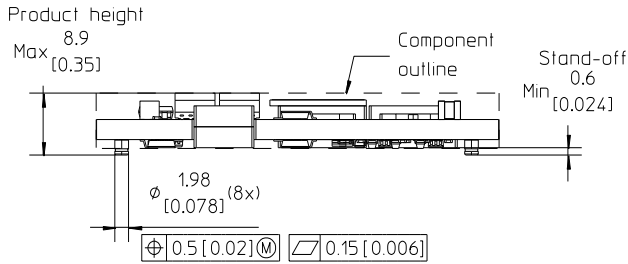

TOP VIEW  
 Pin positions according to recommended footprint.  
 58.4 [2.3]

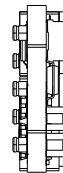
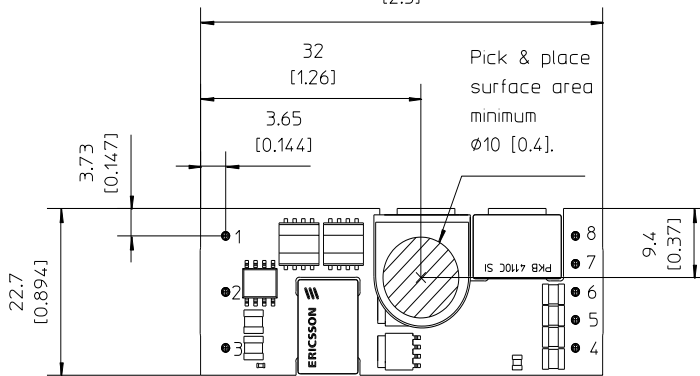

RECOMMENDED FOOTPRINT  
 TOP VIEW

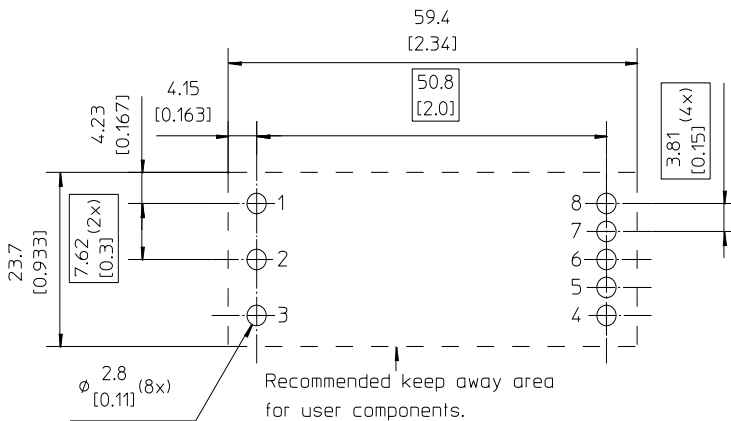

Layout considerations:  
 Use sufficient numbers of vias connected to output pin pads for good thermal and current conductivity.

Pins:  
 Material: Copper alloy  
 Plating: 0.1 μm Au over 2 μm Ni

Weight: 21 g typical

All dimensions in mm [inch].  
 Tolerances unless specified:  
 X.x mm ±0.5 mm [0.02]



X.xx mm ±0.25 mm [0.01]  
 (not applied on footprint or typical values)

Technical Specification

**PKB 4000C Series DC-DC Converters**  
 Input 36-75 V, Output up to 60 A / 144 W

EN/LZT 146 377 R5A November 2017  
 © Flex

**Mechanical Information - Hole Mount Version**

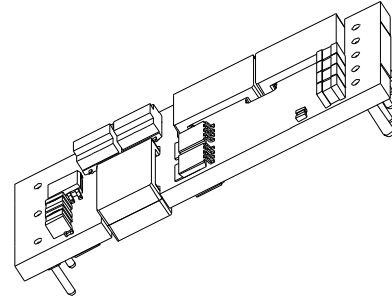
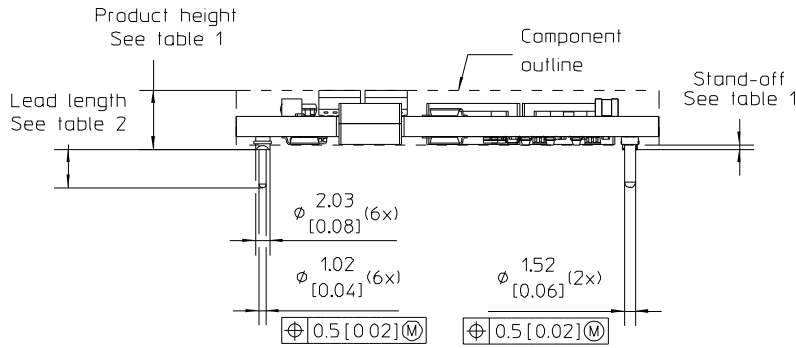

TOP VIEW  
 Pin positions according to recommended footprint.  
 58.4 [2.3]

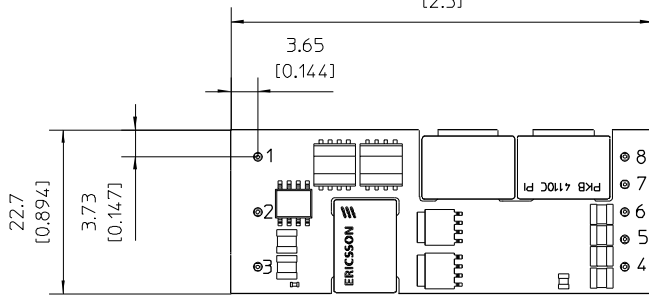

RECOMMENDED FOOTPRINT  
 TOP VIEW  
 59.9 [2.358]

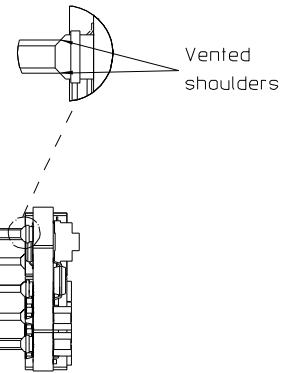
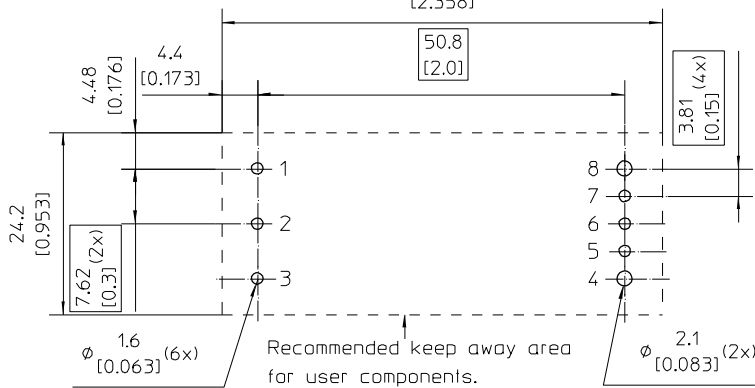

Table 1

Height option	Height max.	Stand-off min.
Standard	8.6 [0.34]	0.25 [0.01]
M	9.6 [0.38]	1.25 [0.05]

Table 2

Pin option	Lead Length
Standard	5.33 [0.21]
LA	3.69 [0.145]
LB	4.57 [0.18]

Pins:  
 Material:  
 Pins 1-3, 5-7: Brass  
 Pins 4,8: Copper alloy  
 Plating: 0.1 μm Au over 2 μm Ni

Weight: 21 g typical

All dimensions in mm [inch].  
 Tolerances unless specified:  
 X.x mm ±0.5 mm [0.02]  
 X.xx mm ±0.25 mm [0.01]

(not applied on footprint or typical values)

Technical Specification

**PKB 4000C Series DC-DC Converters**  
 Input 36-75 V, Output up to 60 A / 144 W

EN/LZT 146 377 R5A November 2017  
 © Flex

**Mechanical Information - Hole Mount - Base Plate Version**

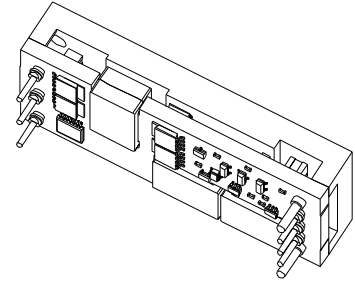
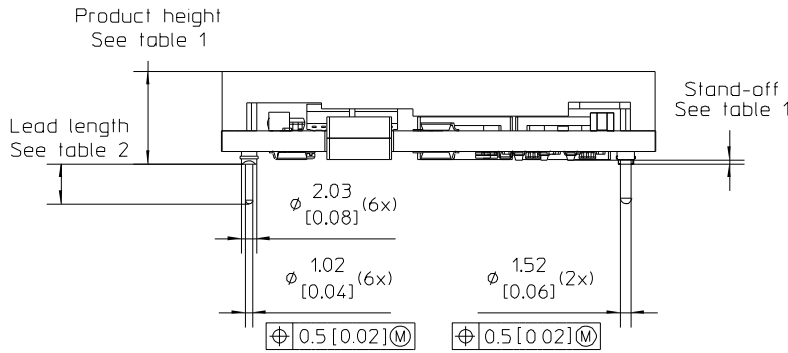

TOP VIEW  
 Pin positions according to recommended footprint.

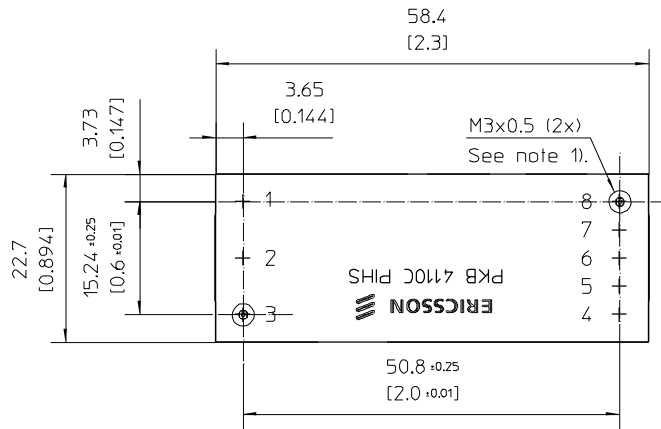

RECOMMENDED FOOTPRINT  
 TOP VIEW

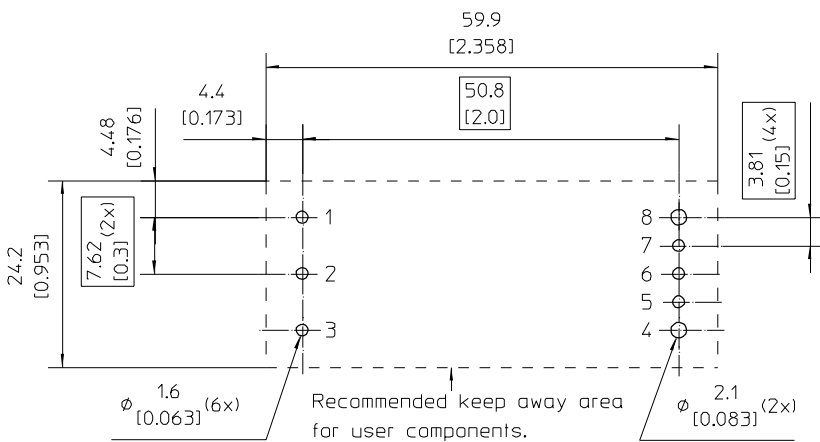

Table 1

Height option	Height	Stand-off min.
Standard	12.7 [0.5]	0.25 [0.01]
M	13.7 [0.54]	1.25 [0.05]

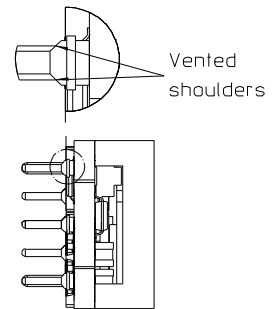

Table 2

Pin option	Lead Length
Standard	5.33 [0.21]
LA	3.69 [0.145]
LB	4.57 [0.18]

Case: Aluminium base plate  
 For screw attachment, apply mounting torque of max 0.44 Nm [3.9 lbf in]  
 1) Max screw intrusion in base plate 4 [0.16]

Pins:  
 Material:  
 Pins 1-3, 5-7: Brass  
 Pins 4,8: Copper alloy  
 Plating: 0.1 μm Au over 2 μm Ni

Weight: 40 g typical

All dimensions in mm [inch].  
 Tolerances unless specified:  
 X.x mm ±0.5 mm [0.02]  
 X.xx mm ±0.25 mm [0.01]  
 (not applied on footprint or typical values)

Technical Specification

**PKB 4000C Series DC-DC Converters**  
 Input 36-75 V, Output up to 60 A / 144 W

EN/LZT 146 377 R5A November 2017  
 © Flex

**Soldering Information - Surface Mounting**

The surface mount version of the product is intended for convection or vapor phase reflow SnPb and Pb-free processes. To achieve a good and reliable soldering result, make sure to follow the recommendations from the solder paste supplier, to use state-of-the-art reflow equipment and reflow profiling techniques as well as the following guidelines.

A no-clean flux is recommended to avoid entrapment of cleaning fluids in cavities inside the product or between the product and the host board. The cleaning residues may affect long time reliability and isolation voltage.

**Minimum Pin Temperature Recommendations**

Pin number 4 is chosen as reference location for the minimum pin temperature recommendations since this will likely be the coolest solder joint during the reflow process.

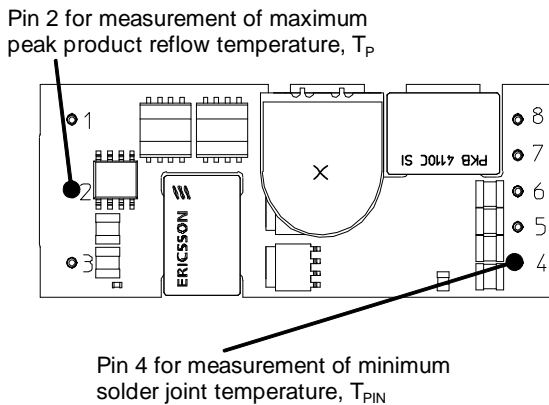

**SnPb solder processes**

For SnPb solder processes, a pin temperature ( $T_{PIN}$ ) in excess of the solder melting temperature, ( $T_L$ , +183°C for Sn63/Pb37) for more than 30 seconds, and a peak temperature of +210°C is recommended to ensure a reliable solder joint.

**Lead-free (Pb-free) solder processes**

For Pb-free solder processes, a pin temperature ( $T_{PIN}$ ) in excess of the solder melting temperature ( $T_L$ , +217 to +221°C for Sn/Ag/Cu solder alloys) for more than 30 seconds, and a peak temperature of +235°C on all solder joints is recommended to ensure a reliable solder joint.

**Peak Product Temperature Requirements**

Pin number 2 is chosen as reference location for the maximum (peak) allowed product temperature ( $T_P$ ) since this will likely be the warmest part of the product during the reflow process.

To avoid damage or performance degradation of the product, the reflow profile should be optimized to avoid excessive heating. A sufficiently extended preheat time is recommended to ensure an even temperature across the host PCB, for both small and large devices. To reduce the risk of excessive heating is also recommended to reduce the time in the reflow zone as much as possible.

**SnPb solder processes**

For SnPb solder processes, the product is qualified for MSL 1 according to IPC/JEDEC standard J-STD-020C.

During reflow,  $T_P$  must not exceed +225°C at any time.

**Lead-free (Pb-free) solder processes**

For Pb-free solder processes, the product is qualified for MSL 3 according to IPC/JEDEC standard J-STD-020C.

During reflow,  $T_P$  must not exceed +260°C at any time.

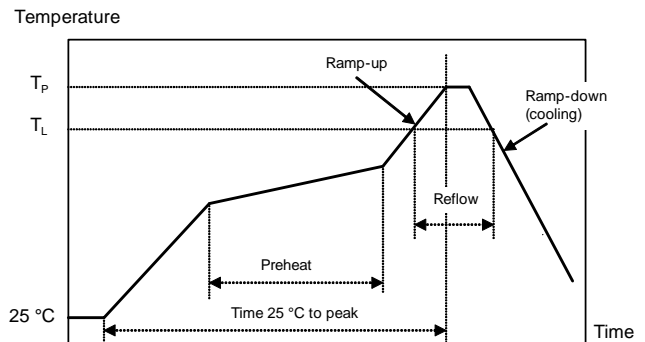

Reflow process specifications		Sn/Pb eutectic	Pb-free
Average ramp-up rate		3°C/s max	3°C/s max
Solder melting temperature (typical)	$T_L$	+183°C	+221°C
Minimum time above $T_L$		30 s	30 s
Minimum pin temperature	$T_{PIN}$	+210°C	+235°C
Peak product temperature	$T_P$	+225°C	+260°C
Average ramp-down rate		6°C/s max	6°C/s max
Time 25°C to peak		6 minutes max	8 minutes max

Technical Specification

**PKB 4000C Series DC-DC Converters**  
 Input 36-75 V, Output up to 60 A / 144 W

EN/LZT 146 377 R5A November 2017  
 © Flex

**Soldering Information – Through Hole Mounting**

The through hole mount version of the product is intended for manual or wave soldering. When wave soldering is used, the temperature on the pins is specified to maximum 270°C for maximum 10 seconds.

A maximum preheat rate of 4°C/s and a temperature of max +150°C is suggested. When soldering by hand, care should be taken to avoid direct contact between the hot soldering iron tip and the pins for more than a few seconds in order to prevent overheating.

A no-clean flux is recommended to avoid entrapment of cleaning fluids in cavities inside the product or between the product and the host board. The cleaning residues may affect long time reliability and isolation voltage.

**Delivery Package Information, Surface Mount Version**

The surface mount versions of the products are delivered in antistatic injection molded trays (Jedec design guide 4.10D standard).

Tray Specifications	
Material	PPE, Antistatic
Surface resistance	$10^5 < \text{Ohm/square} < 10^{12}$
Bakability	The trays can be baked at maximum 125°C for 48 hours
Tray capacity	20 products/tray
Tray thickness	14.4 mm [0.567 inch]
Box capacity	100 products (5 full trays/box)
Tray weight	110 g empty, 530 g full tray

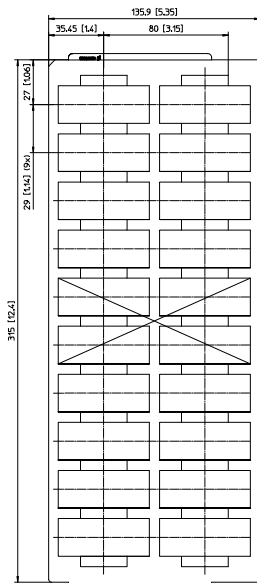

X = Vacuum pickup area.

**Dry Pack Information**

The surface mount versions of the products are delivered in trays. These inner shipment containers are dry packed in standard moisture barrier bags according to IPC/JEDEC standard J-STD-033 (Handling, packing, shipping and use of moisture/reflow sensitivity surface mount devices).

Using products in high temperature Pb-free soldering processes requires dry pack storage and handling. In case the products have been stored in an uncontrolled environment and no longer can be considered dry, the modules must be baked according to J-STD-033.

**Delivery Package Information, Through Hole versions**

The products are delivered in antistatic trays.

Tray Specifications	
Material	PE foam, antistatic.
Surface resistance	$10^5 < \text{Ohm/square} < 10^{12}$
Bakability	The trays are not bakable
Tray capacity	25 products/tray
Tray thickness Open Frame version	18 mm [0.71 inch]
Tray thickness Base Plate version	22 mm [0.87 inch]
Box capacity Open Frame version	100 products (4 full trays/box)
Box capacity Base Plate version	50 products (2 full trays/box)
Tray weight Open Frame version	30 g empty, 550 g full tray
Tray weight Base Plate version	40 g empty, 1040 g full tray

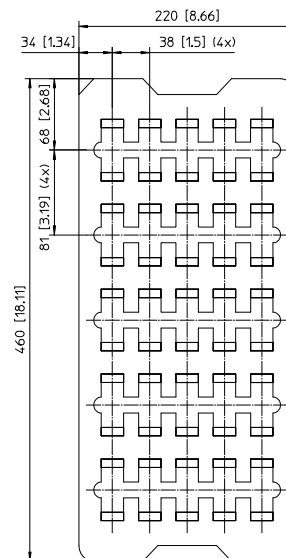

## Technical Specification

<b>PKB 4000C Series DC-DC Converters</b> Input 36-75 V, Output up to 60 A / 144 W	EN/LZT 146 377 R5A	November 2017
	© Flex	

## Product Qualification Specification



Characteristics			
External visual inspection	IPC-A-610		
Change of temperature (Temperature cycling)	IEC 60068-2-14 Na	Temperature range Number of cycles Dwell/transfer time	-40 to +100°C 1000 15 min/0-1 min
Cold (in operation)	IEC 60068-2-1 Ad	Temperature T <sub>A</sub> Duration	-45°C 72 h
Damp heat	IEC 60068-2-67 Cy	Temperature Humidity Duration	+85°C 85 % RH 1000 hours
Dry heat	IEC 60068-2-2 Bd	Temperature Duration	+125°C 1000 h
Electrostatic discharge susceptibility	IEC 61340-3-1, JESD 22-A114 IEC 61340-3-2, JESD 22-A115	Human body model (HBM) Machine Model (MM)	Class 2, 2000 V Class 3, 200 V
Immersion in cleaning solvents	IEC 60068-2-45 XA Method 2	Water Glycol ether Isopropyl alcohol	+55°C +35°C +35°C
Mechanical shock	IEC 60068-2-27 Ea	Peak acceleration Duration	100 g 6 ms
Moisture reflow sensitivity <sup>1</sup>	J-STD-020C	Level 1 (SnPb-eutectic) Level 3 (Pb Free)	225°C 260°C
Operational life test	MIL-STD-202G method 108A	Duration	1000 h
Resistance to soldering heat <sup>2</sup>	IEC 60068-2-20 Tb Method 1A	Solder temperature Duration	270°C 10-13 s
Robustness of terminations	IEC 60068-2-21 Test Ua1 IEC 60068-2-21 Test Ue1	Through hole mount products Surface mount products	All leads All leads
Solderability	IEC 60068-2-58 test Td <sup>1</sup>  IEC 60068-2-20 test Ta <sup>2</sup>	Preconditioning Temperature, SnPb Eutectic Temperature, Pb-free  Preconditioning Temperature, SnPb Eutectic Temperature, Pb-free	150°C dry bake 16 h 215°C 235°C  Steam ageing 235°C 245°C
Vibration, broad band random	IEC 60068-2-64 Fh, method 1	Frequency Spectral density Duration	10 to 500 Hz 0.07 g <sup>2</sup> /Hz 10 min in each perpendicular direction

Note 1: Only for products intended for reflow soldering (surface mount products)







Note 2: Only for products intended for wave soldering (plated through hole products)

## Looking for pricing, stock, or lifecycle information?

Click below to explore more details on WIN SOURCE:

-  [View PKB4111CPI on WIN SOURCE](#)
-  [Flex Power Modules Information](#)

## Optimize Your Supply Chain with WIN SOURCE Solutions

-  Global Sourcing Solution
-  Obsolete Management
-  Cost Control Management
-  Shortage Management
-  Alternative Solution
-  Excess Inventory Management