



THE DATASHEET OF PK55FG160



THYRISTOR MODULE

PK(PD,PE)55FG

UL:E76102(M)

Power Thyristor/Diode Module PK55FG series are designed for various rectifier circuits and power controls. For your circuit application, following internal connections and wide voltage ratings up to 1600V are available. and electrically isolated mounting base make your mechanical design easy.

- $I_{T(AV)}$ 55A, $I_{T(RMS)}$ 86A, I_{TSM} 1300A
- di/dt 100A/ μ s
- dv/dt 1000V/ μ s

(Applications)

Various rectifiers
AC/DC motor drives
Heater controls
Light dimmers
Static switches

Internal Configurations

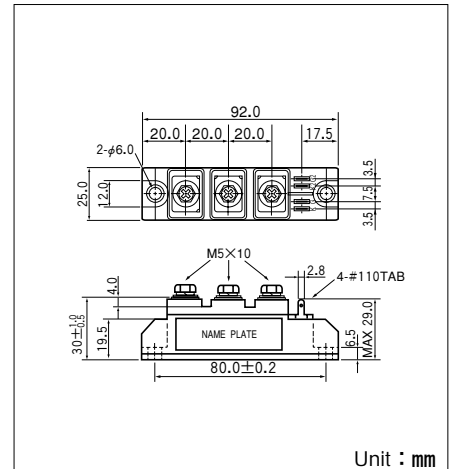
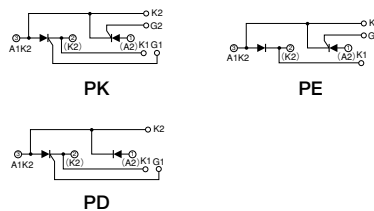

Unit : mm

Maximum Ratings

($T_j=25^\circ\text{C}$ unless otherwise specified)

Symbol	Item	Ratings				Unit
		PK55FG40 PD55FG40 PE55FG40	PK55FG80 PD55FG80 PE55FG80	PK55FG120 PD55FG120 PE55FG120	PK55FG160 PD55FG160 PE55FG160	
V_{RRM}	* Repetitive Peak Reverse Voltage	400	800	1200	1600	V
V_{RSM}	* Non-Repetitive Peak Reverse Voltage	480	960	1300	1700	V
V_{DRM}	* Repetitive Peak off-state Voltage	400	800	1200	1600	V

Symbol	Item	Conditions	Ratings	Unit	
$I_{T(AV)}$	* Average On-state Current	Single phase, half wave, 180° conduction, $T_c=81^\circ\text{C}$	55	A	
$I_{T(RMS)}$	* R.M.S. On-state Current	Single phase, half wave, 180° conduction, $T_c=81^\circ\text{C}$	86	A	
I_{TSM}	* Surge On-state Current	$\frac{1}{2}$ Cycle, 50/60Hz, Peak Value, non-repetitive	1190/1300	A	
I^2t	* I^2t	Value for one cycle surge current	7040	A^2S	
P_{GM}	Peak Gate Power Dissipation		10	W	
$P_{G(AV)}$	Average Gate Power Dissipation		1	W	
I_{FGM}	Peak Gate Current		3	A	
V_{FGM}	Peak Gate Voltage (Forward)		10	V	
V_{RGM}	Peak Gate Voltage (Reverse)		5	V	
di/dt	Critical Rate of Rise of On-state Current	$I_G=100\text{mA}$, $V_D=\frac{1}{2}V_{DRM}$, $di_G/dt=0.1\text{A}/\mu\text{s}$	100	$\text{A}/\mu\text{s}$	
V_{ISO}	* Isolation Breakdown Voltage (R.M.S)	A.C. 1minute	2500	V	
T_j	* Operating Junction Temperature		-40 to +125	$^\circ\text{C}$	
T_{stg}	* Storage Temperature		-40 to +125	$^\circ\text{C}$	
	Mounting Torque	Mounting (M5)	Recommended Value 1.5-2.5 (15-25)	2.7 (28)	$\text{N}\cdot\text{m}$ ($\text{kgf}\cdot\text{cm}$)
		Terminal (M5)	Recommended Value 1.5-2.5 (15-25)	2.7 (28)	
	Mass	Typical Value	170	g	

Electrical Characteristics

Symbol	Item	Conditions	Ratings	Unit
I_{DRM}	Repetitive Peak off-state Current,max	$T_j=125^\circ\text{C}$, $V_D=V_{DRM}$	15	mA
I_{RRM}	* Repetitive Peak Reverse Current,max	$T_j=125^\circ\text{C}$, $V_D=V_{DRM}$	15	mA
V_{TM}	* On-state Voltage,max	$I_T=165\text{A}$	1.6	V
I_{GT}	Gate Trigger Current,max	$V_D=6\text{V}$, $I_T=1\text{A}$	50	mA
V_{GT}	Gate Trigger Voltage,max	$V_D=6\text{V}$, $I_T=1\text{A}$	3	V
V_{GD}	Gate Trigger Voltage,min	$T_j=125^\circ\text{C}$, $V_D=\frac{1}{2}V_{DRM}$	0.25	V
dv/dt	Critical Rate of Rise of off-state Voltage,min	$T_j=125^\circ\text{C}$, $V_D=\frac{2}{3}V_{DRM}$	1000	$\text{V}/\mu\text{s}$
$R_{th(j-c)}$	* Thermal Impedance,max	Junction to case	0.5	$^\circ\text{C}/\text{W}$

* mark : Thyristor and Diode part. No mark : Thyristor part

Gate Characteristics

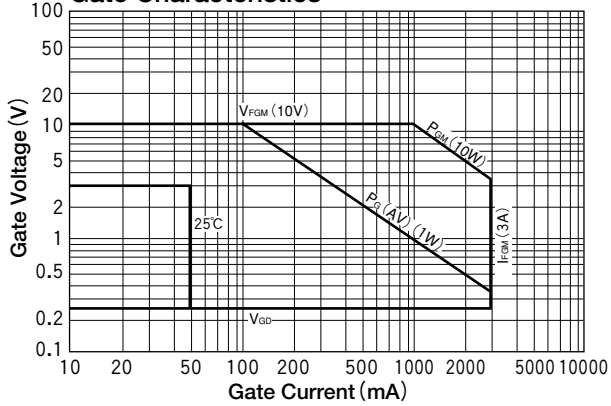

On-State Voltage max

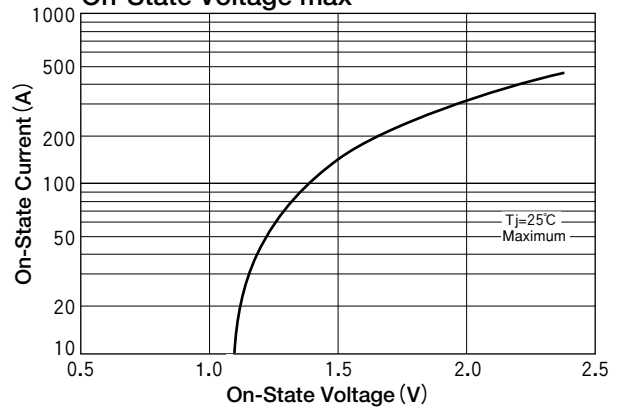

Surge On-State Current Rating (Non-Repetitive)

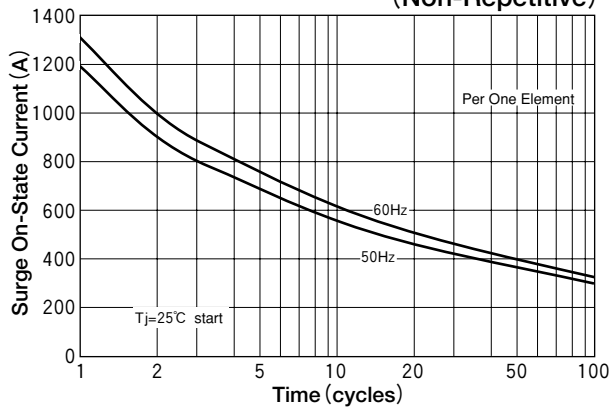

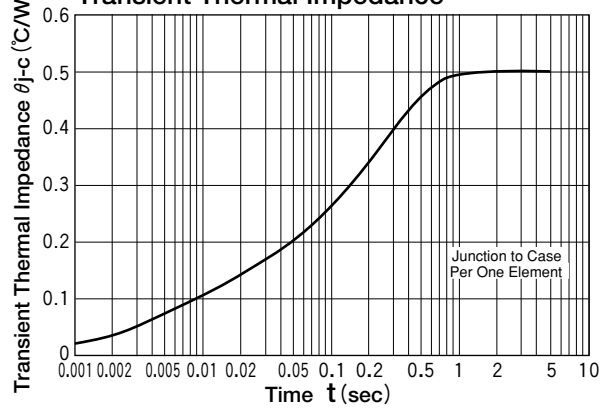

Transient Thermal Impedance



Looking for pricing, stock, or lifecycle information?

Click below to explore more details on WIN SOURCE:

-  [View PK55FG160 on WIN SOURCE](#)
-  [SanRex Corporation](#) Information

Optimize Your Supply Chain with WIN SOURCE Solutions

-  Global Sourcing Solution
-  Obsolete Management
-  Cost Control Management
-  Shortage Management
-  Alternative Solution
-  Excess Inventory Management