



**THE DATASHEET OF
PIC16C54C-04/SS**



MOSFET

Metal Oxide Semiconductor Field Effect Transistor

CoolMOS™ C6 600V

600V CoolMOS™ C6 Power Transistor
IPD60R3K3C6

Data Sheet

Rev. 2.4
Final

Industrial & Multimarket

1 Description

CoolMOS™ is a revolutionary technology for high voltage power MOSFETs, designed according to the superjunction (SJ) principle and pioneered by Infineon Technologies. CoolMOS™ C6 series combines the experience of the leading SJ MOSFET supplier with high class innovation. The resulting devices provide all benefits of a fast switching SJ MOSFET while not sacrificing ease of use. Extremely low switching and conduction losses make switching applications even more efficient, more compact, lighter, and cooler.

Features

- Extremely low losses due to very low FOM $R_{DS(on)} \cdot Q_g$ and E_{oss}
- Very high commutation ruggedness
- Easy to use/drive
- Fully qualified according to JEDEC for Industrial Applications
- Halogen free mold compound, Pb-free plating

Applications

PFC stages, hard switching PWM stages and resonant switching PWM stages for e.g. PC Silverbox, Adapter, LCD & PDP TV, Lighting, Server, Telecom and UPS.

Please note:

For MOSFET paralleling the use of ferrite beads on the gate or separate totem poles is generally recommended.

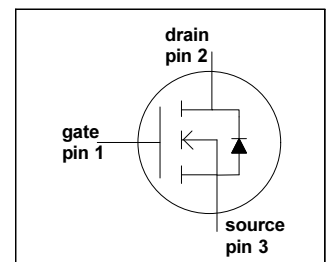
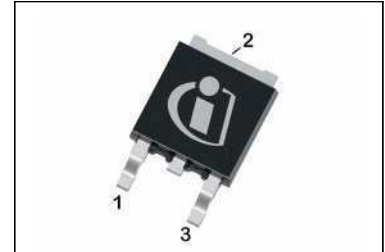

Table 1 Key Performance Parameters

| Parameter | Value | Unit |
|----------------------|-------|------------|
| $V_{DS} @ T_{j,max}$ | 650 | V |
| $R_{DS(on),max}$ | 3.3 | Ω |
| $Q_{g,typ}$ | 4.6 | nC |
| $I_{D,pulse}$ | 4 | A |
| $E_{oss} @ 400V$ | 0.57 | μJ |
| Body diode di/dt | 500 | A/ μs |

| Type / Ordering Code | Package | Marking | Related Links |
|----------------------|----------|---------|---|
| IPD60R3K3C6 | PG-TO252 | 6R3K3C6 | IFX C6 Product Brief IFX C6 Portfolio IFX CoolMOS Webpage IFX Design tools |

Table of Contents

| | | |
|---|---|----|
| 1 | Description | 2 |
| | Table of Contents | 3 |
| 2 | Maximum Ratings | 4 |
| 3 | Thermal characteristics | 5 |
| 4 | Electrical characteristics | 6 |
| 5 | Electrical characteristics diagrams | 8 |
| 6 | Test circuits | 12 |
| 7 | Package outlines | 13 |
| 8 | Revision History | 14 |

2 Maximum Ratings

at $T_j = 25\text{ °C}$, unless otherwise specified.

Table 2 Maximum ratings

| Parameter | Symbol | Values | | | Unit | Note / Test Condition |
|---|----------------|--------|------|------|------------|--|
| | | Min. | Typ. | Max. | | |
| Continuous drain current ¹⁾ | I_D | - | - | 1.7 | A | $T_C = 25\text{ °C}$ |
| | | | | 1.1 | | $T_C = 100\text{ °C}$ |
| Pulsed drain current ²⁾ | $I_{D,pulse}$ | - | - | 4 | A | $T_C = 25\text{ °C}$ |
| Avalanche energy, single pulse | E_{AS} | - | - | 6 | mJ | $I_D = 0.3\text{ A}, V_{DD} = 50\text{ V}$ (see table 17) |
| Avalanche energy, repetitive | E_{AR} | - | - | 0.04 | | $I_D = 0.3\text{ A}, V_{DD} = 50\text{ V}$ |
| Avalanche current, repetitive | I_{AR} | - | - | 0.3 | A | |
| MOSFET dv/dt ruggedness | dv/dt | - | - | 50 | V/ns | $V_{DS} = 0 \dots 480\text{ V}$ |
| Gate source voltage | V_{GS} | -20 | - | 20 | V | static |
| | | -30 | | 30 | | AC ($f > 1\text{ Hz}$) |
| Power dissipation | P_{tot} | - | - | 18.1 | W | $T_C = 25\text{ °C}$ |
| Operating and storage temperature | T_j, T_{stg} | -55 | - | 150 | °C | |
| Continuous diode forward current | I_S | - | - | 1.5 | A | $T_C = 25\text{ °C}$ |
| Diode pulse current ²⁾ | $I_{S,pulse}$ | - | - | 4 | A | $T_C = 25\text{ °C}$ |
| Reverse diode dv/dt ³⁾ | dv/dt | - | - | 15 | V/ns | $V_{DS} = 0 \dots 480\text{ V}, I_{SD} \leq I_D,$ $T_j = 125\text{ °C}$ |
| Maximum diode commutation speed ³⁾ | di/dt | | | 500 | A/ μ s | (see table 18) |

1) Limited by $T_{j,max}$. Maximum duty cycle $D = 0.75$

2) Pulse width t_p limited by $T_{j,max}$

3) Identical low side and high side switch with identical R_G

3 Thermal characteristics

Table 3 Thermal characteristics

| Parameter | Symbol | Values | | | Unit | Note / Test Condition |
|--|------------|--------|------|------|------|---|
| | | Min. | Typ. | Max. | | |
| Thermal resistance, junction - case | R_{thJC} | - | - | 6.9 | °C/W | |
| Thermal resistance, junction - ambient | R_{thJA} | - | - | 62 | | SMD version, device on PCB, minimal footprint |
| | | | 35 | | | SMD version, device on PCB, 6cm ² cooling area ¹⁾ |
| Soldering temperature, wave- & reflowsoldering allowed | T_{sold} | - | - | 260 | °C | reflow MSL1 |

1) Device on 40mm*40mm*1.5 epoxy PCB FR4 with 6cm² (one layer, 70µm thick) copper area for drain connection. PCB is vertical without air stream cooling

4 Electrical characteristics

Electrical characteristics, at $T_J=25\text{ °C}$, unless otherwise specified

Table 4 Static characteristics

| Parameter | Symbol | Values | | | Unit | Note / Test Condition |
|----------------------------------|---------------|--------|------|------|---------------|--|
| | | Min. | Typ. | Max. | | |
| Drain-source breakdown voltage | $V_{(BR)DSS}$ | 600 | - | - | V | $V_{GS}=0\text{ V}$, $I_D=0.25\text{ mA}$ |
| Gate threshold voltage | $V_{GS(th)}$ | 2.5 | 3 | 3.5 | | $V_{DS}=V_{GS}$, $I_D=0.04\text{ mA}$ |
| Zero gate voltage drain current | I_{DSS} | - | - | 1 | μA | $V_{DS}=600\text{ V}$, $V_{GS}=0\text{ V}$, $T_J=25\text{ °C}$ |
| | | - | 10 | - | | $V_{DS}=600\text{ V}$, $V_{GS}=0\text{ V}$, $T_J=150\text{ °C}$ |
| Gate-source leakage current | I_{GSS} | - | - | 100 | nA | $V_{GS}=20\text{ V}$, $V_{DS}=0\text{ V}$ |
| Drain-source on-state resistance | $R_{DS(on)}$ | - | 2.97 | 3.3 | Ω | $V_{GS}=10\text{ V}$, $I_D=0.5\text{ A}$, $T_J=25\text{ °C}$ |
| | | - | 7.72 | - | | $V_{GS}=10\text{ V}$, $I_D=0.5\text{ A}$, $T_J=150\text{ °C}$ |
| Gate resistance | R_G | - | 15 | - | Ω | $f=1\text{ MHz}$, open drain |

Table 5 Dynamic characteristics

| Parameter | Symbol | Values | | | Unit | Note / Test Condition |
|--|--------------|--------|------|------|------|--|
| | | Min. | Typ. | Max. | | |
| Input capacitance | C_{iss} | - | 93 | - | pF | $V_{GS}=0\text{ V}$, $V_{DS}=100\text{ V}$, $f=1\text{ MHz}$ |
| Output capacitance | C_{oss} | - | 9 | - | | |
| Effective output capacitance, energy related ¹⁾ | $C_{o(er)}$ | - | 6.4 | - | | |
| Effective output capacitance, time related ²⁾ | $C_{o(tr)}$ | - | 21 | - | | |
| Turn-on delay time | $t_{d(on)}$ | - | 8 | - | ns | $V_{DD}=400\text{ V}$, $V_{GS}=10\text{ V}$, $I_D=0.6\text{ A}$, $R_G=20\text{ }\Omega$ (see table 16) |
| Rise time | t_r | - | 10 | - | | |
| Turn-off delay time | $t_{d(off)}$ | - | 40 | - | | |
| Fall time | t_f | - | 60 | - | | |

1) $C_{o(er)}$ is a fixed capacitance that gives the same stored energy as C_{oss} while V_{DS} is rising from 0 to 80% $V_{(BR)DSS}$

2) $C_{o(tr)}$ is a fixed capacitance that gives the same charging time as C_{oss} while V_{DS} is rising from 0 to 80% $V_{(BR)DSS}$

Table 6 Gate charge characteristics

| Parameter | Symbol | Values | | | Unit | Note / Test Condition |
|-----------------------|---------------|--------|------|------|------|--|
| | | Min. | Typ. | Max. | | |
| Gate to source charge | Q_{gs} | - | 0.5 | - | nC | $V_{DD}=480\text{ V}$, $I_D=0.6\text{ A}$, $V_{GS}=0\text{ to }10\text{ V}$ |
| Gate to drain charge | Q_{gd} | - | 2.6 | - | | |
| Gate charge total | Q_g | - | 4.6 | - | | |
| Gate plateau voltage | $V_{plateau}$ | - | 5.4 | - | V | |

Table 7 Reverse diode characteristics

| Parameter | Symbol | Values | | | Unit | Note / Test Condition |
|-------------------------------|-----------|--------|------|------|---------------|---|
| | | Min. | Typ. | Max. | | |
| Diode forward voltage | V_{SD} | - | 0.9 | - | V | $V_{GS}=0\text{ V}$, $I_F=0.6\text{ A}$, $T_j=25\text{ °C}$ |
| Reverse recovery time | t_{rr} | - | 160 | - | ns | $V_R=400\text{ V}$, $I_F=0.6\text{ A}$, $di_F/dt=100\text{ A}/\mu\text{s}$ (see table 18) |
| Reverse recovery charge | Q_{rr} | - | 0.42 | - | μC | |
| Peak reverse recovery current | I_{rrm} | - | 5.1 | - | A | |

5 Electrical characteristics diagrams

Table 8

| Power dissipation | Max. transient thermal impedance |
|--------------------|--|
| | |
| $P_{tot} = f(T_C)$ | $Z_{(thJC)} = f(t_p)$; parameter: $D = t_p / T$ |

Table 9

| Safe operating area $T_C = 25\text{ °C}$ | Safe operating area $T_C = 80\text{ °C}$ |
|--|--|
| | |
| $I_D = f(V_{DS})$; $T_C = 25\text{ °C}$; $D = 0$; parameter t_p | $I_D = f(V_{DS})$; $T_C = 80\text{ °C}$; $D = 0$; parameter t_p |

Table 10

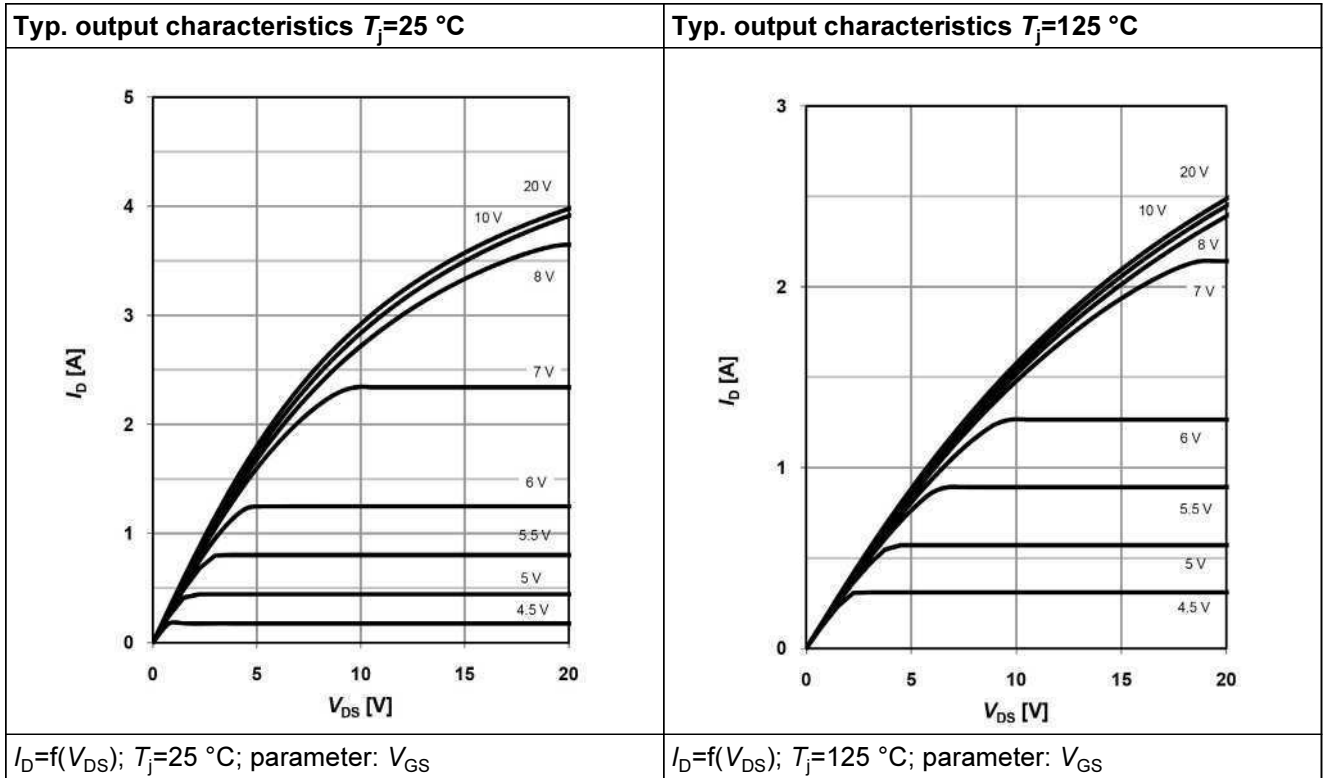

Table 11

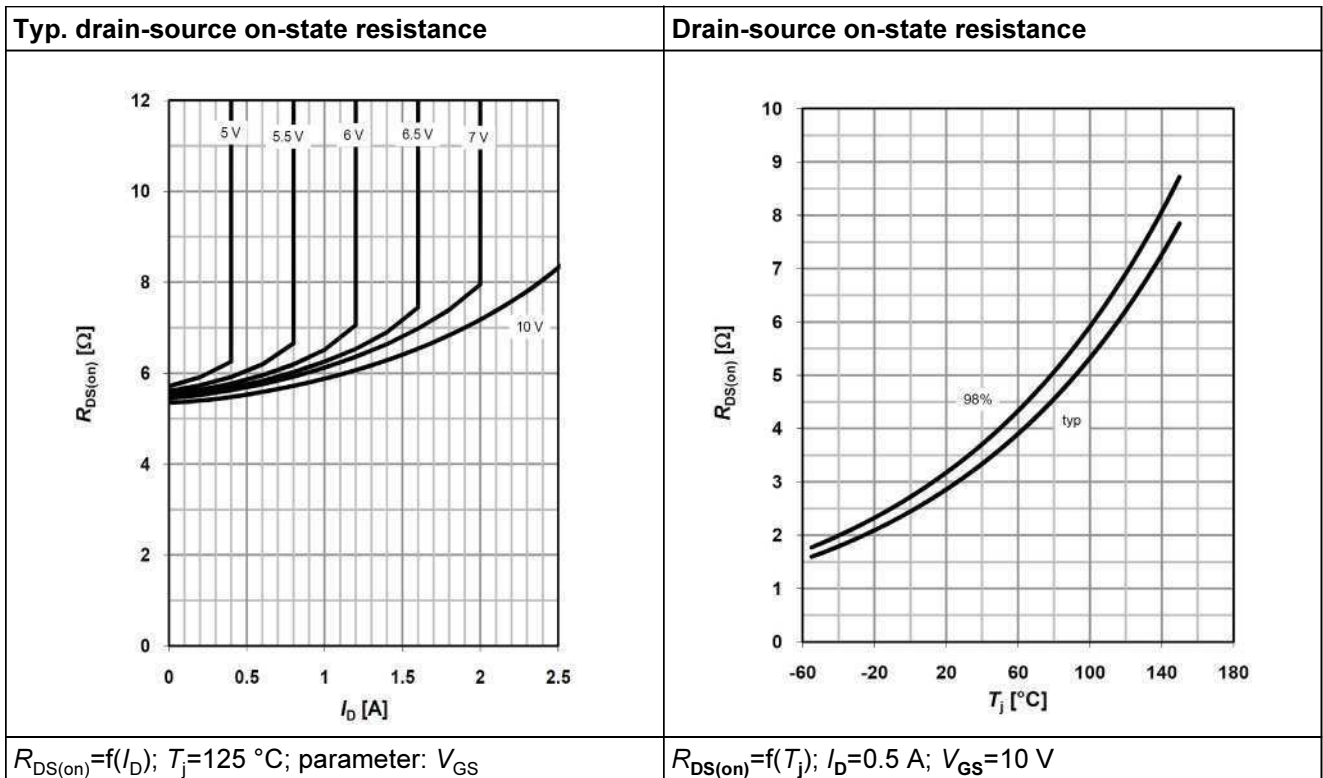

Table 12

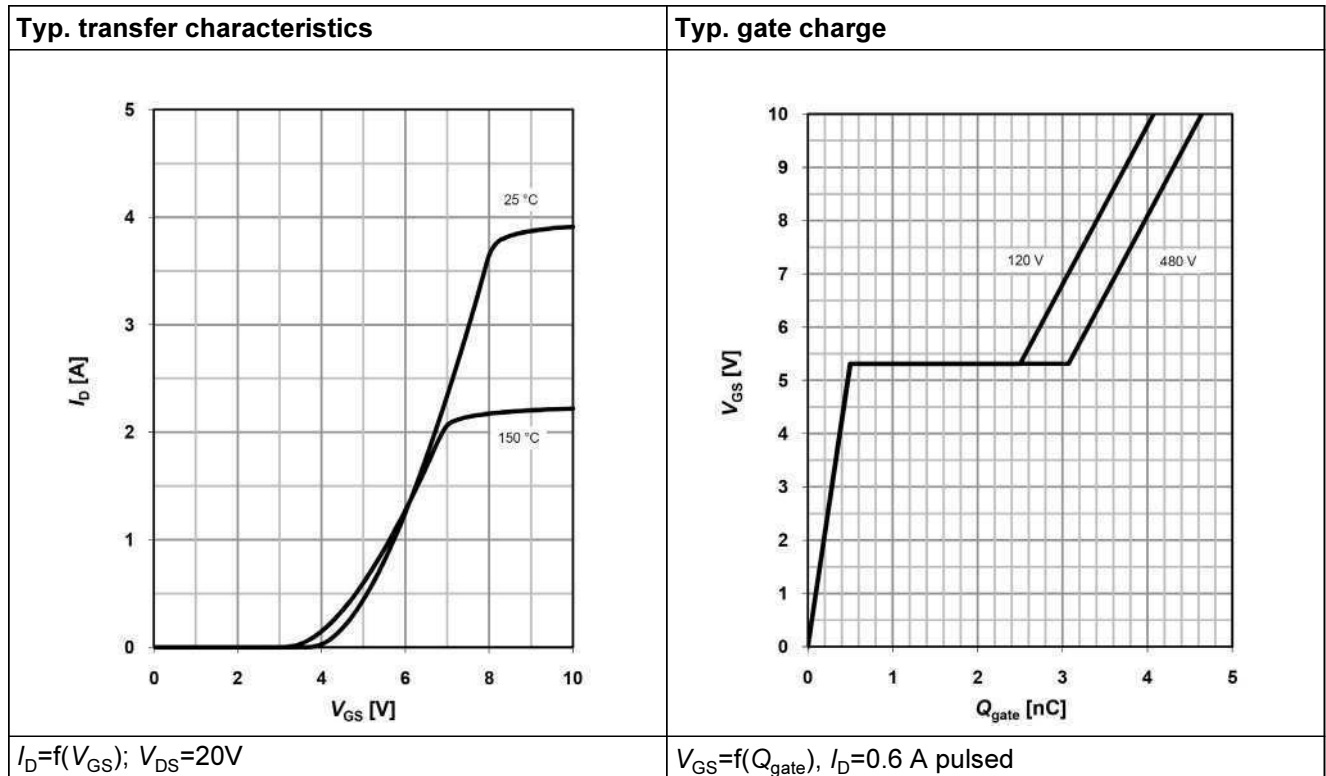

Table 13

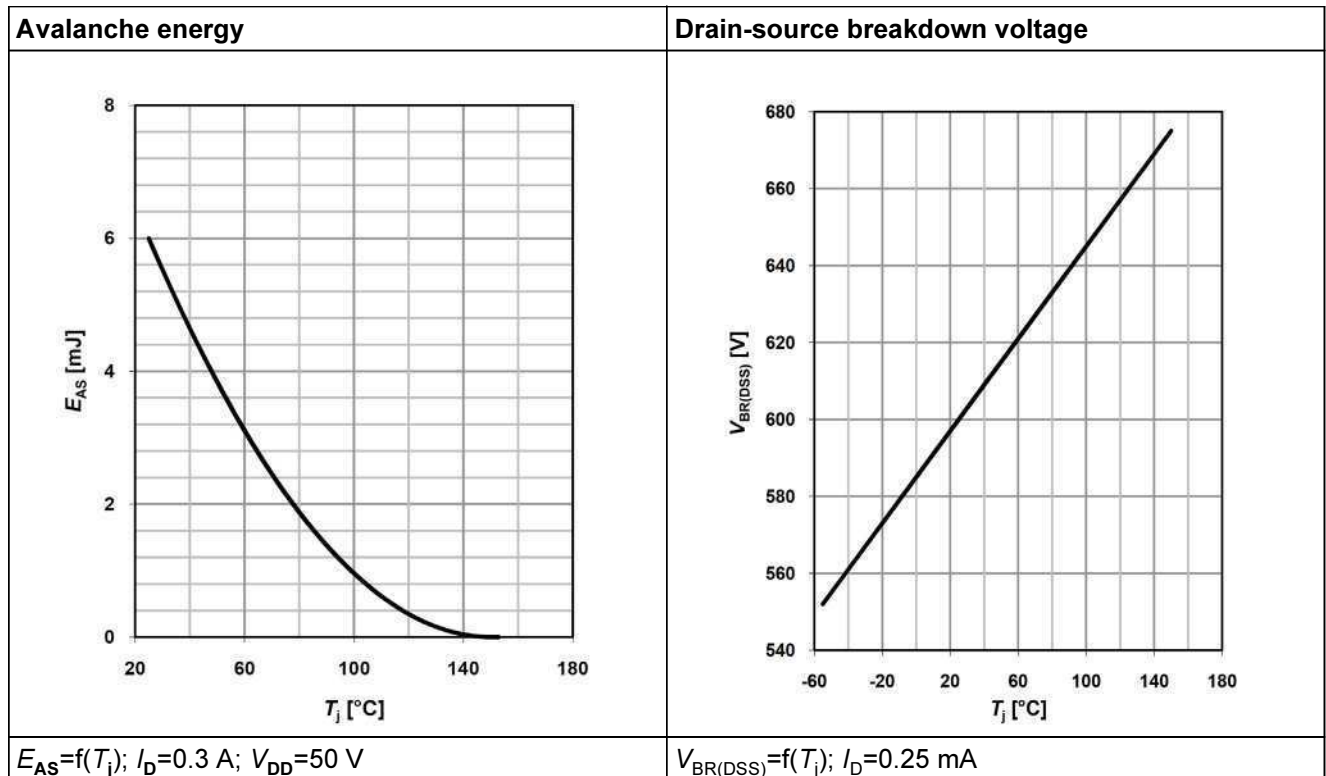

Table 14

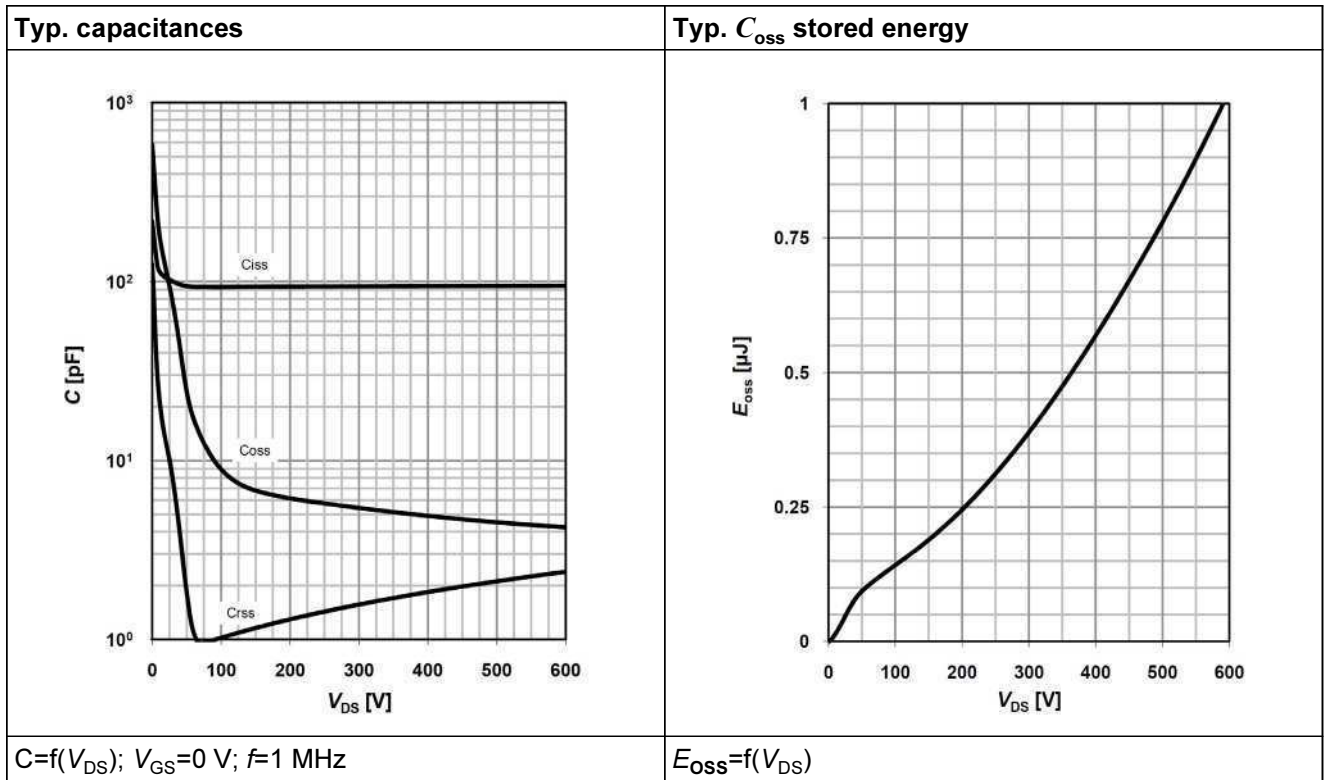
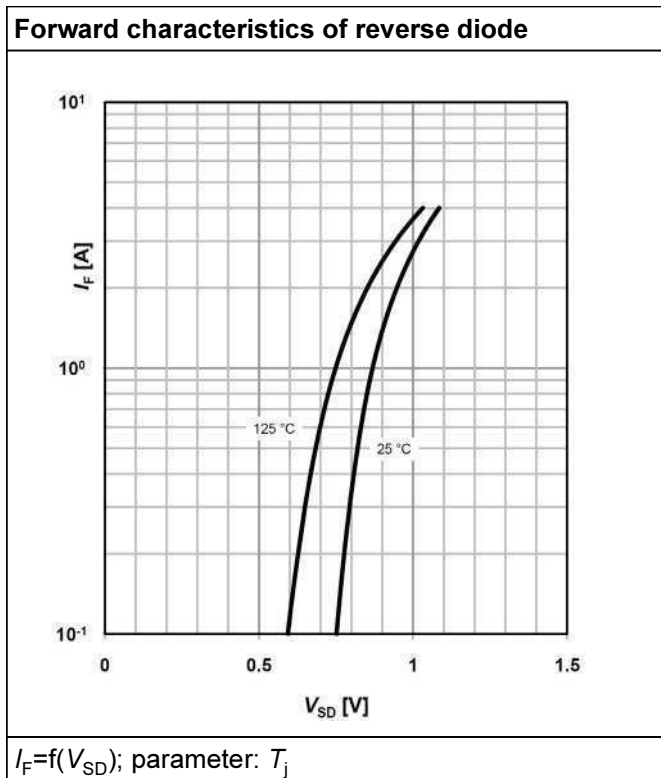

Table 15



6 Test circuits

Table 16 Switching times test circuit and waveform for inductive load

| Switching times test circuit for inductive load | Switching time waveform |
|---|-------------------------|
| | |

Table 17 Unclamped inductive load test circuit and waveform

| Unclamped inductive load test circuit | Unclamped inductive waveform |
|---------------------------------------|------------------------------|
| | |

Table 18 Test circuit and waveform for diode characteristics

| Test circuit for diode characteristics | Diode recovery waveform |
|--|-------------------------|
| | |

7 Package outlines

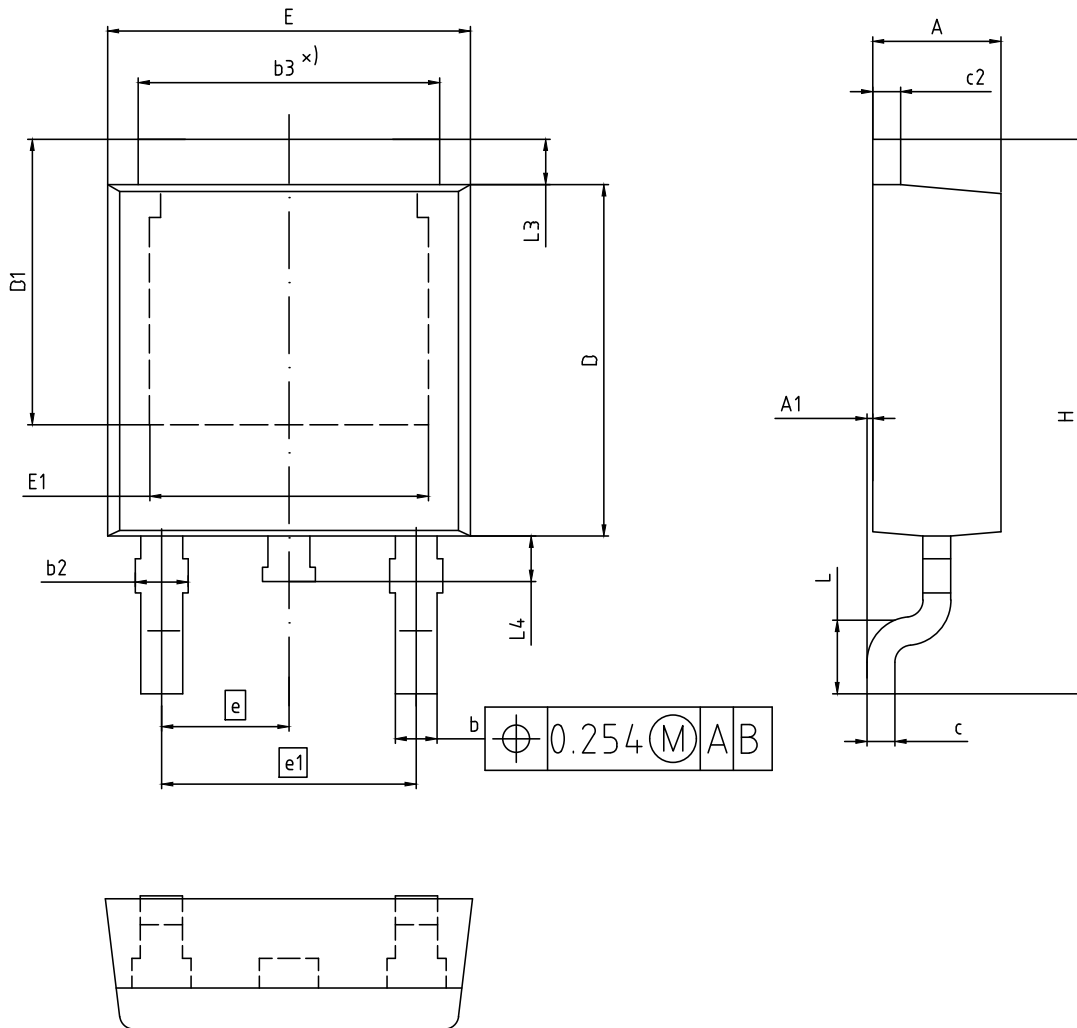

ALL DIMENSIONS REFER TO JEDEC STANDARD TO-252 AND DO NOT INCLUDE MOLD FLASH OR PROTRUSIONS.

| DIMENSION | MILLIMETERS | |
|-----------|-------------|-------|
| | MIN. | MAX. |
| A | 2.16 | 2.41 |
| A1 | 0.00 | 0.15 |
| b | 0.64 | 0.89 |
| b2 | 0.65 | 1.15 |
| b3 | 4.95 | 5.50 |
| c | 0.46 | 0.61 |
| c2 | 0.40 | 0.98 |
| D | 5.97 | 6.22 |
| D1 | 5.02 | 5.84 |
| E | 6.35 | 6.73 |
| E1 | 4.32 | 5.50 |
| e | 2.29 | |
| e1 | 4.57 | |
| N | 3 | |
| H | 9.40 | 10.48 |
| L | 1.18 | 1.78 |
| L3 | 0.89 | 1.27 |
| L4 | 0.51 | 1.02 |

| |
|-------------------------------|
| DOCUMENT NO. Z8B00003328 |
| REVISION 07 |
| SCALE: 10:1 0 1 2mm |
| EUROPEAN PROJECTION |
| ISSUE DATE 01.04.2020 |

Figure 1 Outlines TO-252, dimensions in mm

Revision History

IPD60R3K3C6

Revision: 2020-05-20, Rev. 2.4

Previous Revision

| Revision | Date | Subjects (major changes since last revision) |
|----------|------------|--|
| 2.0 | 2011-06-08 | Release of final data sheet |
| 2.1 | 2011-09-14 | - |
| 2.2 | 2015-10-09 | Add Halogen free marking |
| 2.3 | 2015-11-17 | Updated with halogen free info |
| 2.4 | 2020-05-20 | Update of the package outlines |

Trademarks

All referenced product or service names and trademarks are the property of their respective owners.

We Listen to Your Comments

Any information within this document that you feel is wrong, unclear or missing at all? Your feedback will help us to continuously improve the quality of this document. Please send your proposal (including a reference to this document) to:

erratum@infineon.com

Published by

Infineon Technologies AG

81726 München, Germany

© 2020 Infineon Technologies AG

All Rights Reserved.

Legal Disclaimer

The information given in this document shall in no event be regarded as a guarantee of conditions or characteristics ("Beschaffheitsgarantie").

With respect to any examples, hints or any typical values stated herein and/or any information regarding the application of the product, Infineon Technologies hereby disclaims any and all warranties and liabilities of any kind, including without limitation warranties of non-infringement of intellectual property rights of any third party.

In addition, any information given in this document is subject to customer's compliance with its obligations stated in this document and any applicable legal requirements, norms and standards concerning customer's products and any use of the product of Infineon Technologies in customer's applications.

The data contained in this document is exclusively intended for technically trained staff. It is the responsibility of customer's technical departments to evaluate the suitability of the product for the intended application and the completeness of the product information given in this document with respect to such application.

Information

For further information on technology, delivery terms and conditions and prices please contact your nearest Infineon Technologies Office (www.infineon.com).



Warnings

Due to technical requirements, components may contain dangerous substances. For information on the types in question, please contact the nearest Infineon Technologies Office.

The Infineon Technologies component described in this Data Sheet may be used in life-support devices or systems and/or automotive, aviation and aerospace applications or systems only with the express written approval of Infineon Technologies, if a failure of such components can reasonably be expected to cause the failure of that life-support, automotive, aviation and aerospace device or system or to affect the safety or effectiveness of that device or system. Life support devices or systems are intended to be implanted in the human body or to support and/or maintain and sustain and/or protect human life. If they fail, it is reasonable to assume that the health of the user or other persons may be endangered.

Looking for pricing, stock, or lifecycle information?

Click below to explore more details on WIN SOURCE:

-  [View PIC16C54C-04/SS on WIN SOURCE](#)
-  [Microchip Technology Information](#)

Optimize Your Supply Chain with WIN SOURCE Solutions

-  Global Sourcing Solution
-  Obsolete Management
-  Cost Control Management
-  Shortage Management
-  Alternative Solution
-  Excess Inventory Management