



**THE DATASHEET OF  
PE-68627T**



# COMMON MODE CHOKE CATALOG

Suited for LAN and Telecom Applications



**Pulse**  
A TECHNITROL COMPANY

## *TABLE of CONTENTS*





### **Common Mode Chokes for Datacom Applications**

Surface Mount Common Mode Chokes .....	2-6
Through Hole Common Mode Chokes .....	7-12

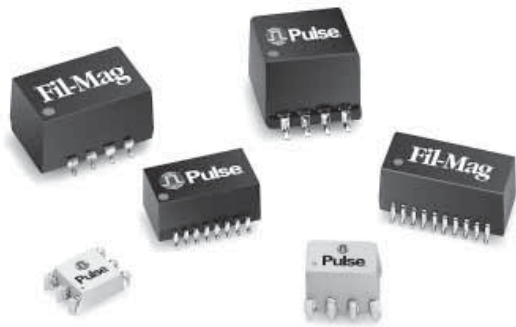
# SURFACE MOUNT COMMON MODE CHOKES

## Suited for LAN and Telecom Applications



-  Reduces radiated EMI emissions
-  Filters common mode noise for EMI reduction
-  Common mode attenuation from 100 kHz to 1 GHz
-  Tape & Reel packaging available for surface mount parts\*

### Electrical Specifications @ 25°C

Part Number	No. of Ports	Primary Inductance OCL (μH MIN)	Common Mode Attenuation (db TYP)									DCR (Ω MAX)	Page Number Mech & Schem
			100 KHz	1 MHz	10 MHz	30 MHz	50 MHz	100 MHz	300 MHz	500 MHz	1 GHz		
PE-68624	2	47	11	27	40	44	42	36	26	17	—	0.40	2
PE-65855	2	4700	41	43	49	39	34	26	20	20	12	1.0	4
B2013	2	6300	46	47	43	32	25	29	21	14	16	1.0	3
B4003	2	4700	42	41	48	38	33	21	22	23	17	1.0	6
23Z87SM	3	69	9	24	31	30	29	27	21	16	—	0.20	4
PE-65857	4	22.5	7	20	30	37	38	34	24	13	—	0.22	4
PE-68627	4	24	8	21	32	36	37	36	30	20	—	0.25	4
T8003	4	33	9	13	32	32	30	27	16	17	13	0.20	6
23Z4000SMD	4	36	7	23	35	38	38	36	29	24	—	0.50	5
PE-65854	4	47	3	19	32	36	35	29	12	6	—	0.40	3
23Z104SM	4	68	8	22	28	28	27	25	20	15	—	0.20	5
PE-67540	4	100	14	33	44	48	49	44	34	29	20	0.60	4
PE-65853	4	4700	40	51	38	30	25	20	14	13	—	1.20	3
23Z106SM	6	68	8	22	29	30	30	29	24	19	—	0.20	5
PE-69011	8	36	8	24	36	39	35	29	18	11	—	0.35	3
23Z105SM	8	68	8	24	30	29	27	24	16	11	—	0.20	5
23Z109SM	10	7.5	4	9	20	25	26	24	16	11	—	0.20	5
T8008	16	47	7	27	40	44	42	36	26	—	—	0.40	6

\* When ordering Tape & Reel packaging, add a "T" at the end of the part number (i.e. PE-65738T or 23Z106SMT).

**NOTE:** Additional common mode chokes are available. Please contact Applications Engineering.

### Mechanical

### Schematic

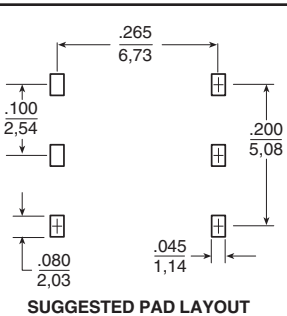
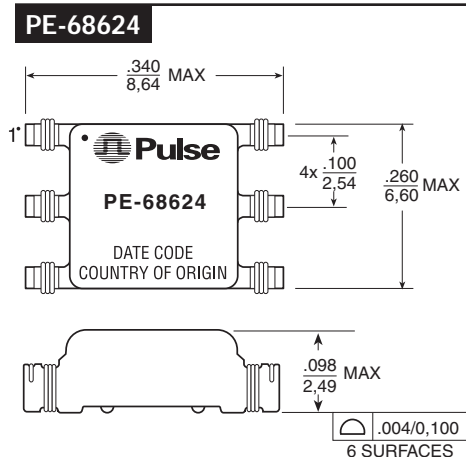

Weight . . . . . 0.17 grams  
Tape & Reel . . . . . 1500/reel  
Tube . . . . . 85/tube

# SURFACE MOUNT COMMON MODE CHOKES

Suited for LAN and Telecom Applications



## Mechanical

## Schematic

### PE-69011

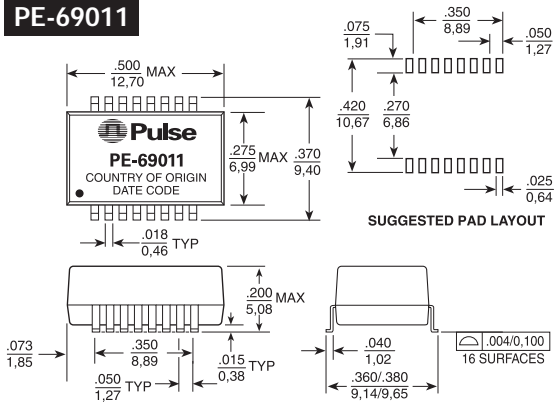

Dimensions:  $\frac{\text{Inches}}{\text{mm}}$

Unless otherwise specified,  
all tolerances are  $\pm .010$   
0,25

Weight . . . . . 0.83 grams

Tape & Reel . . . . . 900/reel

Tube . . . . . 40/tube

### PE-69011

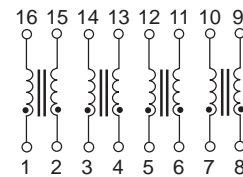

### PE-65853

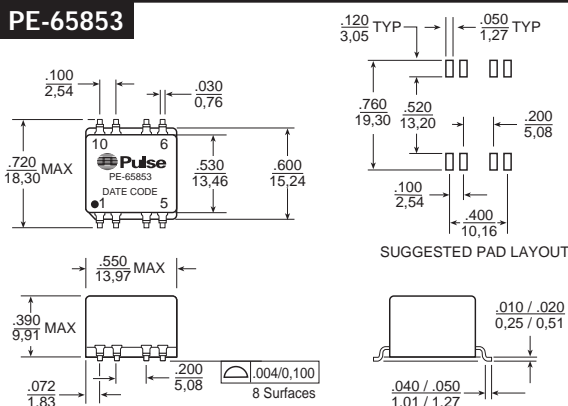

Dimensions:  $\frac{\text{Inches}}{\text{mm}}$

Unless otherwise specified,  
all tolerances are  $\pm .010$   
0,25

Weight . . . . . 4.0 grams

Tape & Reel . . . . . 150/reel

Tube . . . . . 35/tube

### PE-65853

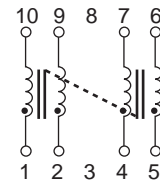

### B2013

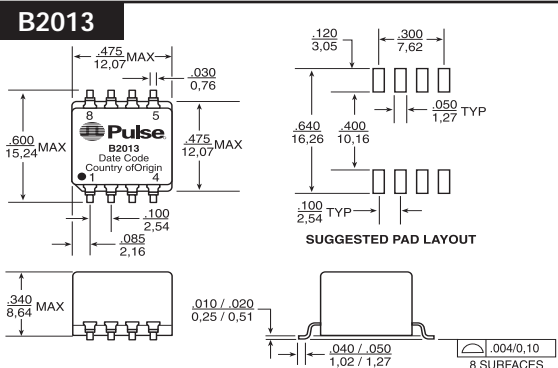

Dimensions:  $\frac{\text{Inches}}{\text{mm}}$

Unless otherwise specified,  
all tolerances are  $\pm .010$   
0,25

Weight . . . . . 9.5 grams

Tray . . . . . 30/tray

### B2013



### PE-65854

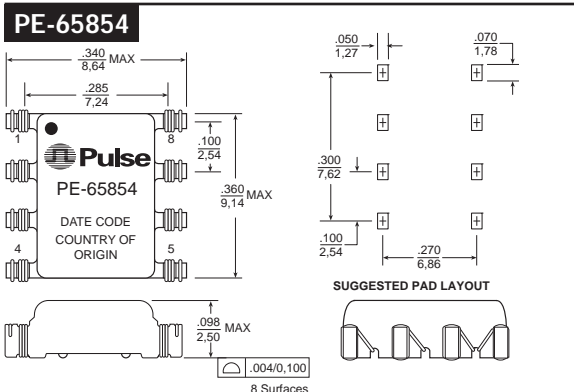

Dimensions:  $\frac{\text{Inches}}{\text{mm}}$

Unless otherwise specified,  
all tolerances are  $\pm .010$   
0,25

Weight . . . . . 0.3 grams

Tape & Reel . . . . . 1500/reel

Tube . . . . . 60/tube

### PE-65854

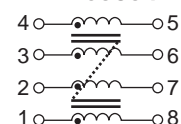

# SURFACE MOUNT COMMON MODE CHOKES

Suited for LAN and Telecom Applications



## Mechanical

## Schematic

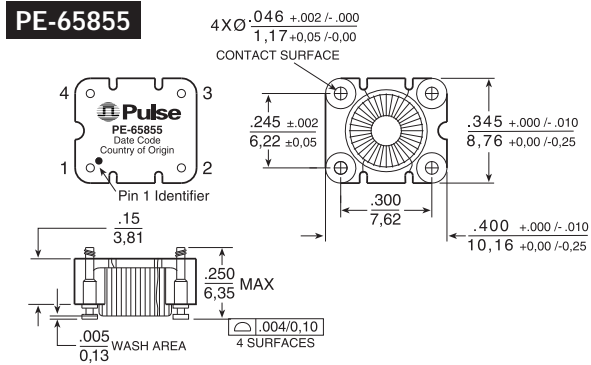

**Dimensions:** Inches  
mm

Unless otherwise specified,  
all tolerances are  $\pm .010$   
0,25

**Weight** . . . . . 0.69 grams  
**Tape & Reel** . . . . . 800/reel  
**Tube** . . . . . 40 /tube

**PE-65855**



**Dimensions:** Inches  
mm

Unless otherwise specified,  
all tolerances are  $\pm .010$   
0,25

**Weight** . . . . . 2.0 grams  
**Tape & Reel** . . . . . 250/reel  
**Tube** . . . . . 40/tube

**PE-65857**

**PE-67540**



**Dimensions:** Inches  
mm

Unless otherwise specified,  
all tolerances are  $\pm .010$   
0,25

**Weight** . . . . . 0.3 grams  
**Tape & Reel** . . . . . 1500/reel  
**Tube** . . . . . 55/tube

**PE-68627**



**Dimensions:** Inches  
mm

Unless otherwise specified,  
all tolerances are  $\pm .005$   
0,13

**Weight** . . . . . 0.5 grams  
**Tape & Reel** . . . . . 750/reel  
**Tube** . . . . . 100/tube

**23Z87SM**



# SURFACE MOUNT COMMON MODE CHOKES

Suited for LAN and Telecom Applications



Mechanical

Schematic

## 23Z104SM

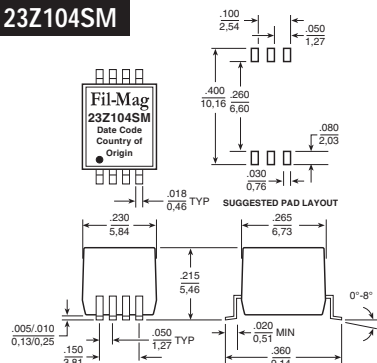

Dimensions: Inches  
mm

Unless otherwise specified,  
all tolerances are  $\pm .005$   
0,13

Weight . . . . . 0.5 grams  
Tape & Reel . . . . . 750/reel  
Tube . . . . . 100/tube

## 23Z104SM

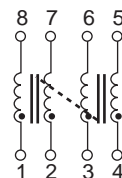

## 23Z105SM, 23Z106SM

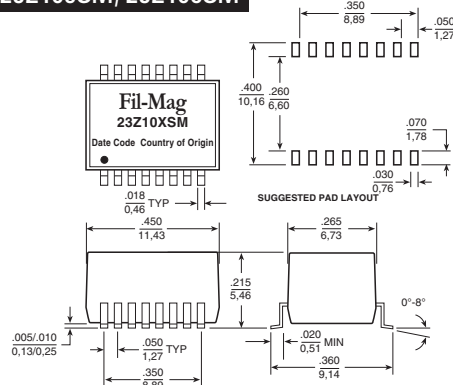

Dimensions: Inches  
mm

Unless otherwise specified,  
all tolerances are  $\pm .005$   
0,13

23Z105SM 23Z106SM  
Weight . . . . . 0.8 grams . . . . . 1.0 grams  
Tape & Reel . . . . . 750/reel . . . . . 750/reel  
Tube . . . . . 50/tube . . . . . 50/tube

## 23Z105SM

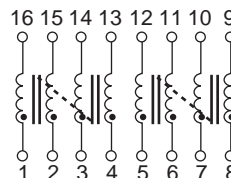

## 23Z106SM

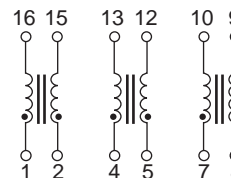

## 23Z109SM

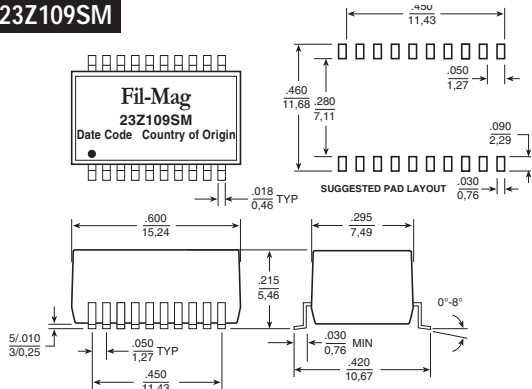

Dimensions: Inches  
mm

Unless otherwise specified,  
all tolerances are  $\pm .005$   
0,13

Weight . . . . . 1.3 grams  
Tape & Reel . . . . . 500/reel  
Tube . . . . . 38/tube

## 23Z109SM

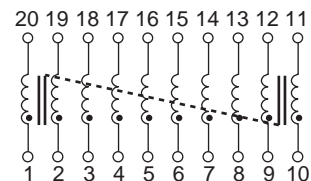

## 23Z4000SMD

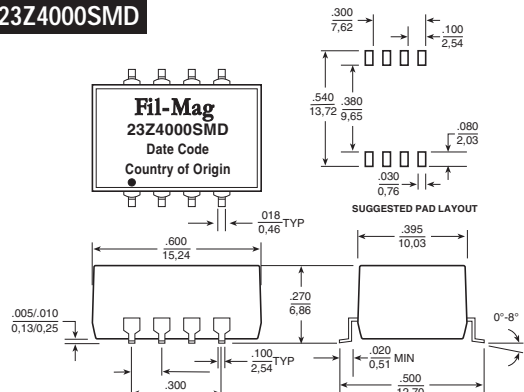

Dimensions: Inches  
mm

Unless otherwise specified,  
all tolerances are  $\pm .005$   
0,13

Weight . . . . . 2.1 grams  
Tape & Reel . . . . . 350/reel  
Tube . . . . . 38/tube

## 23Z4000SMD

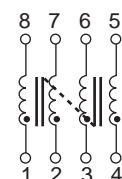

# SURFACE MOUNT COMMON MODE CHOKES

Suited for LAN and Telecom Applications



## Mechanical

## Schematic

### T8003

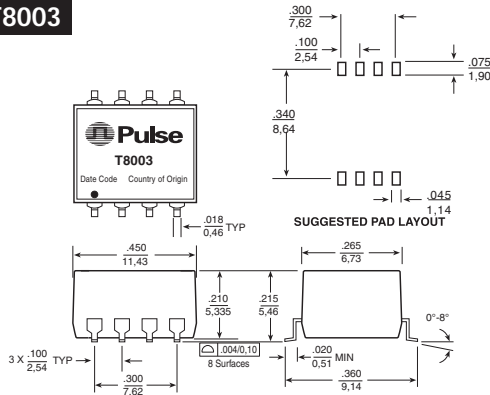

Dimensions: Inches  
mm

Unless otherwise specified,  
all tolerances are  $\pm .005$ -  
0,13

Weight . . . . . 0.84 grams  
Tape & Reel . . . . . 750/reel  
Tube . . . . . 100/tube

### T8003



### T8055



Dimensions: Inches  
mm

Unless otherwise specified,  
all tolerances are  $\pm .010$ -  
0,25

Weight . . . . . 0.2 grams  
Tape & Reel . . . . . 1750/reel  
Tube . . . . . 80/tube

### T8055



### B4003



Dimensions: Inches  
mm

Unless otherwise specified,  
all tolerances are  $\pm .010$ -  
0,25

Weight . . . . . 1.0 grams  
Tape & Reel . . . . . 425/reel  
Tube . . . . . 50/tube

### B4003

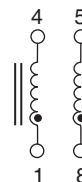

### T8008

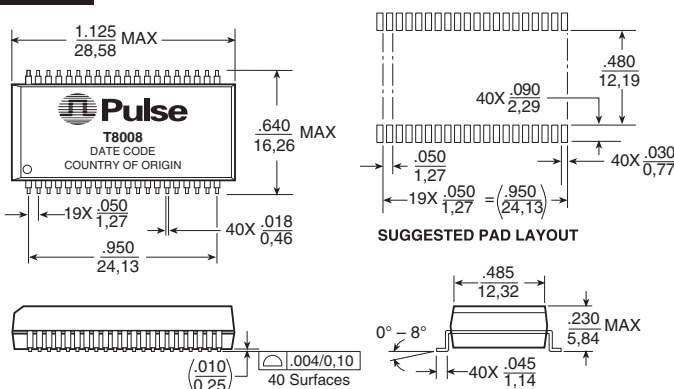

Dimensions: Inches  
mm

Unless otherwise specified,  
all tolerances are  $\pm .010$ -  
0,25

Weight . . . . . 4.0 grams  
Tape & Reel . . . . . 250/reel  
Tube . . . . . 15/tube

### T8008

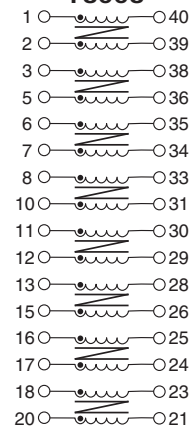



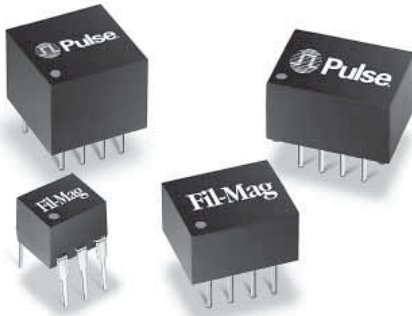

NOTE: The common mode test circuit for surface mount is the same as for through hole and is on the back page.

# THROUGH HOLE COMMON MODE CHOKES

Suited for LAN and Telecom Applications



-  Reduces radiated EMI emissions
-  Filters common mode noise for EMI reduction
-  Common mode attenuation from 100 kHz to 1 GHz
-  Tube packaging available for through hole parts

## Electrical Specifications @ 25°C

Part Number	No. of Lines	Primary Inductance OCL (μH MIN)	Common Mode Attenuation (dB TYP)								DCR (Ω MAX)	Page Number Mech & Schem	
			100 kHz	1 MHz	10 MHz	30 MHz	50 MHz	100 MHz	300 MHz	500 MHz			1 GHz
PE-65944	2	24	1	14	28	32	33	28	13	5	—	0.30	8
PE-67531	2	140	14	34	45	49	50	47	38	32	25	0.60	9
B2005	2	9000	47	47	41	30	22	33	21	15	15	1.0	10
PE-65554	4	24	—	21	32	38	39	34	24	13	—	0.30	8
PE-68002	4	68	7	24	37	41	42	40	31	27	—	0.35	9
23Z104	4	85	8	23	29	29	28	25	17	11	—	0.20	10
PE-67539	4	140	14	33	44	48	48	43	33	28	19	0.60	9
PE-65542	4	1000	28	41	42	32	22	—	—	—	—	0.70	8
PT5039	4	3600	42	43	42	32	27	17	15	9	13	0.50	8
J0010D11	4	—	9	13	32	35	35	29	13	24	19	0.50	10
PE-65950	4	4700±30%	40	51	37	28	23	20	—	—	—	1.00	8
PE-65541	4	6000	44	54	33	32	29	—	—	—	—	1.40	8
PE-68613	4	3290	40	51	37	28	23	20	—	—	—	1.00	10

## Mechanical

## Schematic

### PE-65541, PE-65542, PE-65950



Dimensions: Inches \_\_\_\_\_  
mm \_\_\_\_\_  
Unless otherwise specified,  
all tolerances are ± .010  
0,25

Weight . . . . . 0.38 grams  
Tube . . . . . 35/tube

**PE-65541**  
**PE-65542**  
**PE-65950**

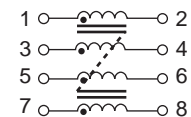

# THROUGH HOLE COMMON MODE CHOKES

Suited for LAN and Telecom Applications



Mechanical

Schematic

**PE-65554**



Dimensions:  $\frac{\text{Inches}}{\text{mm}}$   
Unless otherwise specified,  
all tolerances are  $\pm \frac{.010}{0,25}$

Weight . . . . . 2.5 grams  
Tube . . . . . 35/tube

**PE-65554**



**PT5039**



Dimensions:  $\frac{\text{Inches}}{\text{mm}}$   
Unless otherwise specified,  
all tolerances are  $\pm \frac{.010}{0,25}$

Weight . . . . . 2.5 grams  
Tube . . . . . 35/tube

**PT5039**



**PE-65944**

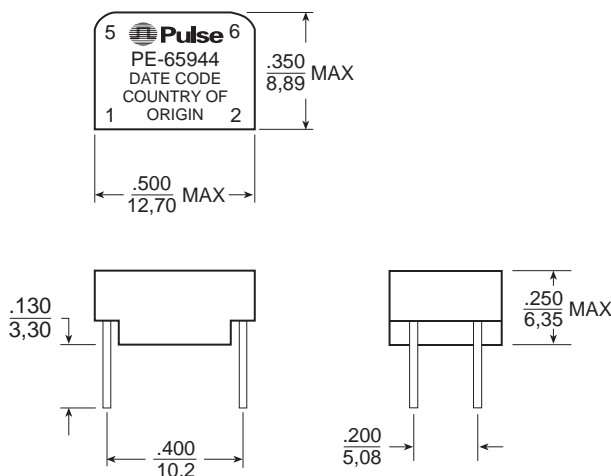

Dimensions:  $\frac{\text{Inches}}{\text{mm}}$   
Unless otherwise specified,  
all tolerances are  $\pm \frac{.010}{0,25}$

Weight . . . . . 1.07 grams  
Tube . . . . . 30/tube

**PE-65944**



# THROUGH HOLE COMMON MODE CHOKES

Suited for LAN and Telecom Applications



Mechanical

Schematic

## PE-67539

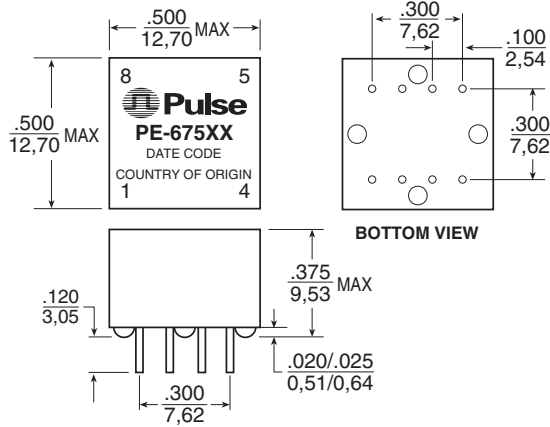

Dimensions:  $\frac{\text{Inches}}{\text{mm}}$   
Unless otherwise specified,  
all tolerances are  $\pm \frac{.010}{0,25}$

Weight . . . . . 2.4 grams  
Tube . . . . . 40/tube

## PE-67539

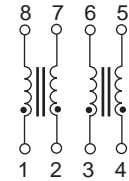

## PE-67531



Dimensions:  $\frac{\text{Inches}}{\text{mm}}$   
Unless otherwise specified,  
all tolerances are  $\pm \frac{.010}{0,25}$

Weight . . . . . 0.76 grams  
Tube . . . . . 40/tube

## PE-67531



## PE-68002

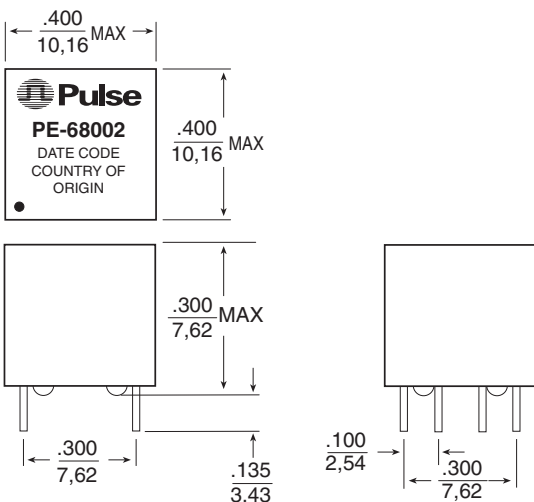

Dimensions:  $\frac{\text{Inches}}{\text{mm}}$   
Unless otherwise specified,  
all tolerances are  $\pm \frac{.010}{0,25}$

Weight . . . . . 1.4 grams  
Tube . . . . . 50/tube

## PE-68002

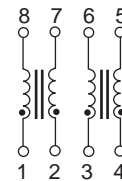

# THROUGH HOLE COMMON MODE CHOKES

Suited for LAN and Telecom Applications



## Mechanical

## Schematic

### B2005



Dimensions:  $\frac{\text{Inches}}{\text{mm}}$   
Unless otherwise specified,  
all tolerances are  $\pm \frac{.005}{0,13}$

Weight . . . . . 3.7 grams  
Tube . . . . . 40/tube

### B2005



### 23Z104

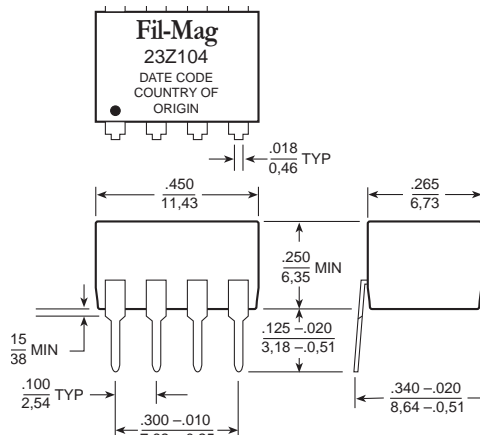

Dimensions:  $\frac{\text{Inches}}{\text{mm}}$   
Unless otherwise specified,  
all tolerances are  $\pm \frac{.005}{0,13}$

Weight . . . . . 1.0 grams  
Tube . . . . . 50/tube

### 23Z104

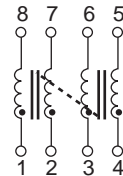

### PE-68613



Dimensions:  $\frac{\text{Inches}}{\text{mm}}$   
Unless otherwise specified,  
all tolerances are  $\pm \frac{.005}{0,127}$

Weight . . . . . 3.5 grams  
Tube . . . . . 40/tube

### PE-68613





## Looking for pricing, stock, or lifecycle information?

Click below to explore more details on WIN SOURCE:

 [View PE-68627T on WIN SOURCE](#)

 [Pulse Information](#)

## Optimize Your Supply Chain with WIN SOURCE Solutions

-  Global Sourcing Solution
-  Obsolete Management
-  Cost Control Management
-  Shortage Management
-  Alternative Solution
-  Excess Inventory Management