



**THE DATASHEET OF
PE-67540NLT**



Surface Mount Common Mode Chokes

Suited for LAN and Telecom Applications

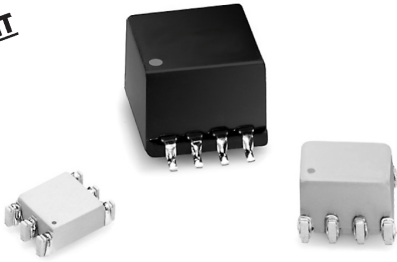

- Reduces radiated EMI emissions
- Filters common mode noise for EMI reduction
- Common mode attenuation from 100 kHz to 1 GHz
- RoHS peak reflow solder temperature rating 245°C

Electrical Specifications @ 25°C

Part Number	No. of Ports	Primary Inductance OCL (μH MIN)	Common Mode Attenuation (dB TYP)									DCR (Ω MAX)
			100 KHz	1 MHz	10 MHz	30 MHz	50 MHz	100 MHz	300 MHz	500 MHz	1 GHz	
PE-68624NL ^{2a}	1	47	11	27	40	44	42	36	26	17	-	0.40
PE-65855NL ^{2a}	1	4700	41	43	49	39	34	26	20	20	12	1.0
PE-65857NL ^{2a}	4	22.5	7	20	30	37	38	34	24	13	-	0.22
PE-68627NL ^{2a}	4	24	8	21	32	36	37	36	30	20	-	0.25
PE-65854NL ^{2a}	4	47	3	19	32	36	35	29	12	6	-	0.40
PE-67540NL ^{2a}	4	100	14	33	44	48	49	44	34	29	20	0.60
T8008NL ^{2a}	8	47	7	27	40	44	42	36	26	-	-	0.40

Notes:

- For Tape & Reel packaging, add suffix "T" to the end of the part number e.g. T8008NLT
- MSL = Moisture Sensitivity Level a=1 b=2 c=3 d=4

Mechanical

Schematic

PE-68624NL

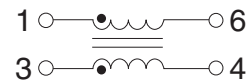
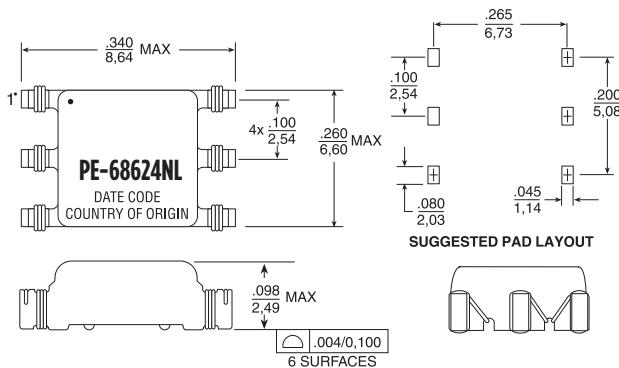

Weight0.17 grams
Tape & Reel1500/reel
Tube85/tray

Dimensions: $\frac{\text{Inches}}{\text{mm}}$

Unless otherwise specified, all tolerances are $\pm \frac{.010}{0.25}$

Surface Mount Common Mode Chokes

Suited for LAN and Telecom Applications

Mechanicals

Schematics

PE-65854NL

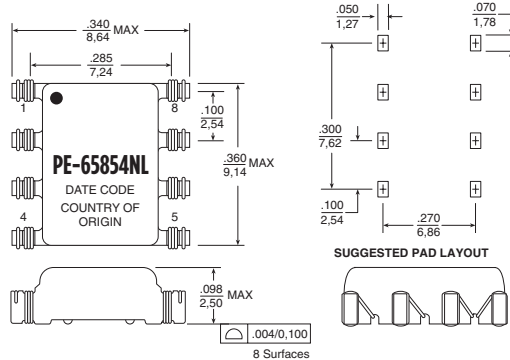

Weight0.3 grams
Tape & Reel1500/reel
Tube60/tray

Dimensions: $\frac{\text{Inches}}{\text{mm}}$

Unless otherwise specified,
all tolerances are $\pm \frac{.010}{0,25}$

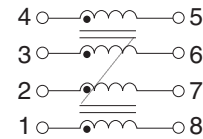

PE-65855NL

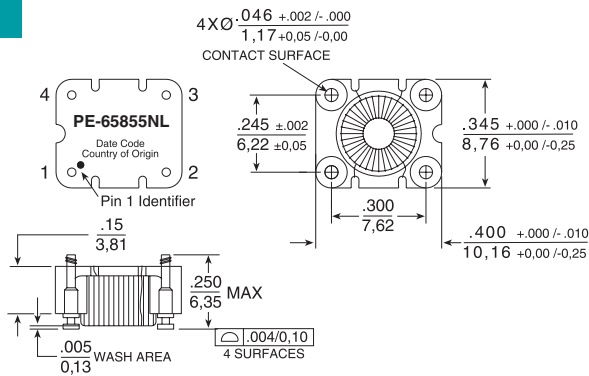

Weight0.69 grams
Tape & Reel800/reel
Tube40/tray

Dimensions: $\frac{\text{Inches}}{\text{mm}}$

Unless otherwise specified,
all tolerances are $\pm \frac{.010}{0,25}$



PE-65857NL, PE-67540NL

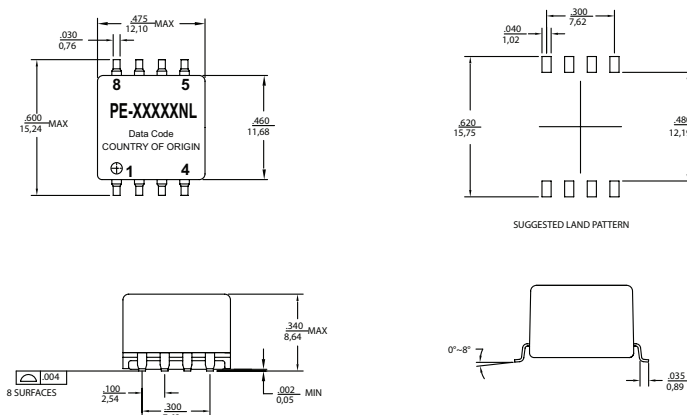

Weight2.0 grams
Tape & Reel250/reel
Tube40/tray

Dimensions: $\frac{\text{Inches}}{\text{mm}}$

Unless otherwise specified,
all tolerances are $\pm \frac{.010}{0,25}$

PE-65857NL PE-67540NL

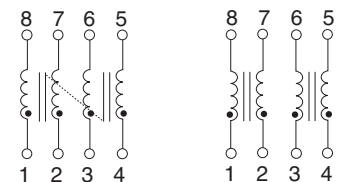

PE-68627NL

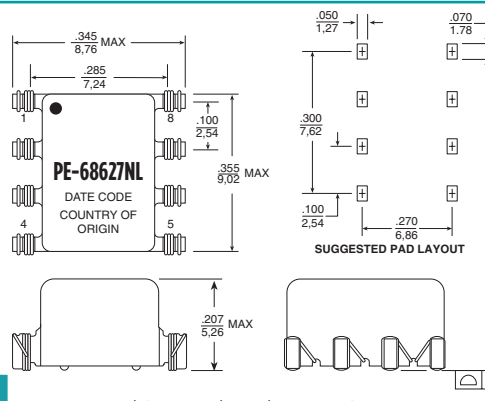

Weight0.3 grams
Tape & Reel1500/reel
Tube55/tray

Dimensions: $\frac{\text{Inches}}{\text{mm}}$

Unless otherwise specified,
all tolerances are $\pm \frac{.010}{0,25}$

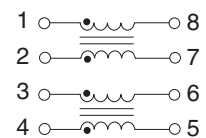

Surface Mount Common Mode Chokes

Suited for LAN and Telecom Applications

Mechanical

Schematic

T8008NL

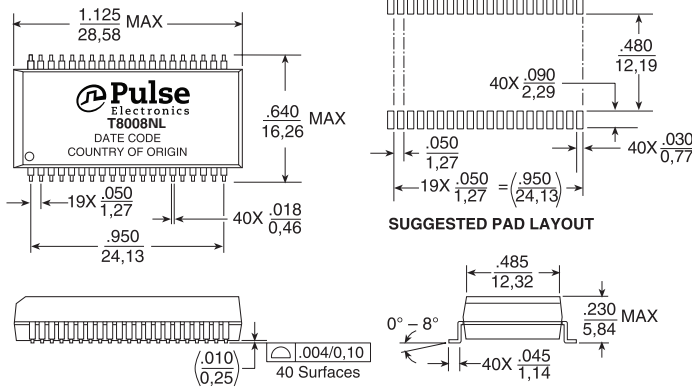

Weight4.0 grams
Tape & Reel250/reel
Tube15/tray

Dimensions: $\frac{\text{Inches}}{\text{mm}}$

Unless otherwise specified,
all tolerances are $\pm \frac{.010}{0,25}$

T8008NL

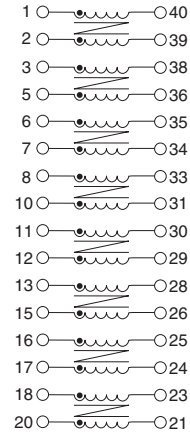

Common Mode Test Circuit for Surface Mount and Through Hole

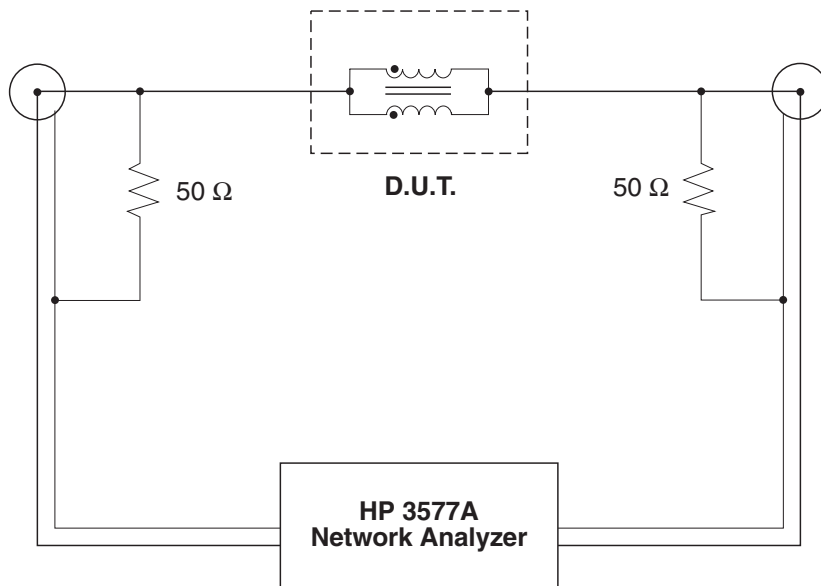

Test Notes:

1. Network analyzer calibrated to compensate for 50 Ω resistors.
2. All windings on a core are connected in parallel for the test.
3. For multi-core chokes, test data is for one core only. The windings on the other core(s) are left unconnected (i.e. open).

For More Information:

Americas - prodinfo@networkamericas@pulseelectronics.com | Europe - comms-Apps-Europe@pulseelectronics.com | Asia - prodinfo@networkapac@pulseelectronics.com

Performance warranty of products offered on this data sheet is limited to the parameters specified. Data is subject to change without notice. Other brand and product names mentioned herein may be trademarks or registered trademarks of their respective owners. © Copyright, 2019. Pulse Electronics, Inc. All rights reserved.

Looking for pricing, stock, or lifecycle information?

Click below to explore more details on WIN SOURCE:

 [View PE-67540NLT on WIN SOURCE](#)

 [Pulse Information](#)

Optimize Your Supply Chain with WIN SOURCE Solutions

-  Global Sourcing Solution
-  Obsolete Management
-  Cost Control Management
-  Shortage Management
-  Alternative Solution
-  Excess Inventory Management