







**THE DATASHEET OF
PE-65662**

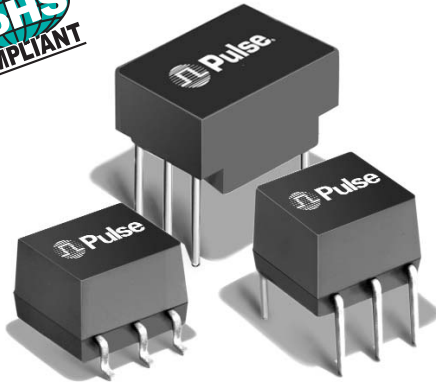

T3/DS3/E3/STS-1 TRANSFORMERS

Designed for T3, DS3, E3 and
STS-1 Interfaces



-  Return loss meets requirements of G.703
-  Fast rise time compatible with standards
-  Through hole and surface mount packages available
-  UL recognized

Electrical Specifications @ 25°C — Operating Temperature 0°C to 70°C

RoHS-5 Compliant Part No.	RoHS-6 Compliant Part No.	Turns Ratio (±2%)	OCL Primary (μH MIN)	OCL at -40°C (μH MIN)	LL (μH MAX)	C _{w/w} (pF MAX)	Bandwidth 75Ω System (MHz TYP)	Isolation Voltage (V _{rms} MIN)	Package/ Schematic	Primary Pins
PE-65661	PE-65661NL	1:2CT	35	20	.12	10	–	1500	TR-2/B SMT	2-6
PE-65662	PE-65662NL	1:1	45	30	.12	13	–	1500	TR-2/A SMT	2-6
PE-65663	PE-65663NL	1:1	40	30	.12	13	–	1500	QC-1/A THT	2-6
PE-65664	PE-65664NL	1:2CT	35	20	.12	10	–	1500	QC-1/B THT	2-6
PE-65779	PE-65779NL	1:4CT	150	–	.30	15	–	1500	QC-1/B THT	2-6
PE-65856	PE-65856NL	1:1.73CT	50	–	.10	12	.060-300	1500	LC-1/C THT	4-6
PE-65966	PE-65966NL	1:1	40	–	.10	10	.200-340	1500	LC-1/E THT	4-6
PE-65967	PE-65967NL	1:1	40	–	.10	10	.200-340	1500	LS-1/E SMT	4-6
PE-65968	PE-65968NL	1:2CT	19	–	.06	10	.250-500	1500	LS-1/C SMT	4-6
PE-65969	PE-65969NL	1:2CT	19	–	.06	10	.250-500	1500	LC-1/C THT	4-6
PE-68629	PE-68629NL	1:1	40	–	.10	5	–	3000 ⁴	HC-1/A THT	1-5
PE-68630	PE-68630NL	1:2CT	19	–	.06	10	–	3000 ⁴	HC-1/D THT	1-5

Electrical Specifications @ 25°C

Part Number	Turns Ratio (Pri:Sec ±5%)	OCL @ 25°C (mH MIN)	C _{w/w} (pF MAX)	L _L (μH MAX)	DCR Pri (Ω MAX)	DCR Sec (Ω MAX)	Isolation Voltage (V _{rms} MIN)	Package/ Schematic	Primary Pins
PE-64934	1:1	1.20	25	0.50	0.70	0.70	1500	HC-1/1S	1-2

Packaging Information

Package	Type	Part Weight	Parts/Tube	Parts/Reel	Reel Diameter	Tape Width	Pitch
LS-1	SMT	0.6 grams	70	600	13 inches	24 mm	16 mm
TR-2	SMT	0.6 grams	65	500	13 inches	24 mm	16 mm
LC-1	THT	0.6 grams	65	–	–	–	–
HC-1	THT	1.2 grams	60	–	–	–	–
QC-1	THT	0.8 grams	60	–	–	–	–

T3/DS3/E3/STS-1 TRANSFORMERS

Designed for T3, DS3, E3 and
STS-1 Interfaces



Mechanical

Schematics

TR-2

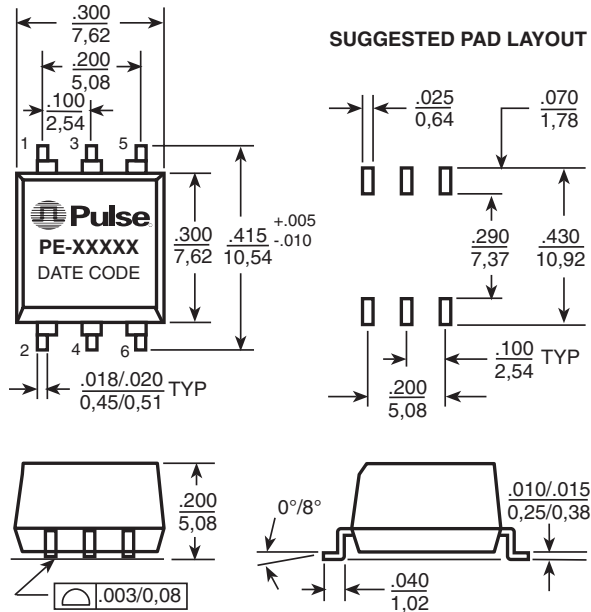

Dimensions: $\frac{\text{Inches}}{\text{mm}}$

Unless otherwise specified all tolerances are $\pm \frac{.010}{0,25}$

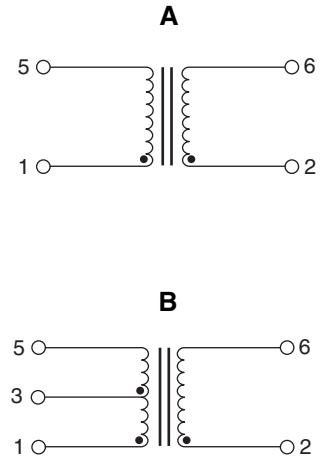

QC-1

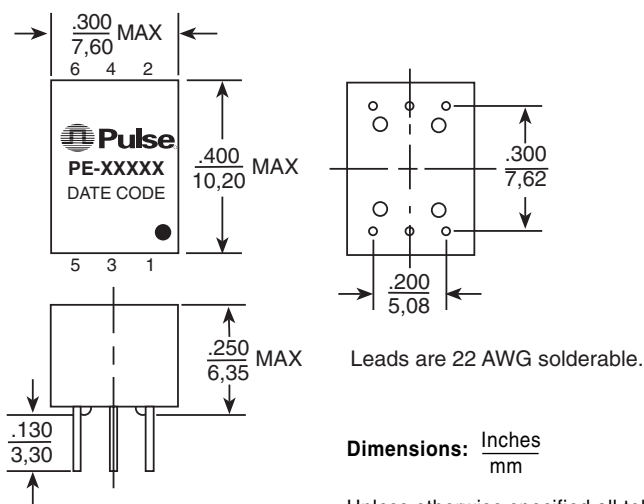

Dimensions: $\frac{\text{Inches}}{\text{mm}}$

Unless otherwise specified all tolerances are $\pm \frac{.010}{0,25}$

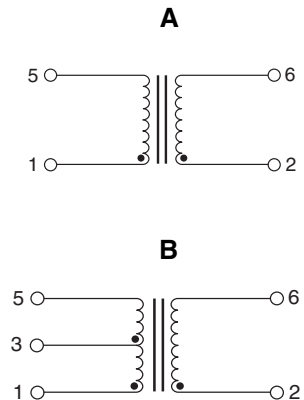

T3/DS3/E3/STS-1 TRANSFORMERS

Designed for T3, DS3, E3 and
STS-1 Interfaces



Mechanical

Schematics

LC-1

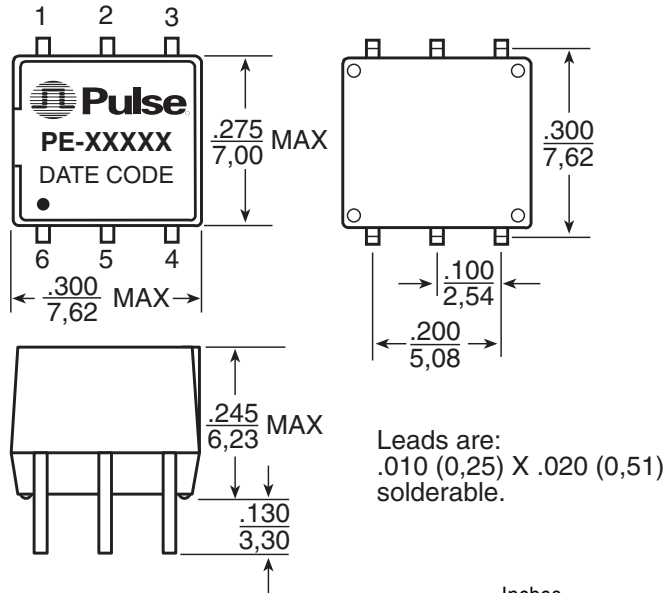

Leads are:
.010 (0,25) X .020 (0,51)
solderable.

Dimensions: $\frac{\text{Inches}}{\text{mm}}$

Unless otherwise specified all tolerances are $\pm \frac{.010}{0,25}$

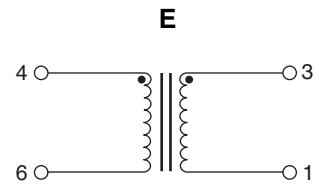
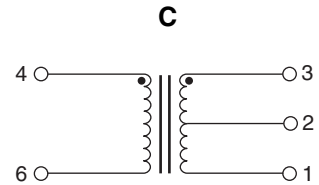

HC-1

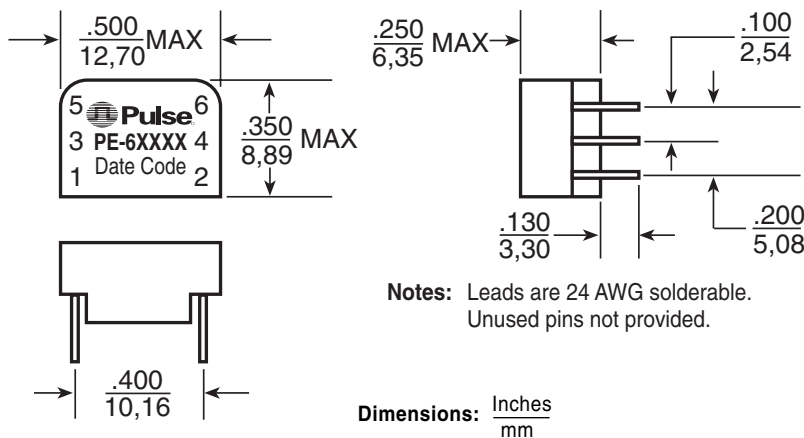

Notes: Leads are 24 AWG solderable.
Unused pins not provided.

Dimensions: $\frac{\text{Inches}}{\text{mm}}$

Unless otherwise specified all tolerances are $\pm \frac{.010}{0,25}$

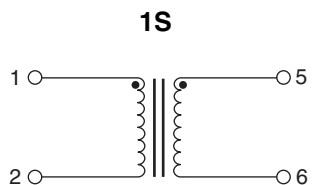
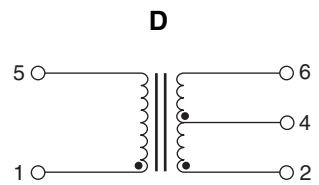
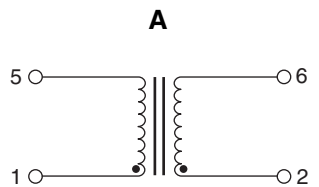

T3/DS3/E3/STS-1 TRANSFORMERS

Designed for T3, DS3, E3 and STS-1 Interfaces



Mechanical

Schematics

LS-1

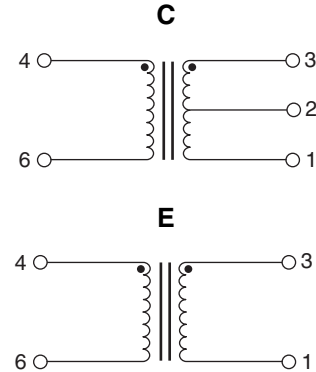
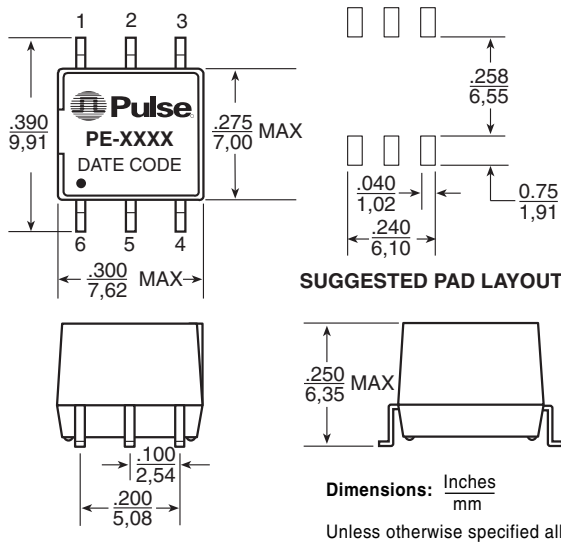

Transformer Selection Guide

Chip Manufacturer	Surface Mount		Through Hole (1500Vrms)		Through Hole (3000Vrms)	
	Transmit	Receive	Transmit	Receive	Transmit	Receive
Lucent T7296	PE-65967	-	PE-65966	-	PE-68629	-
Exar XR-T7296	PE-65967	-	PE-65966	-	PE-68629	-
Silicon Systems						
SSI 78P236, DS3	PE-65968	PE-65967	PE-65969	PE-65966	PE-68630	PE-68629
SSI 78P7200, DS3	PE-65968	PE-65967	PE-65969	PE-65966	PE-68630	PE-68629
SSI 78P7200, E3	PE-65968	PE-65968	PE-65969	PE-65969	PE-68630	PE-68630
SSI 78P2361, STS-1	PE-65968	PE-65967	PE-65969	PE-65966	PE-68630	PE-68629
SSI 78P2362, E3	PE-65968	PE-65967	PE-65969	PE-65966	PE-68630	PE-68629
Transwitch						
MRT TXC-02050 ⁵ , E3	PE-65968	PE-65967	PE-65969	PE-65966	PE-68630	PE-68629
ART 02020 DS3, STS-1	PE-65967	PE-65967	PE-65966	PE-65966	PE-68629	PE-68629

Application Notes

1. The transformers have been developed for use as transmit and receive transformers in T3 or DS3 links, using bit rates of 44.736Mbps and B3ZS coding on coaxial cable. The characteristics allow compliance with the pulse templates of CCITT G.703 as well as ATT T.A.34. The transformers are also suitable for the E3 interface at 34.368 Mbps with HDB3 coding or STS-1 applications, at 51.84 Mbps according to Bellcore TA-NWT-000253. The LC-1 and QC-1 packages are pin compatible with T1-1 and T4-1 6-pin DIP packages.

- Bandwidth specifications are typical in a 75Ω system. Return loss meets the requirements of G.703. Materials used in the products are UL94-V0 recognized. Products meet the requirements of IEC 695-2-2 (Needle Flame Test).
- The surface mount LS-1 and TR-2 packages are available with optional tape and reel packaging. To order, add a "T" suffix to the part number (i.e.: PE-65967NLT).
- The Transwitch MRT TXC-02050 chip is also designed to operate in 6.312 and 8.448 Mbps interfaces. A 1:1 transformer (PE-64934) is recommended.

For More Information:

Pulse Worldwide Headquarters
12220 World Trade Dr.
San Diego, CA 92128
U.S.A.
www.pulseeng.com

Pulse Europe
Einsteinstrasse 1
D-71083 Herrenberg
Germany

Pulse China Headquarters
B402, Shenzhen
Tech-Innovation International
Tenth Kejianan Rd.
High-Tech Industrial Park
Nanshan District, Shenzhen
China

Pulse North China
Room 1503
XinYin Building
No. 888 YiShan Rd.
Shanghai 200233
China

Pulse South Asia
150 Kampong Ampat
#07-01/02
KA Centre
Singapore 368324

Pulse North Asia
No. 26
Kao Ching Rd.
Yang Mei Chen
Tao Yuan Hsien
Taiwan, R. O. C.

Tel: 858 674 8100
Fax: 858 674 8262

Tel: 49 7032 7806 0
Fax: 49 7032 7806 12

Tel: 86 755 33966678
Fax: 86 755 33966700

Tel: 86 21 54643211/2
Fax: 86 21 54643210

Tel: 65 6287 8998
Fax: 65 6280 0080

Tel: 886 3 4641811
Fax: 886 3 4641911

Performance warranty of products offered on this data sheet is limited to the parameters specified. Data is subject to change without notice. Other brand and product names mentioned herein may be trademarks or registered trademarks of their respective owners. © Copyright, 2007. Pulse Engineering, Inc. All rights reserved.

Looking for pricing, stock, or lifecycle information?

Click below to explore more details on WIN SOURCE:

 [View PE-65662 on WIN SOURCE](#)

 [Pulse Information](#)

Optimize Your Supply Chain with WIN SOURCE Solutions

-  Global Sourcing Solution
-  Obsolete Management
-  Cost Control Management
-  Shortage Management
-  Alternative Solution
-  Excess Inventory Management