









**THE DATASHEET OF
PE-64995**

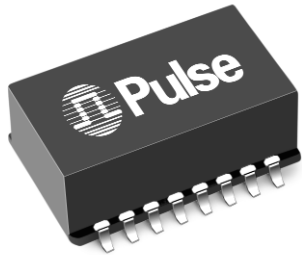

ISDN S-INTERFACE TRANSFORMERS

Surface Mount, Dual, 2000Vrms



-  Meets pulse waveform template of CCITT I.430 when recommended transformer and chip pair are used
-  Excellent longitudinal balance
-  2KVrms isolation voltage
-  Available in tape and reel, tray or tube packaging
-  Recognized by UL

Electrical Specifications @ 25°C — Operating Temperature 0°C to 70°C

Part Number	Ratio ^A (±2%)		OCL Pri ^B (mH MIN)	L _L Sec (μH MAX)		Cw/w (pF MAX)	CD Pri (pF MAX)		DCR Pri (Ω ±25%)		DCR Sec (Ω ±25%)		Δ Ibc ^C (mA MAX)	Package/Schematic
	A	B	A & B	A	B	A & B	A	B	A	B	A	B		
PE-65792	1:1	1:2	22	5	15	100	42	80	2.4	2.3	2.4	4.0	1	SC-1
PE-65793	1:1	1:1	22	5	5	100	42	42	2.4	2.4	2.4	2.4	1	SC-1
PE-65795	1:2	1:2	22	15	15	100	80	80	2.5	2.5	4.3	4.3	1	SC-1
PE-65798	1:2.5	1:2.5	22	8-40	8-40	100	110	110	2.5	2.5	5.8	5.8	1	SC-1
PE-65799	1:2	1:2	22	11	11	100	180	180	2.4	2.4	4.4	4.4	1	SC-1

NOTE: For low profile version of products listed above, refer to data sheet T613.

(See Pages 4 and 5 for Table Notes)

Mechanical

Schematic

SC-1

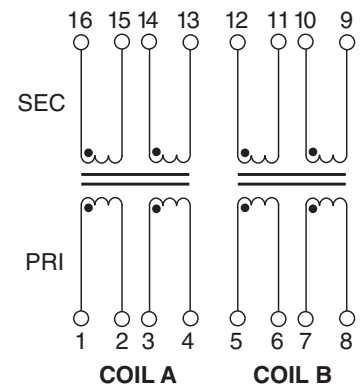
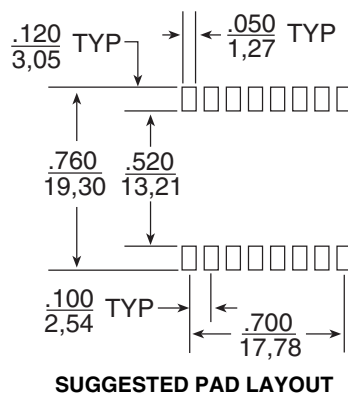
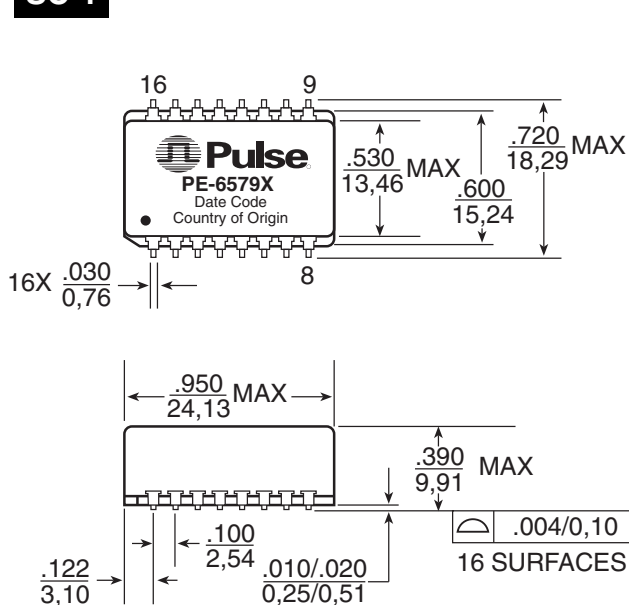

Dimensions: $\frac{\text{Inches}}{\text{mm}}$

Unless otherwise specified all tolerances are $\pm \frac{.010}{0,25}$

See page 4 for packaging information.

ISDN S-INTERFACE TRANSFORMERS

Through Hole, Single, 2000Vrms

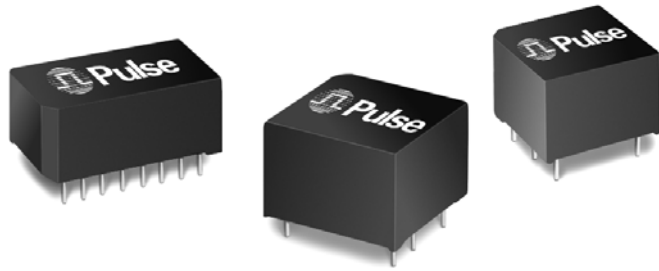

- Meets the pulse waveform template of CCITT I.430 when recommended transformer and chip pair are used
- Excellent longitudinal balance
- 2KVrms or higher voltage isolation
- Recognized by UL

Electrical Specifications @ 25°C — Operating Temperature 0°C to 70°C

2KV ISOLATION, THROUGH HOLE, SINGLE TRANSFORMERS

Part Number	Ratio ^A (±2%)	OCL Pri (mH MIN)	L _L Sec (μH MAX)	C _{w/w} (pF MAX)	CD Pri (pF MAX)	DCR Pri (Ω ±25%)	DCR Sec (Ω ±25%)	Isolation (Vrms MIN)	Δ Ibc ^C (mA MAX)	Package/ Schematic
PE-64993	1CT:1CT	22	5	100	42	2.4	2.4	2000	1	IS-1
PE-64994	1CT:1.8CS	22	15	100	160	2.5	4.2	2000	1	IS-2
PE-64995	1CT:2CT	22	15	100	80	2.5	4.3	2000	1	IS-1
PE-64996	1CT:2.5CS	22	30	100	150	2.5	5.8	2000	1	IS-2
PE-64998	1CS:2.5CS	22	15-40	100	110	2.5	5.8	2000	1	IS-3
PE-64999	1CT:2CT	22	11	100	180	2.4	4.4	2000	1	IS-1

(See Pages 4 and 5 for Table Notes)

Mechanicals

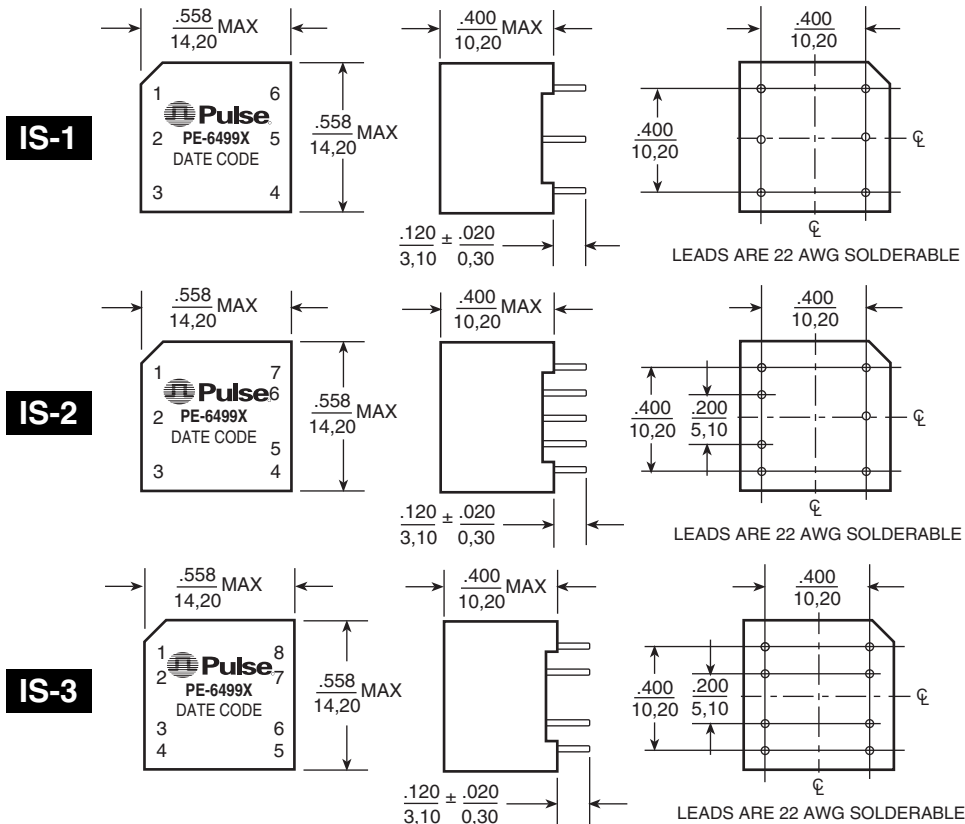

Schematics

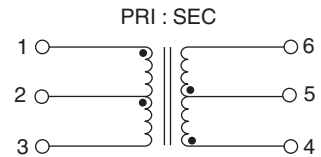

See page 4 for packaging information.

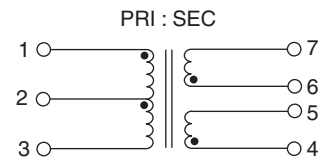

See page 4 for packaging information.

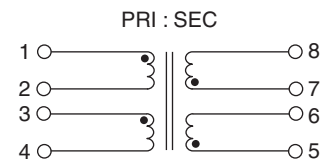

See page 4 for packaging information.

Dimensions: $\frac{\text{Inches}}{\text{mm}}$ Unless otherwise specified, all tolerances are $\pm \frac{.010}{0,25}$

ISDN S-INTERFACE TRANSFORMERS

Dual and Single Through Hole



Electrical Specifications @ 25°C — Operating Temperature 0°C to 70°C

Part Number	COIL A				COIL B				Package/Schematic
	Ratio ^A	Equivalent Single	Primary Pins	Secondary Pins	Ratio ^A	Equivalent Single	Primary Pins	Secondary Pins	
PE-65492	1:1	PE-64993	1-4	16-13	1:2	PE-64995	5-8	12-9	ID-1
PE-65493	1:1	PE-64993	1-4	16-13	1:1	PE-64993	5-8	12-9	ID-1
PE-65495	1:2	PE-64995	1-4	16-13	1:2	PE-64995	5-8	12-9	ID-1
PE-65498	1:2.5	PE-64998	1-4	16-13	1:2.5	PE-64998	5-8	12-9	ID-1
PE-65499	1:2	PE-64999	1-4	16-13	1:2	PE-64999	5-8	12-9	ID-1

NOTE: Refer to the equivalent single part number for electrical specifications.

(See Pages 4 and 5 for Table Notes)

Mechanical

Schematic

ID-1

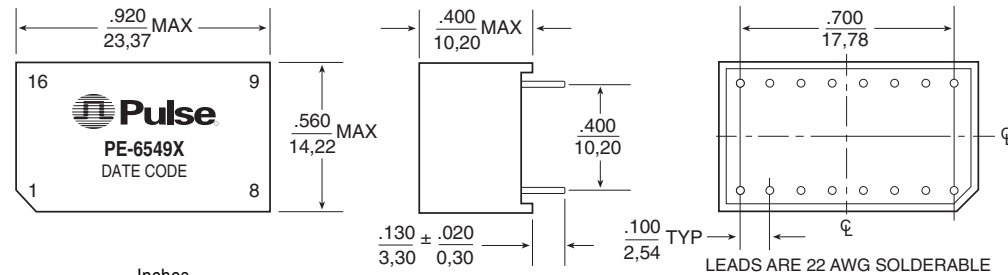

See page 4 for packaging information.

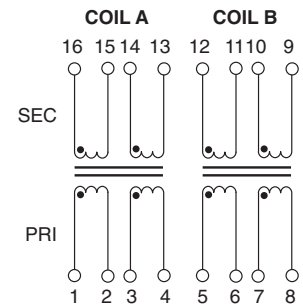

REINFORCED INSULATION!

Electrical Specifications @ 25°C — Operating Temperature 0°C to 70°C

3kV REINFORCED INSULATION, THROUGH HOLE, SINGLE TRANSFORMERS

Pulse Part Number	Ratio ^A ± 2% (Pri:Sec)	OCL Pri (mH MIN)	L _L Sec (μH MAX)	C _{w/w} (pF MAX)	C _D (pF MAX)	DCR (Ω ± 25%)		Unbalanced I _{DC} ^C (mA MAX)	Package/Schematic
						Primary	Secondary		
PE-68992	1CS:2CT	22	15	60	80	3.0	5.5	5	WD-1/B
PE-68993	1CS:1	22	5	40	40	2.8	2.7	5	WD-1/A
PE-68995	1CS:2	22	15	60	80	3.0	5.5	5	WD-1/A
PE-68998	1CS:2.5	22	8-40	60	110	3.0	7.0	5	WD-1/A
PE-68999	1CS:2	22	11	50	110	2.8	5.5	5	WD-1/A

(See Pages 4 and 5 for Table Notes)

Mechanical

Schematic

WD-1

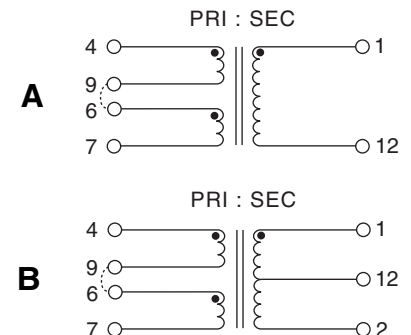
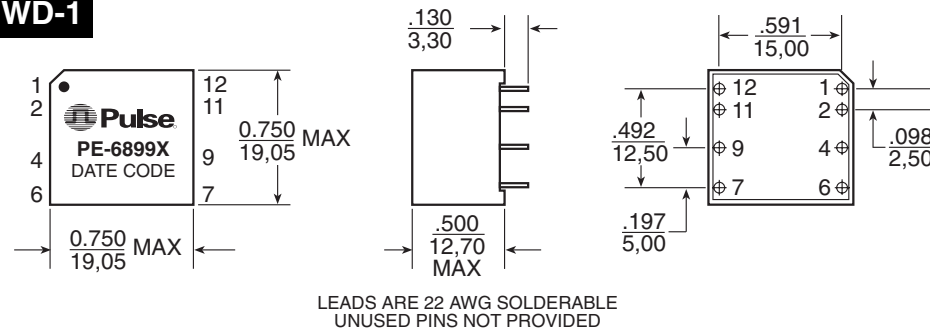

See page 4 for packaging information.

Dimensions: Inches / mm Unless otherwise specified, all tolerances are $\pm \frac{.010}{0,25}$

ISDN S-INTERFACE TRANSFORMERS



Transformer Selection and Packaging

IC Manufacturer	IC Part Number	Dual Surface Mount	Single Through Hole, 2 KVrms		Dual Through Hole	Single Through Hole, 3 KVrms	
		Trans & Rec	Transmit	Receive	Trans & Rec	Transmit	Receive
AMD	Am 79C30A/79C32A	PE-65799	PE-64999	PE-64999	PE-65499	PE-68999	PE-68999
AT&T/Lucent	T7250/7256/7259 T7903	PE-65798	PE-64998	PE-64998	PE-65498	PE-68998	PE-68998
		PE-65795	PE-64995	PE-64995	PE-65495	PE-68995	PE-68995
Mietec	MTC-2072	PE-65795	PE-64995	PE-64995	PE-65495	PE-68995	PE-68995
Mitel	MT8930	PE-65795	PE-64995	PE-64995	PE-65495	PE-68995	PE-68995
Motorola	MC145474/145475 MC145574	PE-65793	PE-64993	PE-64993	PE-65493	PE-68993	PE-68993
		PE-65798	PE-64998	PE-64998	PE-65498	PE-68998	PE-68998
National ^D	TP3420/3421	PE-65795	PE-64995	PE-64995	PE-65495	PE-68995	PE-68992
SGS Thomson	ST5420, ST5421	PE-65795	PE-64995	PE-64995	PE-65495	PE-68995	PE-68995
Siemens	PEB 2080/2081/2085 PSB 2186 PEB 2084/2086	PE-65795	PE-64995	PE-64995	PE-65495	PE-68995	PE-68995
Yamaha	7405B	PE-65795	PE-64995	PE-64995	PE-65495	PE-68995	PE-68995

NOTES

- A. In this catalog, turns ratio is expressed as “primary:secondary”. The term “CT” designates a center tapped winding. The term “CS” designates a split center tap winding. A center tapped winding can be created by connecting two ends of a split center winding together on the printed circuit board. In ISDN-S applications, the primary winding is the line side transformer winding.
- B. The minimum primary inductance and the maximum distributed capacitance satisfy the transmitter output and receiver input impedance requirements of CCITT I.430 for both the TE and the NT. The maximum distributed capacitance allows sufficient margin for the capacitance of the IC and a protection diode network. It is consistent with the overall maximum value specified and the permitted length of the basic access TE cord.
- C. The maximum specified unbalanced DC current capability is based on 20 mH minimum primary OCL.
- D. National recommends a 1:2 receive transformer, but used as a 1:1 ratio by connecting only half the secondary winding. See National’s application note.
- E. PE-65950, PE-68613 and PE-65853 are recommended for use with Siemens PEB 2080/2085 and help in meeting the required longitudinal balance.
- F. Standard packaging for all chokes and transformers listed in this catalog is anti-static tubes. Optional anti-static tray packaging can be ordered for the surface mount SC-1 and LA-1 packages by adding an “R” suffix to the part number, (ie: PE-65795R). Optional tape and reel packaging can be ordered for all surface mount packages by adding a “T” suffix to the part number, (ie: PE-65795T).
- G. For PE-65854, OCL at -40°C is 27 µH minimum. For maximum performance use windings (1-8) and (2-7) as a pair and windings (3-6) and (4-5) as a pair.
- H. For transformers and choke modules, refer to data sheet **T632**.

Packaging Information

Package ^F	Type	Part Weight	Parts/Tube	Parts/Tray	Parts/Reel	Reel Diameter	Tape Width	Pitch
LA-1	SMT	2.0 grams	30	60	250	13 inches	24 mm	24 mm
PA-2	SMT	4.0 grams	35	–	150	13 inches	32 mm	24 mm
SC-1	SMT	7.0 grams	20	50	150	13 inches	44 mm	24 mm
SH-4	SMT	0.3 grams	25	–	1500	13 inches	24 mm	12 mm
ID-1	THT	7.0 grams	20	–	–	–	–	–
IN-1	THT	2.5 grams	35	–	–	–	–	–
IS	THT	4.0 grams	35	–	–	–	–	–
VC-1	THT	3.5 grams	40	–	–	–	–	–
WD-1	THT	9.0 grams	25	–	–	–	–	–

(See Pages 4 and 5 for Table Notes)

ISDN S-INTERFACE TRANSFORMERS

Application Notes

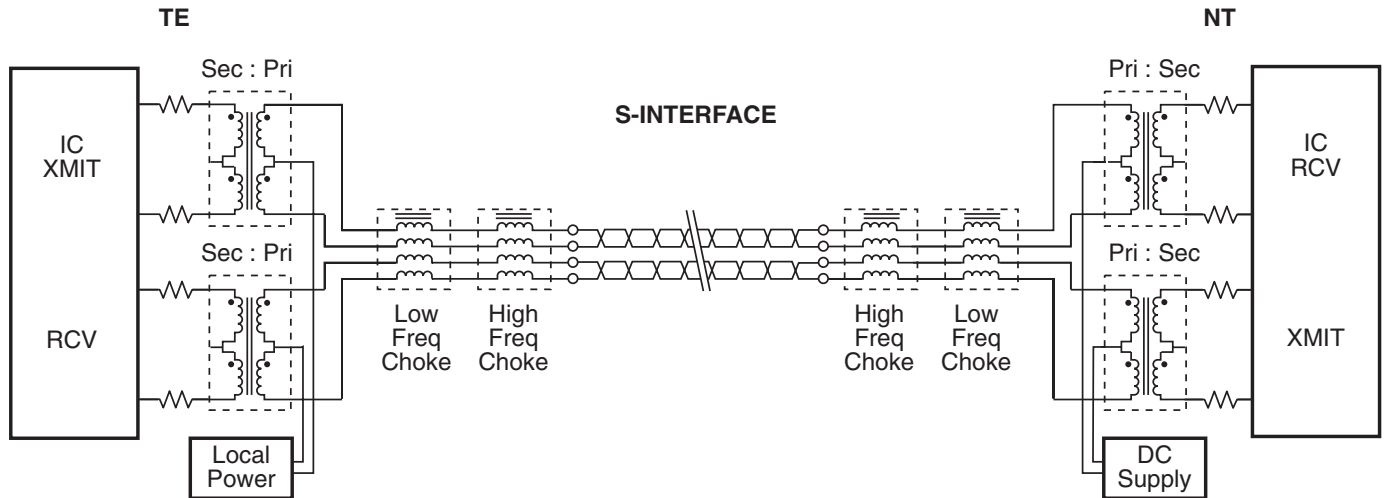

Figure 1. Typical ISDN S-Interface Application Circuit

1. General Information – The S-interface is the standardized four-wire digital telephone access point defined by the CCITT I-series recommendations for the Integrated Services Digital Network. This “basic rate access” accommodates two 64Kbps “B-channels” for information, one 16Kbps “D-channel” intended for signaling and control, and 48 Kbps for framing and other purposes, giving a total rate of 192Kbps. The CCITT physical layer recommends that the user network interface be transformer coupled. A typical application circuit is presented in **Figure 1**.

The transformer provides isolation for the line card or the terminal from the line. It is also a way to provide phantom power feeding to the terminal over the S-loop. Each end requires a transmit and a receive transformer. Chokes are used in some applications to reduce common mode noise (see note 5).

The transformers described in this data sheet are matched to the transceivers offered by the major IC manufacturers listed. The use of a transformer-chip pair assures that all requirements of CCITT I.430 are met with respect to pulse waveform templates, impedance and longitudinal balance. In addition, the transformers provide the isolation voltages required by the regulatory agencies and are capable of passing surge voltage tests.

2. Longitudinal Balance for Transformers – The longitudinal conversion loss specification in I.430 includes a test setup that is intended for system evaluation, whether TE or NT. Such a test is performed with DC current present. The transformer plays an essential role in achieving the required balance. However, all other elements in the circuit should be also designed to provide the highest possible symmetry. These elements include the protection circuitry, series resistors, chip transmitter output and receiver input, as well as the cables used and the TE cord where applicable. A high level of transformer balance compensates for some circuit AC-unbalance, and assures compliance of the system with I.430 on longitudinal conversion loss (LCL) and signal balance. This is accomplished by a well AC-balanced winding configuration whereby the capacitive coupling between primary and secondary windings is evenly distributed. Also, both halves of the lineside winding are well balanced. The transformers meet the following LCL specifications:

- 10kHz to 300kHz: 60dB minimum
- 300kHz to 1MHz: Minimum value decreasing 20dB/decade.

(continued on next page)

ISDN S-INTERFACE TRANSFORMERS

Application Notes

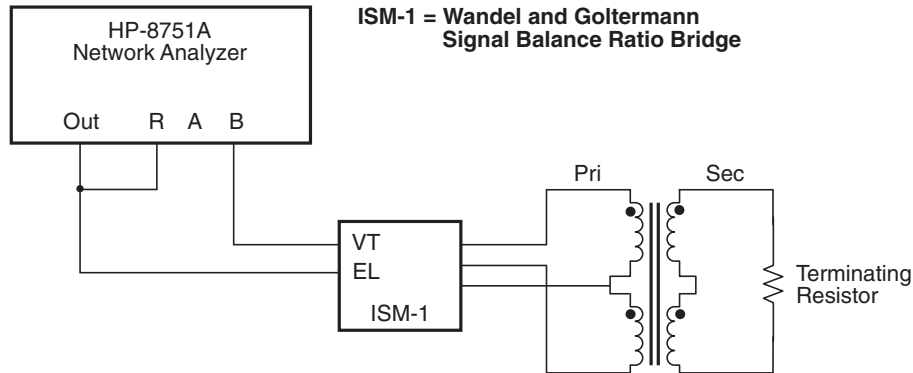

Figure 2. Longitudinal Balance Test Circuit

(continued from previous page)

A recommended test setup is shown in **Figure 2**. A high inductance “low frequency” common mode choke, such as PE-65950 or PE-65853, is recommended to improve balance, or to correct inherent unbalances of some circuits.

4. Impedance Requirements – The requirements for minimum impedance in the inactive and powered-down states are expressed by impedance templates for both transmitter and receiver in NT and TE. At the low frequency end of 1MHz, it is reasonable to assume that the impedance seen from the line is entirely capacitive. The maximum capacitance budget, derived from the templates, is somewhat different for the NT and the TE. Contributors to the total capacitance are: the chip output, the protection circuit, the transformer, common mode choke and any other element that may be present. In the TE case, there is also the maximum allowable TE cord impedance. Here the maximum budget is 800pF. As a rule, the capacitances should be kept as low as possible in the interface circuit design. With the specified transformer capacitances, it is possible to remain within budget and have a reasonable margin for measurement errors.

5. Common Mode Chokes – The “high frequency” 4-wire common mode chokes shown on pages 7 and 8 provide an effective means of compliance with national and international regulations on EMI. They are designed to be used in conjunction with either Pulse’s ISDN S-Interface or T1/CEPT transformers as shown in **Figure 1**. A high inductance “low frequency” common mode choke is recommended to improve balance, or to correct inherent unbalances of some ISDN S-Interface circuits.

6. Surge Voltage Capability for Transformers and Chokes

- Longitudinal Voltage Peak: 2,400V 10/700µsec
- Metallic Voltage Peak: 800V 10/560µsec

7. Behavior Under Fault Conditions – Telephony voltages may accidentally appear on the ISDN S-Interface line to the transformer. The transformer will withstand a DC current of 0.5 Amps for 15 minutes without permanent damage. Such current may be caused by the telephone central battery. The transformer will also survive ringing voltages. These are nominally 120V or 200V maximum at 20 to 60Hz, limited by 1500Ω resistive or 400 to 600Ω inductive limiting. These may cause peak currents.

8. Flammability – Materials used in the products are recognized UL94-VO. Products meet the requirements of IEC 695-2-2 (Needle Flame Test).

ISDN S-INTERFACE TRANSFORMERS

Common Mode Chokes for Telecom Applications

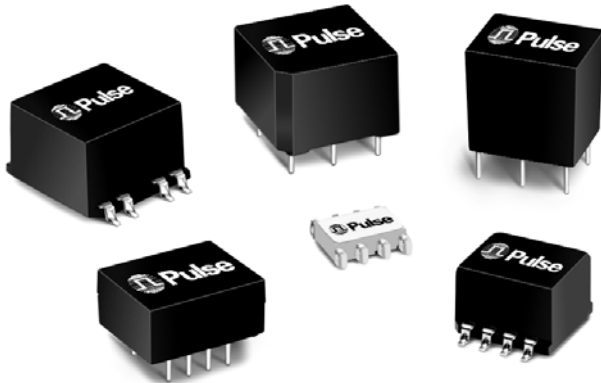

- Designed for 4-wire links, ISDN-S/T and T1/E1/CEPT
- High frequency chokes for EMI reduction
- Low frequency chokes improve longitudinal balance in ISDN-S/T links
- Surface mount and through hole models available

Electrical Specifications @ 25°C — Operating Temperature 0°C to 70°C

Part Number	OCL Pri	L _L Sec (μH MAX)	C _{w/w} (pF MAX)	DCR (Ω MAX)	Isolation (Vrms MIN)	Package/ Schematic
LOW FREQUENCY						
PE-65541	6.0 mH MIN	35	25	1.40	1,500	IS-4/1C (Through Hole)
PE-65542	1.0 mH MIN	10	10	0.70	1,500	IS-4/1C (Through Hole)
PE-65853 ^E	4.7 mH ±30%	1	60	1.20	500	PA-2/5C (Surface Mount)
PE-65950 ^E	4.7 mH ±30%	1	50	1.00	500	IS-4/1C (Through Hole)
PE-68613 ^E	4.7 mH ±30%	1	60	1.00	500	VC-1/5C (Through Hole)
HIGH FREQUENCY						
PE-65554	24.0 μH MIN	.20	15	0.30	500	IN-1/C (Through Hole)
PE-65555	8.0 μH MIN	.20	10	0.25	500	IN-1/C (Through Hole)
PE-65854 ^F	47.0 μH MIN	.18	20	0.40	500	SH-4/C (Surface Mount)
PE-65857	22.5 μH MIN	.23	17	0.30	500	LA-1/C (Surface Mount)

NOTE: For additional Common Mode Chokes, refer to data sheet G002.

Typical common mode attenuation for low frequency common mode chokes based on a 100 Ω system.

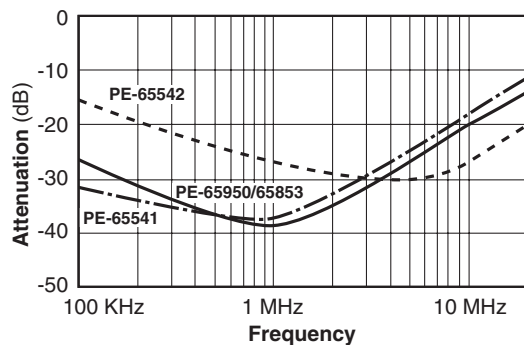

Typical impedance for low frequency common mode chokes based on a 100 Ω system.

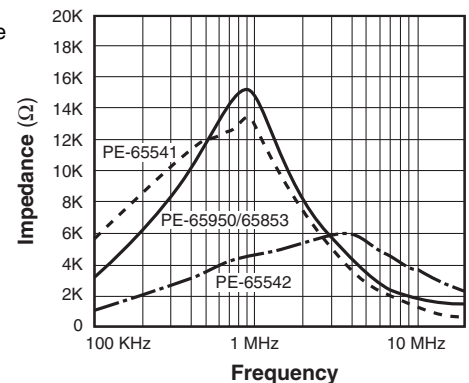

Typical common mode attenuation for high frequency common mode chokes based on a 100 Ω system.

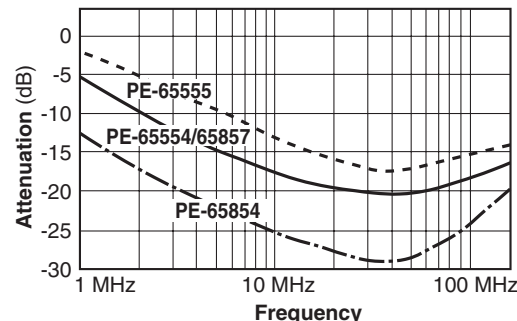

Typical impedance for high frequency common mode chokes based on a 100 Ω system.

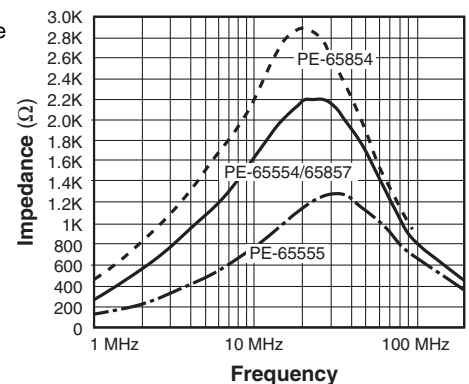

ISDN S-INTERFACE TRANSFORMERS

Common Mode Chokes for Telecom Applications



Mechanicals

VC-1

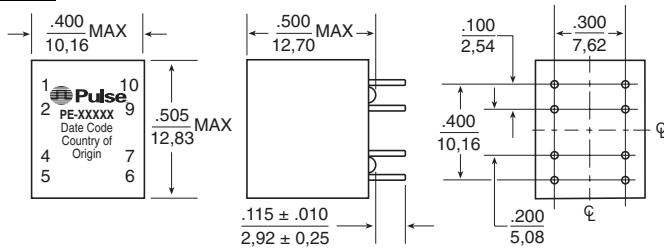

See page 4 for packaging information.

IN-1

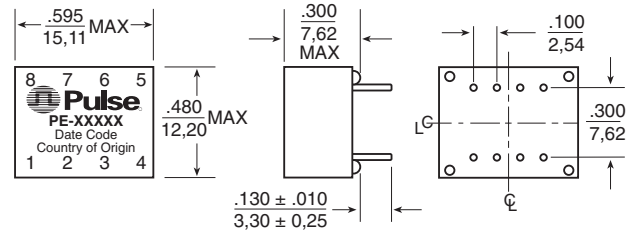

See page 4 for packaging information.

SH-4

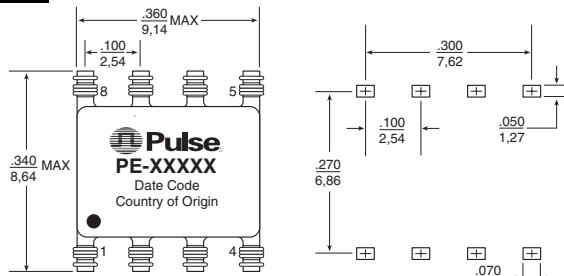

SUGGESTED PAD LAYOUT

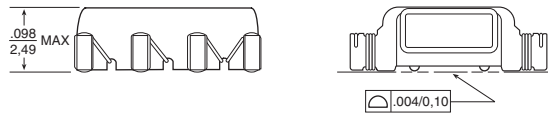

See page 4 for packaging information.

IS-4

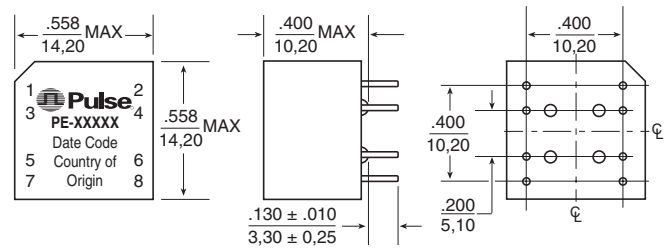

See page 4 for packaging information.

PA-2

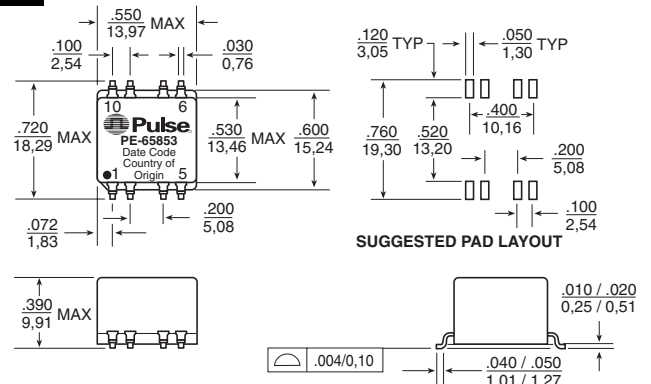

SUGGESTED PAD LAYOUT

See page 4 for packaging information.

LA-1

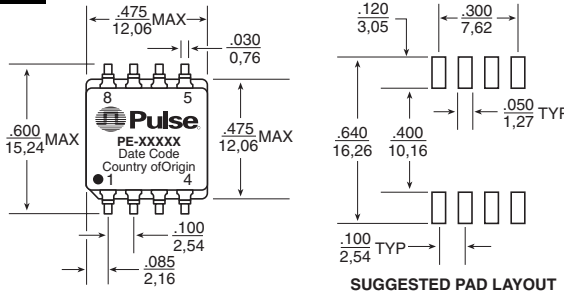

SUGGESTED PAD LAYOUT

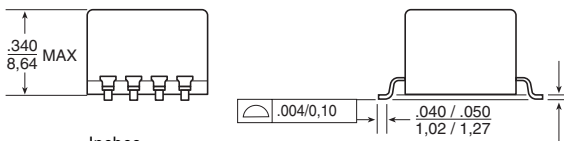

Dimensions: $\frac{\text{Inches}}{\text{mm}}$

Unless otherwise specified all tolerances are $\pm .010$
 $0,25$

See page 4 for packaging information.

For More Information:

Pulse Worldwide Headquarters

12220 World Trade Drive
San Diego, CA 92128
U.S.A.

www.pulseeng.com
TEL: 858 674 8100
FAX: 858 674 8262

Pulse Northern Europe

3 Huxley Road
Surrey Research Park
Guildford, Surrey GU2 5RE
United Kingdom

TEL: 44 1483 401700
FAX: 44 1483 401701

Pulse Southern Europe

Zone Industrielle
F-39270
Orgelet
France

TEL: 33 3 84 35 04 04
FAX: 33 3 84 25 46 41

Pulse China Headquarters

No. 1
Industrial District
Changan, Dongguan
China

TEL: 86 769 5538070
FAX: 86 769 5538870

Pulse North China

Room 1002
No. 819
Nanjing West Rd
Shanghai
China

TEL: 86 21 32181071
FAX: 86 21 32181396

Pulse South Asia

150 Kampong Ampat
#07-01/02
KA Centre
Singapore 368324

TEL: 65 6287 8998
FAX: 65 6280 0080

Pulse North Asia

3F-4, No. 81, Sec. 1
Hsin Tai Wu Road
Hsi-Chih
Taipei Hsien
Taiwan

TEL: 886 2 26980228
FAX: 886 2 26980948

Schematics

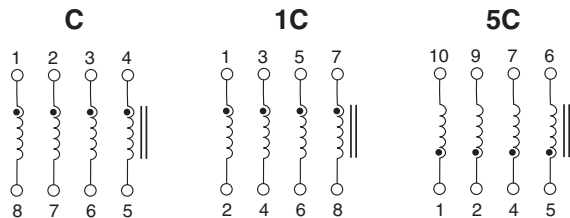

Performance warranty of products offered on this data sheet is limited to the parameters specified. Data is subject to change without notice. Other brand and product names mentioned herein may be trademarks or registered trademarks of their respective owners.

© Copyright, 2006. Pulse Engineering, Inc. All rights reserved.

www.pulseeng.com

T604.D (1/06)

Looking for pricing, stock, or lifecycle information?

Click below to explore more details on WIN SOURCE:

 [View PE-64995 on WIN SOURCE](#)

 [Pulse Information](#)

Optimize Your Supply Chain with WIN SOURCE Solutions

-  Global Sourcing Solution
-  Obsolete Management
-  Cost Control Management
-  Shortage Management
-  Alternative Solution
-  Excess Inventory Management