

DATA SHEET

PCF1252-X family Threshold detector and reset generator

Product specification
Supersedes data of 1996 Jan 23
File under Integrated Circuits, IC11

1998 Apr 16

Threshold detector and reset generator

PCF1252-X family

FEATURES

- Very low current consumption, typically 10 μ A
- 10 factory programmed threshold voltages available covering trip voltages from 4.75 to 2.55 V
- ± 50 mV trip point accuracy over full temperature range
- Variable RESET delay
- RESET pulse polarity selection
- Defined outputs at 0.6 V (typ.)
- Comparator for second level detection (e.g. overvoltage detection)
- Advance warning of power fail
- Operating temperature range -40 to $+85$ $^{\circ}$ C.

GENERAL DESCRIPTION

The PCF1252-Xs are low-power CMOS voltage threshold detectors designed especially for supervision of microcontroller/microprocessor systems for detection of power-on/off conditions and generation of a system reset pulse. The PCF1252-X also provides a $\overline{\text{POWF}}$ (power fail) output which is activated at a precise factory-programmed trip point. A system RESET output has a built-in delay with duration determined by an external capacitor (C_{CT}).

A second comparator (comparator 2) has been included to enable the possibility of a second monitoring point in the system.

ORDERING INFORMATION

TYPE NUMBER	PACKAGE		
	NAME	DESCRIPTION	VERSION
PCF1252-XP ⁽¹⁾	DIP8	plastic dual in-line package; 8 leads (300 mil)	SOT97-1
PCF1252-XT ⁽¹⁾	SO8	plastic small outline package; 8 leads; body width 3.9 mm	SOT96-1

Note

1. X = 0 to 9; depending on threshold voltage.

BLOCK DIAGRAM

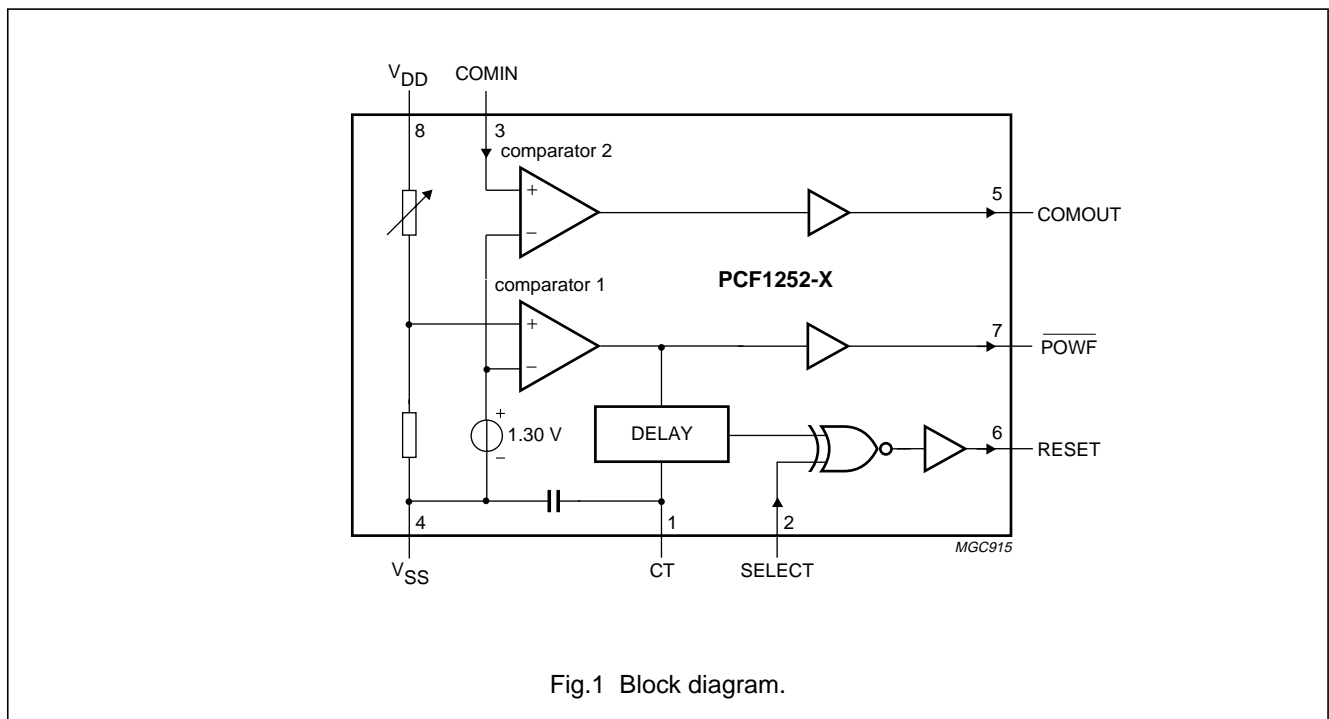

Fig.1 Block diagram.

Threshold detector and reset generator

PCF1252-X family

PINNING

SYMBOL	PIN	DESCRIPTION
CT	1	connection for the external capacitor
SELECT	2	select polarity or external reset input
COMIN	3	comparator input
V _{SS}	4	ground (0 V)
COMOUT	5	comparator output
RESET	6	reset output
$\overline{\text{POWF}}$	7	power failure signal output
V _{DD}	8	supply voltage

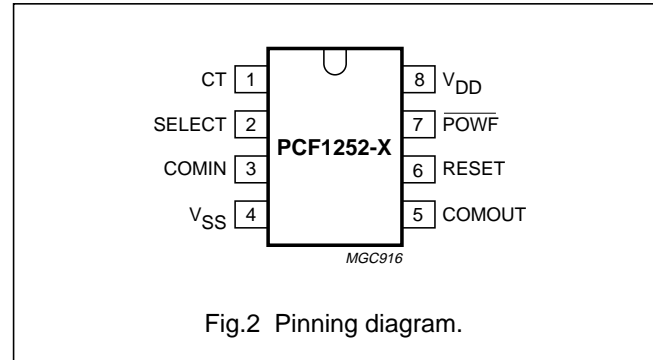

FUNCTIONAL DESCRIPTION (see Fig.1)

The PCF1252-X contains:

- A precise factory-programmed voltage reference
- Two comparators
- A delay circuit.

The PCF1252-X family is comprised of 10 versions with different factory-programmed voltage trip-points (V_{TRIP}), see Chapter "Characteristics".

Supply

The supply voltage (V_{DD}) is internally divided before being compared, via comparator 1, with the internal reference voltage.

 $\overline{\text{POWF}}$ (see Fig.3)

The $\overline{\text{POWF}}$ output is:

- LOW, if V_{DD} is below V_{TRIP}
- HIGH, if V_{DD} is above V_{TRIP} .

Power-on reset (SELECT = LOW)

As V_{DD} rises past V_{TRIP} , a positive reset pulse is generated at RESET. The duration of the reset pulse (t_{R}) is determined by the value of the external capacitor (C_{CT} ; maximum 1 μF , see Fig.8) connected to CT. With no external capacitor connected, C_{CT} assumes a minimum value of 100 pF. If SELECT is HIGH, the reset pulse is inverted.

Power failure

During a power-off condition ($V_{\text{DD}} < V_{\text{TRIP}}$), $\overline{\text{POWF}}$ goes LOW. After a time delay (t_{S}), also determined by C_{CT} , RESET goes HIGH. Any POWF assertion ($V_{\text{DD}} < V_{\text{TRIP}}$) will result in a subsequent RESET pulse.

Voltage trip-point

By selecting the voltage trip-point slightly higher than the minimum operating voltage of the microcontroller/microprocessor, there is sufficient time for data storage before the power actually fails.

In order to prevent oscillations around the voltage trip-point, a small hysteresis has been included, resulting in a power-on switching point that is higher than the voltage trip-point (minimum of 15 mV). The voltage trip-point refers to the value at which power-off is signalled.

COMIN

Input to the second comparator (comparator 2). When used in conjunction with an external voltage divider, this allows a second point in the system to be monitored. This input has no built-in hysteresis. When not in use connect to V_{DD} . COMOUT will be LOW or HIGH depending on the voltage at COMIN:

- COMOUT = HIGH, if voltage at COMIN is above the switch point V_{SP} (typically 1.30 V).
- COMOUT = LOW, if voltage at COMIN is below the switch point V_{SP} (typically 1.30 V).

Threshold detector and reset generator

PCF1252-X family

LIMITING VALUES

In accordance with the Absolute Maximum Rating System (IEC 134).

SYMBOL	PARAMETER	CONDITIONS	MIN.	MAX.	UNIT
V_{DD}	supply voltage		-0.5	+7.0	V
V_I	input voltage		-0.5	$V_{DD} + 0.5$	V
I_I	DC clamp-diode current	all pins: $V_I < -0.5$ V or $V_I > V_{DD} + 0.5$ V	-	20	mA
I_O	output current		-	20	mA
P_{tot}	total power dissipation		-	150	mW
T_{stg}	storage temperature		-65	+100	°C
T_{amb}	operating ambient temperature		-40	+85	°C

HANDLING

Inputs and outputs are protected against electrostatic discharge in normal handling. However, to be totally safe, it is desirable to take normal handling precautions appropriate to handling MOS devices (see "Handling MOS Devices").

CHARACTERISTICS

$V_{DD} = 2.4$ to 6.0 V; $V_{SS} = 0$ V; $T_{amb} = -40$ to $+85$ °C; (see Fig.3); unless otherwise specified.

SYMBOL	PARAMETER	CONDITIONS	MIN.	TYP.	MAX.	UNIT
V_{DD}	supply voltage		2.4	-	6.0	V
V_{TRIP}	Voltage trip-point: PCF1252-0 PCF1252-1 PCF1252-2 PCF1252-3 PCF1252-4 PCF1252-5 PCF1252-6 PCF1252-7 PCF1252-8 PCF1252-9	$T_{amb} = 25$ °C; note 1	4.70 4.50 4.20 4.00 3.70 3.50 3.20 3.00 2.70 2.50	4.75 4.55 4.25 4.05 3.75 3.55 3.25 3.05 2.75 2.55	4.80 4.60 4.30 4.10 3.80 3.60 3.30 3.10 2.80 2.60	V V V V V V V V V V
I_{DD}	supply current	$T_{amb} = 25$ °C; $V_{DD} = V_{TRIP} + 0.5$ V; $COMIN = V_{DD}$; see Figs. 4 and 5	-	10	15	μA
ΔV_{TRIP}	voltage trip-point temperature coefficient	note 2	-	$\pm 100 \times 10^{-6}$	$\pm 400 \times 10^{-6}$	mV/K
V_{hys}	voltage trip-point hysteresis		15	30	50	mV

Threshold detector and reset generator

PCF1252-X family

SYMBOL	PARAMETER	CONDITIONS	MIN.	TYP.	MAX.	UNIT
COMIN						
V_{SP}	COMIN switch point	$T_{amb} = 25\text{ }^{\circ}\text{C}$; note 1	1.28	1.30	1.32	V
ΔV_{SP}	COMIN switch point temperature coefficient	note 2	–	± 0.1	± 0.5	mV/K
SELECT						
V_{IL}	LOW level input voltage		–	–	$0.3V_{DD}$	V
V_{IH}	HIGH level input voltage		$0.7V_{DD}$	–	–	V
SELECT and COMIN						
I_{LI}	LOW level leakage input current		–	–	–1.0	μA
I_{LI}	HIGH level leakage input current		–	–	1.0	μA
POWF, RESET and COMOUT						
I_O	output sink current	$V_O = 0.4\text{ V}$; $V_{DD} = 2.4\text{ V}$; see Fig.6	1	3	–	mA
I_O	output source current	$V_O = 2.0\text{ V}$; $V_{DD} = 2.4\text{ V}$; see Fig.7	–0.75	–2	–	mA
t_R	reset time	$C_{CT} = 1\text{ nF}$; note 3	400	1000	2000	μs
t_S	save time	$C_{CT} = 1\text{ nF}$; note 3	40	100	200	μs
t_R/t_S	reset to save time ratio		–	10	–	
C_{int}	CT internal capacitance		–	100	–	pF

Notes

1. Long time stability of COMIN switch point V_{SP} and voltage trip point V_{TRIP} : within 10 years of continuous operation at $V_{DD(max)}$ and an average operating temperature of $55\text{ }^{\circ}\text{C}$ the drift of V_{SP} will not exceed $\pm 10\text{ mV}$. The maximum drift for V_{TRIP} will not exceed $(\pm V_{TRIP(typ)}/V_{SP(typ)}) 10\text{ mV}$.
2. Values given per degree Kelvin; tested on a sample basis.
3. Conformance to these specifications is only guaranteed if the slew rate of V_{DD} is less than 25 V/ms .

Threshold detector and reset generator

PCF1252-X family

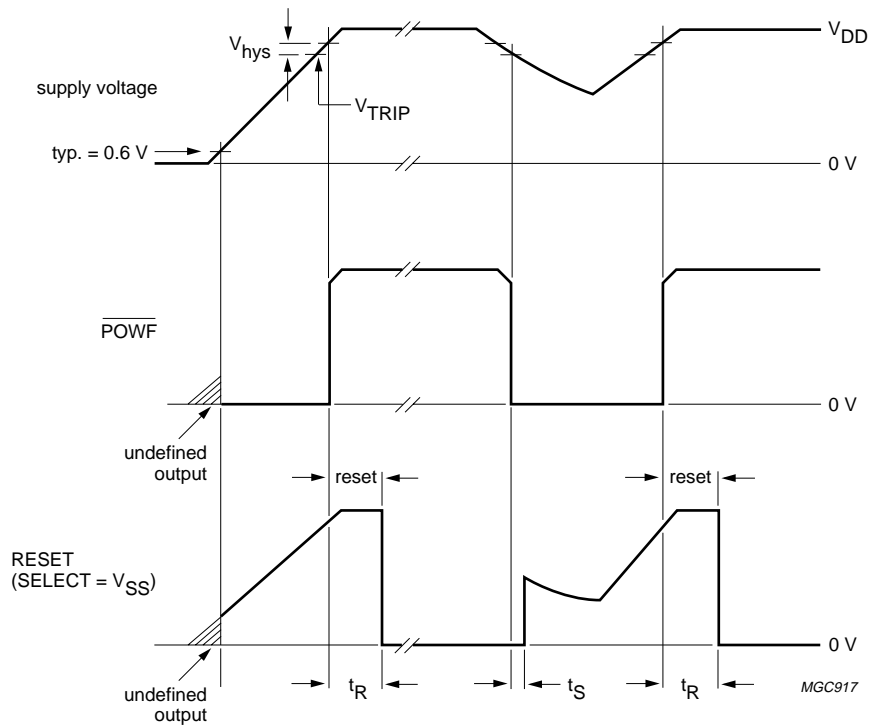

t_R = reset time (duration of reset pulse).

t_S = save time (time between assertion of \overline{POWF} and assertion of the reset output). This time can be used for storing of critical data and orderly system shut-down.

V_{hys} = hysteresis voltage (prevents oscillation around V_{TRIP}).

Fig.3 Timing diagram.

Threshold detector and reset generator

PCF1252-X family

Typical performance characteristics

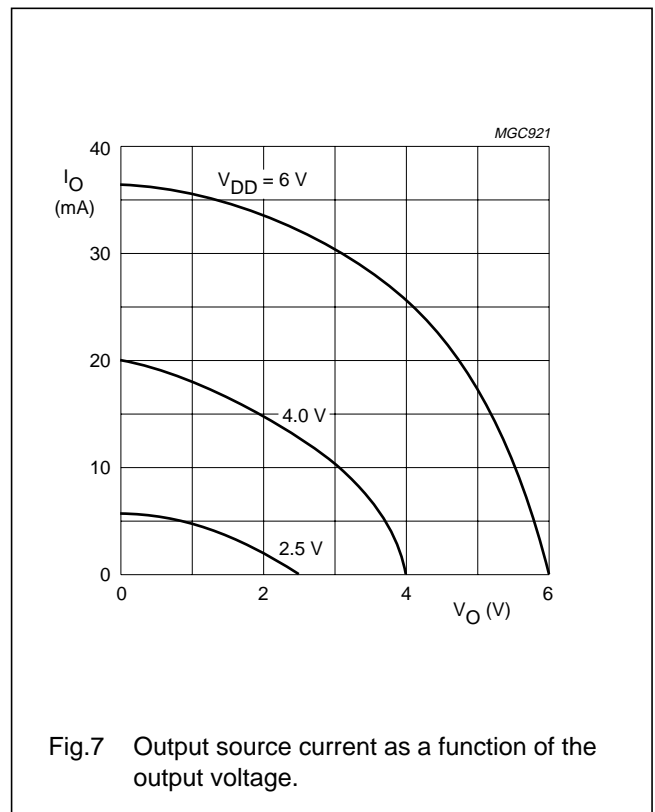
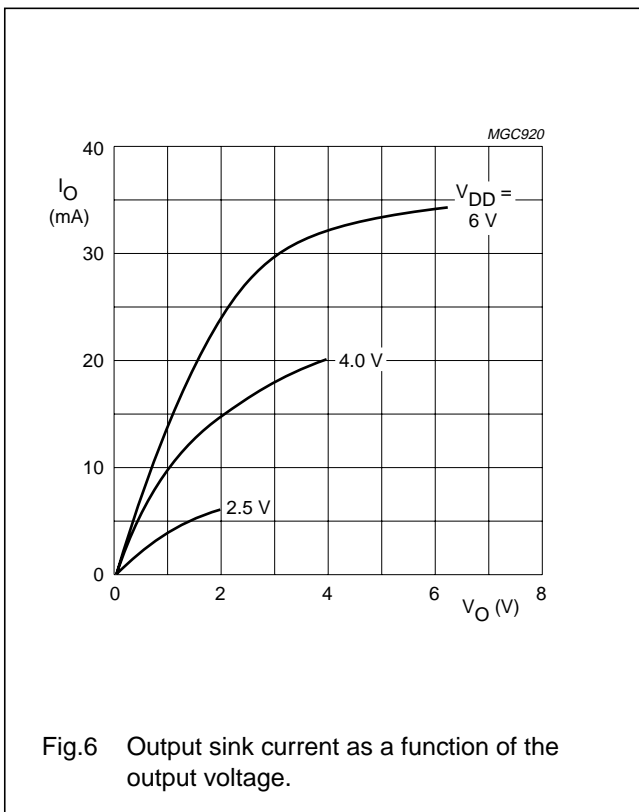
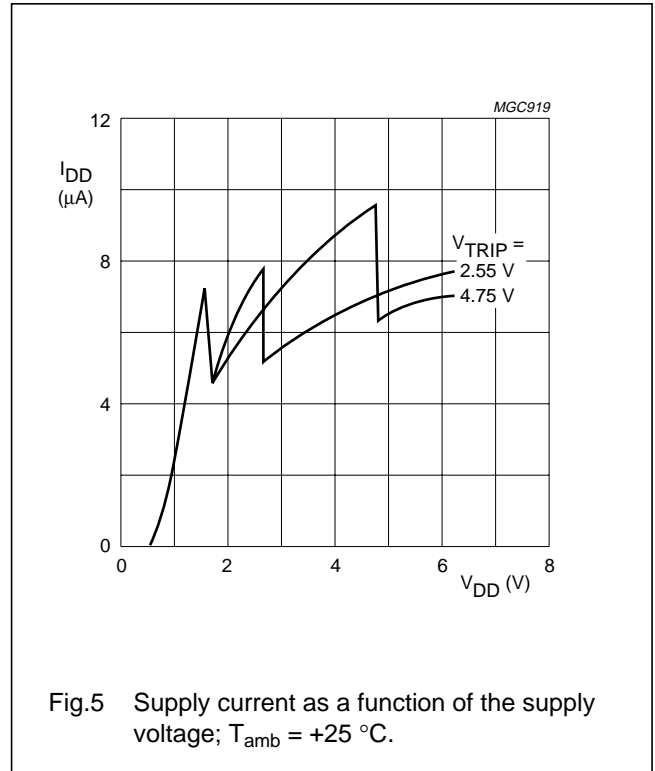
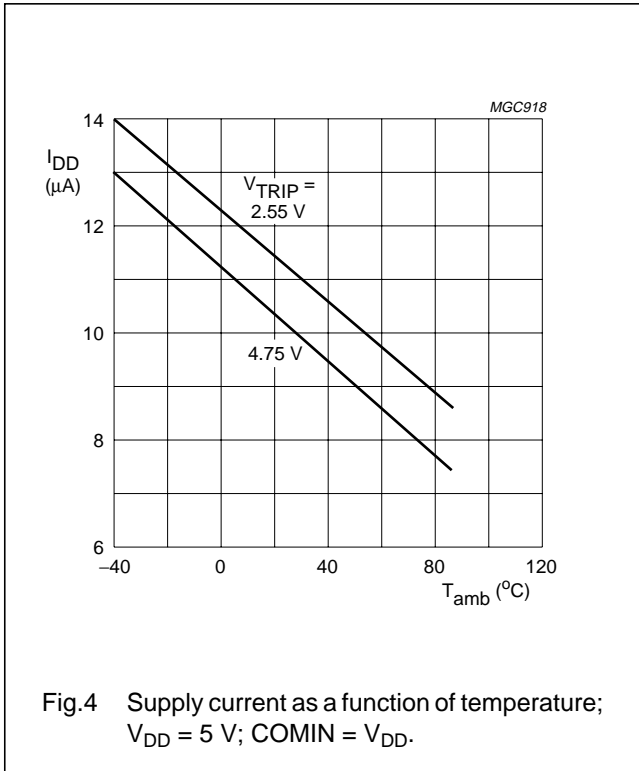

Threshold detector and reset generator

PCF1252-X family

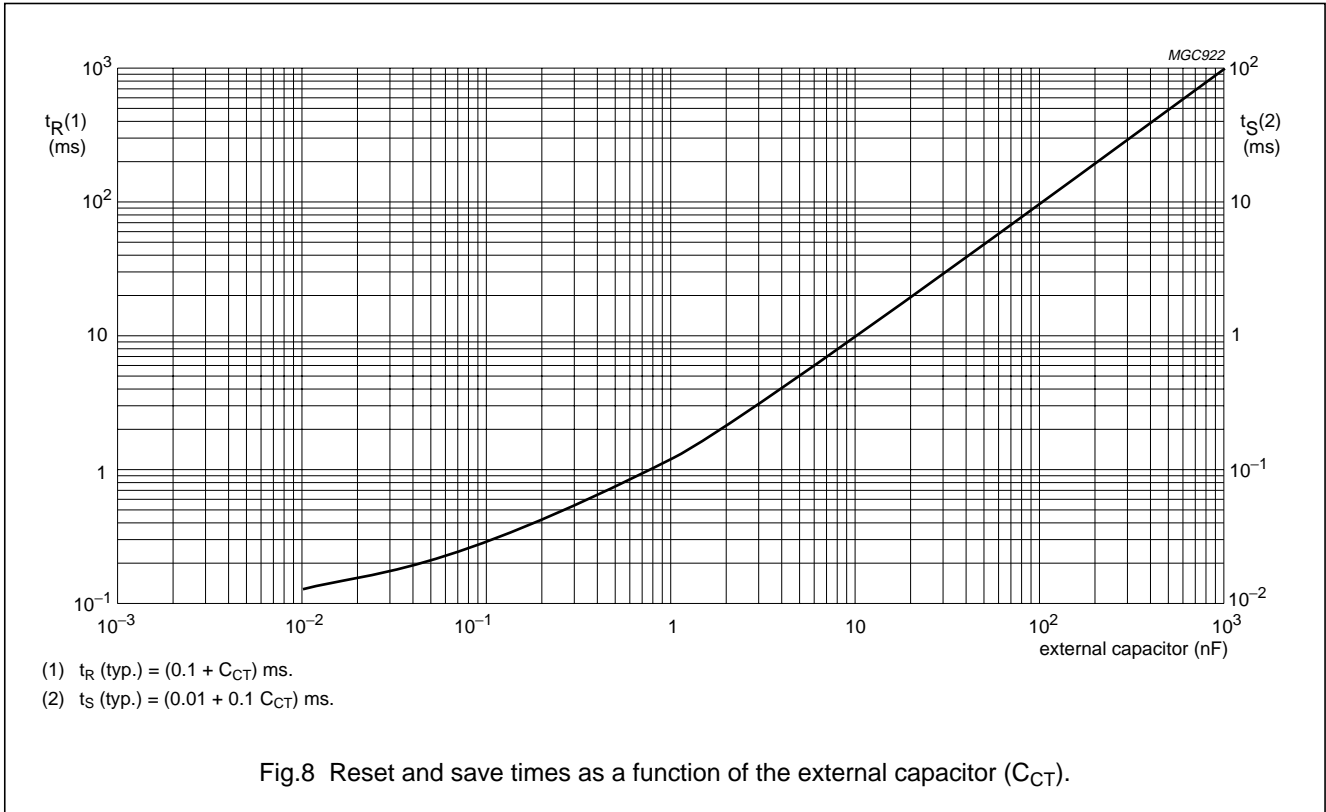

APPLICATION INFORMATION

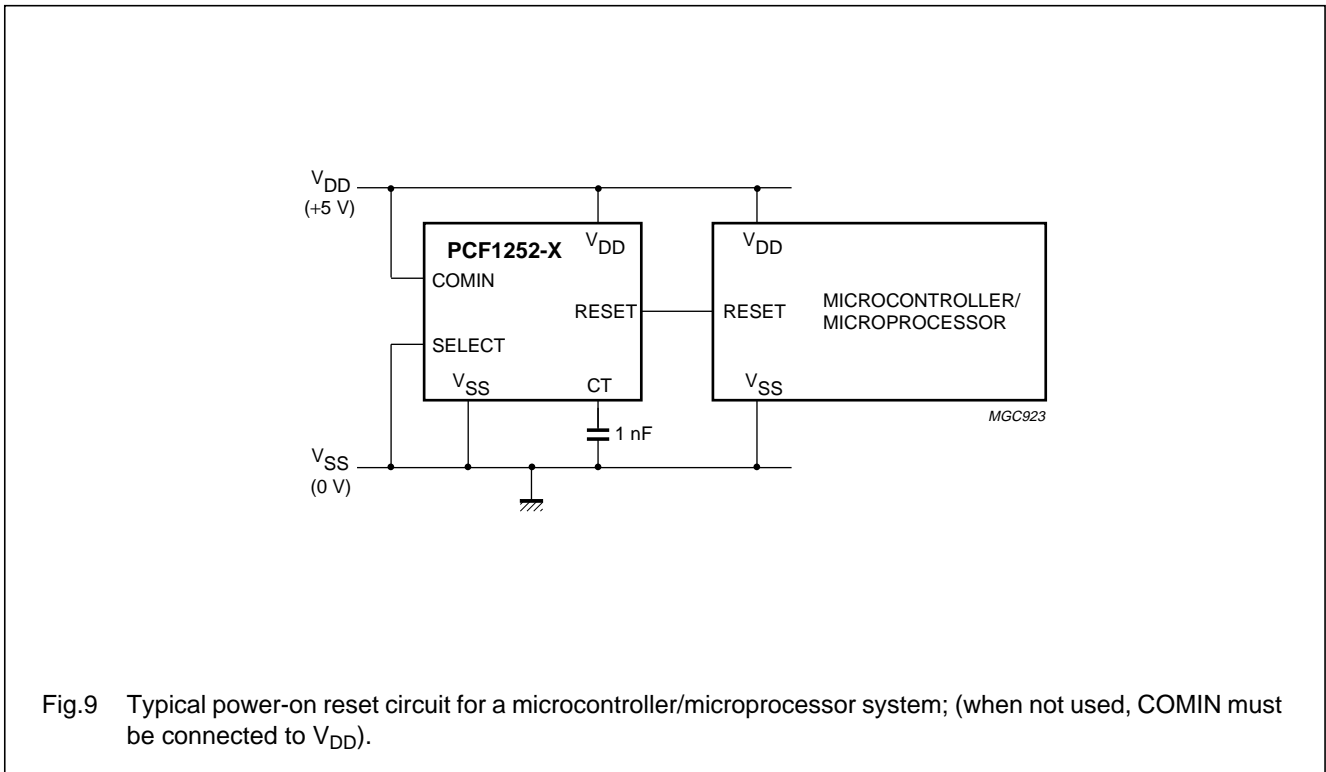

Threshold detector and reset generator

PCF1252-X family

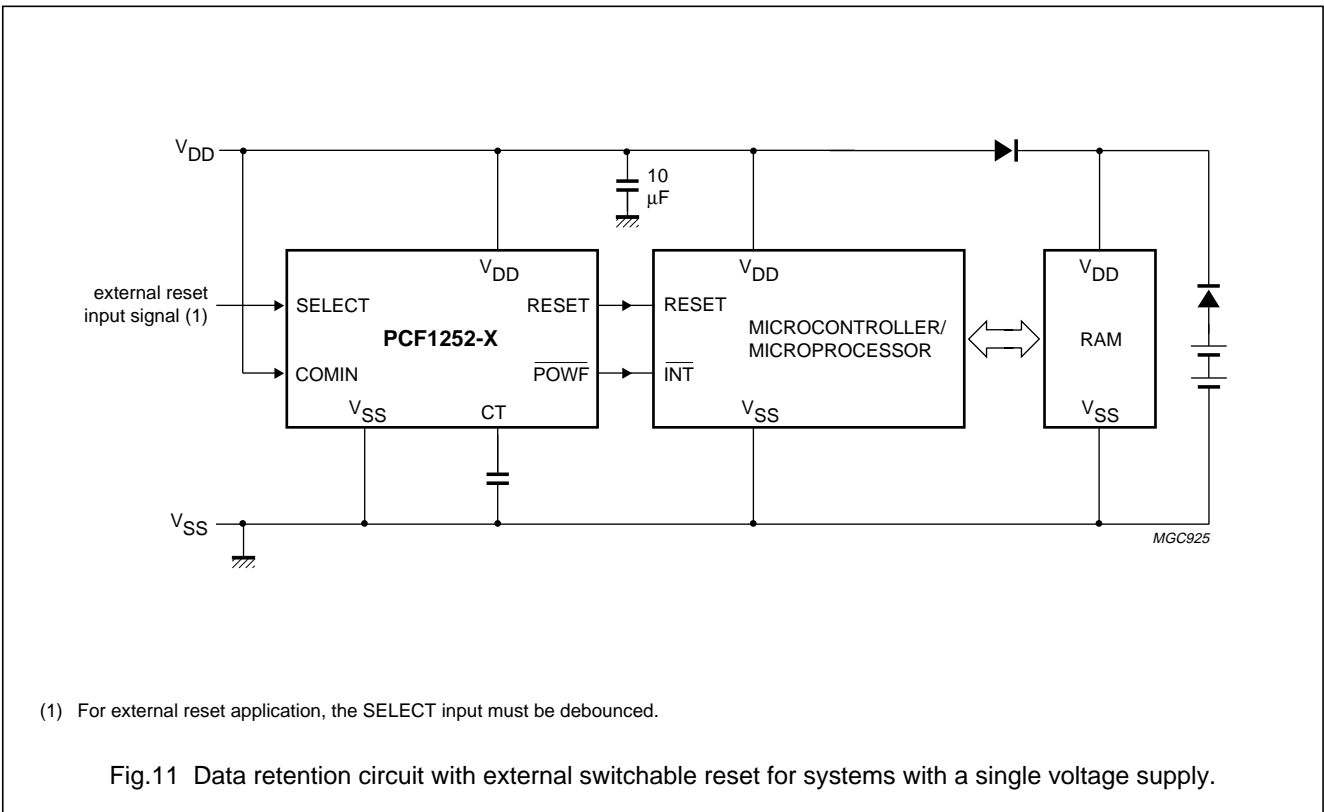
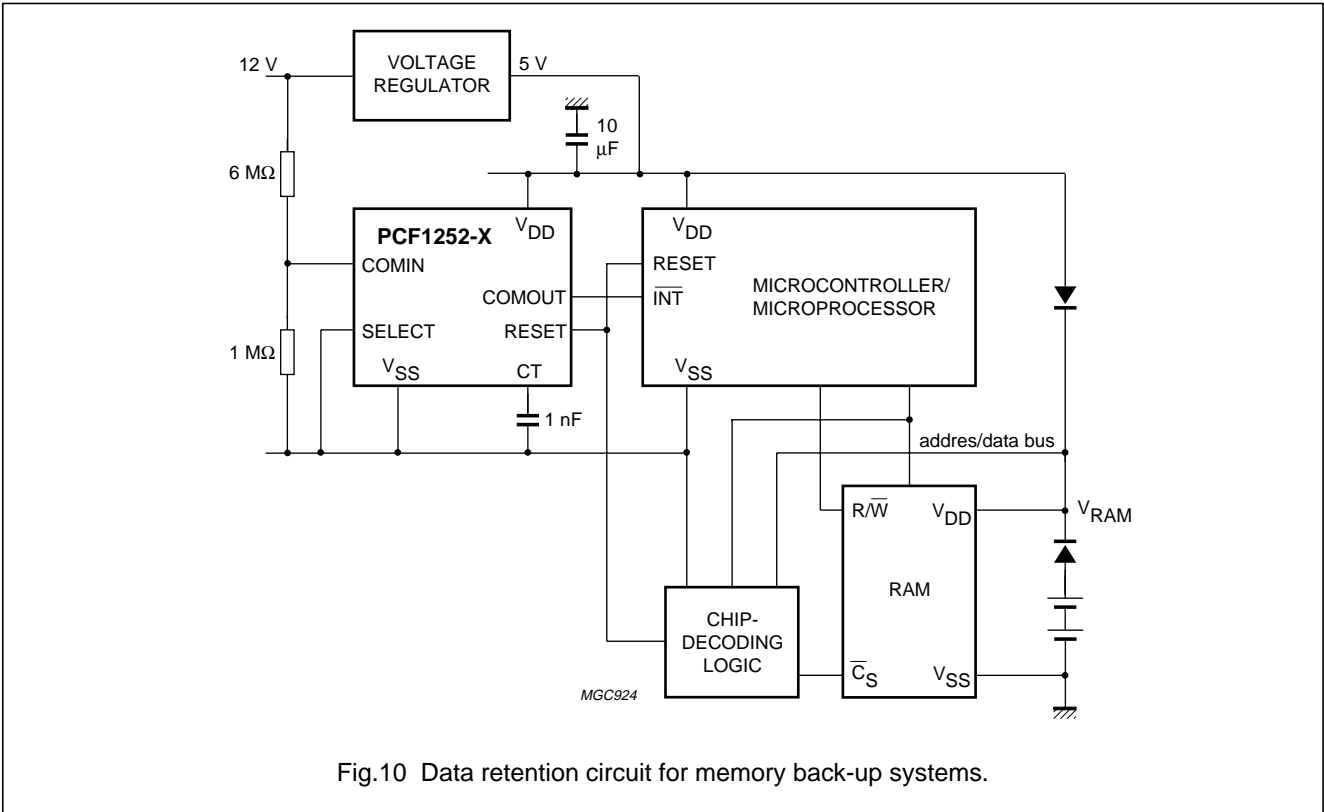

Threshold detector and reset generator

PCF1252-X family

PACKAGE OUTLINES

DIP8: plastic dual in-line package; 8 leads (300 mil)

SOT97-1

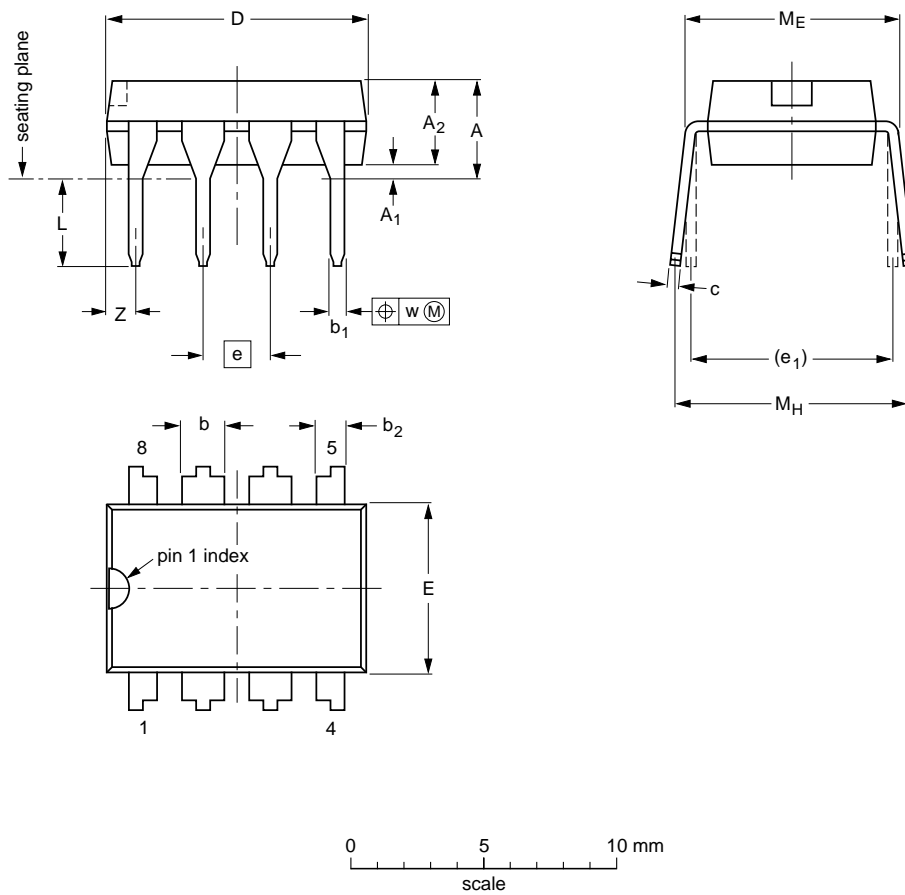

DIMENSIONS (inch dimensions are derived from the original mm dimensions)

UNIT	A max.	A ₁ min.	A ₂ max.	b	b ₁	b ₂	c	D ⁽¹⁾	E ⁽¹⁾	e	e ₁	L	M _E	M _H	w	Z ⁽¹⁾ max.
mm	4.2	0.51	3.2	1.73 1.14	0.53 0.38	1.07 0.89	0.36 0.23	9.8 9.2	6.48 6.20	2.54	7.62	3.60 3.05	8.25 7.80	10.0 8.3	0.254	1.15
inches	0.17	0.020	0.13	0.068 0.045	0.021 0.015	0.042 0.035	0.014 0.009	0.39 0.36	0.26 0.24	0.10	0.30	0.14 0.12	0.32 0.31	0.39 0.33	0.01	0.045

Note

1. Plastic or metal protrusions of 0.25 mm maximum per side are not included.

OUTLINE VERSION	REFERENCES				EUROPEAN PROJECTION	ISSUE DATE
	IEC	JEDEC	EIAJ			
SOT97-1	050G01	MO-001AN				92-11-17 95-02-04

Threshold detector and reset generator

PCF1252-X family

S08: plastic small outline package; 8 leads; body width 3.9 mm

SOT96-1

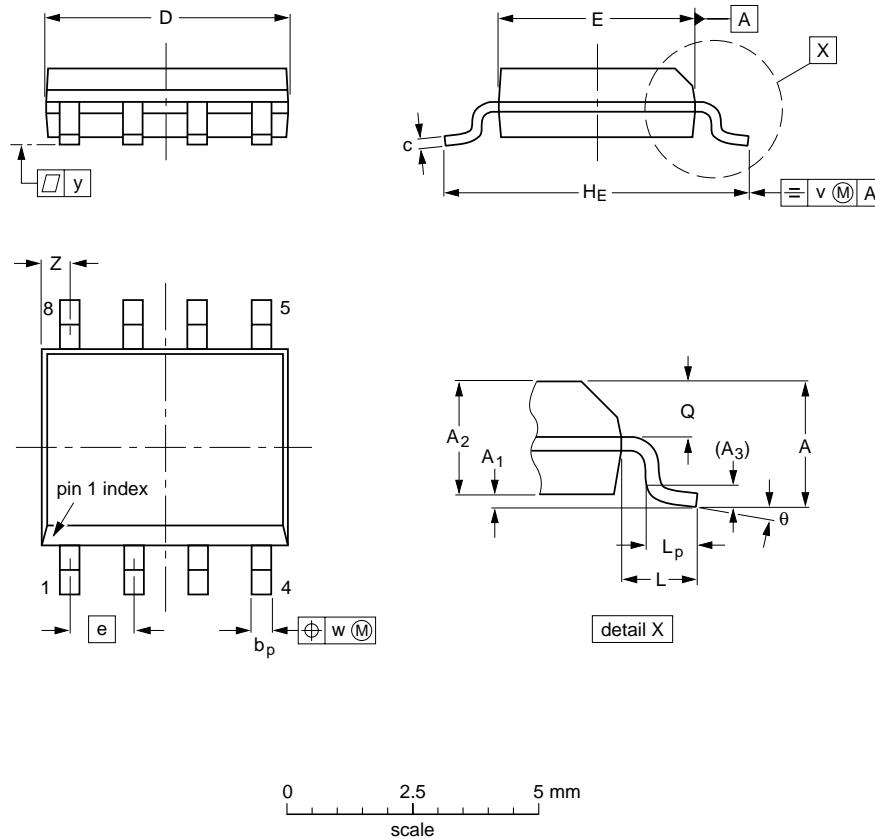

DIMENSIONS (inch dimensions are derived from the original mm dimensions)

UNIT	A max.	A ₁	A ₂	A ₃	b _p	c	D ⁽¹⁾	E ⁽²⁾	e	H _E	L	L _p	Q	v	w	y	z ⁽¹⁾	θ
mm	1.75	0.25 0.10	1.45 1.25	0.25	0.49 0.36	0.25 0.19	5.0 4.8	4.0 3.8	1.27	6.2 5.8	1.05	1.0 0.4	0.7 0.6	0.25	0.25	0.1	0.7 0.3	8° 0°
inches	0.069	0.010 0.004	0.057 0.049	0.01	0.019 0.014	0.0100 0.0075	0.20 0.19	0.16 0.15	0.050	0.244 0.228	0.041	0.039 0.016	0.028 0.024	0.01	0.01	0.004	0.028 0.012	

Notes

1. Plastic or metal protrusions of 0.15 mm maximum per side are not included.
2. Plastic or metal protrusions of 0.25 mm maximum per side are not included.

OUTLINE VERSION	REFERENCES			EUROPEAN PROJECTION	ISSUE DATE
	IEC	JEDEC	EIAJ		
SOT96-1	076E03S	MS-012AA			95-02-04 97-05-22

Threshold detector and reset generator

PCF1252-X family

SOLDERING

Introduction

There is no soldering method that is ideal for all IC packages. Wave soldering is often preferred when through-hole and surface mounted components are mixed on one printed-circuit board. However, wave soldering is not always suitable for surface mounted ICs, or for printed-circuits with high population densities. In these situations reflow soldering is often used.

This text gives a very brief insight to a complex technology. A more in-depth account of soldering ICs can be found in our *"Data Handbook IC26; Integrated Circuit Packages"* (order code 9398 652 90011).

DIP

SOLDERING BY DIPPING OR BY WAVE

The maximum permissible temperature of the solder is 260 °C; solder at this temperature must not be in contact with the joint for more than 5 seconds. The total contact time of successive solder waves must not exceed 5 seconds.

The device may be mounted up to the seating plane, but the temperature of the plastic body must not exceed the specified maximum storage temperature ($T_{stg\ max}$). If the printed-circuit board has been pre-heated, forced cooling may be necessary immediately after soldering to keep the temperature within the permissible limit.

REPAIRING SOLDERED JOINTS

Apply a low voltage soldering iron (less than 24 V) to the lead(s) of the package, below the seating plane or not more than 2 mm above it. If the temperature of the soldering iron bit is less than 300 °C it may remain in contact for up to 10 seconds. If the bit temperature is between 300 and 400 °C, contact may be up to 5 seconds.

SO

REFLOW SOLDERING

Reflow soldering techniques are suitable for all SO packages.

Reflow soldering requires solder paste (a suspension of fine solder particles, flux and binding agent) to be applied to the printed-circuit board by screen printing, stencilling or pressure-syringe dispensing before package placement.

Several techniques exist for reflowing; for example, thermal conduction by heated belt. Dwell times vary between 50 and 300 seconds depending on heating method. Typical reflow temperatures range from 215 to 250 °C.

Preheating is necessary to dry the paste and evaporate the binding agent. Preheating duration: 45 minutes at 45 °C.

WAVE SOLDERING

Wave soldering techniques can be used for all SO packages if the following conditions are observed:

- A double-wave (a turbulent wave with high upward pressure followed by a smooth laminar wave) soldering technique should be used.
- The longitudinal axis of the package footprint must be parallel to the solder flow.
- The package footprint must incorporate solder thieves at the downstream end.

During placement and before soldering, the package must be fixed with a droplet of adhesive. The adhesive can be applied by screen printing, pin transfer or syringe dispensing. The package can be soldered after the adhesive is cured.

Maximum permissible solder temperature is 260 °C, and maximum duration of package immersion in solder is 10 seconds, if cooled to less than 150 °C within 6 seconds. Typical dwell time is 4 seconds at 250 °C.

A mildly-activated flux will eliminate the need for removal of corrosive residues in most applications.

REPAIRING SOLDERED JOINTS

Fix the component by first soldering two diagonally-opposite end leads. Use only a low voltage soldering iron (less than 24 V) applied to the flat part of the lead. Contact time must be limited to 10 seconds at up to 300 °C. When using a dedicated tool, all other leads can be soldered in one operation within 2 to 5 seconds between 270 and 320 °C.

Threshold detector and reset generator

PCF1252-X family

DEFINITIONS

Data sheet status	
Objective specification	This data sheet contains target or goal specifications for product development.
Preliminary specification	This data sheet contains preliminary data; supplementary data may be published later.
Product specification	This data sheet contains final product specifications.
Limiting values	
Limiting values given are in accordance with the Absolute Maximum Rating System (IEC 134). Stress above one or more of the limiting values may cause permanent damage to the device. These are stress ratings only and operation of the device at these or at any other conditions above those given in the Characteristics sections of the specification is not implied. Exposure to limiting values for extended periods may affect device reliability.	
Application information	
Where application information is given, it is advisory and does not form part of the specification.	

LIFE SUPPORT APPLICATIONS

These products are not designed for use in life support appliances, devices, or systems where malfunction of these products can reasonably be expected to result in personal injury. Philips customers using or selling these products for use in such applications do so at their own risk and agree to fully indemnify Philips for any damages resulting from such improper use or sale.

Threshold detector and reset generator

PCF1252-X family

NOTES

Threshold detector and reset generator

PCF1252-X family

NOTES

Philips Semiconductors – a worldwide company

Argentina: see South America

Australia: 34 Waterloo Road, NORTH RYDE, NSW 2113, Tel. +61 2 9805 4455, Fax. +61 2 9805 4466

Austria: Computerstr. 6, A-1101 WIEN, P.O. Box 213, Tel. +43 160 1010, Fax. +43 160 101 1210

Belarus: Hotel Minsk Business Center, Bld. 3, r. 1211, Volodarski Str. 6, 220050 MINSK, Tel. +375 172 200 733, Fax. +375 172 200 773

Belgium: see The Netherlands

Brazil: see South America

Bulgaria: Philips Bulgaria Ltd., Energoproject, 15th floor, 51 James Bourchier Blvd., 1407 SOFIA, Tel. +359 2 689 211, Fax. +359 2 689 102

Canada: PHILIPS SEMICONDUCTORS/COMPONENTS, Tel. +1 800 234 7381

China/Hong Kong: 501 Hong Kong Industrial Technology Centre, 72 Tat Chee Avenue, Kowloon Tong, HONG KONG, Tel. +852 2319 7888, Fax. +852 2319 7700

Colombia: see South America

Czech Republic: see Austria

Denmark: Prags Boulevard 80, PB 1919, DK-2300 COPENHAGEN S, Tel. +45 32 88 2636, Fax. +45 31 57 0044

Finland: Sinikalliontie 3, FIN-02630 ESPOO, Tel. +358 9 615800, Fax. +358 9 61580920

France: 51 Rue Carnot, BP317, 92156 SURESNES Cedex, Tel. +33 1 40 99 6161, Fax. +33 1 40 99 6427

Germany: Hammerbrookstraße 69, D-20097 HAMBURG, Tel. +49 40 23 53 60, Fax. +49 40 23 536 300

Greece: No. 15, 25th March Street, GR 17778 TAVROS/ATHENS, Tel. +30 1 4894 339/239, Fax. +30 1 4814 240

Hungary: see Austria

India: Philips INDIA Ltd, Band Box Building, 2nd floor, 254-D, Dr. Annie Besant Road, Worli, MUMBAI 400 025, Tel. +91 22 493 8541, Fax. +91 22 493 0966

Indonesia: PT Philips Development Corporation, Semiconductors Division, Gedung Philips, Jl. Buncit Raya Kav.99-100, JAKARTA 12510, Tel. +62 21 794 0040 ext. 2501, Fax. +62 21 794 0080

Ireland: Newstead, Clonskeagh, DUBLIN 14, Tel. +353 1 7640 000, Fax. +353 1 7640 200

Israel: RAPAC Electronics, 7 Kehilat Saloniki St, PO Box 18053, TEL AVIV 61180, Tel. +972 3 645 0444, Fax. +972 3 649 1007

Italy: PHILIPS SEMICONDUCTORS, Piazza IV Novembre 3, 20124 MILANO, Tel. +39 2 6752 2531, Fax. +39 2 6752 2557

Japan: Philips Bldg 13-37, Kohnan 2-chome, Minato-ku, TOKYO 108, Tel. +81 3 3740 5130, Fax. +81 3 3740 5077

Korea: Philips House, 260-199 Itaewon-dong, Yongsan-ku, SEOUL, Tel. +82 2 709 1412, Fax. +82 2 709 1415

Malaysia: No. 76 Jalan Universiti, 46200 PETALING JAYA, SELANGOR, Tel. +60 3 750 5214, Fax. +60 3 757 4880

Mexico: 5900 Gateway East, Suite 200, EL PASO, TEXAS 79905, Tel. +9-5 800 234 7381

Middle East: see Italy

Netherlands: Postbus 90050, 5600 PB EINDHOVEN, Bldg. VB, Tel. +31 40 27 82785, Fax. +31 40 27 88399

New Zealand: 2 Wagener Place, C.P.O. Box 1041, AUCKLAND, Tel. +64 9 849 4160, Fax. +64 9 849 7811

Norway: Box 1, Manglerud 0612, OSLO, Tel. +47 22 74 8000, Fax. +47 22 74 8341

Pakistan: see Singapore

Philippines: Philips Semiconductors Philippines Inc., 106 Valero St. Salcedo Village, P.O. Box 2108 MCC, MAKATI, Metro MANILA, Tel. +63 2 816 6380, Fax. +63 2 817 3474

Poland: Ul. Lukiska 10, PL 04-123 WARSZAWA, Tel. +48 22 612 2831, Fax. +48 22 612 2327

Portugal: see Spain

Romania: see Italy

Russia: Philips Russia, Ul. Usatcheva 35A, 119048 MOSCOW, Tel. +7 095 755 6918, Fax. +7 095 755 6919

Singapore: Lorong 1, Toa Payoh, SINGAPORE 319762, Tel. +65 350 2538, Fax. +65 251 6500

Slovakia: see Austria

Slovenia: see Italy

South Africa: S.A. PHILIPS Pty Ltd., 195-215 Main Road Martindale, 2092 JOHANNESBURG, P.O. Box 7430 Johannesburg 2000, Tel. +27 11 470 5911, Fax. +27 11 470 5494

South America: Al. Vicente Pinzon, 173, 6th floor, 04547-130 SÃO PAULO, SP, Brazil, Tel. +55 11 821 2333, Fax. +55 11 821 2382

Spain: Balmes 22, 08007 BARCELONA, Tel. +34 3 301 6312, Fax. +34 3 301 4107

Sweden: Kottbygatan 7, Akalla, S-16485 STOCKHOLM, Tel. +46 8 5985 2000, Fax. +46 8 5985 2745

Switzerland: Allmendstrasse 140, CH-8027 ZÜRICH, Tel. +41 1 488 2741 Fax. +41 1 488 3263

Taiwan: Philips Semiconductors, 6F, No. 96, Chien Kuo N. Rd., Sec. 1, TAIPEI, Taiwan Tel. +886 2 2134 2865, Fax. +886 2 2134 2874

Thailand: PHILIPS ELECTRONICS (THAILAND) Ltd., 209/2 Sanpavuth-Bangna Road Prakanong, BANGKOK 10260, Tel. +66 2 745 4090, Fax. +66 2 398 0793

Turkey: Talatpasa Cad. No. 5, 80640 GÜLTEPE/ISTANBUL, Tel. +90 212 279 2770, Fax. +90 212 282 6707

Ukraine: PHILIPS UKRAINE, 4 Patrice Lumumba str., Building B, Floor 7, 252042 KIEV, Tel. +380 44 264 2776, Fax. +380 44 268 0461

United Kingdom: Philips Semiconductors Ltd., 276 Bath Road, Hayes, MIDDLESEX UB3 5BX, Tel. +44 181 730 5000, Fax. +44 181 754 8421

United States: 811 East Arques Avenue, SUNNYVALE, CA 94088-3409, Tel. +1 800 234 7381

Uruguay: see South America

Vietnam: see Singapore

Yugoslavia: PHILIPS, Trg N. Pasica 5/v, 11000 BEOGRAD, Tel. +381 11 625 344, Fax. +381 11 635 777

For all other countries apply to: Philips Semiconductors, International Marketing & Sales Communications, Building BE-p, P.O. Box 218, 5600 MD EINDHOVEN, The Netherlands, Fax. +31 40 27 24825

Internet: <http://www.semiconductors.philips.com>

© Philips Electronics N.V. 1998

SCA59

All rights are reserved. Reproduction in whole or in part is prohibited without the prior written consent of the copyright owner.

The information presented in this document does not form part of any quotation or contract, is believed to be accurate and reliable and may be changed without notice. No liability will be accepted by the publisher for any consequence of its use. Publication thereof does not convey nor imply any license under patent- or other industrial or intellectual property rights.

Printed in The Netherlands

295102/1200/03/pp16

Date of release: 1998 Apr 16

Document order number: 9397 750 03645

Let's make things better.

**Philips
Semiconductors**



PHILIPS

Looking for pricing, stock, or lifecycle information?

Click below to explore more details on WIN SOURCE:

- [View PCF1252-1T/F4,112 on WIN SOURCE](#)
- [NXP / Nexperia Information](#)

Optimize Your Supply Chain with WIN SOURCE Solutions

- ✓ Global Sourcing Solution
- ✓ Obsolete Management
- ✓ Cost Control Management
- ✓ Shortage Management
- ✓ Alternative Solution
- ✓ Excess Inventory Management