



THE DATASHEET OF PC81410NSZ



PC8141xNSZ Series

DIP 4pin High CMR,
AC Input, Low Input Current
Photocoupler

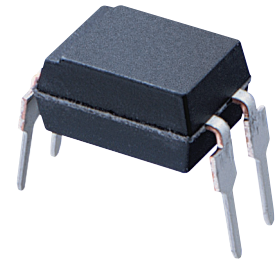

■ Description

PC8141xNSZ Series contains an IRED optically coupled to a phototransistor.

It is packaged in a 4-pin DIP, available in SMT gullwing lead-form option.

Input-output isolation voltage(rms) is 5.0kV.

Collector-emitter voltage is 80V(*), CTR is 50% to 600% at input current of $\pm 0.5\text{mA}$ and CMR is MIN. 10kV/ μs .

■ Features

1. 4-pin DIP package
2. Double transfer mold package (Ideal for Flow Soldering)
3. AC input type
4. Low input current type ($I_F = \pm 0.5\text{mA}$)
5. High collector-emitter voltage ($V_{CEO} : 80\text{V}^{(*)}$)
6. High noise immunity due to high common rejection voltage (CMR : MIN. 10kV/ μs)
7. High isolation voltage between input and output ($V_{iso(rms)} : 5.0\text{ kV}$)

(*)Up to Date code "P8"(August 2002) $V_{CEO}:70\text{V}$.

■ Agency approvals/Compliance

1. Recognized by UL1577 (Double protection isolation), file No. E64380 (as model No. **PC8141**)
2. Package resin : UL flammability grade (94V-0)

■ Applications

1. Programmable controllers
2. Facsimiles
3. Telephones

Notice The content of data sheet is subject to change without prior notice.

In the absence of confirmation by device specification sheets, SHARP takes no responsibility for any defects that may occur in equipment using any SHARP devices shown in catalogs, data books, etc. Contact SHARP in order to obtain the latest device specification sheets before using any SHARP device.

Internal Connection Diagram

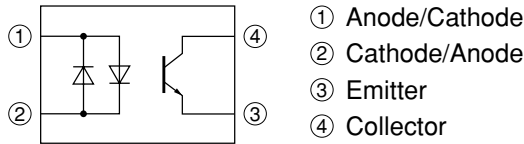

Outline Dimensions

(Unit : mm)

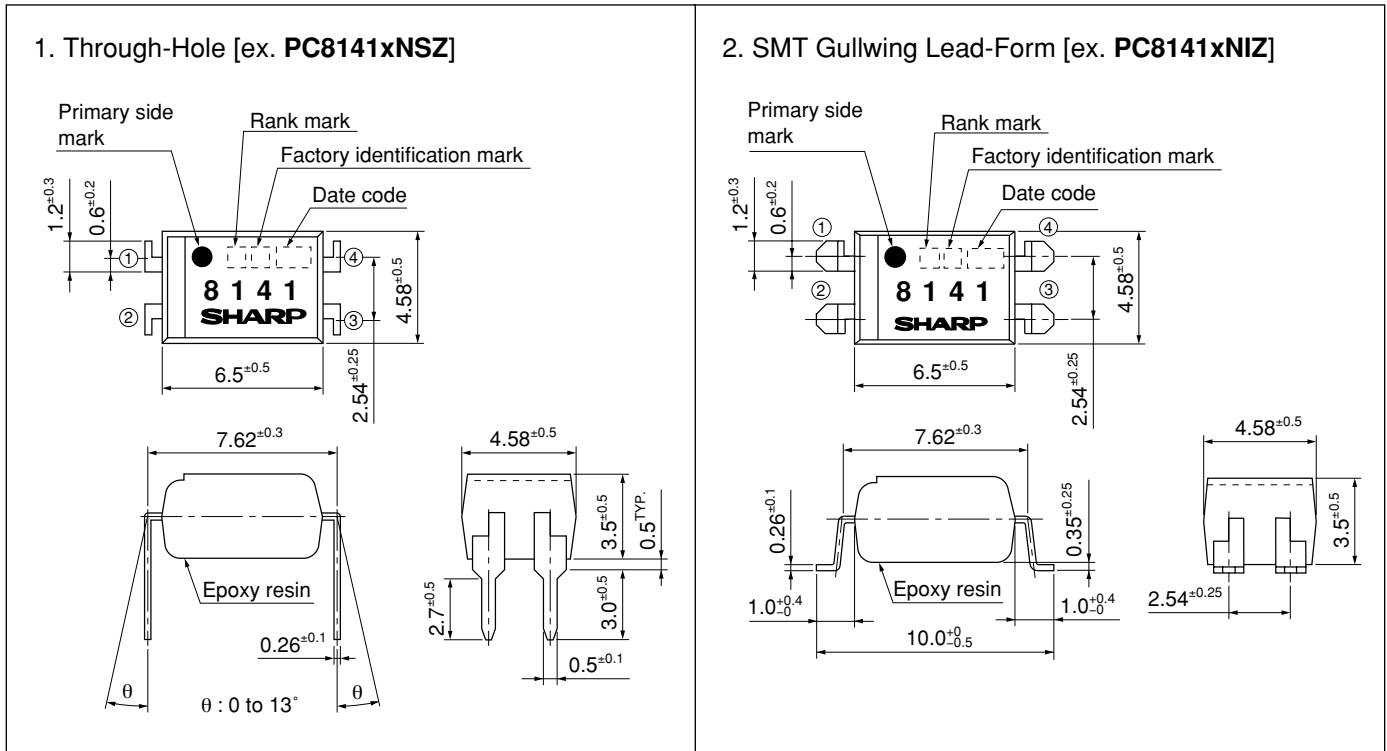

Product mass : approx. 0.25g

Date code (2 digit)

1st digit				2nd digit	
Year of production				Month of production	
A.D.	Mark	A.D.	Mark	Month	Mark
1990	A	2002	P	January	1
1991	B	2003	R	February	2
1992	C	2004	S	March	3
1993	D	2005	T	April	4
1994	E	2006	U	May	5
1995	F	2007	V	June	6
1996	H	2008	W	July	7
1997	J	2009	X	August	8
1998	K	2010	A	September	9
1999	L	2011	B	October	O
2000	M	2012	C	November	N
2001	N	∴	∴	December	D

repeats in a 20 year cycle

Factory identification mark

Factory identification Mark	Country of origin
no mark	Japan
	
	Indonesia
	Philippines
	China

* This factory making is for identification purpose only.
Please contact the local SHARP sales representative to see the actual status of the production.

Rank mark

Refer to the Model Line-up table

■ Absolute Maximum Ratings (T_a=25°C)

	Parameter	Symbol	Rating	Unit
Input	Forward current	I _F	±10	mA
	*1 Peak forward current	I _{FM}	±200	mA
	Power dissipation	P	15	mW
Output	Collector-emitter voltage	V _{CEO}	*4 80	V
	Emitter-collector voltage	V _{ECO}	6	V
	Collector current	I _C	50	mA
	Collector power dissipation	P _C	150	mW
Total power dissipation		P _{tot}	170	mW
*2 Isolation voltage		V _{iso (rms)}	5.0	kV
Operating temperature		T _{opr}	-30 to +100	°C
Storage temperature		T _{stg}	-55 to +125	°C
*3 Soldering temperature		T _{sol}	260	°C

*1 Pulse width ≤ 100μs, Duty ratio : 0.001

*2 40 to 60%RH, AC for 1 minute, f=60Hz

*3 For 10s

*4 Up to Date code "P8"(August 2002)V_{CEO}:70V.

■ Electro-optical Characteristics (T_a=25°C)

	Parameter	Symbol	Conditions	MIN.	TYP.	MAX.	Unit	
Input	Forward voltage	V _F	I _F =±10mA	-	1.2	1.4	V	
	Terminal capacitance	C _t	V=0, f=1kHz	-	30	250	pF	
	Collector dark current	I _{CEO}	V _{CE} =50V, I _F =0	-	-	100	nA	
Output	Collector-emitter breakdown voltage	BV _{CEO}	I _C =0.1mA, I _F =0	*5 80	-	-	V	
	Emitter-collector breakdown voltage	BV _{ECO}	I _E =10μA, I _F =0	6	-	-	V	
	Collector current	I _C	I _F =±0.5mA, V _{CE} =5V	0.25	-	2.0	mA	
Transfer characteristics	Collector-emitter saturation voltage	V _{CE (sat)}	I _F =±10mA, I _C =1mA	-	-	0.2	V	
	Isolation resistance	R _{ISO}	DC500V, 40 to 60%RH	5×10 ¹⁰	1×10 ¹¹	-	Ω	
	Floating capacitance	C _f	V=0, f=1MHz	-	0.6	1.0	pF	
	Response time	Rise time	t _r	V _{CE} =2V, I _C =2mA, R _L =100Ω	-	4	18	μs
		Fall time	t _f		-	3	18	μs
Common mode rejection voltage		CMR	T _a =25°C, R _L =470Ω, V _{CM} =1.5kV(peak) I _F =0, V _{CC} =9V, V _{np} =100mV	10	-	-	kV/μs	

*5 Up to Date code "P8"(August 2002)BV_{CEO}:70V.

■ Model Line-up

Lead Form	Through-Hole	SMT Gullwing	Rank mark	I _C [mA] (I _F =±0.5mA, V _{CE} =5V, T _a =25°C)
Package	Sleeve 100pcs/sleeve			
Model No.	PC81410NSZ	PC81410NIZ	with or without	0.25 to 2.0
	PC81411NSZ	PC81411NIZ	A	0.5 to 1.5

Please contact a local SHARP sales representative to inquire about production status and Lead-Free options.

Fig.1 Test Circuit for Common Mode Rejection Voltage

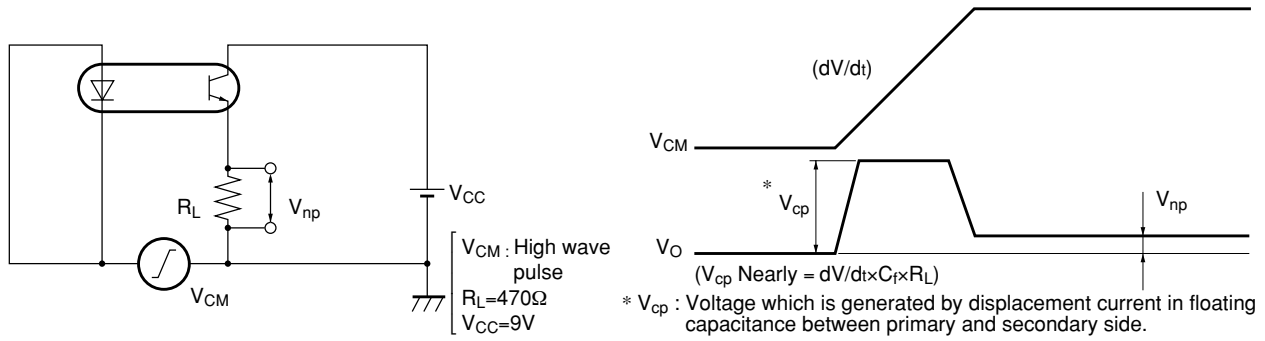

Fig.2 Forward Current vs. Ambient Temperature

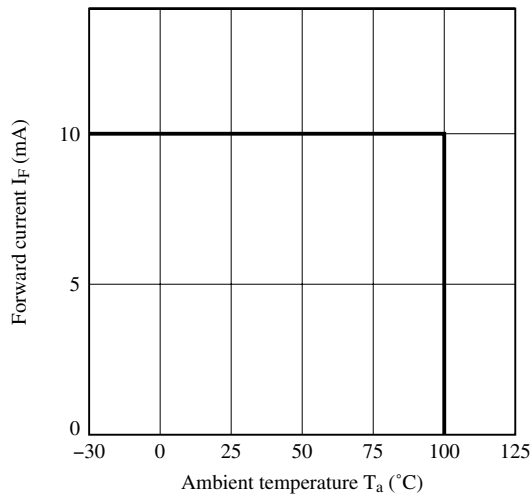

Fig.3 Diode Power Dissipation vs. Ambient Temperature

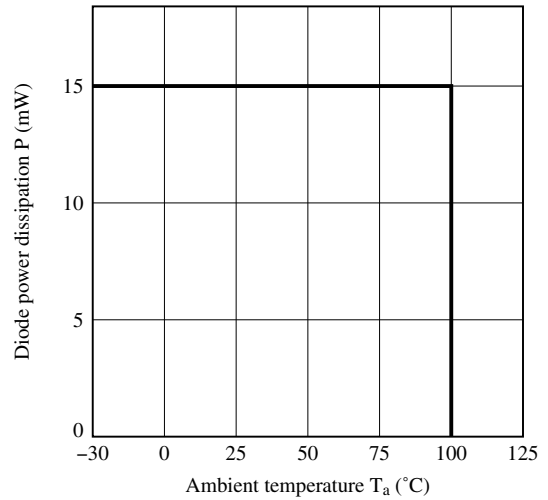

Fig.4 Collector Power Dissipation vs. Ambient Temperature

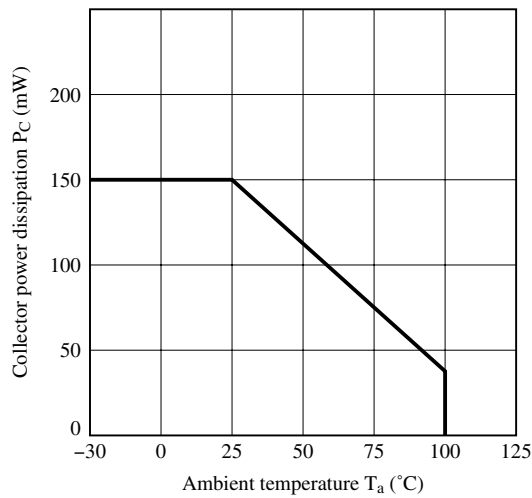

Fig.5 Total Power Dissipation vs. Ambient Temperature

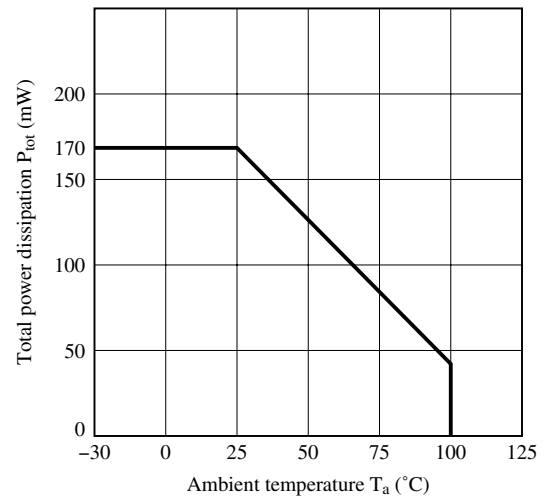

Fig.6 Peak Forward Current vs. Duty Ratio

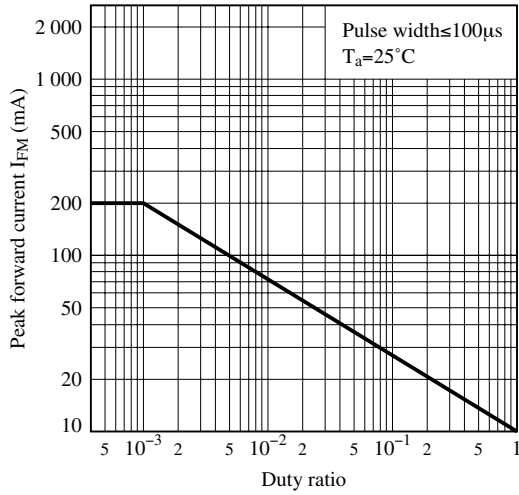

Fig.7 Forward Current vs. Forward Voltage

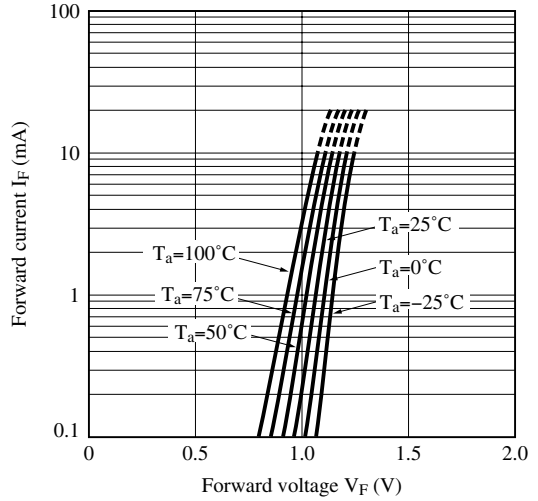

Fig.8 Current Transfer Ratio vs. Forward Current

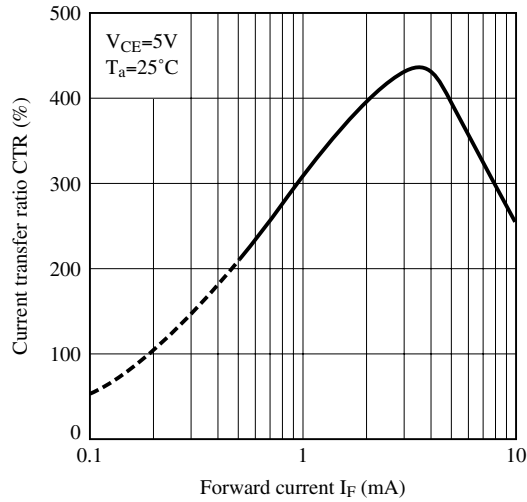

Fig.9 Collector Current vs. Collector-emitter Voltage

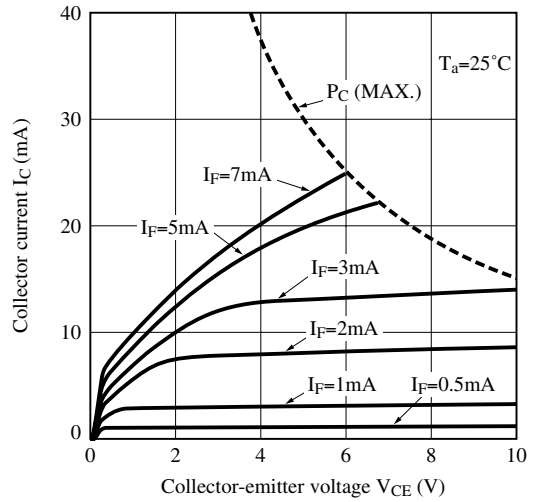

Fig.10 Relative Current Transfer Ratio vs. Ambient Temperature

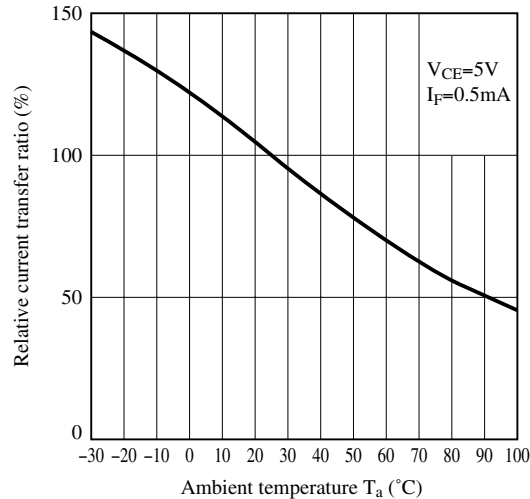

Fig.11 Collector - emitter Saturation Voltage vs. Ambient Temperature

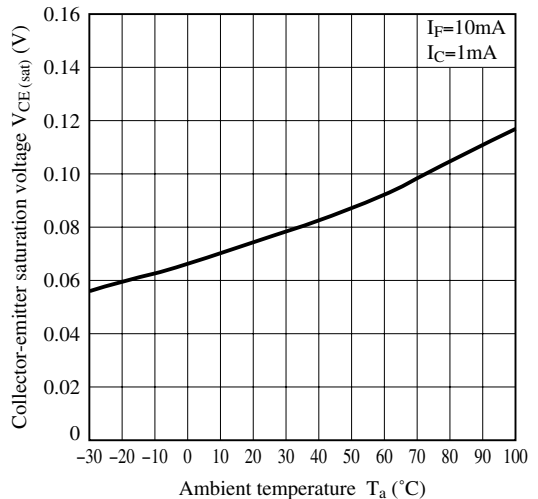

Fig.12 Collector Dark Current vs. Ambient Temperature

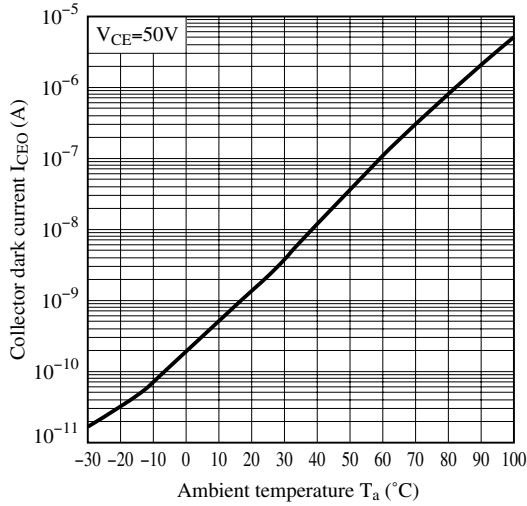

Fig.13 Response Time vs. Load Resistance (active region)

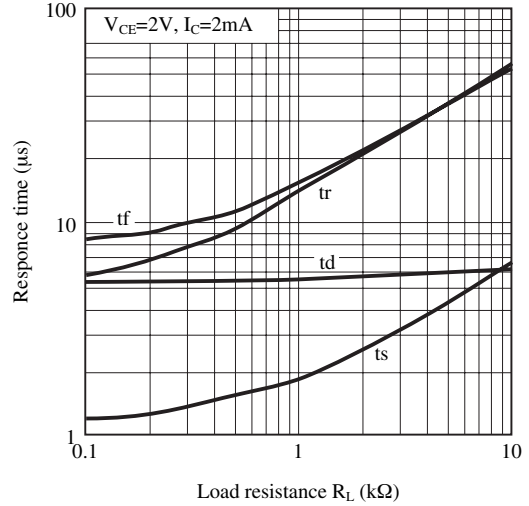

Fig.14 Response Time vs. Load Resistance (saturation region)

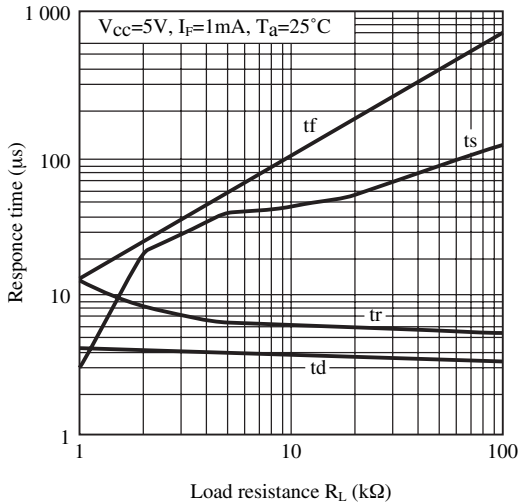
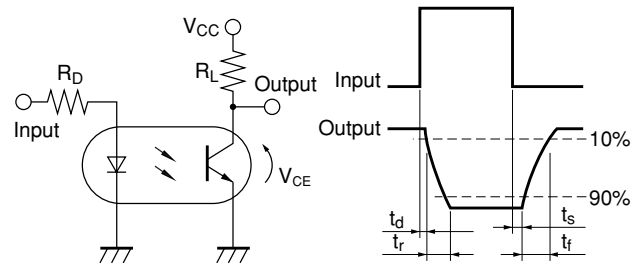

Fig.15 Test Circuit for Response Time



Please refer to the conditions in Fig.13 and Fig.14.

Fig.16 Frequency Response

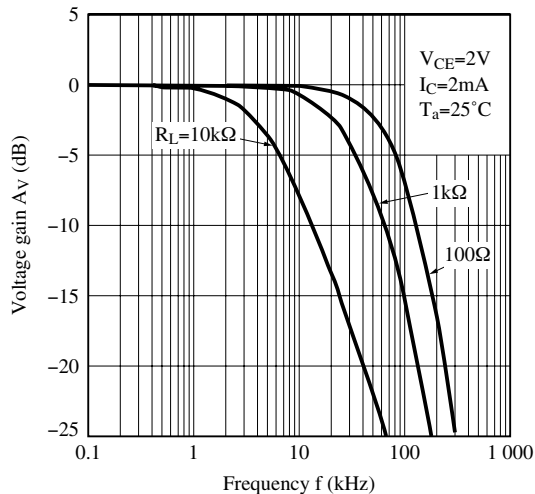
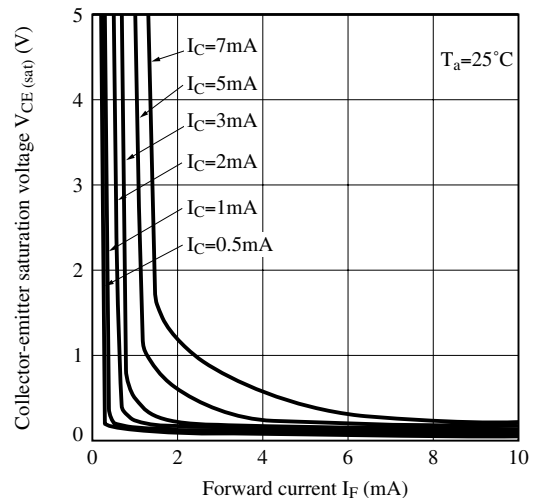

Fig.17 Collector-emitter Saturation Voltage vs. Forward Current



Remarks : Please be aware that all data in the graph are just for reference and not for guarantee.

■ Design Considerations

● Design guide

While operating at $I_F < 0.5\text{mA}$, CTR variation may increase.
Please make design considering this fact.

In case that some sudden big noise caused by voltage variation is provided between primary and secondary terminals of photocoupler some current caused by it is floating capacitance may be generated and result in false operation since current may go through IRED or current may change.

If the photocoupler may be used under the circumstances where noise will be generated we recommend to use the bypass capacitors at the both ends of IRED.

This product is not designed against irradiation and incorporates non-coherent IRED.

● Degradation

In general, the emission of the IRED used in photocouplers will degrade over time.

In the case of long term operation, please take the general IRED degradation (50% degradation over 5years) into the design consideration.

● Recommended Foot Print (reference)

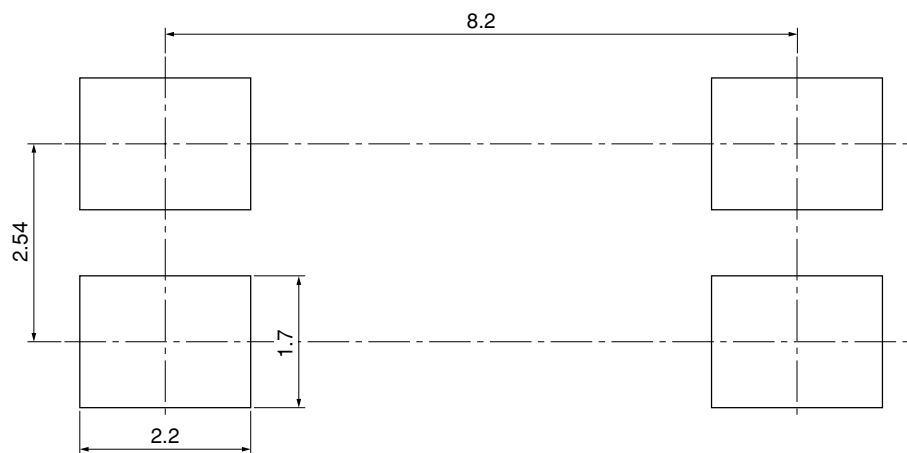

☆ For additional design assistance, please review our corresponding Optoelectronic Application Notes.

■ Manufacturing Guidelines

● Soldering Method

Reflow Soldering:

Reflow soldering should follow the temperature profile shown below.

Soldering should not exceed the curve of temperature profile and time.

Please don't solder more than twice.



Flow Soldering :

Due to SHARP's double transfer mold construction submersion in flow solder bath is allowed under the below listed guidelines.

Flow soldering should be completed below 270°C and within 10s.

Preheating is within the bounds of 100 to 150°C and 30 to 80s.

Please don't solder more than twice.

Hand soldering

Hand soldering should be completed within 3s when the point of solder iron is below 400°C.

Please don't solder more than twice.

Other notices

Please test the soldering method in actual condition and make sure the soldering works fine, since the impact on the junction between the device and PCB varies depending on the tooling and soldering conditions.

● Cleaning instructions**Solvent cleaning:**

Solvent temperature should be 45°C or below Immersion time should be 3minutes or less

Ultrasonic cleaning:

The impact on the device varies depending on the size of the cleaning bath, ultrasonic output, cleaning time, size of PCB and mounting method of the device.

Therefore, please make sure the device withstands the ultrasonic cleaning in actual conditions in advance of mass production.

Recommended solvent materials:

Ethyl alcohol, Methyl alcohol and Isopropyl alcohol

In case the other type of solvent materials are intended to be used, please make sure they work fine in actual using conditions since some materials may erode the packaging resin.

● Presence of ODC

This product shall not contain the following materials.

And they are not used in the production process for this device.

Regulation substances:CFCs, Halon, Carbon tetrachloride, 1.1.1-Trichloroethane (Methylchloroform)

Specific brominated flame retardants such as the PBBOs and PBBs are not used in this product at all.

■ **Package specification**

● **Sleeve package**

Package materials

Sleeve : HIPS (with anti-static material)

Stopper : Styrene-Elastomer

Package method

MAX. 100pcs of products shall be packaged in a sleeve.

Both ends shall be closed by tabbed and tabless stoppers.

The product shall be arranged in the sleeve with its primary side mark on the tabless stopper side.

MAX. 20 sleeves in one case.

Sleeve outline dimensions

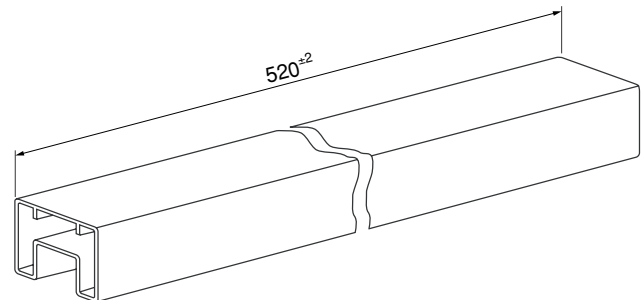
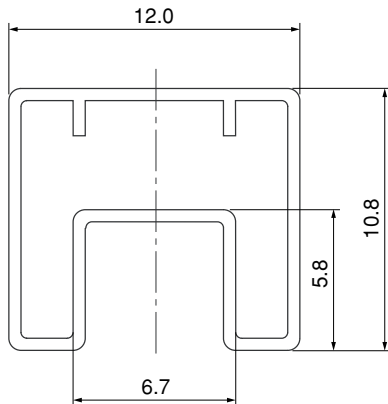

(Unit : mm)

■ Important Notices

· The circuit application examples in this publication are provided to explain representative applications of SHARP devices and are not intended to guarantee any circuit design or license any intellectual property rights. SHARP takes no responsibility for any problems related to any intellectual property right of a third party resulting from the use of SHARP's devices.

· Contact SHARP in order to obtain the latest device specification sheets before using any SHARP device. SHARP reserves the right to make changes in the specifications, characteristics, data, materials, structure, and other contents described herein at any time without notice in order to improve design or reliability. Manufacturing locations are also subject to change without notice.

· Observe the following points when using any devices in this publication. SHARP takes no responsibility for damage caused by improper use of the devices which does not meet the conditions and absolute maximum ratings to be used specified in the relevant specification sheet nor meet the following conditions:

(i) The devices in this publication are designed for use in general electronic equipment designs such as:

- Personal computers
- Office automation equipment
- Telecommunication equipment [terminal]
- Test and measurement equipment
- Industrial control
- Audio visual equipment
- Consumer electronics

(ii) Measures such as fail-safe function and redundant design should be taken to ensure reliability and safety when SHARP devices are used for or in connection

with equipment that requires higher reliability such as:

- Transportation control and safety equipment (i.e., aircraft, trains, automobiles, etc.)
- Traffic signals
- Gas leakage sensor breakers
- Alarm equipment
- Various safety devices, etc.

(iii) SHARP devices shall not be used for or in connection with equipment that requires an extremely high level of reliability and safety such as:

- Space applications
- Telecommunication equipment [trunk lines]
- Nuclear power control equipment
- Medical and other life support equipment (e.g., scuba).

· If the SHARP devices listed in this publication fall within the scope of strategic products described in the Foreign Exchange and Foreign Trade Law of Japan, it is necessary to obtain approval to export such SHARP devices.

· This publication is the proprietary product of SHARP and is copyrighted, with all rights reserved. Under the copyright laws, no part of this publication may be reproduced or transmitted in any form or by any means, electronic or mechanical, for any purpose, in whole or in part, without the express written permission of SHARP. Express written permission is also required before any use of this publication may be made by a third party.

· Contact and consult with a SHARP representative if there are any questions about the contents of this publication.

Looking for pricing, stock, or lifecycle information?

Click below to explore more details on WIN SOURCE:

-  [View PC81410NSZ on WIN SOURCE](#)
-  [Sharp Microelectronics Information](#)

Optimize Your Supply Chain with WIN SOURCE Solutions

-  Global Sourcing Solution
-  Obsolete Management
-  Cost Control Management
-  Shortage Management
-  Alternative Solution
-  Excess Inventory Management