

**SHARP**  
 OPTO-ANALOG DEVICES DIVISION  
 ELECTRONIC COMPONENTS GROUP  
 SHARP CORPORATION

SPECIFICATION

DEVICE SPECIFICATION FOR

PHOTOCOUPLER

MODEL No. PC123

Business dealing name

	PC123XNYIP0F
	PC123X1YIP0F
	PC123X2YIP0F
	PC123X5YIP0F
	PC123X8YIP0F

Specified for \_\_\_\_\_

Enclosed please find copies of the Specifications which consists of 14 pages including cover.  
 This specification sheets and attached sheets shall be both side copy.  
 After confirmation of the contents, please be sure to send back  copy of the Specifications  
 with approving signature on each.

CUSTOMER'S APPROVAL

PRESENTED

DATE \_\_\_\_\_

DATE Sep. 11, 2007

BY \_\_\_\_\_

BY H. Imanaka

H. Imanaka,  
 Department General Manager of  
 Engineering Dept., II  
 Opto-Analog Devices Div.  
 ELECOM Group  
 SHARP CORPORATION

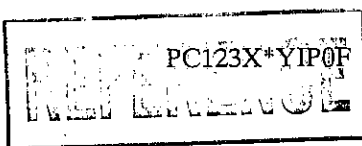

Product name : PHOTOCOUPLER

Model No. : PC123

Business dealing name

PC123XNYIP0F
PC123X1YIP0F
PC123X2YIP0F
PC123X5YIP0F
PC123X8YIP0F

1. These specification sheets include materials protected under copyright of Sharp Corporation ("Sharp"). Please do not reproduce or cause anyone to reproduce them without Sharp's consent.
2. When using this product, please observe the absolute maximum ratings and the instructions for use outlined in these specification sheets, as well as the precautions mentioned below. Sharp assumes no responsibility for any damage resulting from use of the product which does not comply with the absolute maximum ratings and the instructions included in these specification sheets, and the precautions mentioned below.

(Precautions)

- (1) This product is designed for use in the following application areas ;

- OA equipment    Audio visual equipment    · Home appliances
- Telecommunication equipment (Terminal)    · Measuring equipment
- Tooling machines    · Computers

If the use of the product in the above application areas is for equipment listed in paragraphs (2) or (3), please be sure to observe the precautions given in those respective paragraphs.

- (2) Appropriate measures, such as fail-safe design and redundant design considering the safety design of the overall system and equipment, should be taken to ensure reliability and safety when this product is used for equipment which demands high reliability and safety in function and precision, such as ;

- Transportation control and safety equipment (aircraft, train, automobile etc.)
- Traffic signals    · Gas leakage sensor breakers    · Rescue and security equipment
- Other safety equipment

- (3) Please do not use this product for equipment which require extremely high reliability and safety in function and precision, such as ;

- Space equipment    · Telecommunication equipment (for trunk lines)
- Nuclear power control equipment    · Medical equipment

- (4) Please contact and consult with a Sharp sales representative if there are any questions regarding interpretation of the above three paragraphs.

3. Please contact and consult with a Sharp sales representative for any questions about this product.

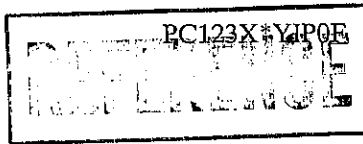

1. Application

This specification applies to the outline and characteristics of photocoupler Model No. PC123(Lead-Free Type).

2. Outline Refer to the attached sheet, page 6.

3. Ratings and characteristics Refer to the attached sheet, page 7, 8.

4. Reliability Refer to the attached sheet, page 9.

5. Outgoing inspection Refer to the attached sheet, page 10.

6. Supplement

6.1 Isolation voltage shall be measured in the following method.

- (1) Short between anode and cathode on the primary side and between collector and emitter on the secondary side.
- (2) The dielectric withstanding tester with zero-cross circuit shall be used.
- (3) The wave form of applied voltage shall be a sine wave.  
(It is recommended that the isolation voltage be measured in insulation oil.)

6.2 Packing specifications Refer to the attached sheet, page 11, 12.

6.3 Collector current (Ic) Delivery rank table ("O" mark indicates business dealing name of ordered product)

Rank at delivery	Business dealing name	Rank mark	Ic (mA)	Test conditions
	PC123XNYIP0F	with or without	2.5 to 20.0	$I_F=5mA$ $V_{CE}=5V$ $T_a=25^{\circ}C$
	PC123X1YIP0F	L	2.5 to 7.5	
	PC123X2YIP0F	M	5.0 to 12.5	
	PC123X5YIP0F	N	10.0 to 20.0	
	PC123X8YIP0F	E	5.0 to 10.0	

6.4 The relevant models are the models Approved by VDE according to DIN EN60747-5-2.

Up to date code "RD" (Decenber2003),the relevant models are approved by VDE according to DIN VDE0884/08.87.

Approved Model No. : PC123

VDE approved No. : 40008087 (According to the specification DIN EN60747-5-2)

- Operating isolation voltage  $U_{FORM}$  : 890V (Peak)
- Transient voltage : 9000V (Peak)
- Pollution : 2
- Clearances distance (Between input and output) : 6.4mm (MIN.)
- Creep age distance (Between input and output) : 6.4mm (MIN.)
- Isolation thickness between input and output : 0.4mm (MIN.)
- Tracking-proof : CTI 175
- Safety limit values
  - Current (I<sub>si</sub>) : 200mA (Diode side)
  - Power (P<sub>si</sub>) : 300mW (Phototransistor side)
  - Temperature (T<sub>si</sub>) : 150°C

In order to keep safety electric isolation of photocoupler, please set the protective circuit to keep within safety limit values when the actual application equipment troubled.

- Indication of VDE approval "  " is printed on minimum unit package.

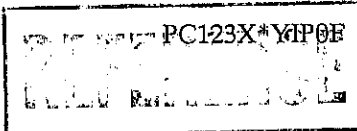

Isolation specification according to EN 60747-5-2

Parameter	Symbol	Condition	Rating	Unit	Remark
Class of environmental test	-	-	55/110/21	-	
Pollution	-	-	2	-	
Maximum operating isolation voltage	$U_{IORM(PEAK)}$	-	890	V	Refer to the Diagram 1,2 (Page 5/12)
Partial discharge test voltage (Between input and output)					
Diagram 1	$U_{Pr(PEAK)}$	$t_p=10s, q_c < 5pC$	1340	V	
Diagram 2		$t_p=1s, q_c < 5pC$	1670	V	
Maximum over-voltage	$U_{IOTM(PEAK)}$	$t_{INT}=60s$	9000	V	
Safety maximum ratings					Refer to Fig. 1,2 (Page 5/12)
1) Case temperature	$T_{si}$	$I_F=0, P_C=0,$	150	°C	
2) Input current	$I_{si}$	$P_C=0$	200	mA	
3) Electric power (Output or Total power dissipation)	$P_{si}$	-	300	mW	
Isolation resistance (Test voltage between input and output ; DC500V)	$R_{ISO}$	$T_a=T_{si}$	MIN.10 <sup>9</sup>	$\Omega$	
		$T_a=T_{opr} (MAX.)$	MIN.10 <sup>11</sup>		
		$T_a=25^\circ C$	MIN.10 <sup>12</sup>		

Precautions in performing isolation test

- (1) Partial discharge test methods shall be the ones according to the specifications of EN 60747-5-2.
- (2) Please don't carry out isolation test ( $V_{iso}$ ) over  $U_{IOTM}$ .  
This product deteriorates isolation characteristics by partial discharge due to applying high voltage (ex.  $U_{IOTM}$ ).  
And there is possibility that partial discharge occurs in operating isolation voltage. ( $U_{IORM}$ ).

6.5 This Model is approved by UL.

Approved Model No. : PC123  
UL file No. : E64380

6.6 This Model is approved by CSA.

Approved Model No. : PC123  
CSA file No. : CA95323

CSA approved mark "  " shall be indicated on minimum unit package.

6.7 This product is approved by BSI. (BS EN60065, BS EN60950)

Approved Model No. : PC123  
Certificate No. : 7087/7409

6.8 This product is approved by SEMKO, DEMKO, NEMKO and FIMKO

6.9 This product is not designed against irradiation.

This product is assembled with electrical input and output.  
This product incorporates non-coherent light emitting diode.

6.10 ODS materials

This product shall not contain the following materials.

Also, the following materials shall not be used in the production process for this product.

Materials for ODS : CFCs, Halon, Carbon tetrachloride, 1,1,1-Trichloroethane (Methyl chloroform)

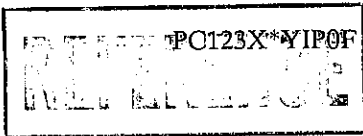

6.11 Specified brominated flame retardants

Specified brominated flame retardants (PBB and PBDE) are not used in this device at all

6.12 Compliance with each regulation

(1) The RoHS directive (2002/95/EC)

This product complies with the RoHS directive (2002/95/EC).

Object substances: mercury, lead, cadmium, hexavalent chromium, polybrominated biphenyls (PBB) and polybrominated diphenyl ethers (PBDE)

(2) Content of six substances specified in Management Methods for Control of Pollution Caused by Electronic Information Products Regulation (Chinese: 电子信息产品污染控制管理办法).

Category	Toxic and hazardous substances					
	Lead (Pb)	Mercury (Hg)	Cadmium (Cd)	Hexavalent chromium (Cr <sup>6+</sup> )	Polybrominated biphenyls (PBB)	Polybrominated diphenyl ethers (PBDE)
Photocoupler	✓	✓	✓	✓	✓	✓

✓: indicates that the content of the toxic and hazardous substance in all the homogeneous materials of the part is below the concentration limit requirement as described in SJ/T 11363-2006 standard.

7. Notes

Precautions for photocouplers : Attachment-1.

Method of Diagram 1: Breakdown test (Apply to tape test and sampling test)

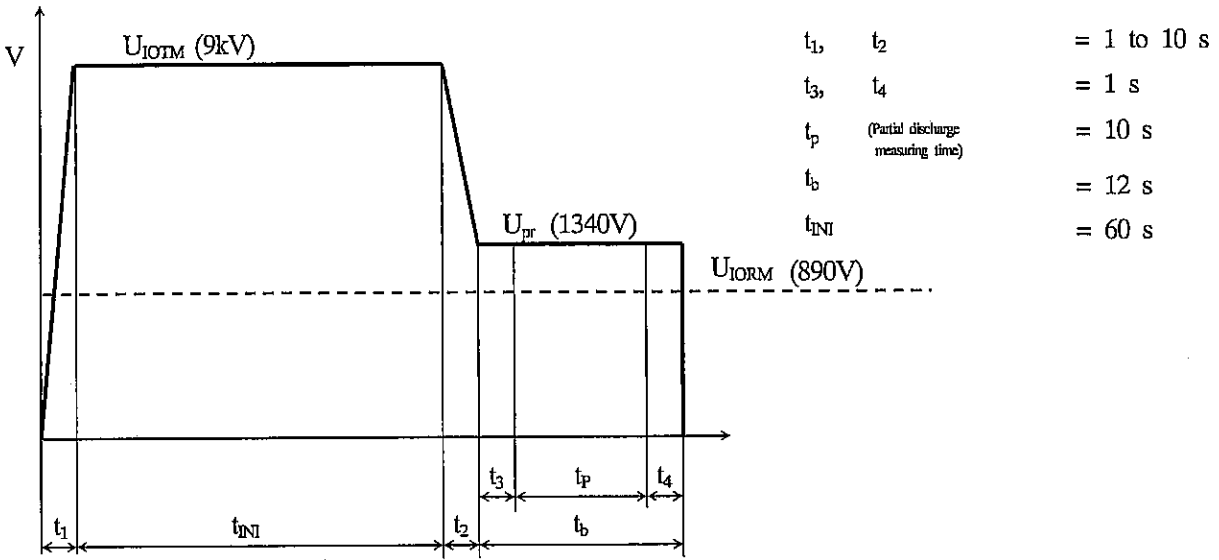

Method of Diagram 2: Non breakdown test (Apply to all device test)

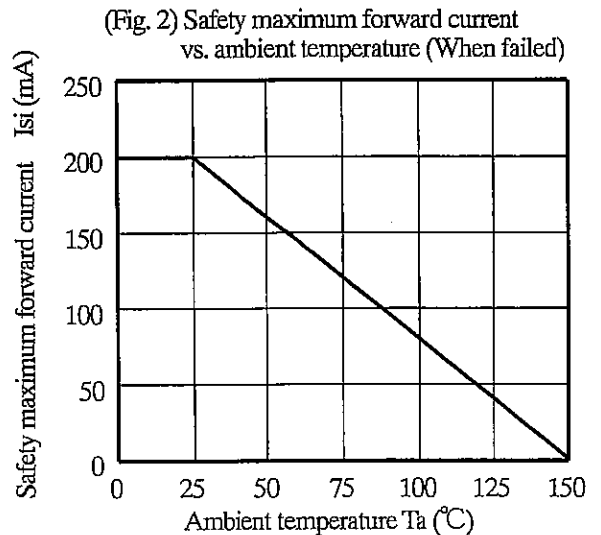
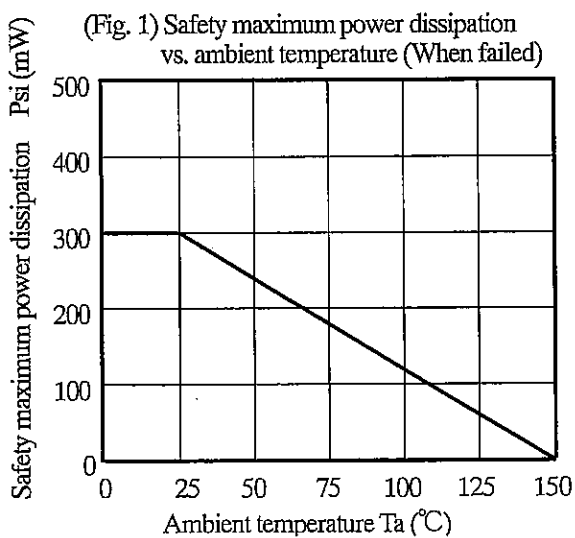
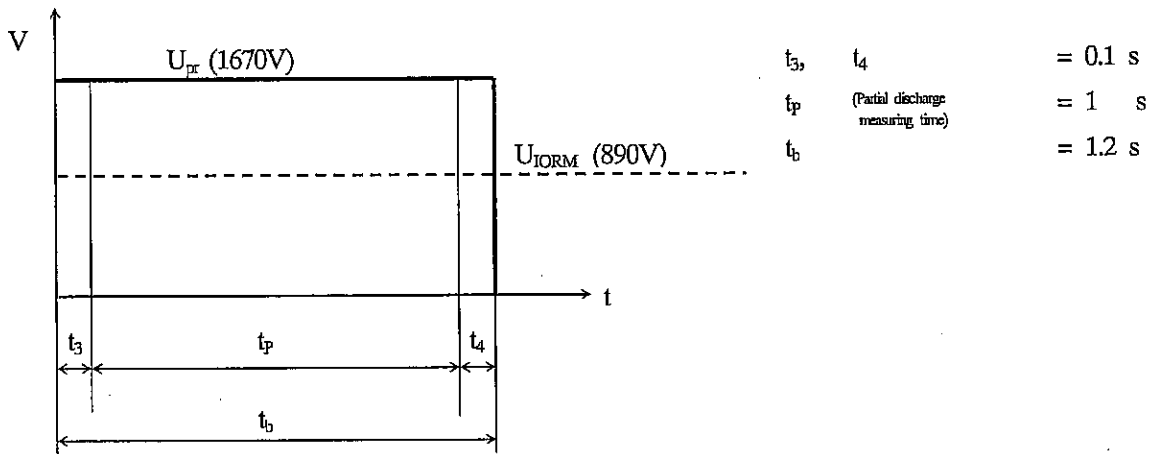

2. Outline

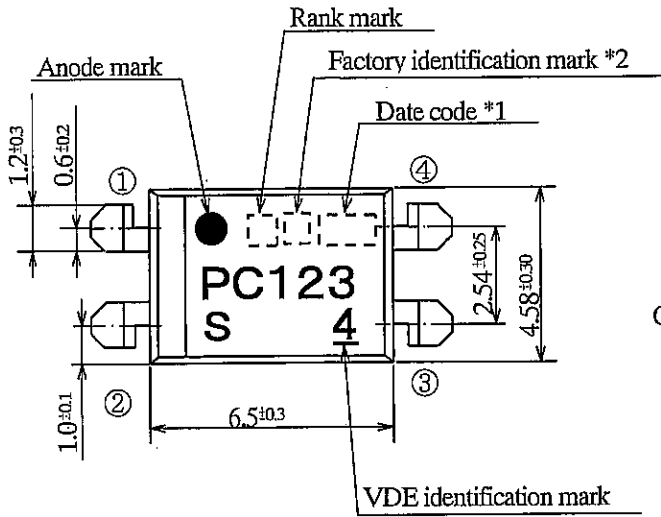

Pin-Number and internal connection diagram

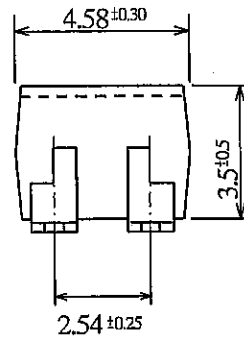
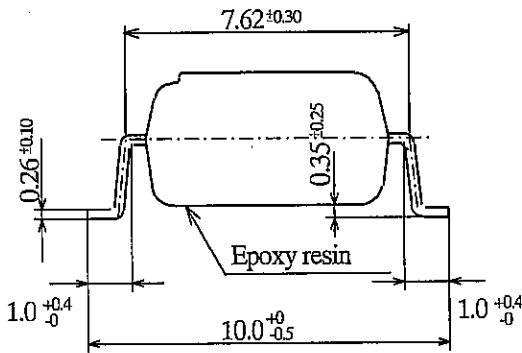
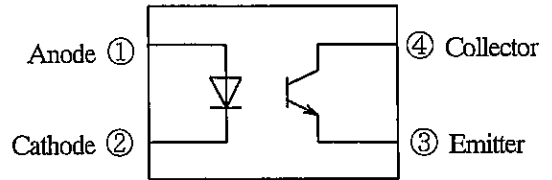

- \*1) 2-digit number shall be marked according to OLD DIN standard.
- \*2) Factory identification mark shall be or shall not be marked.

Without: SUN-S Corporation (Japan)

△ : WUXI WONDERFUL ELECTRONICS CO., LTD. (CHINA)

Pin material : Copper Alloy

Pin finish : SnCu plating (Cu : TYP. 2%)

Product mass : Approx. 0.22 g

Marking is laser marking

UNIT : 1/1 mm	
Name	Outline Dimensions PC123 (Business dealing name : PC123X*YIP0F)

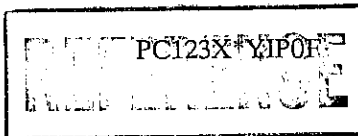

### 3. Ratings and characteristics

#### 3.1 Absolute maximum ratings

Ta=25°C

Parameter		Symbol	Rating	Unit
Input	Forward current *1	$I_F$	50	mA
	Peak forward current *2	$I_{FM}$	1	A
	Reverse voltage	$V_R$	6	V
	Power dissipation *1	P	70	mW
Output	Collector-emitter voltage	$V_{CEO}$	70	V
	Emitter-collector voltage	$V_{ECO}$	6	V
	Collector current	$I_c$	50	mA
	Collector power dissipation *1	$P_c$	150	mW
Total power dissipation *1		$P_{tot}$	200	mW
Operating temperature		$T_{opr}$	-30 to +100	°C
Storage temperature		$T_{stg}$	-55 to +125	°C
Isolation voltage *3		$V_{iso (rms)}$	5	kV
Soldering temperature *4		$T_{sol}$	270	°C

#### 3.2 Electro-optical characteristics

Ta=25°C

Parameter		Symbol	Condition	MIN.	TYP.	MAX.	Unit
Input	Forward voltage	$V_F$	$I_F=20mA$	-	1.2	1.4	V
	Reverse current	$I_R$	$V_R=4V$	-	-	10	$\mu A$
	Terminal capacitance	$C_t$	$V=0, f=1kHz$	-	30	250	pF
Output	Dark current	$I_{CEO}$	$V_{CE}=50V, I_F=0$	-	-	100	nA
	Collector-emitter breakdown voltage	$BV_{CEO}$	$I_c=0.1mA, I_F=0$	70	-	-	V
	Emitter-Collector breakdown voltage	$BV_{ECO}$	$I_E=10 \mu A, I_F=0$	6	-	-	V
Transfer characteristics	Collector current	$I_c$	$I_F=5mA, V_{CE}=5V$	2.5	-	20	mA
	Collector-emitter saturation voltage	$V_{CE(sat)}$	$I_F=20mA, I_c=1mA$	-	0.1	0.2	V
	Isolation resistance	$R_{ISO}$	DC500V 40 to 60%RH	$5 \times 10^{10}$	$10^{11}$	-	$\Omega$
	Floating capacitance	$C_f$	$V=0, f=1MHz$	-	0.6	1.0	pF
	Cut-off frequency	$f_c$	$V_{CE}=5V, I_c=2mA$ $R_L=100 \Omega, -3dB$	-	80	-	kHz
	Response time (Rise)	$t_r$	$V_{CE}=2V, I_c=2mA$ $R_L=100 \Omega$	-	4	18	$\mu s$
	Response time (Fall)	$t_f$		-	3	18	$\mu s$

\*1 The derating factors of absolute maximum ratings due to ambient temperature are shown in Fig. 3 to 6.

\*2 Pulse width  $\leq 100 \mu s$ , Duty ratio : 0.001 (Refer to Fig. 7)

\*3 AC for 1 min, 40 to 60%RH

\*4 For 10s

(Fig.3) Forward current vs. ambient temperature

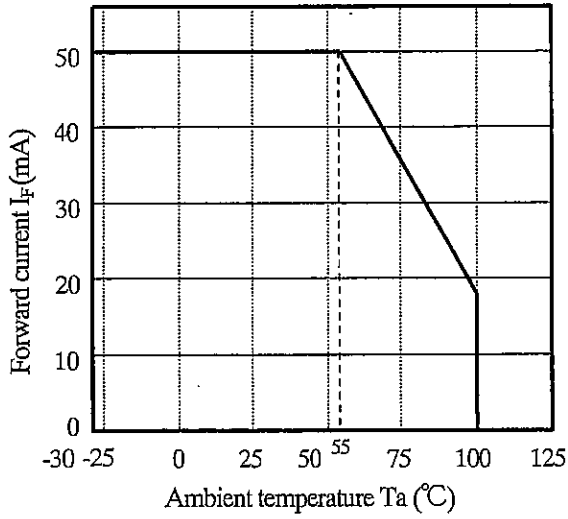

(Fig.4) Diode power dissipation vs. ambient temperature

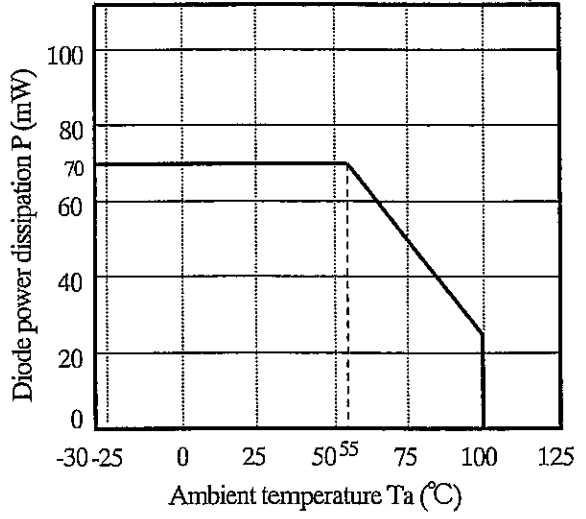

(Fig.5) Collector power dissipation vs. ambient temperature

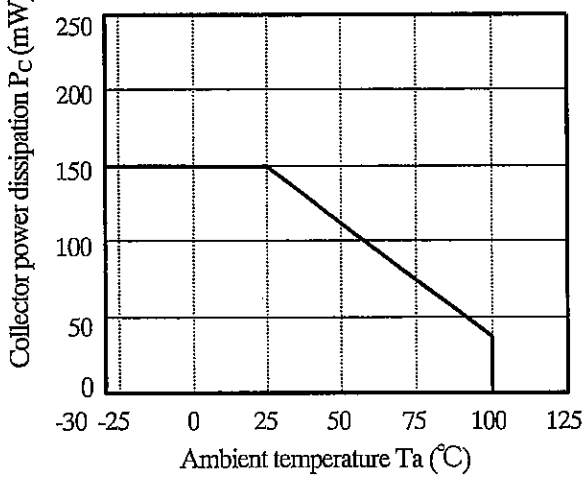

(Fig.6) Total power dissipation vs. ambient temperature

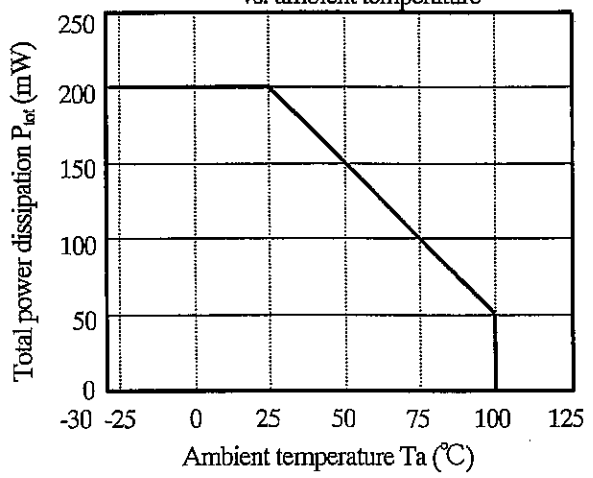

(Fig.7) Peak forward current vs. duty ratio  
 Pulse width  $\leq 100\mu s$   
 $T_a = 25^\circ C$

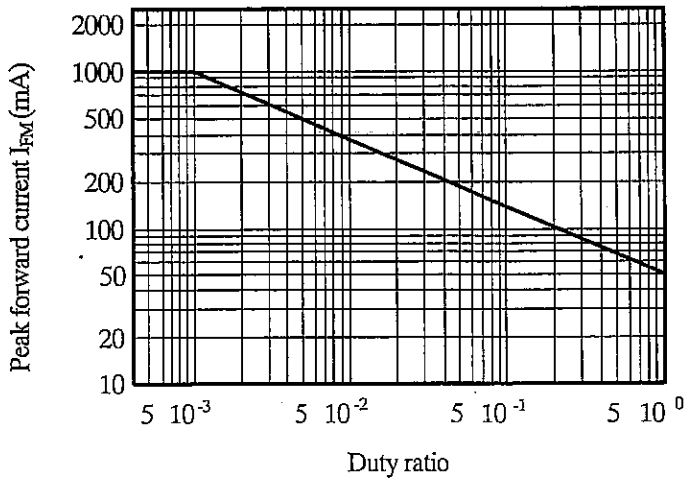

4. Reliability

The reliability of products shall satisfy items listed below.

Confidence level : 90%

LTPD : 10 or 20

Test Items	Condition *1	Failure Judgment Criteria	Samples (n)	
			Defective (C)	
Solderability	245±3°C, 5s	*2	n=11, C=0	
Soldering heat	(Flow soldering) 270°C, 10 s		n=11, C=0	
	(Soldering by hand) 400°C, 3 s			
Terminal strength (Tension)	Weight: 5N 5s / each terminal		n=11, C=0	
Terminal strength (Bending) *3	Weight: 2.5N 2 times / each terminal		n=11, C=0	
Mechanical shock	15km/s <sup>2</sup> , 0.5ms 3 times / ±X, ±Y, ±Z direction		V <sub>F</sub> > U×1.2 I <sub>R</sub> > U×2 I <sub>CEO</sub> > U×2	n=11, C=0
Variable frequency vibration	100 to 2000 to 100Hz / 4min, 200m/s <sup>2</sup> 4 times / X, Y, Z direction		I <sub>C</sub> < L×0.7 V <sub>CE(sat)</sub> > U×1.2	n=11, C=0
Temperature cycling	1 cycle -55°C to +125°C (30 min) (30 min) 20 cycles test		U: Upper specification limit L: Lower specification limit	n=22, C=0
High temp. and high Humidity storage	+85°C, 85%RH, 1000h			n=22, C=0
High temp. storage	+125°C, 1000h			n=22, C=0
Low temp. storage	-55°C, 1000h			n=22, C=0
Operation life	I <sub>F</sub> =50mA, P <sub>tot</sub> =200mW			n=22, C=0
	T <sub>a</sub> =25°C, 1000h			

\*1 Test method, conforms to EIAJ ED 4701.

\*2 Solder shall adhere at the area of 95% or more of immersed portion of lead, and pin hole or other holes shall not be concentrated on one portion.

\*3 Terminal bending direction is shown below.

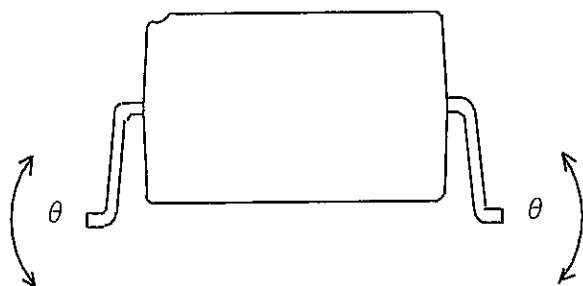

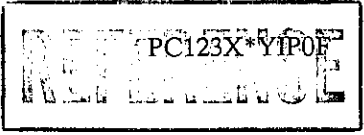

5. Outgoing inspection

5.1 Inspection items

(1) Electrical characteristics

$V_F, I_R, I_{CEO}, V_{CE(sat)}, I_c, R_{ISO}, V_{iso}$

(2) Appearance

5.2 Sampling method and Inspection level

A single sampling plan, normal inspection level II based on ISO 2859 is applied.

The AQL according to the inspection items are shown below.

Defect	Inspection item	AQL (%)
Major defect	Electrical characteristics Unreadable marking	0.065
Minor defect	Appearance defect except the above mentioned.	0.25

6.2 Package specifications

6.2.1 Taping conditions

- (1) Tape structure and Dimensions (Refer to the attached sheet, Page 11)  
The carrier tape has the heat pressed structure of PS material carries tape and three layers cover tape (PET material base).
- (2) Reel structure and Dimensions (Refer to the attached sheet, Page 12)  
The taping reel shall be of plastic (PS material).
- (3) Direction of product insertion (Refer to the attached sheet, Page 12)
- (4) Joint of tape  
The cover tape and carrier tape in one reel shall be joint less.
- (5) To repair failure -taped devices, cutting a bottom of carrier tape with a cutter.  
After replacing the cut portion shall be sealed with adhesive tape.

6.2.2 Adhesiveness of cover tape

The exfoliation force between carrier tape and cover tape shall be 0.2N to 0.7N for the angle 160° to 180° .

6.2.3 Rolling method and quantity

Wind the tape back on the reel so that the cover tape will be outside the tape.  
Attach more than 20cm of blank tape to the trailer and the leader of the tape and fix the both ends with adhesive tape.  
One reel basically shall contain 2000pcs.

6.2.4 Outer packing appearance (Refer to attached sheet, Page 12)

6.2.5 Marking

The label with following information shall be pasted at appointed place of the outer packing case.

- \* Model No. \*(Business dealing name) \* Lot No. \* Quantity
- \* Country of origin \*Company name \*Inspection date specified

6.2.6 Storage condition

Taped products shall be stored at the temperature 5 to 30°C and the humidity 70%RH or less away from direct sunlight.

6.2.7 Safety protection during shipping

There shall be no deformation of component or degradation of electrical characteristics due to shipping.

Carrier tape structure and Dimensions

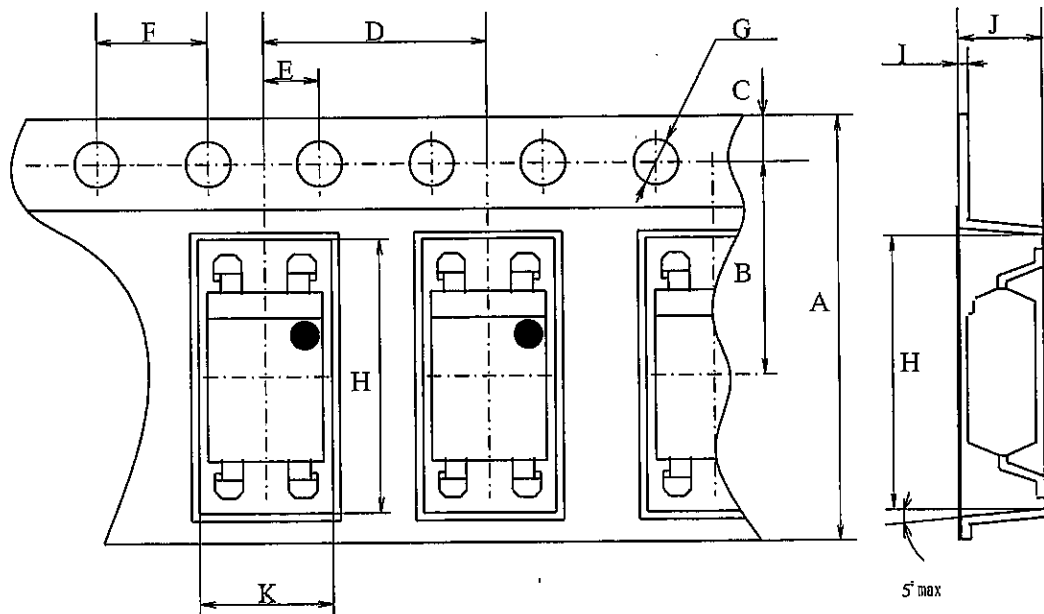

Dimensions list (Unit : mm)

A	B	C	D	E	F	G	H	I	J	K
16.0±0.3	7.5±0.1	1.75±0.10	8.0±0.1	2.0±0.1	4.0±0.1	φ1.5 <sup>+0.1</sup> <sub>0</sub>	10.4±0.1	0.40±0.05	4.2±0.1	5.1±0.1

Reel structure and Dimensions

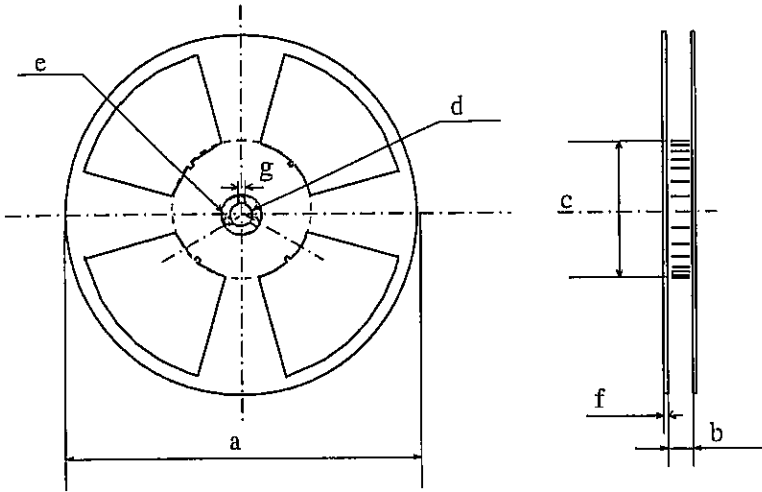

Dimensions list (Unit : mm)

a	b	c	d
(330)	17.5±1.5	φ100.0±1.0	φ13.0±0.5
e	f	g	
φ23.0±1.0	2.0±0.5	2.0±0.5	

Direction of product insertion

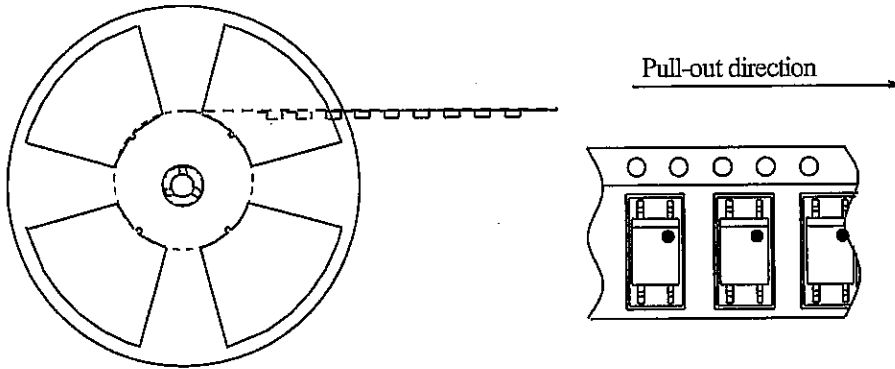

Outer packing appearance

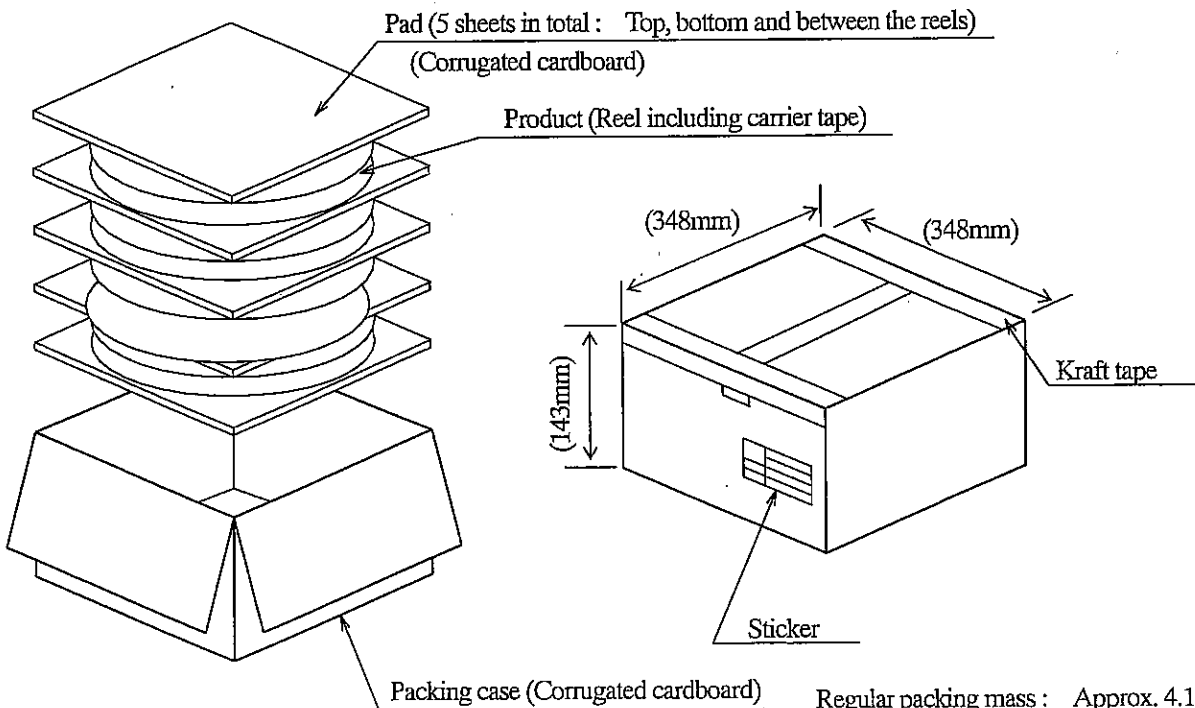

Regular packing mass : Approx. 4.1kg  
 ( ) : Reference dimensions

Precautions for Photocouplers

1. Cleaning

- (1) Solvent cleaning : Solvent temperature 45°C or less  
Immersion for 3 min or less
- (2) Ultrasonic cleaning : The effect to device by ultrasonic cleaning differs by cleaning bath size, ultrasonic power output, cleaning time, PCB size or device mounting condition etc. Please test it in actual using condition and confirm that any defect doesn't occur before starting the ultrasonic cleaning.
- (3) Applicable solvent : Ethyl alcohol, Methyl alcohol, Isopropyl alcohol  
When the other solvent is used, there are cases that the packaging resin is eroded.  
Please use the other solvent after thorough confirmation is performed in actual using condition.

2. Circuit design

- (1) The LED used in the Photocoupler generally decreases the light emission power by operation.  
In case of long operation time, please design the circuit in consideration of the degradation of the light emission power of the LED. (50%/5years)
- (2) There are cases that the deviation of the CTR and the degradation of the relative light emission power of the LED increase when the setting value of  $I_F$  is less than 1.0mA. Please design the circuit in consideration of this point.

3. Precautions for Soldering

- (1) In the case of flow soldering (Whole device dipping .)  
It is recommended that flow soldering should be at 270°C or less for 10 s or less  
(Pre-heating : 100 to 150°C, 30 to 80s, (2 times or less)
- (2) If solder reflow :  
It is recommended to be done at the temperature and the time within the temperature profile as shown in the figure below. (2 times or less)

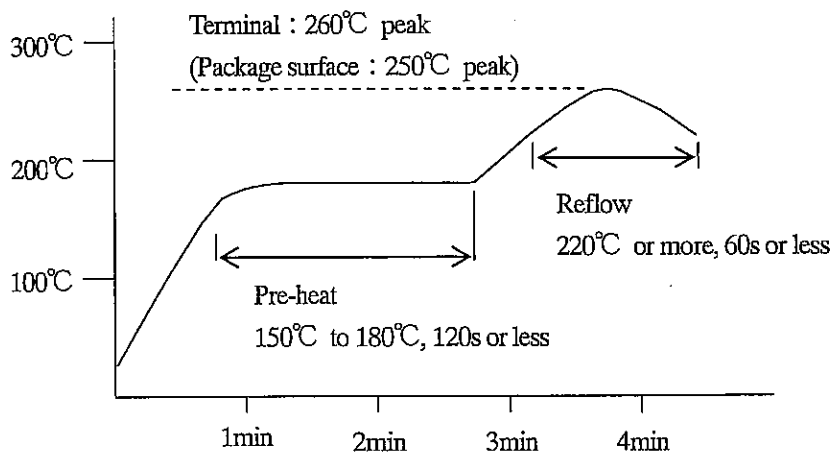

- (3) In the case of hand soldering  
What is done on the following condition is recommended.(2 times or less)  
Soldering iron temperature : 400°C or less  
Time : 3s or less
- (4) Other precautions  
Depending on equipment and soldering conditions (temperature, Using solder etc.), the effect to the device and the PCB is different.  
Please confirm that there is no problem on the actual use conditions in advance.

## Looking for pricing, stock, or lifecycle information?

Click below to explore more details on WIN SOURCE:

- ⊖ [View PC123X2YIP0F on WIN SOURCE](#)
- ⊖ [Sharp Microelectronics Information](#)

## Optimize Your Supply Chain with WIN SOURCE Solutions

- ✓ Global Sourcing Solution
- ✓ Obsolete Management
- ✓ Cost Control Management
- ✓ Shortage Management
- ✓ Alternative Solution
- ✓ Excess Inventory Management