



**THE DATASHEET OF
PAM99700AC**



Description

The PAM99700 is an open-loop current-mode control LED-driver integrated circuit (IC). The PAM99700 can be programmed to operate in either a constant frequency or constant off-time mode. The device includes a 12V to 500V regulator, which allows the device to work from a wide range of input voltages without the requirement for an external low-voltage supply. The PAM99700 includes a pulse-width modulation (PWM) dimming input that can accept an external control signal with a duty ratio of 0% to 100% and a frequency of up to a few kilohertz. The device also includes a 0mV to 250mV linear dimming input, which can be used for linear dimming of the LED current.

The PAM99700 is ideally suited for buck LED drivers. Because the PAM99700 operates in open-loop current-mode control, the controller achieves good output current regulation without the requirement for any loop compensation. PWM dimming response is limited only by the rate of rise and fall of the inductor current, which enables very fast rise and fall times. The PAM99700 requires only three external components (apart from the power stage) to produce a controlled LED current making the device an ideal solution for low-cost LED drivers.

Pin Assignments

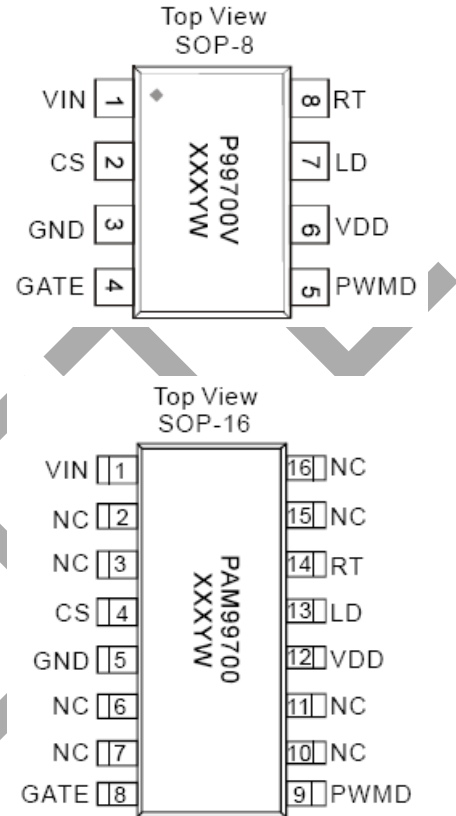

Features

- Switch-Mode Controller for Single-Switch LED Drivers
- Open-Loop Peak-Current Controller
- Constant Frequency or Constant Off-Time Operation
- Linear and PWM Dimming Capability
- Requires Few External Components for Operation
- Application From a Few mA to More than 1A Output

Applications

- DC/DC or AC/DC LED Driver Applications
- RGB Backlighting LED Driver
- Back Lighting of Flat Panel Displays
- General Purpose Constant Current Source
- Signage and Decorative LED Lighting

Typical Applications Circuit

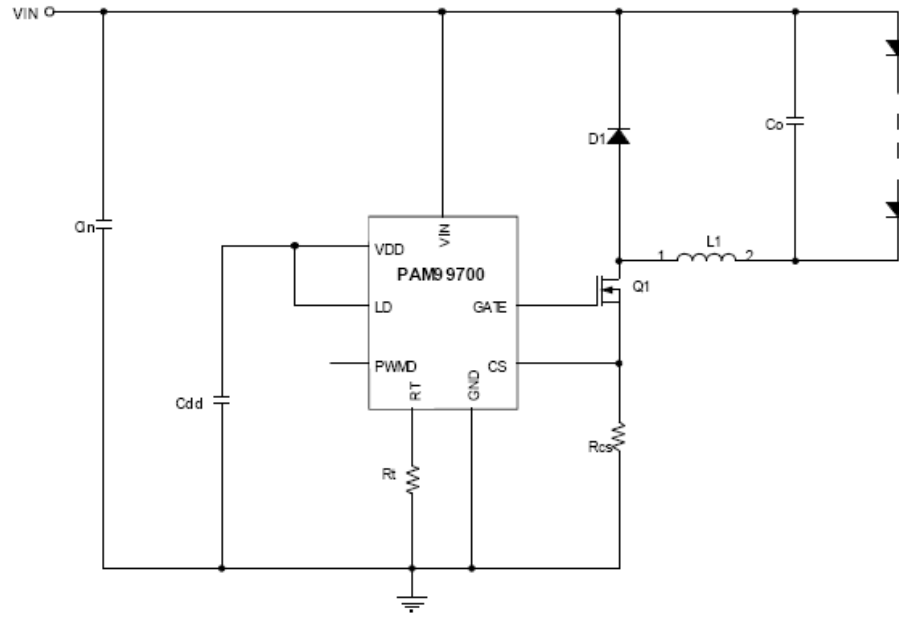

Pin Descriptions

Pin Name	Pin Number		Function
	SOP-8	SOP-16	
VIN	1	1	This pin is the input of a 12V to 500V regulator.
CS	2	4	This pin is the current-sense pin used to sense the FET current by means of an external sense resistor. When this pin exceeds the lower of either the internal 250mV or the voltage at the LD pin, the gate output goes low.
GND	3	5	Ground return for all internal circuitry. This pin must be electrically connected to the ground of the power train.
GATE	4	8	This pin is the output gate driver for an external N-Channel power MOSFET.
PWMD	5	9	This is the PWM dimming input of the IC. When this pin is pulled to GND, the gate driver is turned off. When the pin is pulled high, the gate driver operates normally.
VDD	6	12	This is the power supply pin for all internal circuits. It must be bypassed with a low ESR capacitor to GND (approximately 10µF).
LD	7	13	This pin is the linear dimming input and sets the current sense threshold as long as the voltage at the pin is less than 250mV (typ).
RT	8	14	This pin sets the oscillator frequency. When a resistor is connected between RT and GND, the PAM99700 operates in constant frequency mode. When the resistor is connected between RT and GATE, the IC operates in constant off-time mode.
NC	—	2, 3, 6, 7, 10, 11, 15, 16	Not connected.

OBSOLETE – PART DISCONTINUED

Functional Block Diagram

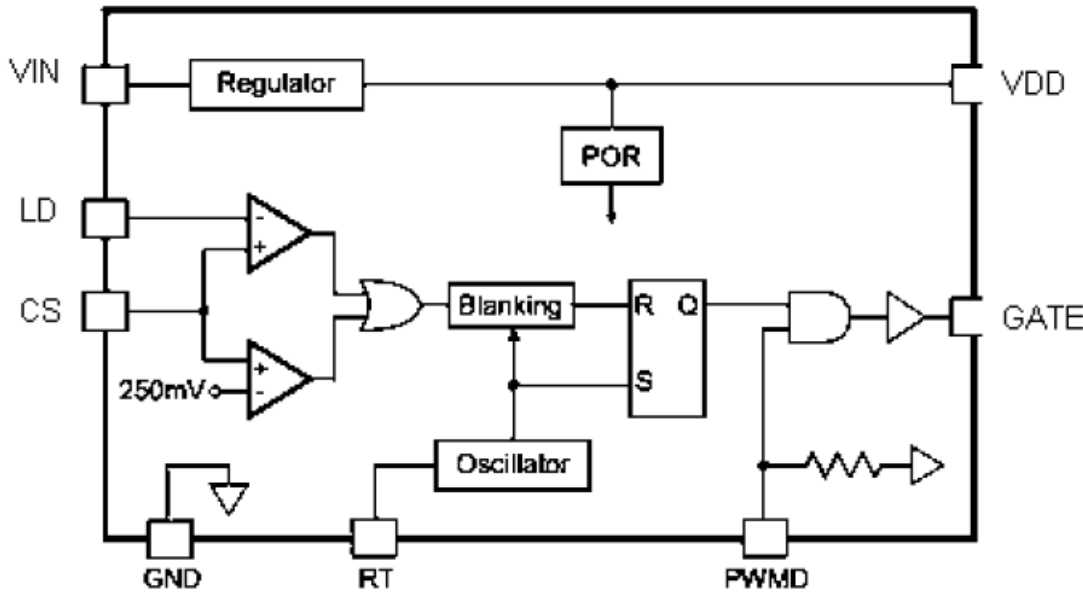

Absolute Maximum Ratings (@T_A = +25°C, unless otherwise specified.)

These are stress ratings only and functional operation is not implied. Exposure to absolute maximum ratings for prolonged time periods can affect device reliability. All voltages are with respect to ground.

Parameter	Rating	Unit
Maximum Junction Temperature	150	°C
Storage Temperature	-65 to +150	
Soldering Temperature	300, 5sec	

Recommended Operating Conditions (@T_A = +25°C, unless otherwise specified.)

Parameter	Rating	Unit
Supply Voltage	12 to 500	V
Ambient Temperature Range	-40 to +85	°C
Junction Temperature Range	-40 to +125	°C

Thermal Information

Parameter	Package	Symbol	Max	Unit
Thermal Resistance (Junction to Ambient)	SOP-8	θ _{JA}	115	°C/W
	SOP-16		110	

Electrical Characteristics (@T_A = +25°C, unless otherwise specified.)

Parameter	Symbol	Test Conditions	Min	Typ	Max	Units
Input Voltage Range	V _{INDC}	DC Input Voltage	12	—	500	V
Shutdown Mode Supply Current	I _{NSD}	Pin PWM to GND	—	0.1	—	mA
Internally Regulated Voltage	V _{DD}	V _{IN} > 20V	6	10	—	V
Current Sense Pull-In Threshold Voltage	V _{CS,TH}	—	—	250	—	mV
Current Sense Blanking Interval	T _{BLANK}	—	—	250	—	Ns
Gate-Sourcing Current	I _{SOURCE}	V _{GATE} = 0V	0.2	—	—	A
Gate-Sinking Current	I _{SINK}	V _{GATE} = V _{DD}	0.2	—	—	A
Gate-Output Rise Time	t _{RISE}	C _{GATE} = 1nF	—	30	50	ns
Gate-Output Fall Time	t _{FALL}	C _{GATE} = 1nF	—	30	50	ns
Oscillator Frequency	f _{OSC}	R _T = 510kΩ	37	41	49	kHz
		R _T = 226kΩ	74	92	110	
EN Threshold High	V _{EH}	V _{IN} = 12V to 500V	2.4	—	—	V
EN Threshold Low	V _{EL}	V _{IN} = 12V to 500V	—	—	1.0	V
Overtemperature Protection (OTP)	OTP	—	—	160	—	°C
OTP Hysteresis	OTH	—	—	50	—	°C

OBSOLETE - PART DISCONTINUED

OBSOLETE

Typical Performance Characteristics

(@T_A = +25°C, V_{IN} = 60V, 1WLED, R_T = 510KΩ, L = 5.2mH, unless otherwise specified.)

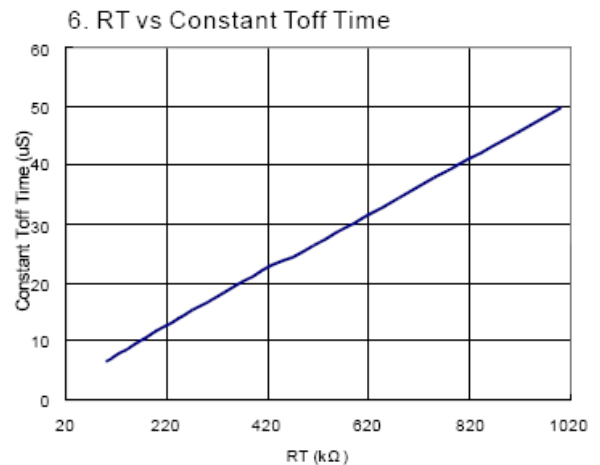
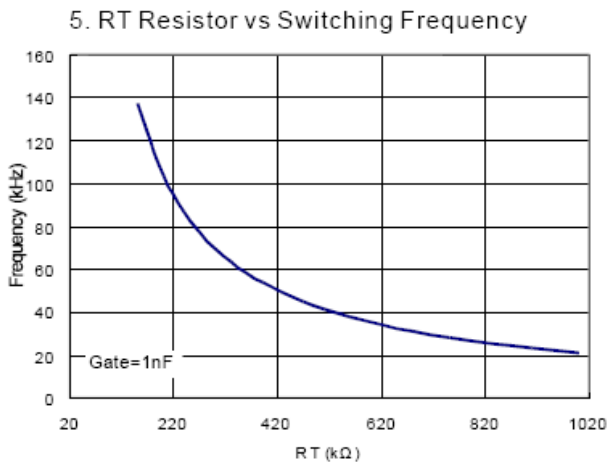
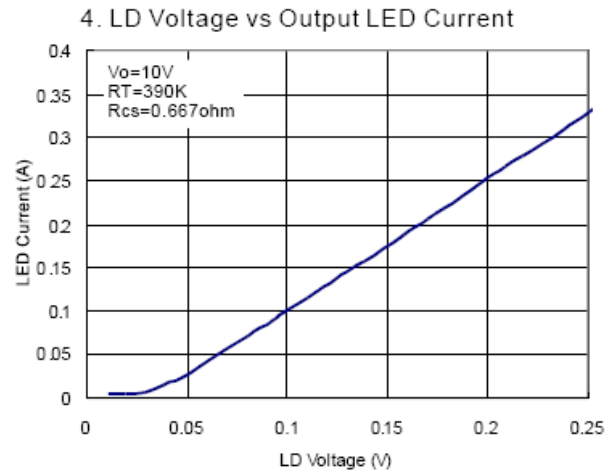
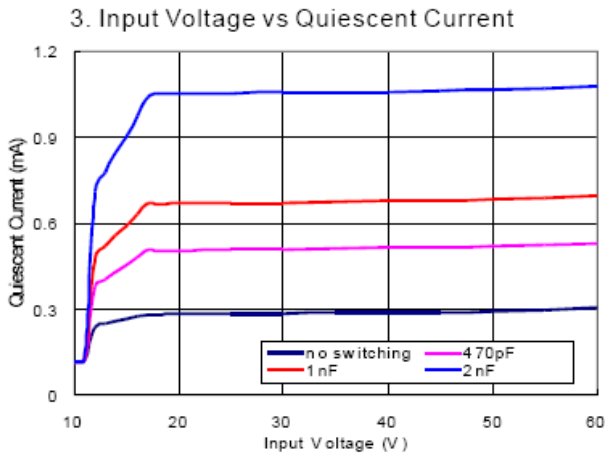
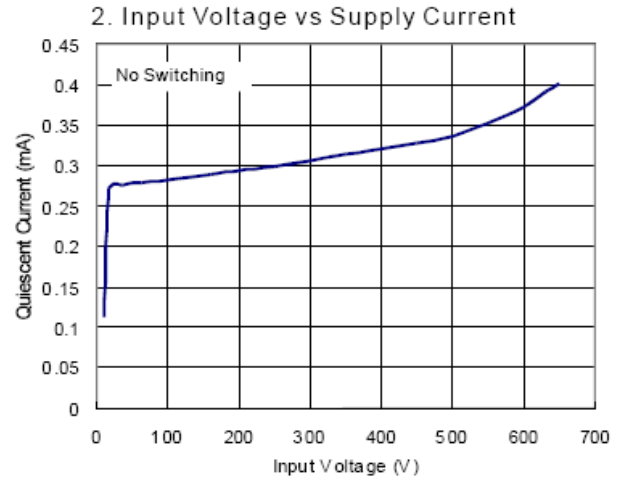
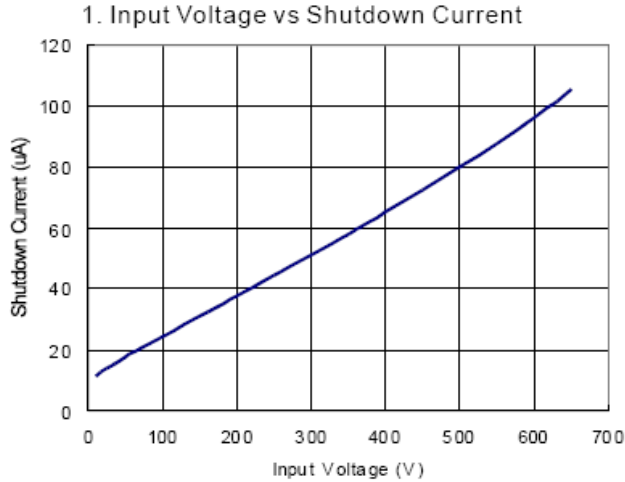

Typical Performance Characteristics (continued)

(@ $T_A = +25^\circ\text{C}$, $V_{IN} = 110\text{V}_{AC}$, 1W_{LED} , $R_T = 510\text{K}\Omega$, $L = 5.2\text{mH}$, $R_{CS} = 0.68\Omega$, unless otherwise specified.)

7. Input Voltage vs Efficiency

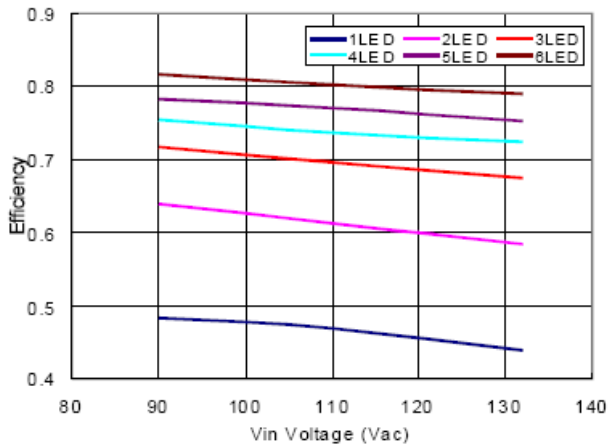

8. Input Voltage vs LED Current

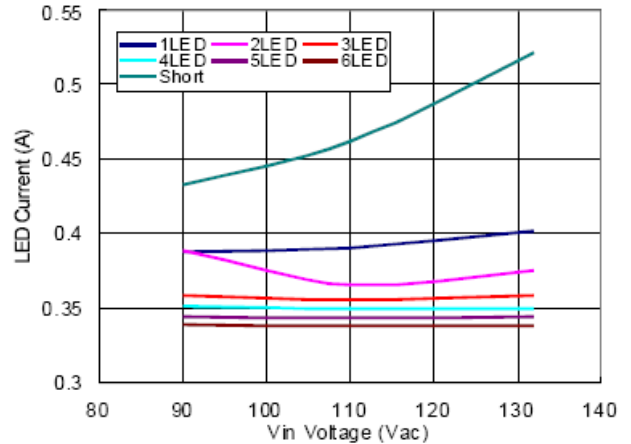

9. Output Voltage vs Efficiency

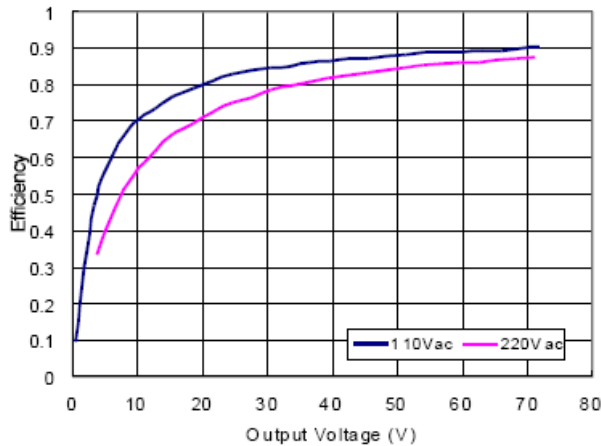

10. Output Voltage vs LED Current

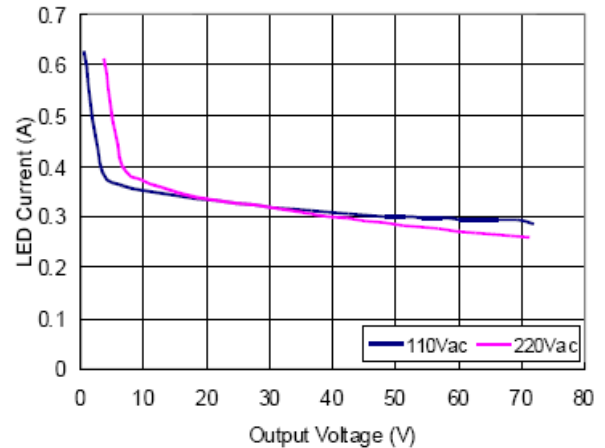

11. PWM Dimming use PWM_D pin

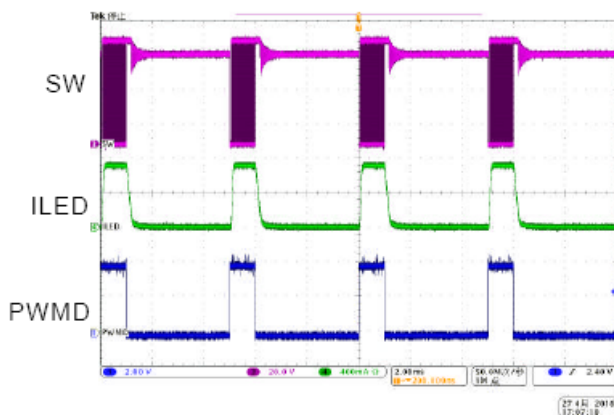

12. PWM Dimming use PWM_D pin

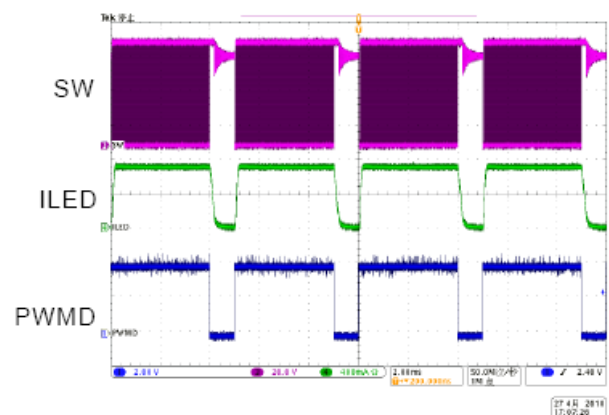

Application Information

The PAM99700 is optimized to drive buck LED drivers using open-loop peak current-mode control. This method of control enables fairly accurate LED current control without the requirement for high-side current sensing or the design of any closed-loop controllers. The IC uses very few external components and enables both linear and PWM dimming of the LED current.

A resistor connected to the RT pin programs the frequency of operation (or the off time). The oscillator produces pulses at regular intervals. These pulses set the SR flip-flop in the PAM99700, which causes the gate driver to turn on. The same pulses also start the blanking timer, which inhibits the reset input of the SR flip-flop and prevents false turnoffs due to the turn-on spike. When the FET turns on, the current through the inductor starts ramping up. This current flows through the external sense resistor R_{CS} and produces a ramp voltage at the CS pin. The comparators are constantly comparing the CS pin voltage to both the voltage at the LD pin and the internal 250mV. Once the blanking timer is complete, the output of these comparators is allowed to reset the flip-flop. When the output of either one of the two comparators goes high, the flip-flop is reset, and the gate output goes low. The gate goes low until the SR flip-flop is set by the oscillator. Assuming a 30% ripple in the inductor, the current sense resistor R_{CS} can be set using the following equation.

$$R_{CS} = 0.25V \text{ (or } V_{LD}) / 1.15 * I_{LED}(A)$$

Constant-frequency peak current-mode control has an inherent disadvantage—at duty cycles greater than 0.5, the control scheme goes into subharmonic oscillations. To prevent this, an artificial slope is typically added to the current-sense waveform. This slope compensation scheme affects the accuracy of the LED current in the present form. However, a constant off-time peak-current control scheme does not have this problem and can easily operate at duty cycles greater than 0.5 and also gives inherent input voltage rejection, which makes the LED current almost insensitive to input-voltage variations. However, this control scheme leads to variable frequency operation, and the frequency range depends greatly on the input- and output-voltage variation. PAM99700 makes it easy to switch between the two modes of operation by changing one connection (see oscillator section).

Input Voltage Regulator

The PAM99700 can be powered directly from its VIN pin and can work from 12V to 500V DC at its VIN pin. When a voltage is applied at the VIN pin, the PAM99700 maintains a constant 12V at the V_{DD} pin. This voltage is used to power the IC and any external resistor dividers required to control the IC. The V_{DD} pin must be bypassed by a low-ESR capacitor to provide a low-impedance path for the high-frequency current of the output-gate driver.

The PAM99700 can also operate by supplying a voltage at the V_{DD} pin greater than the internally regulated voltage. This turns off the internal linear regulator of the IC, and the PAM99700 operates directly off the voltage supplied at the V_{DD} pin. Note this external voltage at the V_{DD} pin must not exceed 15V.

Although the VIN pin of the PAM99700 is rated up to 500V, the actual maximum voltage that can be applied is limited by the power dissipation in the IC. For example, if an 8-pin (junction -to-ambient thermal resistance $R_{\theta J-A} = 115^{\circ}\text{C/W}$) PAM99700 draws about $I_{IN} = 2\text{mA}$ from the VIN pin and has a maximum allowable temperature rise of the junction temperature limited to about $\Delta T = 100^{\circ}\text{C}$, the maximum voltage at the VIN pin would be:

$$\begin{aligned} V_{IN(MAX)} &= \frac{\Delta T}{R_{\theta J-A}} \cdot \frac{1}{I_{IN}} \\ &= \frac{100^{\circ}\text{C}}{115^{\circ}\text{C/W}} \cdot \frac{1}{2\text{mA}} \\ &= 435\text{V} \end{aligned}$$

In these cases, to operate the PAM99700 from higher input voltages, a Zener diode can be added in series with the VIN pin to divert some of the power loss from the PAM99700 to the Zener diode. In the above example, using a 100V zener diode allows the circuit to easily work up to 500V.

The input current drawn from the VIN pin is a sum of the 1.0mA current drawn by the internal circuit and the current drawn by the gate driver, which depends on the switching frequency and the gate charge of the external FET.

$$I_{IN} \approx 350\mu\text{A} + Q_G * f_s$$

In the above equation, f_s is the switching frequency, and Q_G is the gate charge of the external FET, which can be obtained from the datasheet of the FET.

Application Information (continued)

Current Sense

The current-sense input of the PAM99700 goes to the non-inverting inputs of two comparators. The inverting terminal of one comparator is tied to an internal 250mV reference, whereas the inverting terminal of the other comparator is connected to the LD pin. The outputs of both of these comparators are fed into an OR gate, and the output of the OR gate is fed into the reset pin of the flip-flop. Thus, the comparator that has the lowest voltage at the inverting terminal determines when the GATE output is turned off.

The outputs of the comparators also include a 150ns to 280ns blanking time that prevents spurious turnoffs of the external FET due to the turn-on spike normally present in peak current-mode control. In rare cases, this internal blanking might not be enough to filter out the turn-on spike. In these cases, an external RC filter must be added between the external sense resistor (R_{CS}) and the CS pin.

Note the comparators are fast with a typical 80ns response time. Hence these comparators are more susceptible to be triggered by noise than the comparators of the PAM99700. A proper layout minimizing external inductances prevents false triggering of these comparators.

Oscillator

The oscillator in the PAM99700 is controlled by a single resistor connected at the RT pin. The equation governing the oscillator frequency is as follows.

$$F = \frac{21380}{RT(k\Omega) + 5.5} \text{ (kHz)}$$

If the resistor is connected between RT and GND, PAM99700 operates in a constant-frequency mode. The above equation determines the time period. If the resistor is connected between RT and GATE, the PAM99700 operates in a constant off-time mode. The following equation determines the off time.

$$T_{OFF} = \frac{RT(k\Omega) + 44.1}{21.1} \text{ (\mu s)}$$

GATE Output

The gate output of the PAM99700 drives the external FET. It is recommended that the gate charge of the external FET be <25nC for switching frequencies of 100kHz and be <15nC for switching frequencies >100kHz.

Linear Dimming (LD)

The Linear Dimming (LD) pin is used to control the LED current. There are two cases when it may be necessary to use the LD pin. In some cases, it may not be possible to find the exact R_{CS} value required to obtain the LED current when the internal 250mV is used. In these cases, an external voltage divider from the V_{DD} pin can be connected to the LD pin to obtain a voltage (less than 250mV) corresponding to the desired voltage across R_{CS} .

If desired, LD can adjust the current level to reduce the intensity of the LEDs. In these cases, an external 0mV to 250mV can be connected to the LD pin to adjust the LED current during operation. To use the internal 250mV, the LD pin can be connected to V_{DD} .

Note: Although the LD pin can be pulled to GND, the output current will not go to zero. This is due to the presence of a minimum on time (equal to the sum of the blanking time and the delay to output time, which is about 450ns). This will cause the FET to be on for a minimum of 450ns, and thus, the LED current when LD = GND will not be zero. This current is also dependent on the input voltage, inductance value, forward voltage of the LEDs, and circuit parasitics. To get zero LED current, the PWMD pin must be used.

PWM Dimming (PWMD)

PWM Dimming (PWMD) can be achieved by driving the PWMD pin with a low-frequency square-wave signal. When the PWM signal is zero, the gate driver is turned off, and when the PWMD signal is high, the gate driver is enabled. Because the PWMD signal does not turn off the other parts of the IC, the response of the PAM99700 to the PWMD signal is almost instantaneous. The rate of rise and fall of the LED current is thus determined solely by the rise and fall times of the inductor current. To disable PWM dimming and enable the PAM99700 permanently, connect the PWMD pin to V_{DD} .

Thermal Protection

When the die temperature exceeds +160°C, a reset occurs, and the reset remains until the temperature decreases to +110°C at which time the circuit can be restarted. When the die temperature exceeds +160°C, a reset occurs, and the reset remains until the temperature decreases to +110°C at which time the circuit can be restarted.

Ordering Information

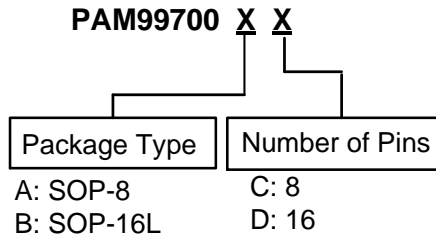

Part Number	Package Type	Standard Package
PAM99700AC	SOP-8L	2500 Units/Tape&Reel
PAM99100BD	SOP-16L	2500 Units/Tape&Reel

Marking Information

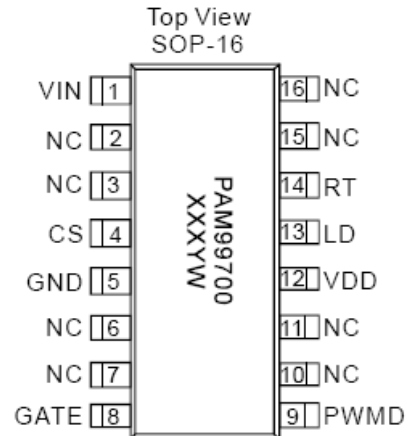
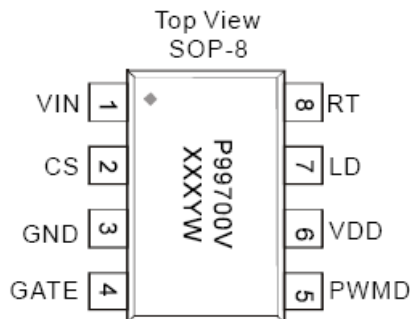

V: Output Voltage
Y: Year
W: Week
X: Internal Code



Package Outline Dimensions (All dimensions in mm)

Please see <http://www.diodes.com/package-outlines.html> for the latest version.

SOP-8

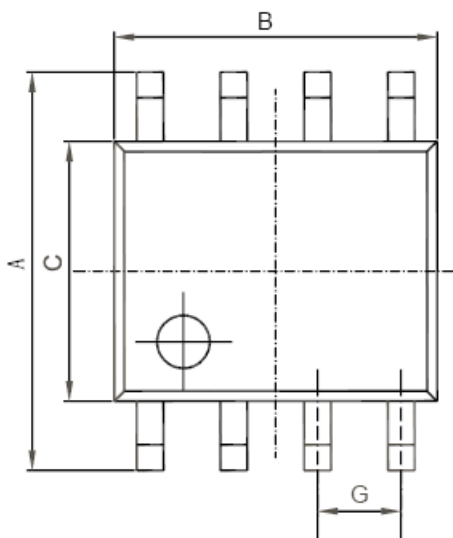

REF	DIMENSIONS	
	Millimeters	
	Min	Max
A	5.80	6.20
B	4.80	5.00
C	3.80	4.00
D	0°	8°
E	0.40	0.90
F	0.19	0.25
M	0.10	0.25
H	0.35	0.49
L	1.35	1.75
J	0.375 REF	
K	45°	
G	1.27 TYP	

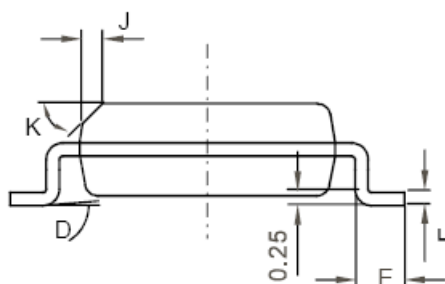
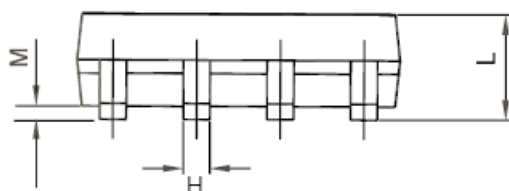

OE

OBSOLETE - PART DISCONTINUED

Package Outline Dimensions (continued) (All dimensions in mm)

Please see <http://www.diodes.com/package-outlines.html> for the latest version

SOP-16

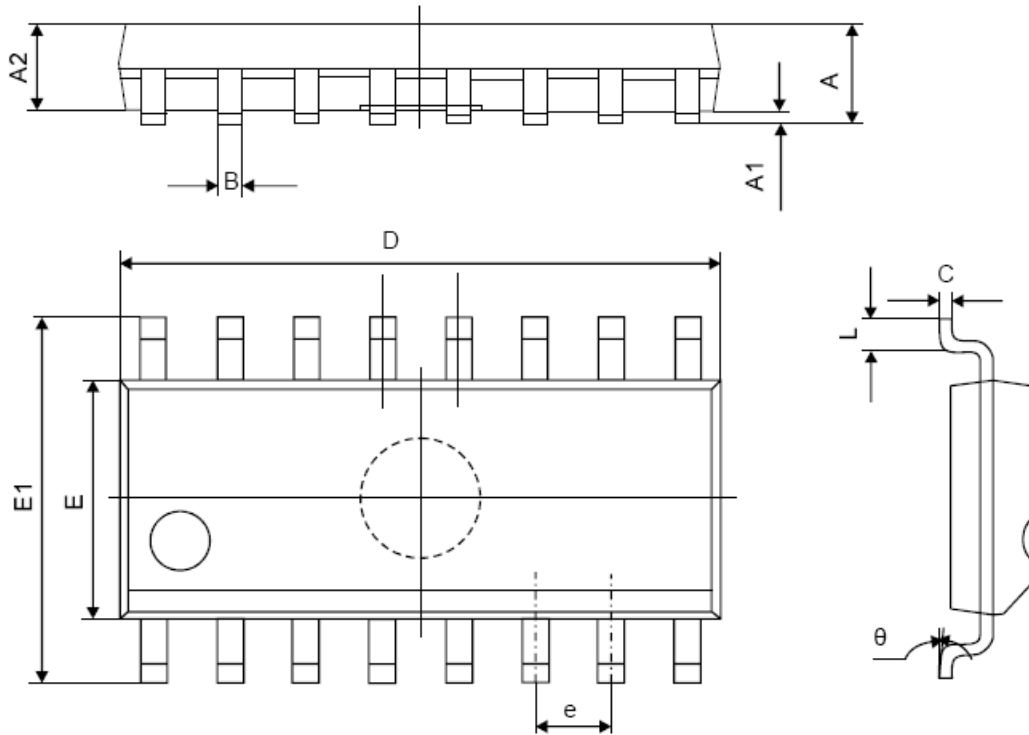

Symbol	Dimensions Millimeters	
	Min	Max
A	1.350	1.750
A1	0.100	0.250
A2	1.350	1.550
B	0.330	0.510
C	0.190	0.250
D	9.800	10.000
E	3.800	4.000
E1	5.800	6.300
e	1.270(TYP)	
L	0.400	1.270
θ	0°	8°

OBSOLETE - PART DISCONTINUED

IMPORTANT NOTICE

DIODES INCORPORATED MAKES NO WARRANTY OF ANY KIND, EXPRESS OR IMPLIED, WITH REGARDS TO THIS DOCUMENT, INCLUDING, BUT NOT LIMITED TO, THE IMPLIED WARRANTIES OF MERCHANTABILITY AND FITNESS FOR A PARTICULAR PURPOSE (AND THEIR EQUIVALENTS UNDER THE LAWS OF ANY JURISDICTION).

Diodes Incorporated and its subsidiaries reserve the right to make modifications, enhancements, improvements, corrections or other changes without further notice to this document and any product described herein. Diodes Incorporated does not assume any liability arising out of the application or use of this document or any product described herein; neither does Diodes Incorporated convey any license under its patent or trademark rights, nor the rights of others. Any Customer or user of this document or products described herein in such applications shall assume all risks of such use and will agree to hold Diodes Incorporated and all the companies whose products are represented on Diodes Incorporated website, harmless against all damages.

Diodes Incorporated does not warrant or accept any liability whatsoever in respect of any products purchased through unauthorized sales channel. Should Customers purchase or use Diodes Incorporated products for any unintended or unauthorized application, Customers shall indemnify and hold Diodes Incorporated and its representatives harmless against all claims, damages, expenses, and attorney fees arising out of, directly or indirectly, any claim of personal injury or death associated with such unintended or unauthorized application.

Products described herein may be covered by one or more United States, international or foreign patents pending. Product names and markings noted herein may also be covered by one or more United States, international or foreign trademarks.

This document is written in English but may be translated into multiple languages for reference. Only the English version of this document is the final and determinative format released by Diodes Incorporated.

LIFE SUPPORT

Diodes Incorporated products are specifically not authorized for use as critical components in life support devices or systems without the express written approval of the Chief Executive Officer of Diodes Incorporated. As used herein:

A. Life support devices or systems are devices or systems which:

1. are intended to implant into the body, or
2. support or sustain life and whose failure to perform when properly used in accordance with instructions for use provided in the labeling can be reasonably expected to result in significant injury to the user.

B. A critical component is any component in a life support device or system whose failure to perform can be reasonably expected to cause the failure of the life support device or to affect its safety or effectiveness.

Customers represent that they have all necessary expertise in the safety and regulatory ramifications of their life support devices or systems, and acknowledge and agree that they are solely responsible for all legal, regulatory and safety-related requirements concerning their products and any use of Diodes Incorporated products in such safety-critical, life support devices or systems, notwithstanding any devices- or systems-related information or support that may be provided by Diodes Incorporated. Further, Customers must fully indemnify Diodes Incorporated and its representatives against any damages arising out of the use of Diodes Incorporated products in such safety-critical, life support devices or systems.

Copyright © 2018, Diodes Incorporated

www.diodes.com

Looking for pricing, stock, or lifecycle information?

Click below to explore more details on WIN SOURCE:

 [View PAM99700AC on WIN SOURCE](#)

 [Diodes Incorporated Information](#)

Optimize Your Supply Chain with WIN SOURCE Solutions

-  Global Sourcing Solution
-  Obsolete Management
-  Cost Control Management
-  Shortage Management
-  Alternative Solution
-  Excess Inventory Management