



THE DATASHEET OF PAM8603MNHR



3W FILTERLESS STEREO CLASS-D AUDIO AMPLIFIER WITH DC VOLUME CONTROL

Description

The PAM8603M is a 3W, stereo, Class-D audio amplifier with DC volume control. It offers low THD+N, allowing it to produce high-quality sound reproduction. The new filterless architecture allows the device to drive the speaker directly, requiring no low-pass output filters, which saves the system cost and PCB area.

With the same numbers of external components, the efficiency of the PAM8603M is much better than class-AB cousins. It can extend the battery life thus ideal for portable applications.

The PAM8603M is available in SSOP-24 and SOP-18 packages.

Features

- 3W Output at 10% THD with a 4Ω Load and 5V Power Supply
- Filterless, Low Quiescent Current and Low EMI
- Low THD+N
- 64-Step DC Volume Control from -75dB to +24dB
- Superior Low Noise
- Efficiency up to 89%
- Short Circuit Protection
- Thermal Shutdown
- Few External Components to Save the Space and Cost
- Pb-Free Package

Applications

- LCD Monitors/TV Projectors
- Notebook Computers
- Portable Speakers
- Portable DVD Players, Game Machines
- Cellular Phones/Speaker Phones

Pin Assignments

**Top View
SSOP-24**

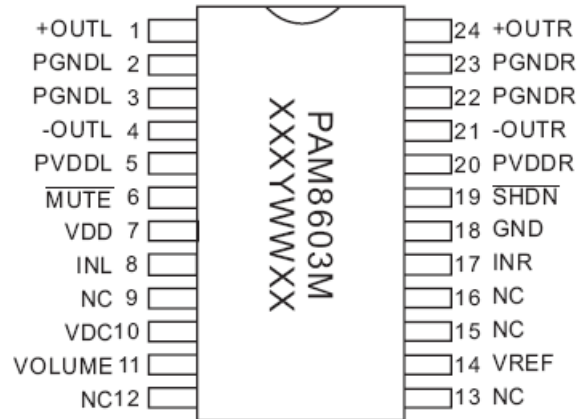

**Top View
SOP-18**

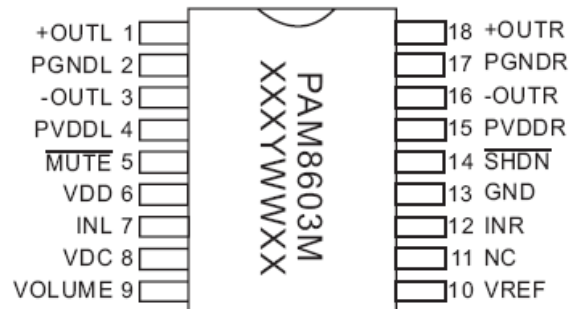

Functional Block Diagram

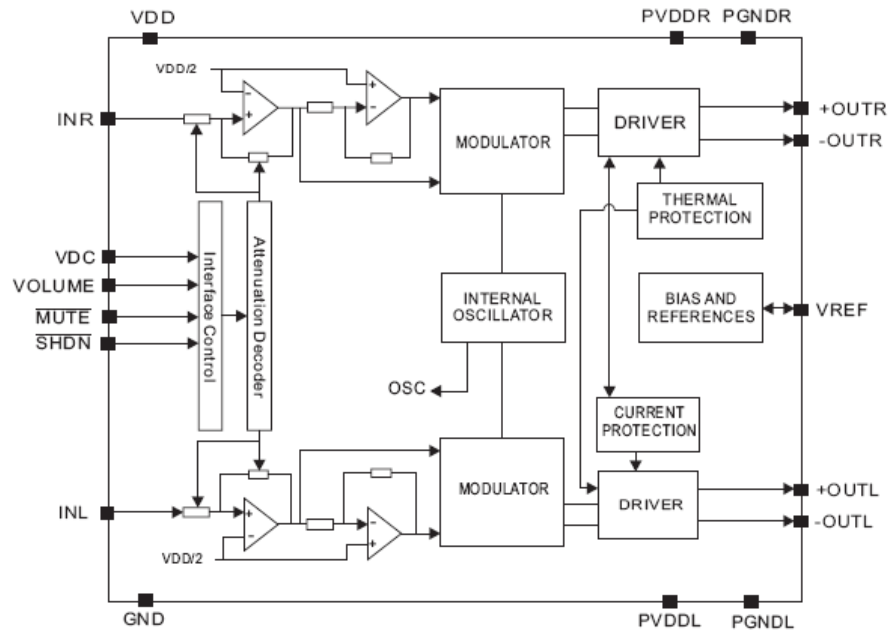

Absolute Maximum Ratings (@T_A = +25°C, unless otherwise specified.)

These are stress ratings only and functional operation is not implied. Exposure to absolute maximum ratings for prolonged time periods may affect device reliability. All voltages are with respect to ground.

Parameter	Rating	Unit
Supply Voltage	6.0	V
Input Voltage	-0.3 to V _{DD} +0.3	
Maximum Junction Temperature	150	°C
Storage Temperature	-65 to +150	
Soldering Temperature	300, 5sec	

Recommended Operating Conditions (@T_A = +25°C, unless otherwise specified.)

Parameter	Rating	Unit
Supply Voltage Range	2.8 to 5.5	V
Ambient Temperature Range	-40 to +85	°C
Junction Temperature Range	-40 to +125	°C

Thermal Information

Parameter	Package	Symbol	Max	Unit
Thermal Resistance (Junction to Ambient)	SSOP-24	θ _{JA}	96	°C/W
	SOP-18		70	
Thermal Resistance (Junction to Case)	SSOP-24	θ _{JC}	18	
	SOP-18		16	

Electrical Characteristics (@T_A = +25°C, V_{DD} = 5V, Gain = 20dB, unless otherwise specified.)

Symbol	Parameter	Test Conditions	Min	Typ	Max	Units	
V _{DD}	Supply Power		2.8		5.5	V	
P _O	Output Power	THD+N = 10%, f = 1kHz, R _L = 4Ω	V _{DD} = 5.0V	2.85	3.2		W
			V _{DD} = 3.6V	1.55	1.8		
		THD+N = 1%, f = 1kHz, R _L = 4Ω	V _{DD} = 5.0V	2.35	2.6		W
			V _{DD} = 3.6V	1.25	1.5		
		THD+N = 10%, f = 1kHz, R _L = 8Ω	V _{DD} = 5.0V	1.55	1.8		W
			V _{DD} = 3.6V	0.75	0.9		
		THD+N = 1%, f = 1kHz, R _L = 8Ω	V _{DD} = 5.0V	1.15	1.4		W
			V _{DD} = 3.6V	0.5	0.72		
THD+N	Total Harmonic Distortion Plus Noise	V _{DD} = 5.0V, P _O = 0.5W, R _L = 8Ω	f = 1kHz		0.15	0.3	%
				V _{DD} = 3.6V, P _O = 0.5W, R _L = 8Ω		0.11	
		V _{DD} = 5.0V, P _O = 1W, R _L = 4Ω	f = 1kHz		0.15	0.3	%
				V _{DD} = 3.6V, P _O = 1W, R _L = 4Ω		0.11	
PSRR	Power Supply Ripple Rejection	V _{DD} = 5.0V, Inputs AC-Grounded	f = 100Hz		-59	-50	dB
			f = 1kHz		-58	-50	
C _S	Crosstalk	V _{DD} = 5.0V, P _O = 0.5W, R _L = 8Ω, f = 1kHz		-58		dB	
SNR	Signal-to-Noise	V _{DD} = 5V, V _{O,RMS} = 1V, f = 1kHz	85	-95	-80	dB	
V _N	Output Noise	V _{DD} = 5V, Inputs AC-Grounded with C _{IN} = 0.47μF	A-weighting		98	150	μV
			No A-weighting		120	300	
Dyn	Dynamic Range	V _{DD} = 5V, THD = 1%, f = 1kHz	90	102		dB	
η	Efficiency	R _L = 8Ω, THD = 10%	f = 1kHz		85	89	%
		R _L = 4Ω, THD = 10%			80	85	
I _Q	Quiescent Current	V _{DD} = 5.0V	No load		13.5	20	mA
		V _{DD} = 3.6V			8.5	15	
I _{MUTE}	Muting Current	V _{DD} = 5.0V, V _{MUTE} = 0.3V		2.7	5	mA	
I _{SD}	Shutdown Current	V _{DD} = 2.5V to 5.5V, V _{SD} = 0.3V			1	μA	
R _{DS(ON)}	Static Drain-to-Source On-State Resistor	I _{DS} = 500mA, V _{GS} = 5V	PMOS		240	500	mΩ
			NMOS		180	350	
f _{sw}	Switching Frequency	V _{DD} = 3V to 5V	200	260	300	kHz	
V _{OS}	Output Offset Voltage	V _{IN} = 0V, V _{DD} = 5V		10	50	mV	
V _{IH}	SD/MUTE Input High	V _{DD} = 5V		1.45		V	
V _{VIL}	SD/MUTE Input Low	V _{DD} = 5V		0.65			
OTP	Over Temperature Protection	No Load, Junction Temperature, V _{DD} = 5V		135		°C	
OTH	Over Temperature Hysteresis			30			

Typical Performance Characteristics (@T_A = +25°C, unless otherwise specified.)

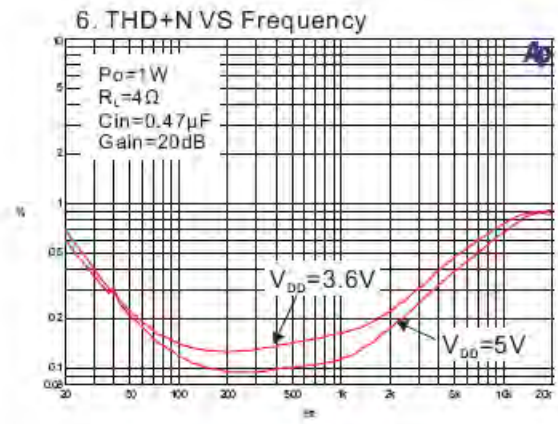
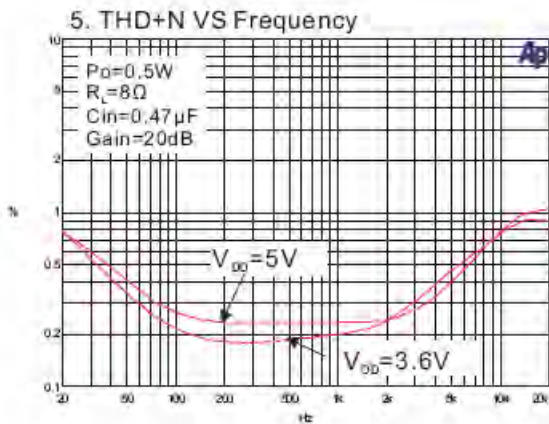
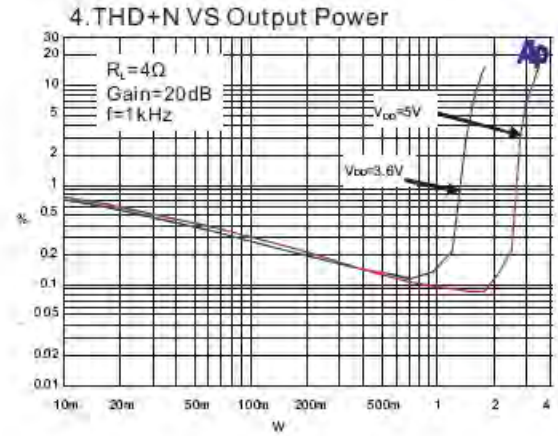
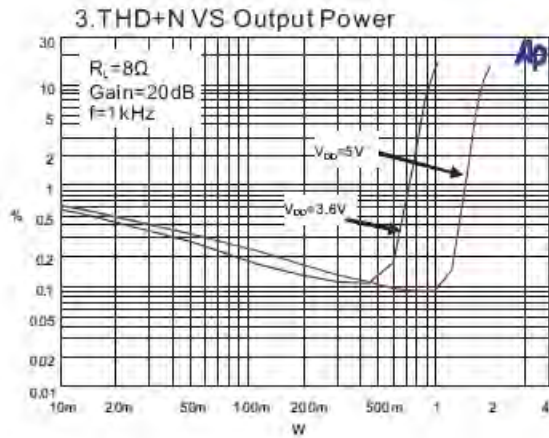
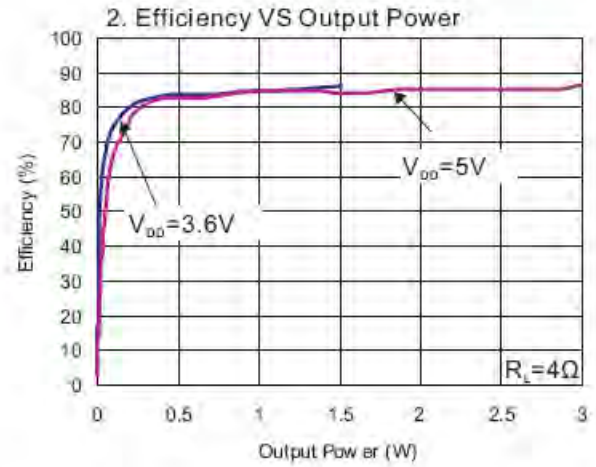
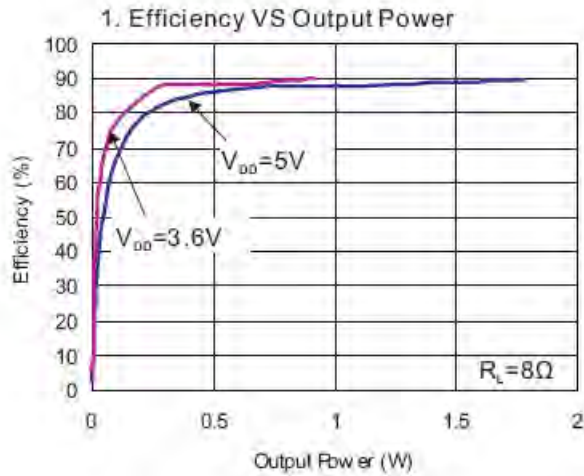

Typical Performance Characteristics (cont.) (@T_A = +25°C, unless otherwise specified.)

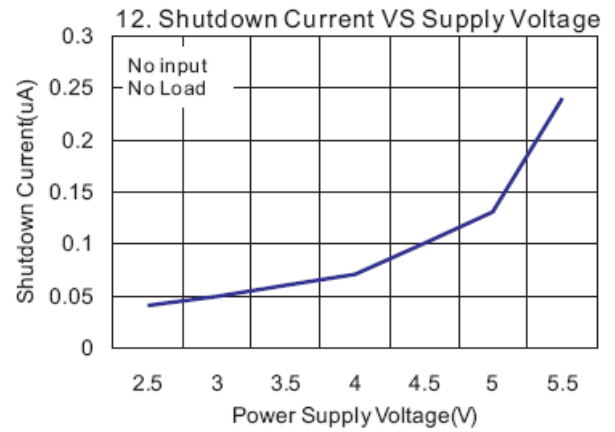
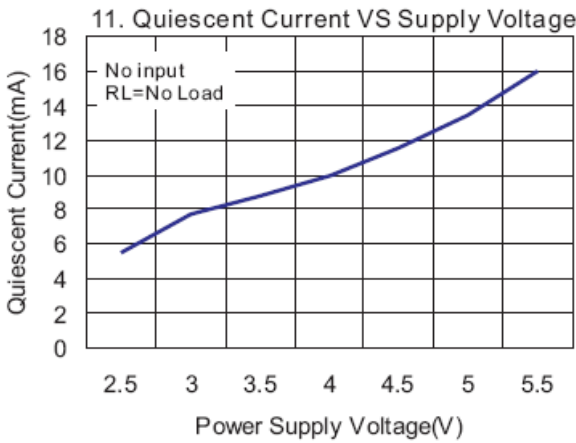
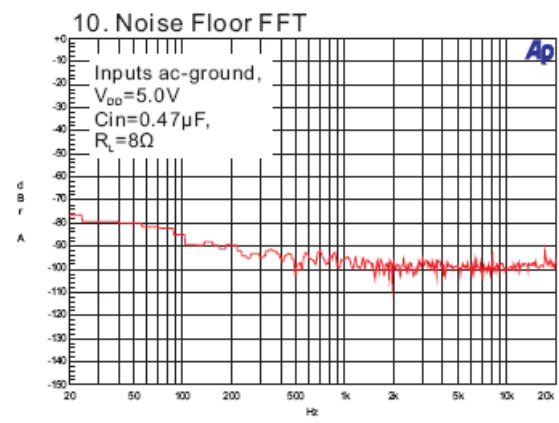
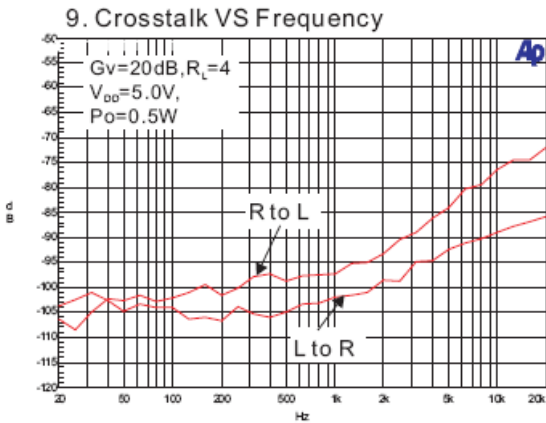
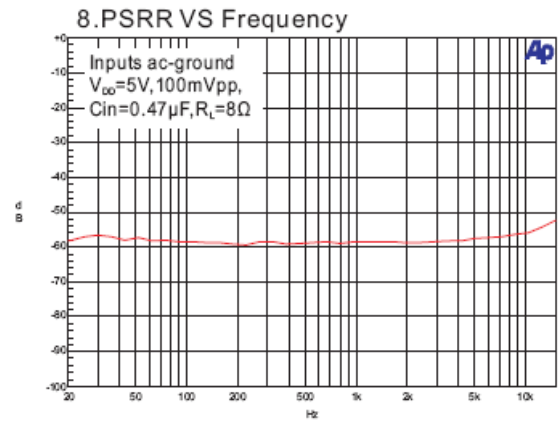
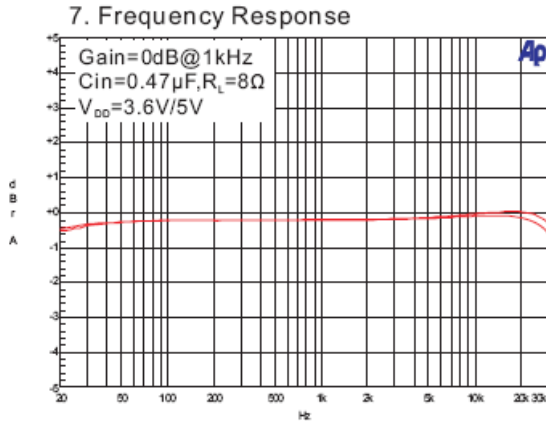

Typical Performance Characteristics (cont.) (@T_A = +25°C, unless otherwise specified.)

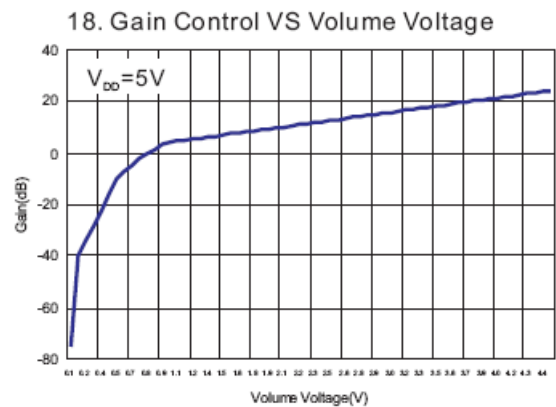
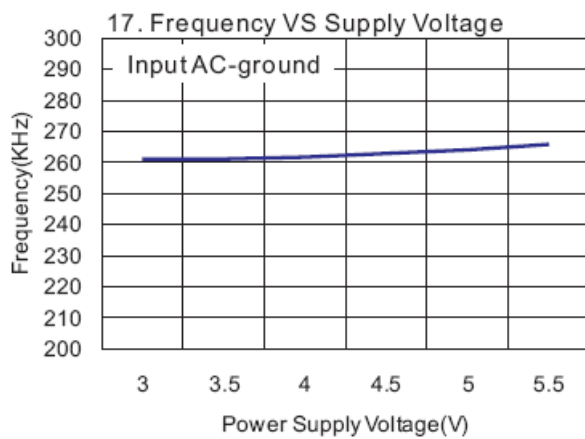
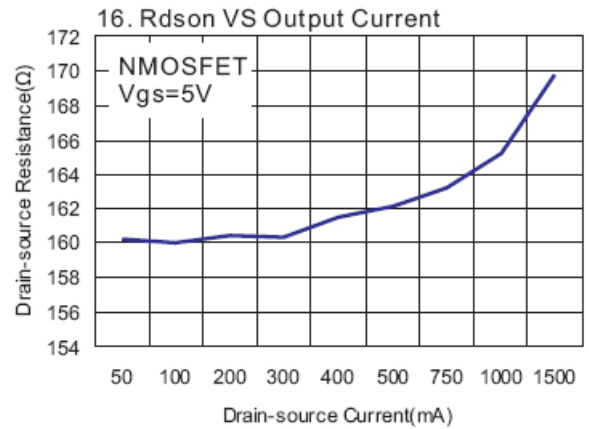
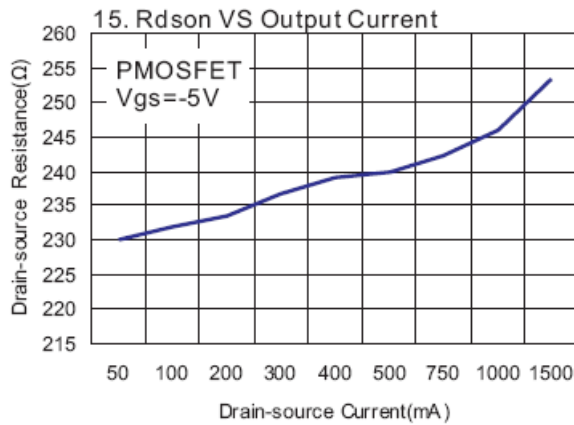
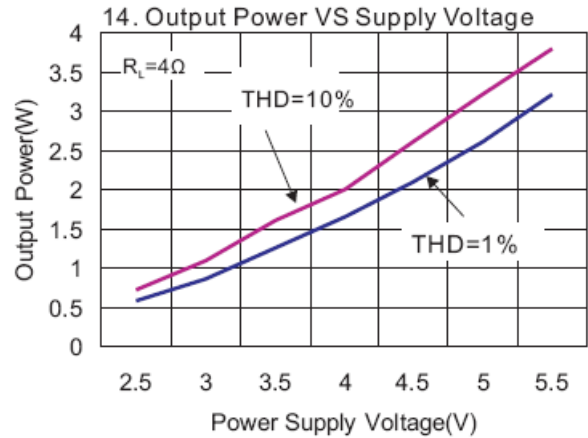
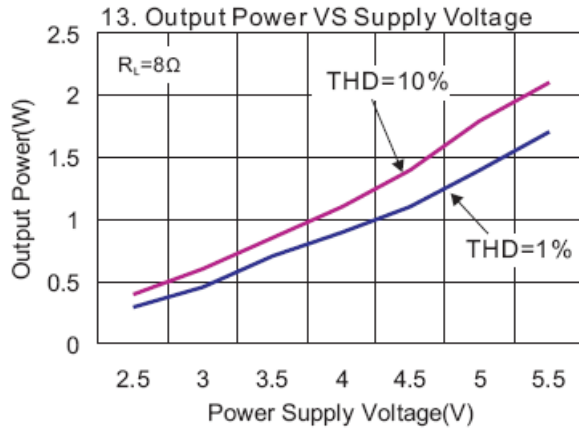

Table 1. DC Volume Control

Step	Gain (dB)	Step	Gain (dB)
0	-75	32	11.6
1	-40	33	12.0
2	-34	34	12.4
3	-28	35	12.8
4	-22	36	13.2
5	-16	37	13.6
6	-10	38	14.0
7	-7.5	39	14.4
8	-5.0	40	14.8
9	-2.5	41	15.2
10	0	42	15.6
11	1.5	43	16.0
12	3.0	44	16.4
13	4.0	45	16.8
14	4.4	46	17.2
15	4.8	47	17.6
16	5.2	48	18.0
17	5.6	49	18.4
18	6.0	50	18.8
19	6.4	51	19.2
20	6.8	52	19.6
21	7.2	53	20.0
22	7.6	54	20.4
23	8.0	55	20.8
24	8.4	56	21.2
25	8.8	57	21.6
26	9.2	58	22.0
27	9.6	59	22.4
28	10.0	60	22.8
29	10.4	61	23.2
30	10.8	62	23.6
31	11.2	63	24.0

Application Information

1. When the PAM8603M works with LC filters, it should be connected with the speaker before it is powered on, otherwise it will be damaged easily.
2. When the PAM8603M works without LC filters, it's better to add a ferrite chip bead at the outgoing line of speaker to suppress the possible electromagnetic interference.
3. The input signal should not be too high. If too high, it will cause the clipping of output signal when increasing the volume. Because the DC volume control of the PAM8603M has big gain, it will make the device damaged.
4. When testing the PAM8603M without LC filters by using resistor instead of speaker as the output load, the test results, e.g. efficiency, will be worse than those using speaker as load.

Test Setup for Performance Testing

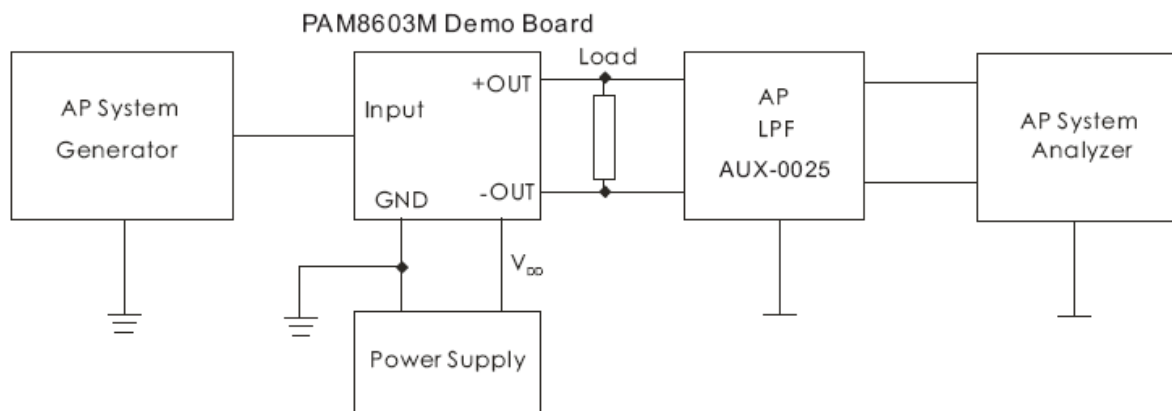

- Notes:
1. The AP AUX-0025 low pass filter is necessary for class-D amplifier measurement done by AP analyzer.
 2. Two 22μH inductors are used in series with load resistor to emulate the small speaker for efficiency measurement.

Mute Operation

The $\overline{\text{MUTE}}$ pin is an input for controlling the output state of the PAM8603M. A logic low on this pin disables the outputs, and a logic high enables the outputs. This pin may be used as a quick disable or enable of the outputs without a volume fade. Quiescent current is listed in the electrical characteristic table. The $\overline{\text{MUTE}}$ pin can be left floating due to the internal pull-up.

For better power-off pop performance, the amplifier should be placed in the mute mode prior to removing the power supply.

Shutdown Operation

In order to reduce power consumption while not in use, the PAM8603M contains shutdown circuitry to turn off the amplifier's bias circuitry. The amplifier is turned off when logic low is placed on the $\overline{\text{SHDN}}$ pin. By switching the $\overline{\text{SHDN}}$ pin connected to GND, the PAM8603M supply current draw will be minimized in idle mode. The $\overline{\text{SHDN}}$ pin can be left floating due to the pull-up.

Power Supply Decoupling

The PAM8603M is a high performance CMOS audio amplifier that requires adequate power supply decoupling to ensure the output THD and PSRR as low as possible. Power supply decoupling affects low frequency response. Optimum decoupling is achieved by using two capacitors of different types that target different noise on the power supply leads. For higher frequency transients, spikes, or digital hash on the line, a good low equivalent-series resistance (ESR) ceramic capacitor, typically 1.0μF, placed as close as possible to the device V_{DD} terminal works best. For filtering lower-frequency noise signals, a large capacitor of 10μF (ceramic) or greater placed near the audio power amplifier is recommended.

Application Information (cont.)

Input Capacitor (C_I)

Large input capacitors are both expensive and space hungry for portable designs. Clearly, a certain sized capacitor is needed to couple in low frequencies without severe attenuation. But in many cases the speakers used in portable systems, whether internal or external, have little ability to reproduce signals below 100Hz to 150Hz. Thus, using a large input capacitor may not increase actual system performance. In this case, input capacitor (C_I) and input resistance (R_I) of the amplifier form a high-pass filter with the corner frequency determined equation below,

$$f_c = \frac{1}{2\pi R_I C_I}$$

In addition to system cost and size, click and pop performance is affected by the size of the input coupling capacitor, C_I. A larger input coupling capacitor requires more charge to reach its quiescent DC voltage (nominally 1/2 V_{DD}). This charge comes from the internal circuit via the feedback and is apt to create pops upon device enable. Thus, by minimizing the capacitor size based on necessary low frequency response, turn-on pops can be minimized.

The Analog Reference Bypass Capacitor (C_{BYP})

The Analog Reference Bypass Capacitor (C_{BYP}) is the most critical capacitor and serves several important functions. During start-up or recovery from shutdown mode, C determines the rate at which the amplifier starts up. The second function is to reduce noise produced by the power supply coupling in the output drive signal. This noise is from the internal analog reference to the amplifier which appears as degraded PSRR and THD+N.

A ceramic bypass capacitor (C_{BYP}) of 0.47μF to 1.0μF is recommended for the best THD and noise performance. Increasing the bypass capacitor reduces clicking and popping noise from power on/off and entering and leaving shutdown.

Under Voltage Lock-Out

The PAM8603M incorporates circuitry to detect low supply voltage. When the supply voltage drops to 1.8V or below, the PAM8603M outputs are disable. The device resumes to normal functional once V_{DD} ≥ 2.0V.

Short Circuit Protection (SCP)

The PAM8603M has short circuit protection circuitry on the outputs to prevent the device from damage when output-to-output or output-to-GND short. When a short circuit is detected on the outputs, the outputs are disabled immediately. If the short was removed, the device activates again.

Over Temperature Protection

Thermal protection on the PAM8603M prevents the device from damage when the internal die temperature exceeds +135°C. There is a 15 degree tolerance on this trip point from device to device. Once the die temperature exceeds the thermal set point, the device outputs are disabled. This is not a latched fault. The thermal fault is cleared once the temperature of the die is reduced by 30°C. This large hysteresis will prevent motor boating sound well. The device begins normal operation at this point without external system interaction.

How to Reduce EMI (Electro Magnetic Interference)

A simple solution is to put an additional capacitor 1000μF at power supply terminal for power line coupling if the traces from amplifier to speakers are short (< 20cm).

Most applications require a ferrite bead filter as shown at Figure 3. The ferrite filter reduces EMI of around 1 MHz and higher. When selecting a ferrite bead, choose one with high impedance at high frequencies, and low impedance at low frequencies (MH2012HM221-T).

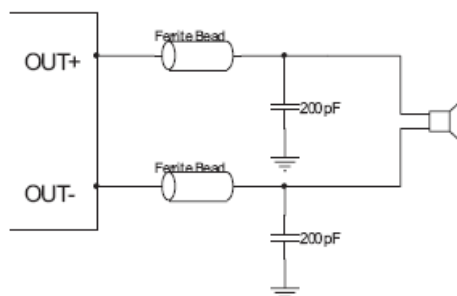

Figure 3. Ferrite Bead Filter to reduce EMI

Application Information (cont.)

PCB Layout Guidelines Grounding

At this stage it is paramount to notice the necessity of separate grounds. Noise currents in the output power stage need to be returned to output noise ground and nowhere else. Were these currents to circulate elsewhere, they may get into the power supply, the signal ground, etc, even worse, they may form a loop and radiate noise. Any of these cases results in degraded amplifier performance. The logical returns for the output noise currents associated with Class-D switching are the respective PGND pins for each channel. The switch state diagram illustrates that PGND is instrumental in nearly every switch state. This is the perfect point to which the output noise ground trace should return. Also note that output noise ground is channel specific. A two channel amplifier has two separate channels and consequently must have two separate output noise ground traces. The layout of the PAM8603M offers separate PGND connections for each channel and in some cases each side of the bridge. Output noise grounds must be tied to system ground at the power exclusively. Signal currents for the inputs, reference, etc need to be returned to quiet ground. This ground is only tied to the signal components and the GND pin, and GND then tied to system ground.

Ordering Information

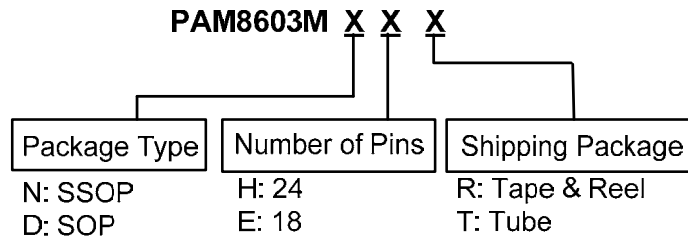

Part Number	Part Marking	Package Type	Standard Package
PAM8603MNHR	PAM8603M XXXYWWLL	SSOP-24	2500 Units/Tape&Reel
PAM8603MDER	PAM8603M XXXYWWLL	SOP-18	1000 Units/Tape&Reel
PAM8603MDET	PAM8603M XXXYWWLL	SOP18	40 Units/Tube

Marking Information

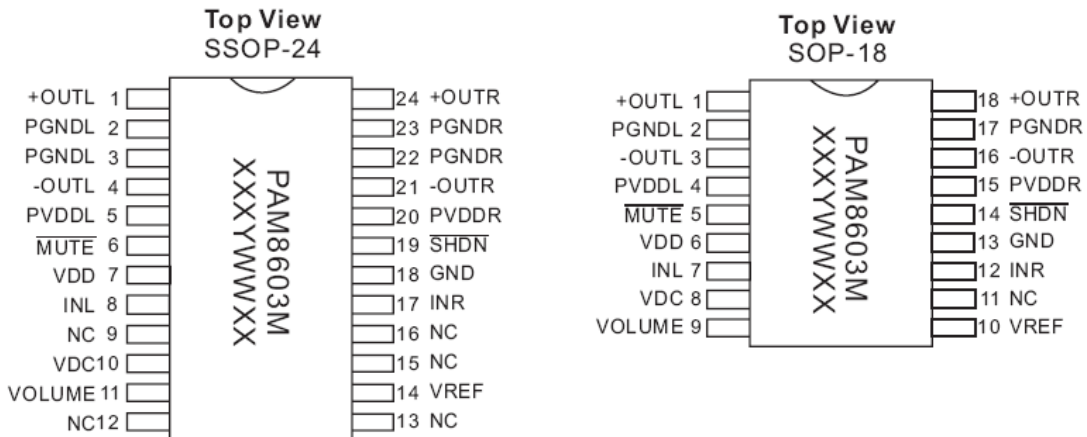

X: Internal Code
Y: Year
WW: Week

Package Outline Dimensions (All dimensions in mm.)

SSOP-24

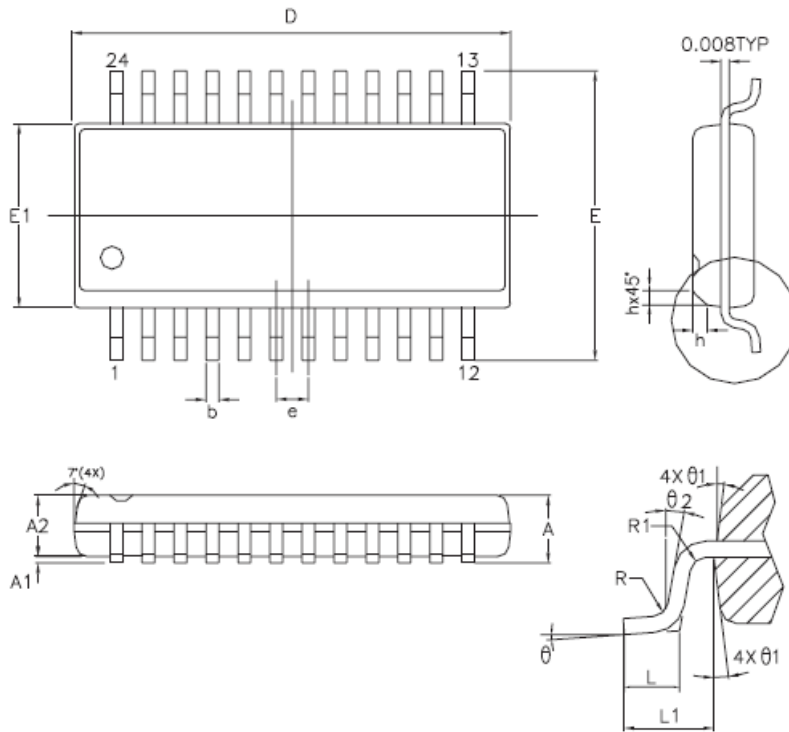

SYMBOLS	MIN.	NOM.	MAX.
A	0.053	0.061	0.069
A1	0.004	-	0.010
A2	0.049	0.057	0.065
b	0.008	0.010	0.012
D	0.335	0.341	0.347
E	0.228	0.236	0.244
E1	0.150	0.154	0.158
e	-	0.025	-
L	0.016	0.033	0.050
L1	0.041 REF		
R	0.003	-	-
R1	0.003	-	-
h	0.010	0.015	0.020
θ^1	0°	4°	8°
θ^2	5°	10°	15°
θ^3	0°	-	-

UNIT : INCH

Package Outline Dimensions (cont.) (All dimensions in mm.)

SOP-18

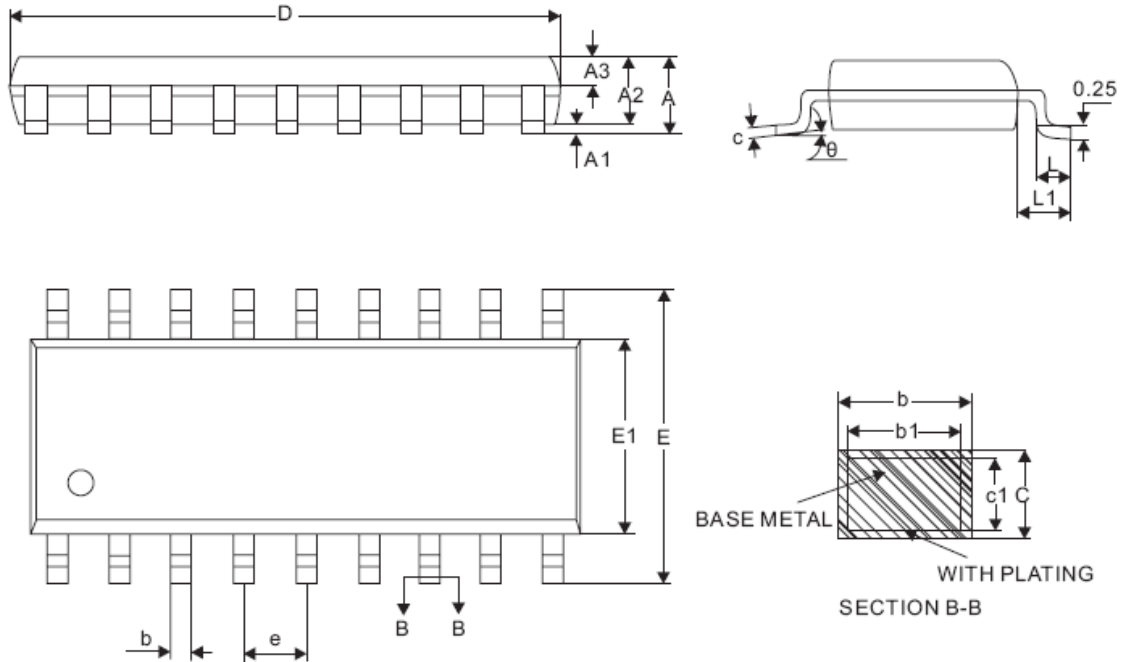

SYMBOL	MILLIMETER		
	MIN	NOM	MAX
A	-	-	2.70
A1	0.08	0.18	0.30
A2	2.10	2.30	2.50
A3	0.92	1.02	1.12
b	0.35	-	0.44
b1	0.34	0.37	0.39
c	0.26	-	0.31
c1	0.24	0.25	0.26
D	11.25	11.45	11.76
E	10.00	10.30	10.64
E1	7.30	7.50	7.70
e	1.27BSC		
L	0.70	0.85	1.00
L1	1.40BSC		
θ	0°	-	8°

IMPORTANT NOTICE

DIODES INCORPORATED MAKES NO WARRANTY OF ANY KIND, EXPRESS OR IMPLIED, WITH REGARDS TO THIS DOCUMENT, INCLUDING, BUT NOT LIMITED TO, THE IMPLIED WARRANTIES OF MERCHANTABILITY AND FITNESS FOR A PARTICULAR PURPOSE (AND THEIR EQUIVALENTS UNDER THE LAWS OF ANY JURISDICTION).

Diodes Incorporated and its subsidiaries reserve the right to make modifications, enhancements, improvements, corrections or other changes without further notice to this document and any product described herein. Diodes Incorporated does not assume any liability arising out of the application or use of this document or any product described herein; neither does Diodes Incorporated convey any license under its patent or trademark rights, nor the rights of others. Any Customer or user of this document or products described herein in such applications shall assume all risks of such use and will agree to hold Diodes Incorporated and all the companies whose products are represented on Diodes Incorporated website, harmless against all damages.

Diodes Incorporated does not warrant or accept any liability whatsoever in respect of any products purchased through unauthorized sales channel. Should Customers purchase or use Diodes Incorporated products for any unintended or unauthorized application, Customers shall indemnify and hold Diodes Incorporated and its representatives harmless against all claims, damages, expenses, and attorney fees arising out of, directly or indirectly, any claim of personal injury or death associated with such unintended or unauthorized application.

Products described herein may be covered by one or more United States, international or foreign patents pending. Product names and markings noted herein may also be covered by one or more United States, international or foreign trademarks.

This document is written in English but may be translated into multiple languages for reference. Only the English version of this document is the final and determinative format released by Diodes Incorporated.

LIFE SUPPORT

Diodes Incorporated products are specifically not authorized for use as critical components in life support devices or systems without the express written approval of the Chief Executive Officer of Diodes Incorporated. As used herein:

A. Life support devices or systems are devices or systems which:

1. are intended to implant into the body, or
2. support or sustain life and whose failure to perform when properly used in accordance with instructions for use provided in the labeling can be reasonably expected to result in significant injury to the user.

B. A critical component is any component in a life support device or system whose failure to perform can be reasonably expected to cause the failure of the life support device or to affect its safety or effectiveness.

Customers represent that they have all necessary expertise in the safety and regulatory ramifications of their life support devices or systems, and acknowledge and agree that they are solely responsible for all legal, regulatory and safety-related requirements concerning their products and any use of Diodes Incorporated products in such safety-critical, life support devices or systems, notwithstanding any devices- or systems-related information or support that may be provided by Diodes Incorporated. Further, Customers must fully indemnify Diodes Incorporated and its representatives against any damages arising out of the use of Diodes Incorporated products in such safety-critical, life support devices or systems.

Copyright © 2012, Diodes Incorporated

www.diodes.com

Looking for pricing, stock, or lifecycle information?

Click below to explore more details on WIN SOURCE:

 [View PAM8603MNHR on WIN SOURCE](#)

 [Diodes Incorporated Information](#)

Optimize Your Supply Chain with WIN SOURCE Solutions

-  Global Sourcing Solution
-  Obsolete Management
-  Cost Control Management
-  Shortage Management
-  Alternative Solution
-  Excess Inventory Management