



# THE DATASHEET OF PAM8404KGR



**3W/CH FILTERLESS STEREO CLASS-D AUDIO AMPLIFIER**

**Description**

The PAM8404 is a 3W high efficiency filterless Class-D audio amplifier in 4mmX4mm and 2mmX2mm wafer chip scale (WCSP) packages that requires few external components.

Features like 89% efficiency, -63dB PSRR, improved RF-rectification immunity, and very small PCB area make the PAM8404 Class-D amplifier ideal for cellular handset and PDA applications.

In cellular handsets, the earpiece, speaker phone, and melody ringer can each be driven by the PAM8404. The PAM8404 allows independent gain by summing signals from separate sources, and has as low as 43µV noise floor.

PAM8404 is available in QFN 4mmx4mm and WCSP 2mmx2mm packages.

**Features**

- 3W Output at 10% THD with a 4Ω Load and 5V Supply
- Supply Voltage from 2.5V to 5.5V
- Efficiency Up to 89%
- Superior Low Noise without Input
- Few External Components to Save the Space and Cost
- Short Circuit Protection
- Thermal Shutdown
- Space Saving Packages :
  - 2mm X 2mm WCSP
  - 4mm X 4mm Thin QFN
- Pb-Free Packages

**Applications**

- LCD Monitor / TV Projector
- Notebook Computers
- Portable Speakers
- Portable DVD Players, Game Machines
- Cellular Phones/Speaker Phones

**Pin Assignments**

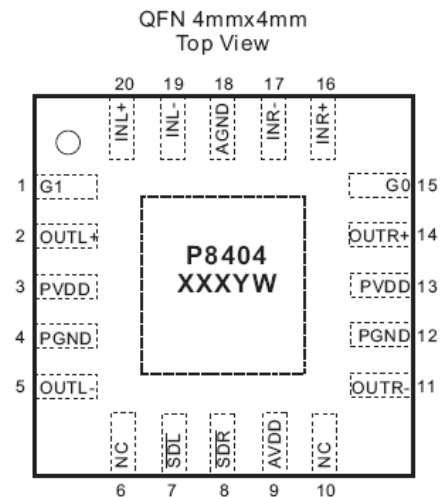
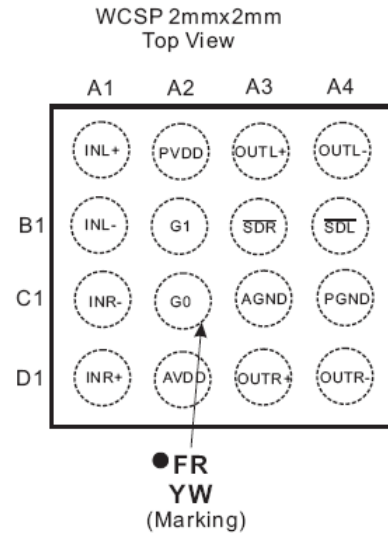

## Typical Applications Circuit

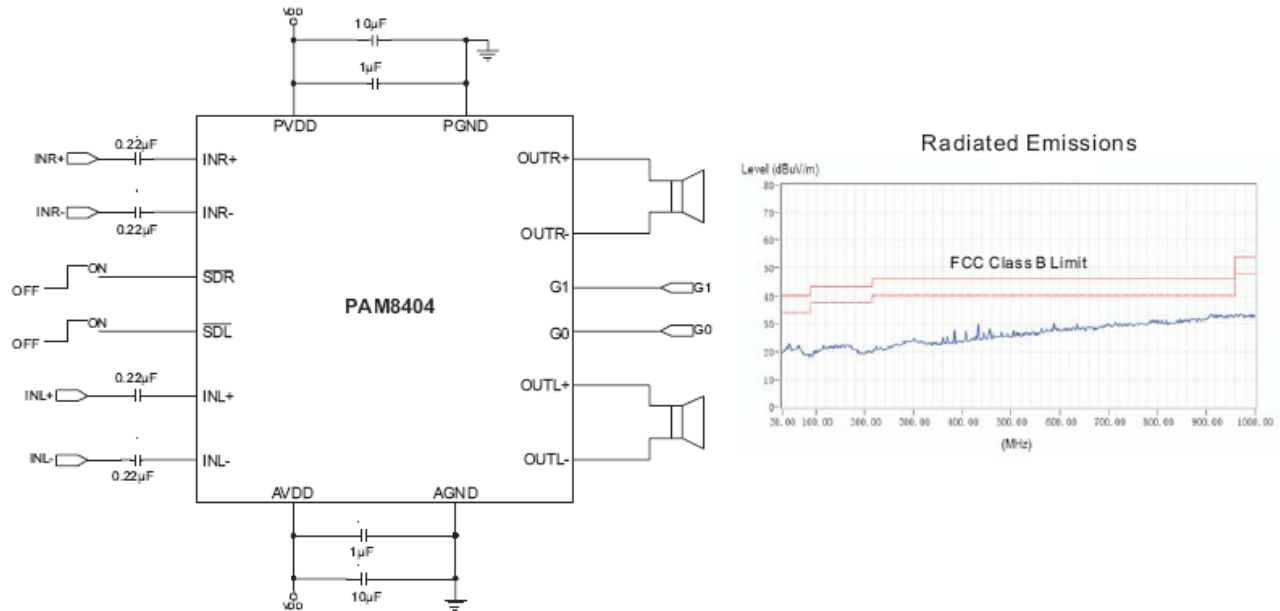

## Pin Descriptions

Pin Name	Pin Number		Function
	QFN4x4	WCSP2x2	
G1	1	B2	Gain Select (MSB)
OUTL+	2	A3	Left Channel Positive Differential Output
PVDD	313	A2	Power Supply (Must be Same Voltage as AVDD)
PGND	412	C4	Power Ground
OUTL-	5	A4	Left Channel Negative Differential Output
NC	610	—	Not Connected
SDL	7	B4	Left Channel Shutdown Terminal (active low)
SDR	8	B3	Right Channel Shutdown Terminal (active low)
AVDD	9	D2	Analog Supply (Must be Same Voltage as PVDD)
OUTR-	11	D4	Right Channel Negative Differential Output
OUTR+	14	D3	Right Channel Positive Differential Output
G0	15	C2	Gain Select (LSB)
INR+	16	D1	Right Channel Positive Input
INR-	17	C1	Right Channel Negative Input
AGND	18	C3	Analog Ground
INL-	19	B1	Left Channel Negative Input
INL+	20	A1	Left Channel Positive Input

**Functional Block Diagram**

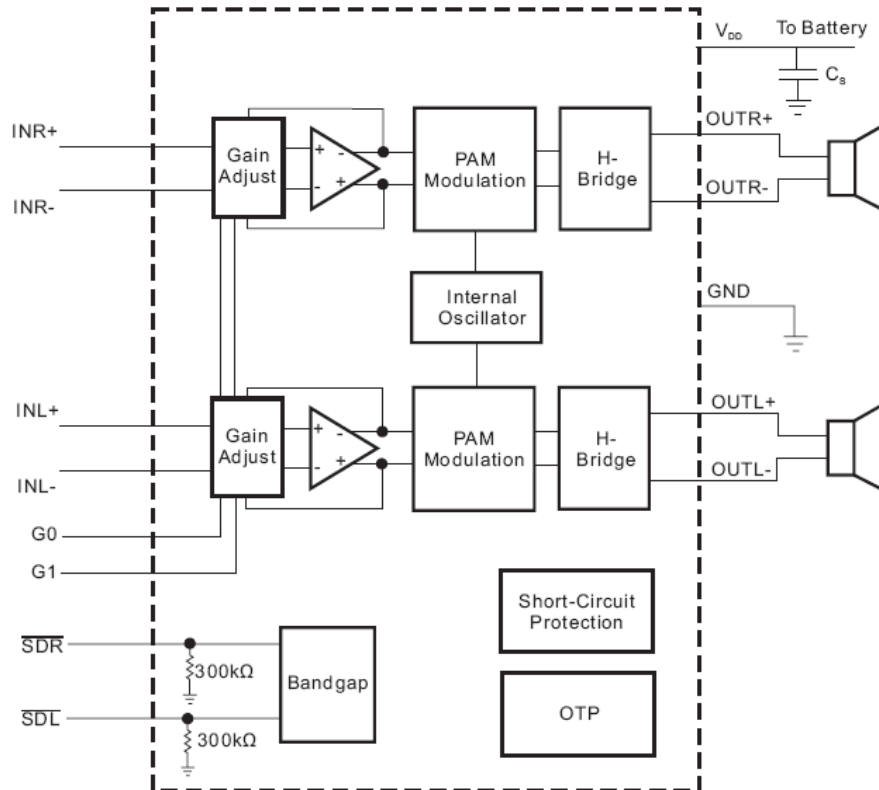

**Absolute Maximum Ratings** (@T<sub>A</sub> = +25°C, unless otherwise specified.)

These are stress ratings only and functional operation is not implied. Exposure to absolute maximum ratings for prolonged time periods may affect device reliability. All voltages are with respect to ground.

Parameter	Rating	Unit
Supply Voltage	6.0	V
Input Voltage	-0.3 to V <sub>DD</sub> +0.3	
Maximum Junction Temperature	150	°C
Storage Temperature	-65 to +150	
Soldering Temperature	250, 10sec	

**Recommended Operating Conditions** (@T<sub>A</sub> = +25°C, unless otherwise specified.)

Parameter	Rating	Unit
Supply Voltage Range	2.5 to 5.5	V
Operation Temperature Range	-40 to +85	°C
Junction Temperature Range	-40 to +125	°C

## Thermal Information

Parameter	Package	Symbol	Max	Unit
Thermal Resistance (Junction to Ambient)	WCSP2x2-16	$\theta_{JA}$	64	°C/W
	QFN4x4-20		31	
Thermal Resistance (Junction to Case)	WCSP2x2-16	$\theta_{JC}$	—	
	QFN4x4-20		13	

## Electrical Characteristics (@T<sub>A</sub> = +25°C, AV<sub>DD</sub> = PV<sub>DD</sub> = 5V, GND = PGND = 0V, unless otherwise specified.)

### QFN4x4-20

Symbol	Parameter	Test Conditions	Min	Typ	Max	Units
V <sub>DD</sub>	Supply Power		2.5		5.5	V
P <sub>O</sub>	Output Power	THD+N = 10%, f = 1kHz, R <sub>L</sub> = 4Ω	V <sub>DD</sub> = 5.0V	3		W
			V <sub>DD</sub> = 3.6V	1.5		
		THD+N = 1%, f = 1kHz, R <sub>L</sub> = 4Ω	V <sub>DD</sub> = 5.0V	2.35		W
			V <sub>DD</sub> = 3.6V	1.2		
		THD+N = 10%, f = 1kHz, R <sub>L</sub> = 8Ω	V <sub>DD</sub> = 5.0V	1.7		W
			V <sub>DD</sub> = 3.6V	0.9		
		THD+N = 1%, f = 1kHz, R <sub>L</sub> = 8Ω	V <sub>DD</sub> = 5.0V	1.4		W
			V <sub>DD</sub> = 3.6V	0.7		
THD+N	Total Harmonic Distortion Plus Noise	V <sub>DD</sub> = 5.0V, P <sub>O</sub> = 0.5W, R <sub>L</sub> = 8Ω	f = 1kHz	0.15		%
		V <sub>DD</sub> = 3.6V, P <sub>O</sub> = 0.5W, R <sub>L</sub> = 8Ω		0.27		
		V <sub>DD</sub> = 5.0V, P <sub>O</sub> = 1W, R <sub>L</sub> = 4Ω	f = 1kHz	0.23		%
		V <sub>DD</sub> = 3.6V, P <sub>O</sub> = 1W, R <sub>L</sub> = 4Ω		0.24		
PSRR	Power Supply Ripple Rejection	V <sub>DD</sub> = 5.0V, Inputs AC-Grounded with C <sub>IN</sub> = 1.0μF	f = 100kHz	-48		dB
			f = 1kHz	-63		
C <sub>S</sub>	Crosstalk	V <sub>DD</sub> = 5V, P <sub>O</sub> = 0.5W, R <sub>L</sub> = 4Ω, G <sub>v</sub> = 23dB	f = 1kHz	-93		dB
SNR	Signal-to-Noise	V <sub>DD</sub> = 5V, V <sub>ORMS</sub> = 1V, G <sub>v</sub> = 23dB	A-weighting	87		dB
V <sub>N</sub>	Output Noise	V <sub>DD</sub> = 5V, Inputs AC-Grounded with C <sub>IN</sub> = 1μF	A-weighting	43		μV
			BW 22Hz – 22kHz	No A-weighting	59	
Dyn	Dynamic Range	V <sub>DD</sub> = 5V, THD = 1%	A-weighting	97		dB
η	Efficiency	R <sub>L</sub> = 8Ω, THD = 10%	f = 1kHz	89		%
		R <sub>L</sub> = 4Ω, THD = 10%		84		
I <sub>Q</sub>	Quiescent Current	V <sub>DD</sub> = 5.0V	No load	11		mA
		V <sub>DD</sub> = 3.6V		6		
I <sub>SD</sub>	Shutdown Current	V <sub>DD</sub> = 5.5V	V <sub>SD</sub> = 0.3V	< 1		μA
R <sub>DS(ON)</sub>	Static Drain-to-Source On-State Resistor	I <sub>DS</sub> = 500mA, V <sub>GS</sub> = 5V	PMOS	250		mΩ
			NMOS	170		
f <sub>sw</sub>	Switching Frequency	V <sub>DD</sub> = 3V to 5V		300		kHz
V <sub>OS</sub>	Output Offset Voltage	V <sub>IN</sub> = 0V, V <sub>DD</sub> = 5V		10		mV
Gain	Closed-Loop Voltage Gain	V <sub>DD</sub> = 5V, R <sub>L</sub> = 4Ω, f = 1kHz	G <sub>0</sub> = L, G <sub>1</sub> = L	6		dB
			G <sub>0</sub> = H, G <sub>1</sub> = L	12		
			G <sub>0</sub> = L, G <sub>1</sub> = H	18		
			G <sub>0</sub> = H, G <sub>1</sub> = H	24		
OTP	Over Temperature Protection	No Load, Junction Temperature	V <sub>DD</sub> = 5V	150		°C
OTH	Over Temperature Hysteresis			50		

**Electrical Characteristics** (@T<sub>A</sub> = +25°C, AVDD = PVDD = 5V, GND = PGND = 0V, unless otherwise specified.)

**WCSP2x2-16**

Symbol	Parameter	Test Conditions	Min	Typ	Max	Units
V <sub>DD</sub>	Supply Power		2.5		5.5	V
P <sub>O</sub>	Output Power	THD+N = 10%, f = 1kHz, R <sub>L</sub> = 4Ω	V <sub>DD</sub> = 5.0V	2.2		W
			V <sub>DD</sub> = 3.6V	1.2		
		THD+N = 1%, f = 1kHz, R <sub>L</sub> = 4Ω	V <sub>DD</sub> = 5.0V	1.8		W
			V <sub>DD</sub> = 3.6V	1		
		THD+N = 10%, f = 1kHz, R <sub>L</sub> = 8Ω	V <sub>DD</sub> = 5.0V	1.5		W
			V <sub>DD</sub> = 3.6V	0.8		
		THD+N = 1%, f = 1kHz, R <sub>L</sub> = 8Ω	V <sub>DD</sub> = 5.0V	1.2		W
			V <sub>DD</sub> = 3.6V	0.6		
THD+N	Total Harmonic Distortion Plus Noise	V <sub>DD</sub> = 5.0V, P <sub>O</sub> = 0.5W, R <sub>L</sub> = 8Ω	f = 1kHz	0.3		%
		V <sub>DD</sub> = 3.6V, P <sub>O</sub> = 0.5W, R <sub>L</sub> = 8Ω		0.4		
		V <sub>DD</sub> = 5.0V, P <sub>O</sub> = 1W, R <sub>L</sub> = 4Ω	f = 1kHz	0.3		%
		V <sub>DD</sub> = 3.6V, P <sub>O</sub> = 1W, R <sub>L</sub> = 4Ω		0.2		
PSRR	Power Supply Ripple Rejection	V <sub>DD</sub> = 5.0V, Inputs AC-Grounded with C <sub>IN</sub> = 1.0μF	f = 217kHz	-50		dB
C <sub>s</sub>	Crosstalk	V <sub>DD</sub> = 5.0V, P <sub>O</sub> = 0.5W, R <sub>L</sub> = 4Ω, G <sub>v</sub> = 23dB	f = 1kHz	-70		dB
SNR	Signal-to-Noise	V <sub>DD</sub> = 5V, V <sub>ORMS</sub> = 1V <sub>Gv</sub> = 23dB	A-weighting	85		dB
V <sub>N</sub>	Output Noise	V <sub>DD</sub> = 5V, Inputs AC-Grounded with C <sub>IN</sub> = 0.47μF	A-weighting	34		μV
		BW 22Hz – 22kHz	No A-weighting	54		
Dyn	Dynamic Range	V <sub>DD</sub> = 5V, THD = 1%	A-weighting	98		dB
η	Efficiency	R <sub>L</sub> = 8Ω, THD = 10%	f = 1kHz	85		%
		R <sub>L</sub> = 4Ω, THD = 10%		75		
I <sub>Q</sub>	Quiescent Current	V <sub>DD</sub> = 5.0V	No load	12		mA
		V <sub>DD</sub> = 3.6V		7		
I <sub>SD</sub>	Shutdown Current	V <sub>DD</sub> = 2.5V to 5.5V	V <sub>SD</sub> = 0.3V	< 1		μA
R <sub>DS(ON)</sub>	Static Drain-to-Source On-State Resistor	I <sub>DS</sub> = 500mA, V <sub>GS</sub> = 5V	PMOS	500		mΩ
			NMOS	460		
f <sub>sw</sub>	Switching Frequency	V <sub>DD</sub> = 5V		300		kHz
V <sub>OS</sub>	Output Offset Voltage	V <sub>IN</sub> = 0V, V <sub>DD</sub> = 5V		20		mV
Gain	Closed-Loop Voltage Gain	V <sub>DD</sub> = 5V, R <sub>L</sub> = 4Ω, f = 1kHz	G <sub>0</sub> = L, G <sub>1</sub> = L	6		dB
			G <sub>0</sub> = H, G <sub>1</sub> = L	12		
			G <sub>0</sub> = L, G <sub>1</sub> = H	18		
			G <sub>0</sub> = H, G <sub>1</sub> = H	24		
OTP	Over Temperature Protection	No Load, Junction Temperature	V <sub>DD</sub> = 5V	150		°C
OTH	Over Temperature Hysterisis			50		

**Typical Performance Characteristics** (@T<sub>A</sub> = +25°C, unless otherwise specified.)

**QFN4X4-20**

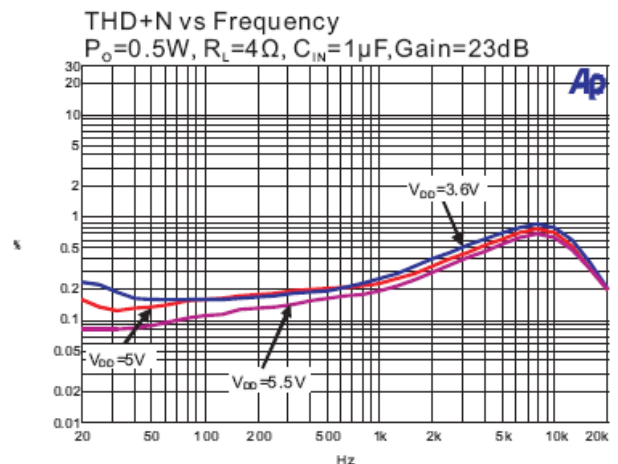
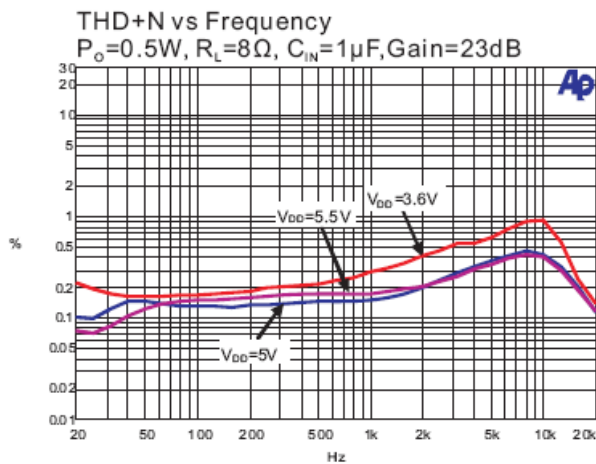
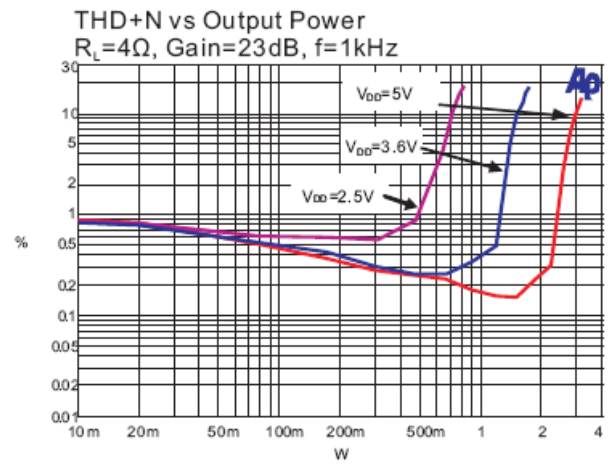
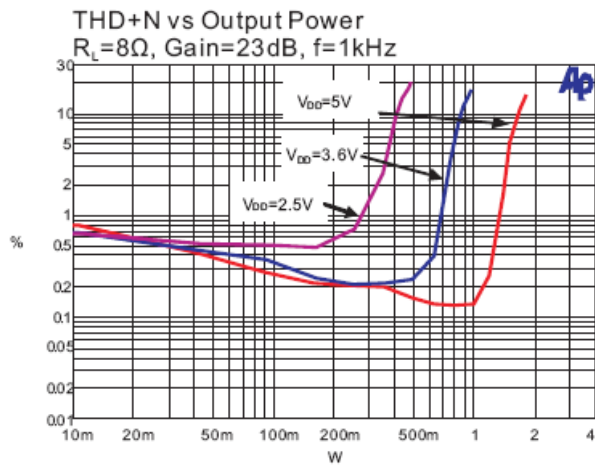
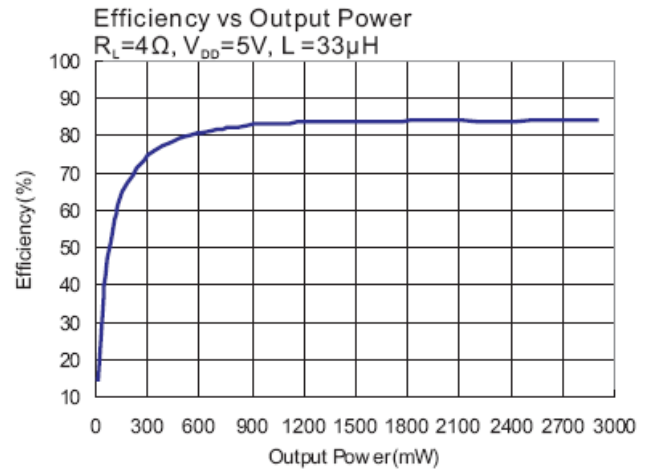
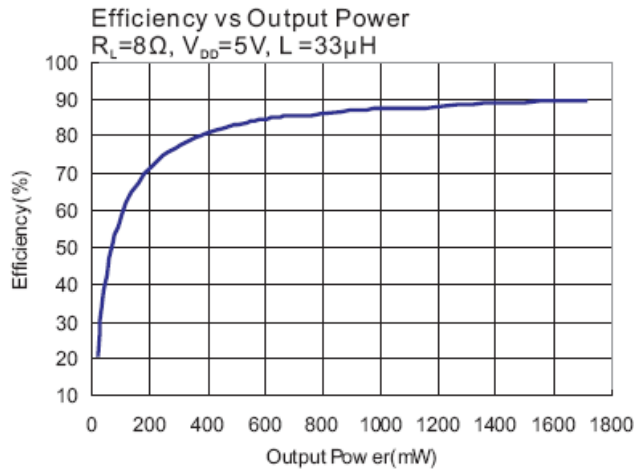

**Typical Performance Characteristics** (cont.) (@T<sub>A</sub> = +25°C, unless otherwise specified.)

QFN4X4-20

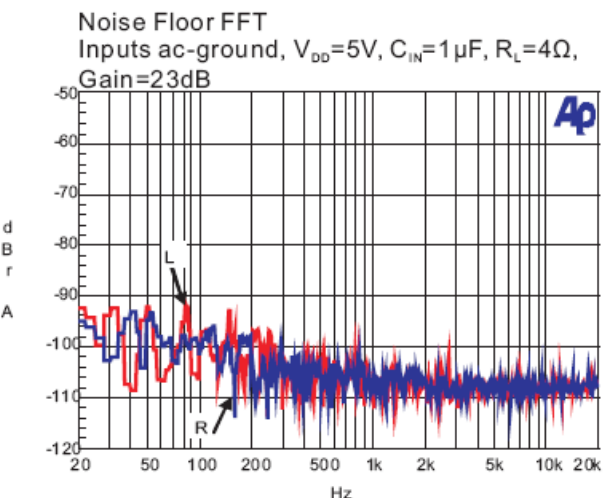
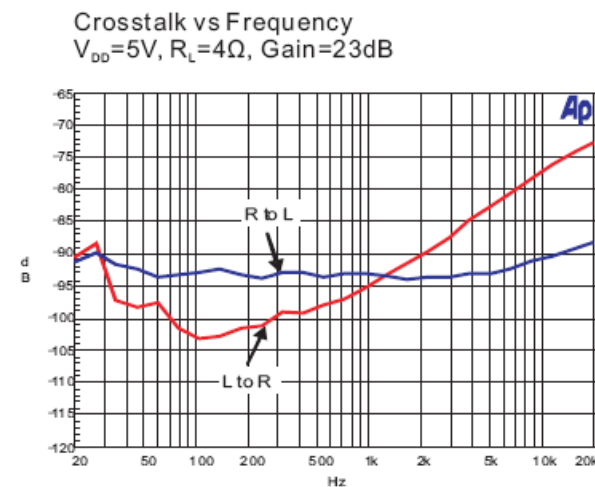
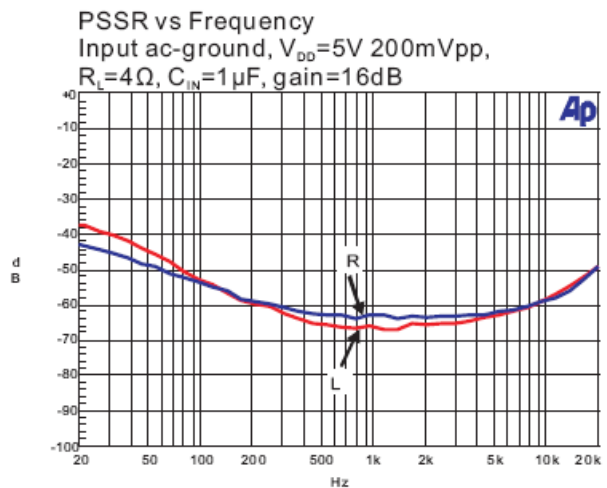
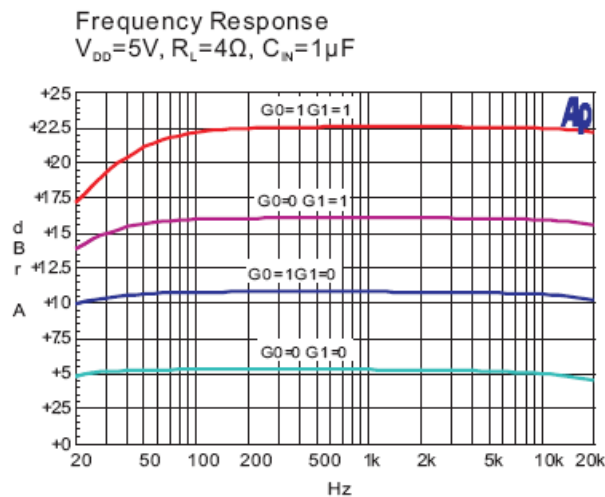
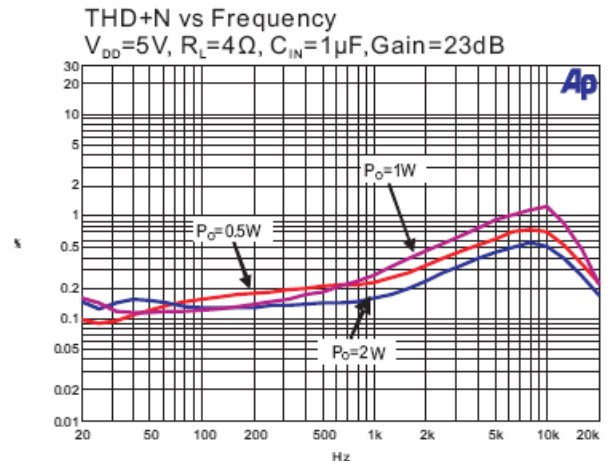
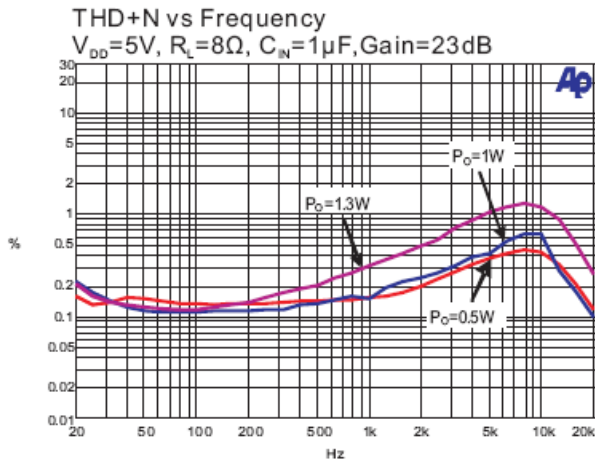

**Typical Performance Characteristics** (cont.) (@T<sub>A</sub> = +25°C, unless otherwise specified.)

QFN4X4-20

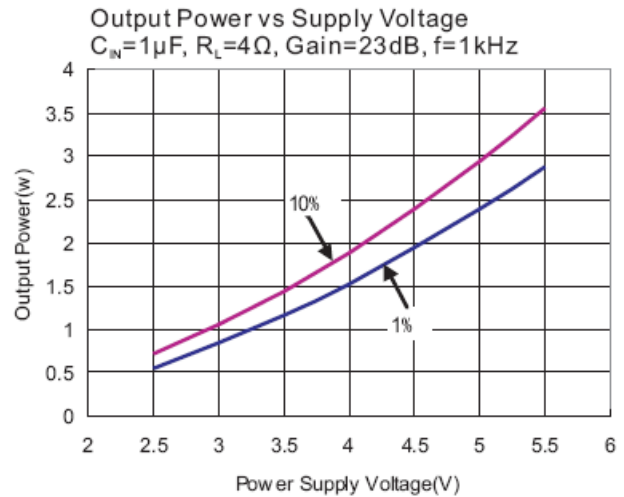
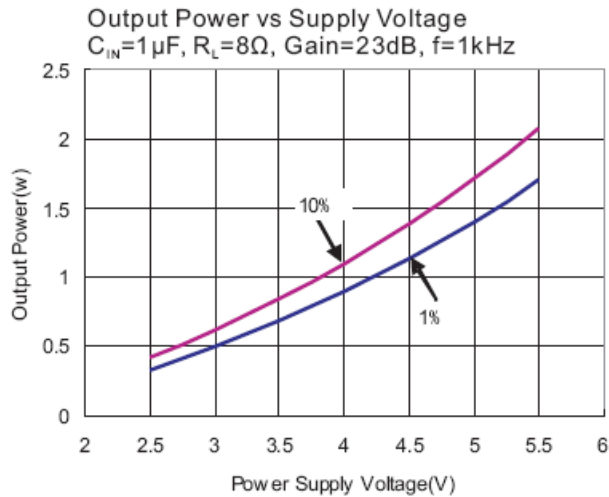
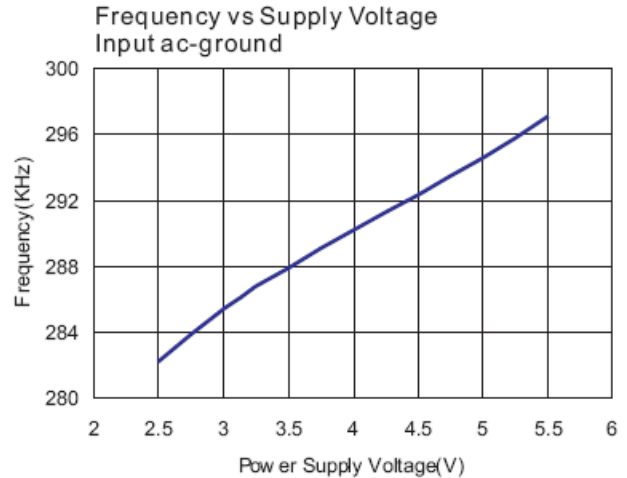
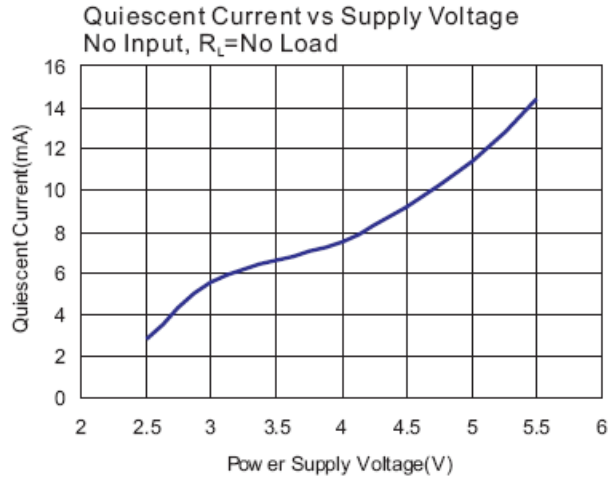

**Typical Performance Characteristics** (cont.) (@T<sub>A</sub> = +25°C, unless otherwise specified.)

WCSP2x2-16

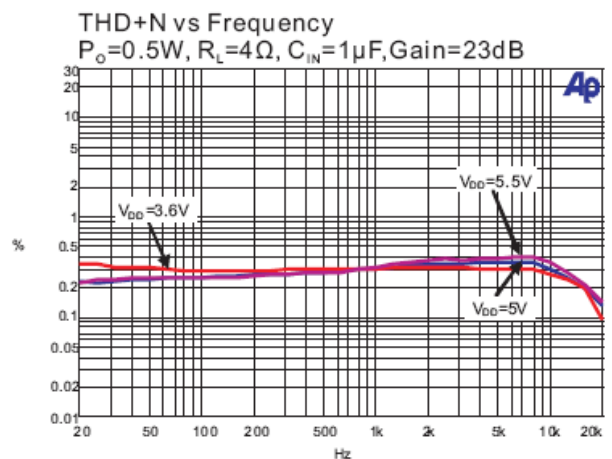
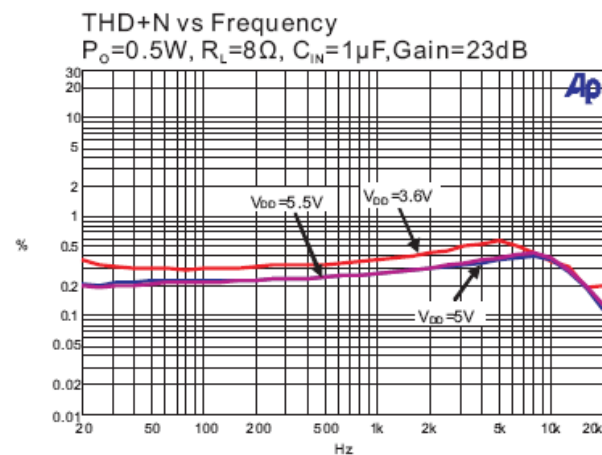
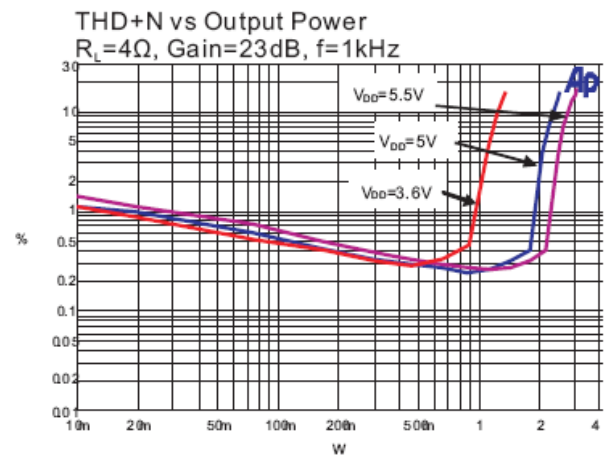
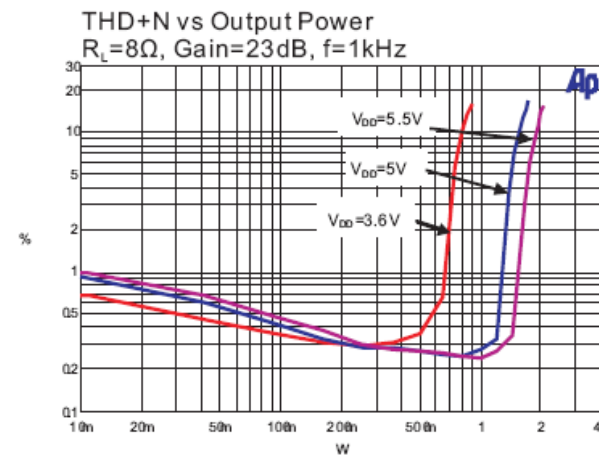
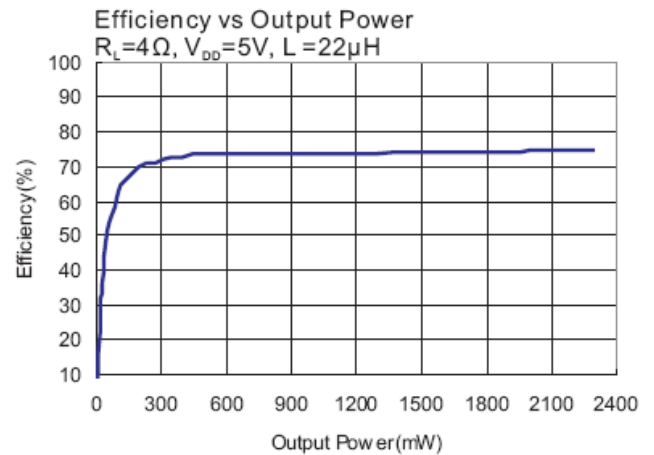
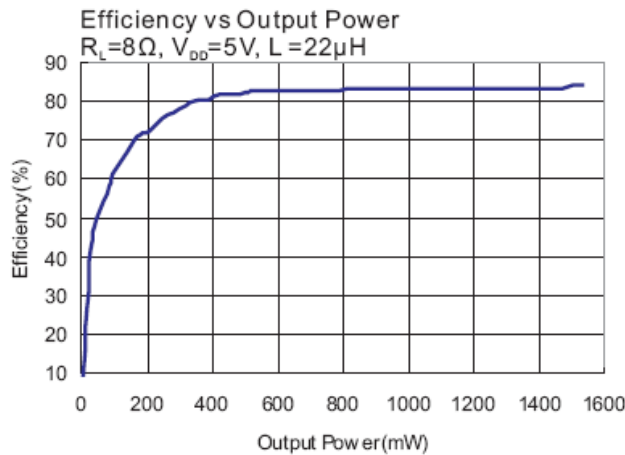

**Typical Performance Characteristics** (cont.) (@ $T_A = +25^\circ\text{C}$ , unless otherwise specified.)

WCSP2x2-16

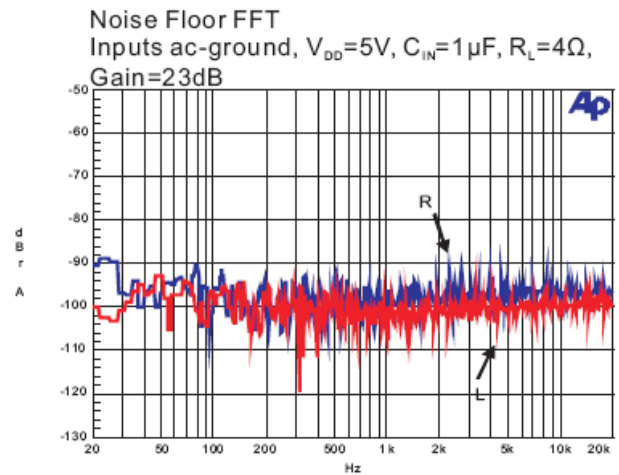
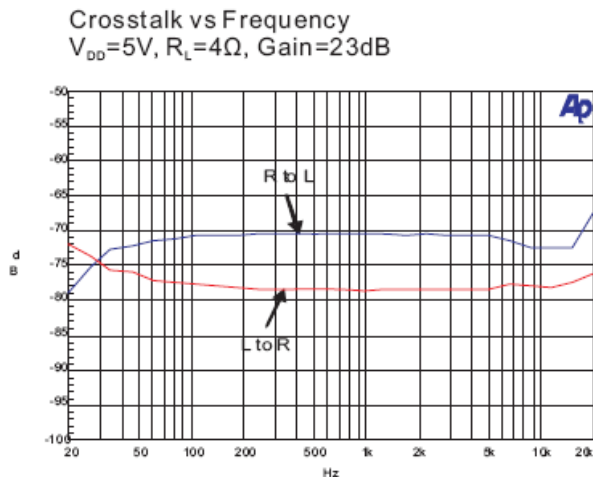
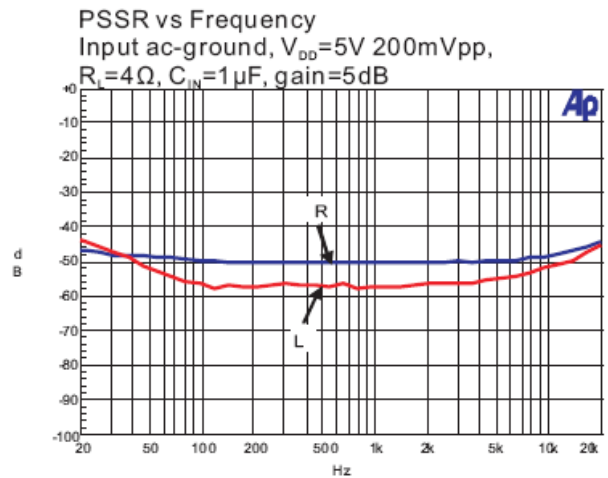
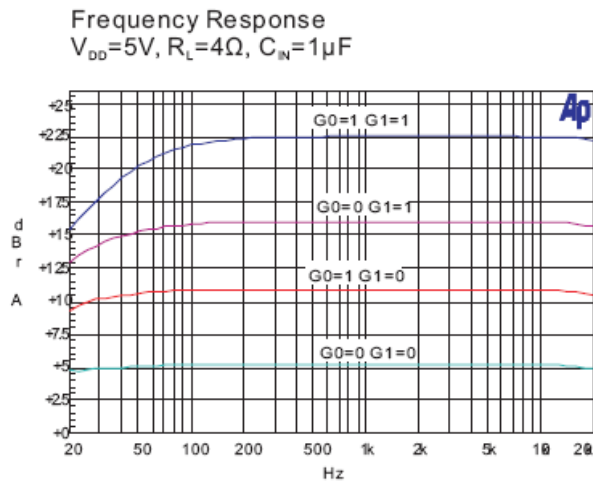
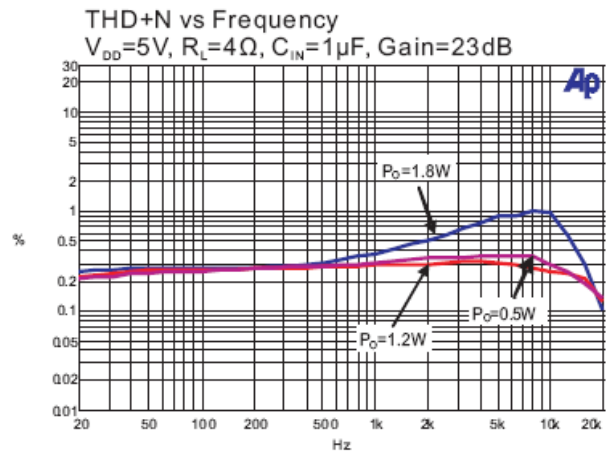
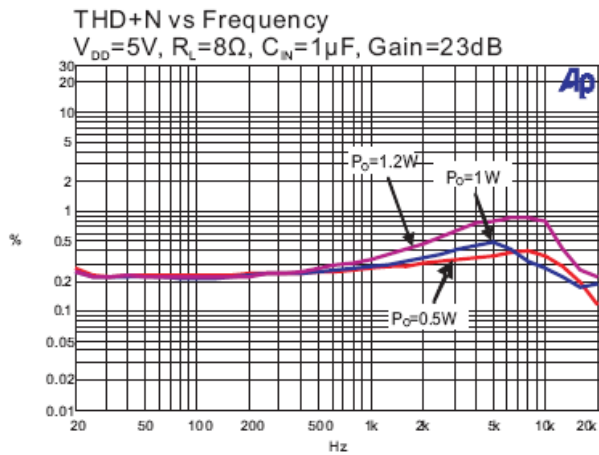

**Typical Performance Characteristics** (cont.) (@T<sub>A</sub> = +25°C, unless otherwise specified.)

WCSP2x2-16

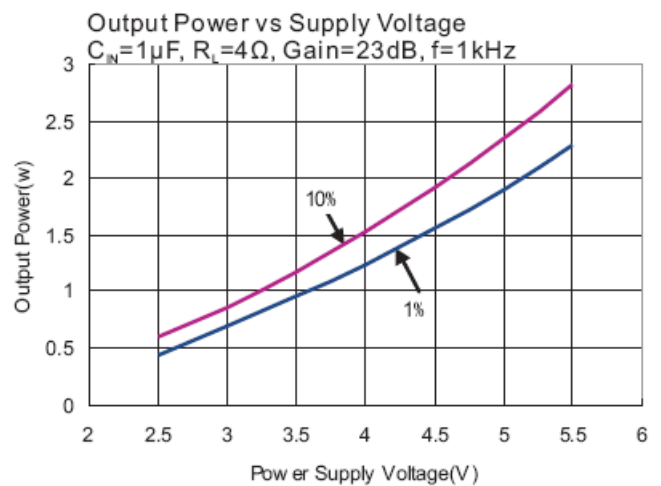
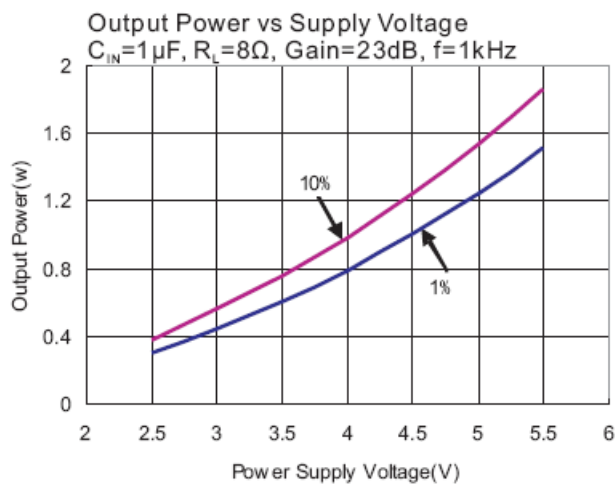
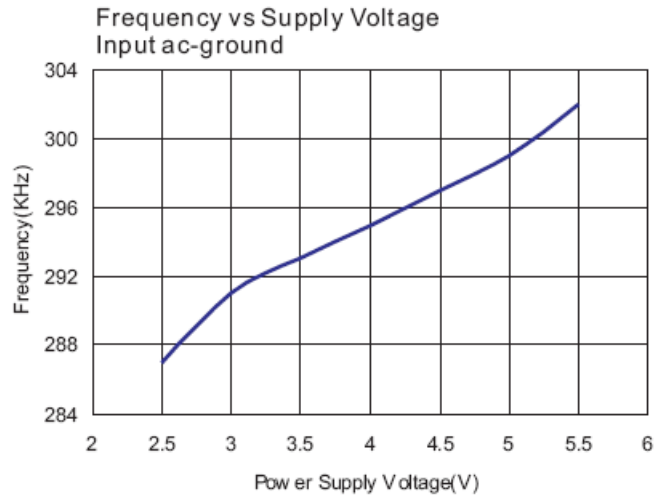
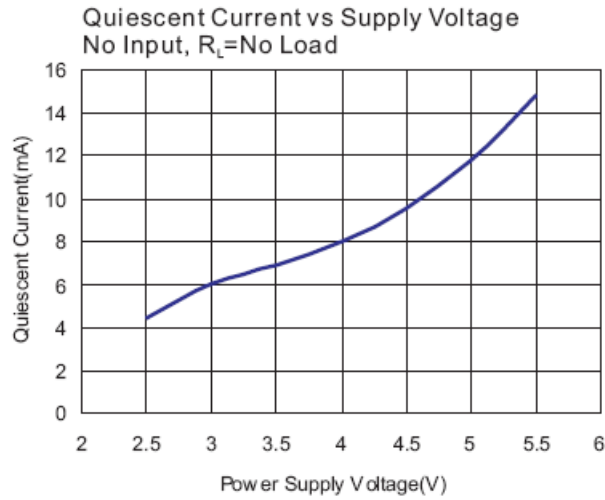

## Application Information

### Test Setup for Performance Testing

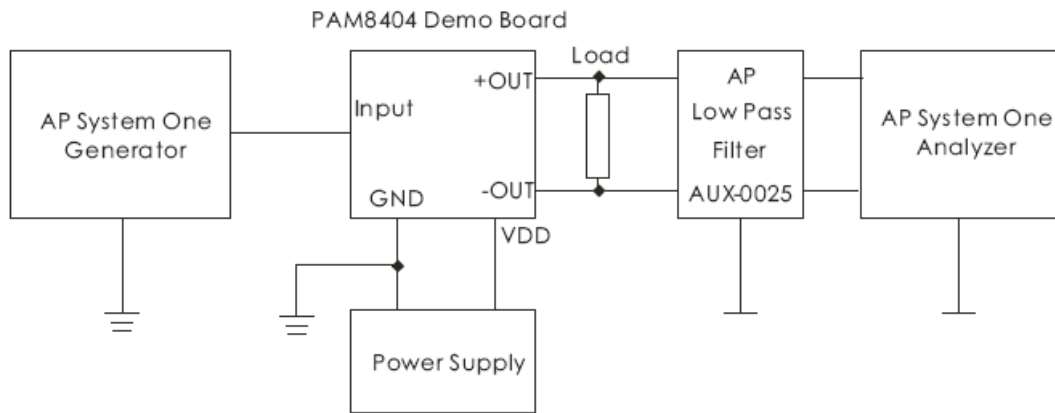

- Notes:
1. The AP AUX-0025 low pass filter is necessary for class-D amplifier measurement with AP analyzer.
  2. Two 22μH inductors are used in series with load resistor to emulate the small speaker for efficiency measurement.

### Gain Settin

The gain of PAM8404 can be selected as 6, 12, 18 or 24 dB utilizing the G0 and G1 gain setting pins. The gains showed in the following table are realized by changing the input resistors inside the amplifier. The input impedance changes with the gain setting.

**Table 1. Gain Setting**

G1	G0	Gain (V/V)	Gain (dB)	Input Impedance (kΩ)
0	0	2	6	28.1
0	1	4	12	17.3
1	0	8	18	9.8
1	1	16	24	5.2

For optimal performance the gain should be set to 2x ( $R_i = 150k\Omega$ ). Lower gain allows the PAM8404 to operate at its best, and keeps a high voltage at the input making the inputs less susceptible to noise. In addition to these features, lower value of Gain minimizes pop noise.

### Input Capacitors ( $C_i$ )

In the typical application, an input capacitor,  $C_i$ , is required to allow the amplifier to bias the input signal to the proper DC level for optimum operation. In this case,  $C_i$  and the input impedance  $R_i$  form a high-pass filter with the corner frequency determined by the follow equation:

$$f_c = \frac{1}{2\pi R_i C_i}$$

It is important to consider the value of  $C_i$  as it directly affects the low frequency performance of the circuit. When  $R_i$  is 28.1kΩ and the specification calls for a flat bass response are down to 200Hz, the equation is reconfigured as follows:

$$C_i = \frac{1}{2\pi R_i f_c}$$

When input resistance variation is considered, the  $C_i$  is 28nF, so one would likely choose a value of 33nF. A further consideration for this capacitor is the leakage path from the input source through the input network ( $C_i$ ,  $R_i + R_F$ ) to the load. This leakage current creates a DC offset voltage at the input to the amplifier that reduces useful headroom, especially in high gain applications.

## Application Information

### Input Capacitors (C<sub>i</sub>) (cont.)

For this reason, a low-leakage tantalum or ceramic capacitor is the best choice. When polarized capacitors are used, the positive side of the capacitor should face the amplifier input in most applications as the DC level is held at  $V_{DD}/2$ , which is likely higher than the source DC level. Please note that it is important to confirm the capacitor polarity in the application.

If the corner frequency is within the audio band, the capacitors should have a tolerance  $\pm 10\%$  or better, because any mismatch in capacitance cause an impedance mismatch at the corner frequency and below.

### Decoupling Capacitor (C<sub>S</sub>)

The PAM8404 is a high-performance CMOS audio amplifier that requires adequate power supply decoupling to ensure the output total harmonic distortion (THD) as low as possible. Power supply decoupling also prevents the oscillations causing by long lead length between the amplifier and the speaker.

The optimum decoupling is achieved by using two different types of capacitors that target on different types of noise on the power supply leads. For higher frequency transients, spikes, or digital hash on the line, a good low equivalent series-resistance (ESR) ceramic capacitor, typically  $1\mu\text{F}$ , is placed as close as possible to the device each  $V_{DD}$  and  $PV_{DD}$  pin for the best operation. For filtering lower frequency noise signals, a large ceramic capacitor of  $10\mu\text{F}$  or greater placed near the audio power amplifier is recommended.

### How to Reduce EMI

Most applications require a ferrite bead filter for EMI elimination as shown in Figure 1. The ferrite filter reduces EMI of around 1MHz and higher. When selecting a ferrite bead, choose one with high impedance at high frequencies and low impedance at low frequencies.

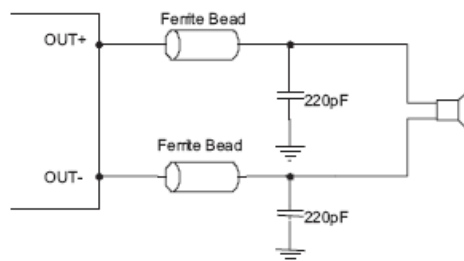

Figure 1. Ferrite Bead Filter to Reduce EMI

### Shutdown Operation

In order to reduce power consumption while not in use, the PAM8404 contains shutdown circuitry to turn off the amplifier's bias circuitry. It features independent shutdown controls for each channel. This shutdown turns the amplifier off when logic low is placed on the  $\overline{\text{SDx}}$  pin. By switching the shutdown pin to GND, the PAM8404 supply current draw will be minimized in idle mode.

### Short Circuit Protection (SCP)

The PAM8404 has short circuit protection circuitry on the outputs to prevent the device from damage when output-to-output shorts or output-to-GND shorts occur. When a short circuit occurs, the device immediately goes into shutdown state. Once the short is removed, the device will be reactivated.

### Over Temperature Protection (OTP)

Thermal protection on the PAM8404 prevents the device from damage when the internal die temperature exceeds  $+150^{\circ}\text{C}$ . There is a  $+15^{\circ}\text{C}$  tolerance on this trip point from device to device. Once the die temperature exceeds the set point, the device will enter the shutdown state and the outputs are disabled. This is not a latched fault. The thermal fault is cleared once the temperature of the die decreased by  $50^{\circ}\text{C}$ . This large hysteresis will prevent motor boating sound well and the device begins normal operation at this point with no external system interaction.

## Application Information

### POP and Click Circuitry

The PAM8404 contains circuitry to minimize turnon and turn-off transients or “click and pops”, where turn-on refers to either power supply turnon or device recover from shutdown mode. When the device is turned on, the amplifiers are internally muted. An internal current source ramps up the internal reference voltage. The device will remain in mute mode until the reference voltage reach half supply voltage  $V_{DD}/2$ . As soon as the reference voltage is stable, the device will begin full operation. For the best power-off pop performance, the amplifier should be set in shutdown mode prior to removing the power supply voltage.

### PCB Layout Guidelines

#### Grounding

It is recommended to use plane grounding or separate grounds. Do not use one line connecting power GND and analog GND. Noise currents in the output power stage need to be returned to output noise ground and nowhere else. When these currents circulate elsewhere, they may get into the power supply, or the signal ground, etc, even worse, they may form a loop and radiate noise. Any of these instances results in degraded amplifier performance. The output noise ground that the logical returns for the output noise currents associated with Class-D switching must tie to system ground at the power exclusively. Signal currents for the inputs, reference need to be returned to quiet ground. This ground only ties to the signal components and the GND pin. GND then ties to system ground.

#### Power Supply Line

Same as the ground,  $V_{DD}$  and  $PV_{DD}$  need to be separately connected to the system power supply. It is recommended that all the trace could be routed as short and thick as possible. For the power line layout, just imagine water stream, any barricade placed in the trace (shown in Figure 2) could result in the bad performance of the amplifier.

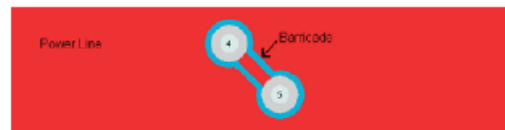

Figure 2. Power Line

#### Component Placement

Decoupling capacitors-As previously described, the high-frequency  $1\mu\text{F}$  decoupling capacitors should be placed as close to the power supply terminals ( $V_{DD}$  and  $PV_{DD}$ ) as possible. Large bulk power supply decoupling capacitors ( $10\mu\text{F}$  or greater) should be placed near the PAM8404 on the  $PV_{DD}$  terminal.

Input capacitors need to be placed very close to input pins.

Output filter - The ferrite EMI filter should be placed as close to the output terminals as possible for the best EMI performance, and the capacitors used in the filters should be grounded to system ground.

**Ordering Information**

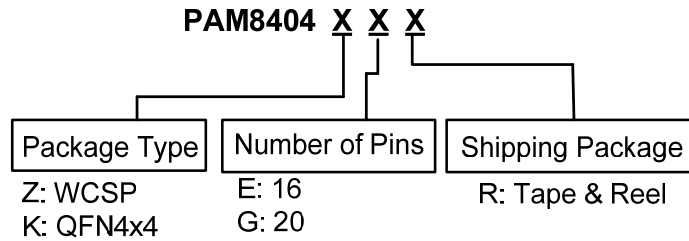

Part Number	Part Marking	Package Type	Standard Package
PAM8404ZER	FR YW	WCSP-16	3000 Units/Tape&Reel
PAM8404KGR	P8404 XXXYW	QFN4x4-20L	3000 Units/Tape&Reel

**Marking Information**

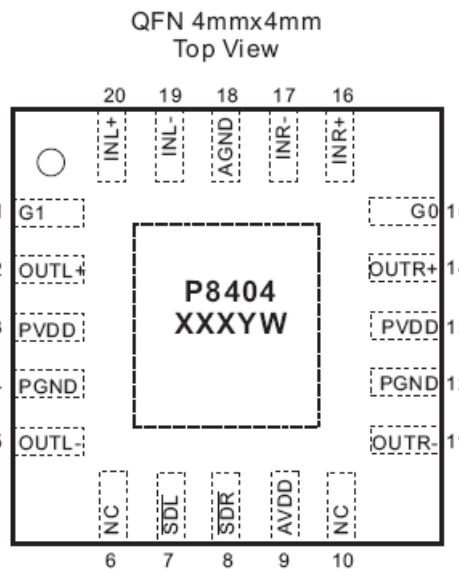
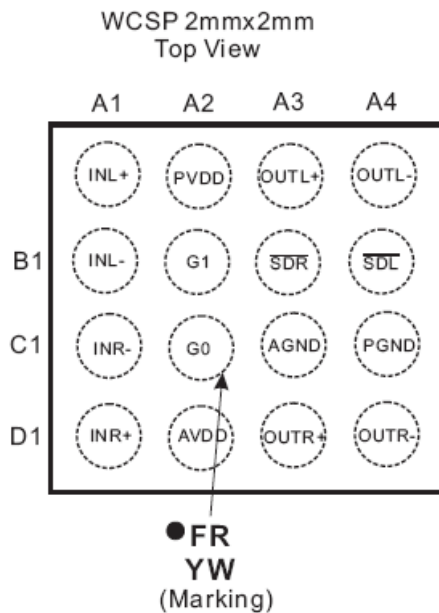

FR: Product Code of PAM8404  
X: Internal Code  
Y: Year  
W: Week

**Package Outline Dimensions** (All dimensions in mm.)

QFN4X4-20

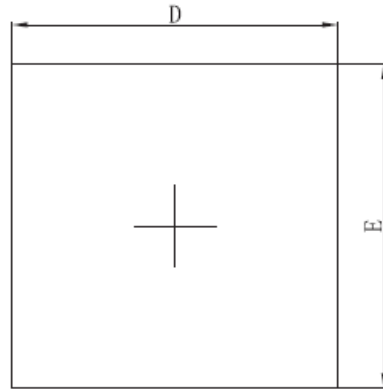

**Top View**

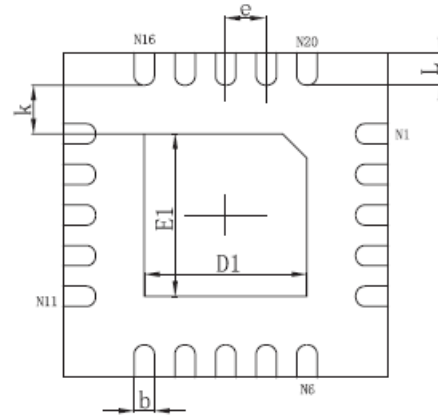

**Bottom View**

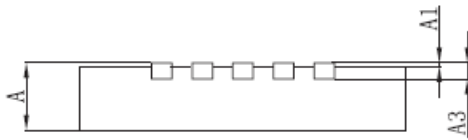

**Side View**

Symbol	Dimensions In Millimeters		Dimensions In Inches	
	Min.	Max.	Min.	Max.
A	0.700/0.800	0.800/0.900	0.028/0.031	0.031/0.035
A1	0.000	0.050	0.000	0.002
A3	0.203REF.		0.008REF.	
D	3.900	4.100	0.154	0.161
E	3.900	4.100	0.154	0.161
D1	1.900	2.100	0.075	0.083
E1	1.900	2.100	0.075	0.083
k	0.200MIN.		0.008MIN.	
b	0.180	0.300	0.007	0.012
e	0.500TYP.		0.020TYP.	
L	0.300	0.500	0.012	0.020

**Package Outline Dimensions** (cont.) (All dimensions in mm.)

WCSP2x2-16

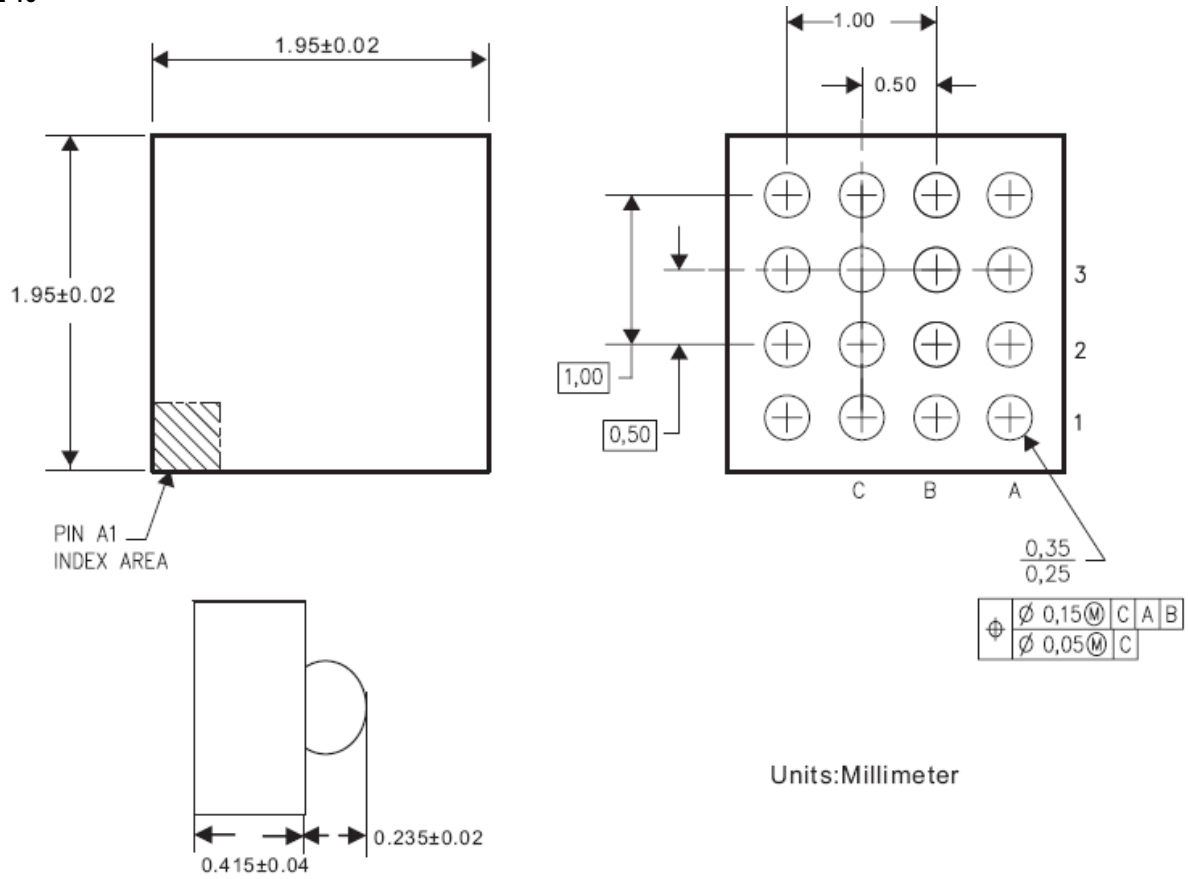

Units: Millimeter

**IMPORTANT NOTICE**

DIODES INCORPORATED MAKES NO WARRANTY OF ANY KIND, EXPRESS OR IMPLIED, WITH REGARDS TO THIS DOCUMENT, INCLUDING, BUT NOT LIMITED TO, THE IMPLIED WARRANTIES OF MERCHANTABILITY AND FITNESS FOR A PARTICULAR PURPOSE (AND THEIR EQUIVALENTS UNDER THE LAWS OF ANY JURISDICTION).

Diodes Incorporated and its subsidiaries reserve the right to make modifications, enhancements, improvements, corrections or other changes without further notice to this document and any product described herein. Diodes Incorporated does not assume any liability arising out of the application or use of this document or any product described herein; neither does Diodes Incorporated convey any license under its patent or trademark rights, nor the rights of others. Any Customer or user of this document or products described herein in such applications shall assume all risks of such use and will agree to hold Diodes Incorporated and all the companies whose products are represented on Diodes Incorporated website, harmless against all damages.

Diodes Incorporated does not warrant or accept any liability whatsoever in respect of any products purchased through unauthorized sales channel. Should Customers purchase or use Diodes Incorporated products for any unintended or unauthorized application, Customers shall indemnify and hold Diodes Incorporated and its representatives harmless against all claims, damages, expenses, and attorney fees arising out of, directly or indirectly, any claim of personal injury or death associated with such unintended or unauthorized application.

Products described herein may be covered by one or more United States, international or foreign patents pending. Product names and markings noted herein may also be covered by one or more United States, international or foreign trademarks.

This document is written in English but may be translated into multiple languages for reference. Only the English version of this document is the final and determinative format released by Diodes Incorporated.

**LIFE SUPPORT**

Diodes Incorporated products are specifically not authorized for use as critical components in life support devices or systems without the express written approval of the Chief Executive Officer of Diodes Incorporated. As used herein:

A. Life support devices or systems are devices or systems which:

1. are intended to implant into the body, or
2. support or sustain life and whose failure to perform when properly used in accordance with instructions for use provided in the labeling can be reasonably expected to result in significant injury to the user.

B. A critical component is any component in a life support device or system whose failure to perform can be reasonably expected to cause the failure of the life support device or to affect its safety or effectiveness.

Customers represent that they have all necessary expertise in the safety and regulatory ramifications of their life support devices or systems, and acknowledge and agree that they are solely responsible for all legal, regulatory and safety-related requirements concerning their products and any use of Diodes Incorporated products in such safety-critical, life support devices or systems, notwithstanding any devices- or systems-related information or support that may be provided by Diodes Incorporated. Further, Customers must fully indemnify Diodes Incorporated and its representatives against any damages arising out of the use of Diodes Incorporated products in such safety-critical, life support devices or systems.

Copyright © 2012, Diodes Incorporated

[www.diodes.com](http://www.diodes.com)

## Looking for pricing, stock, or lifecycle information?

Click below to explore more details on WIN SOURCE:

-  [View PAM8404KGR on WIN SOURCE](#)
-  [Diodes Incorporated Information](#)

## Optimize Your Supply Chain with WIN SOURCE Solutions

-  Global Sourcing Solution
-  Obsolete Management
-  Cost Control Management
-  Shortage Management
-  Alternative Solution
-  Excess Inventory Management