



**THE DATASHEET OF
PACDN046M**



PACDN042

ESD Protection Diode Low Clamping Voltage



ON Semiconductor®

www.onsemi.com

Product Description

The PACDN042/43/44/45/46 family of surge protection arrays provide a very high level of protection for sensitive electronic components that may be subjected to electrostatic discharge (ESD). The PACDN042/43/44/45/46 devices safely dissipate ESD strikes, exceeding the IEC 61000-4-2 International Standard, Level 4 (± 8 kV contact discharge). All pins are rated to withstand ± 20 kV ESD pulses using the IEC 61000-4-2 contact discharge method. Using the MIL-STD-883D (Method 3015) specification for Human Body Model (HBM) ESD, all pins are protected from contact discharges of greater than ± 30 kV.

Features

- Two, Three, Four, Five, or Six surge protection
- Compact SMT Package Saves Board Space and Facilitates Layout in Space-Critical Applications
- In-System ESD Protection to ± 20 kV Contact Discharge, per the IEC 61000-4-2 International Standard
- These Devices are Pb-Free and are RoHS Compliant

Applications

- ESD Protection of PC Ports, Including USB Ports, Serial Ports, Parallel Ports, IEEE1394 Ports, Docking Ports, Proprietary Ports, etc.
- Protection of Interface Ports or IC Pins which are Exposed to High ESD Levels



SOT-23-3
CASE 318

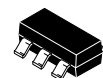

SOT-23-5
CASE 527AH

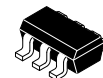

SOT-23-6
CASE 527AJ



SOT-143
CASE 527AF



SC70-3
CASE 419AB

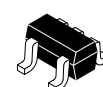

CS70-5
CASE 419AC



SC70-6
CASE 419AD

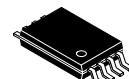

TSSOP8
CASE 948AL

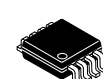

MSOP8
CASE 846AB

MARKING DIAGRAM

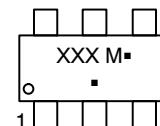

XXX = Specific Device Code
M = Date Code
■ = Pb-Free Package

(Note: Microdot may be in either location)

ORDERING INFORMATION

(see the last page of this document)

PACDN042

ELECTRICAL SCHEMATIC

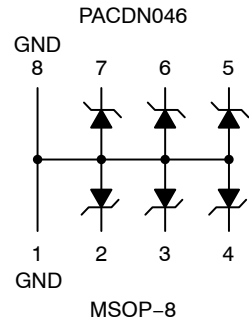
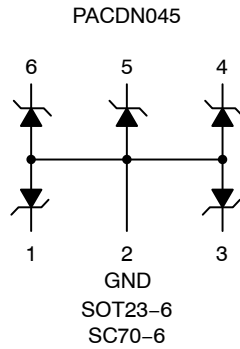
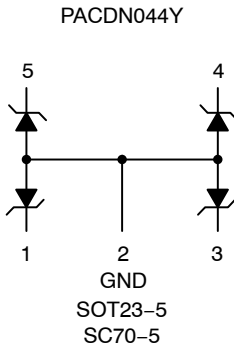
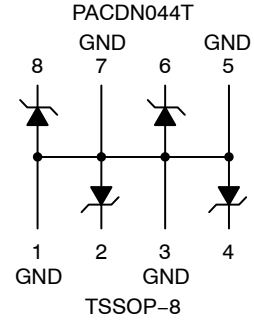
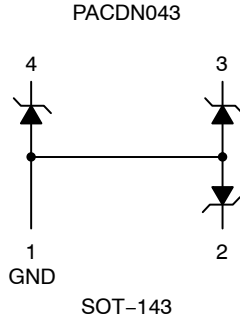
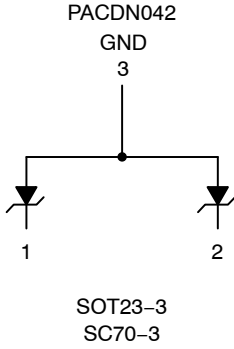

PACKAGE / PINOUT DIAGRAMS

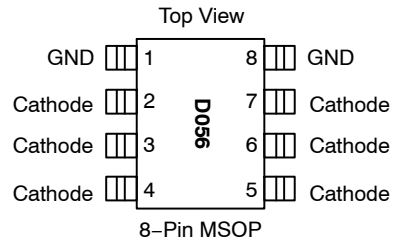
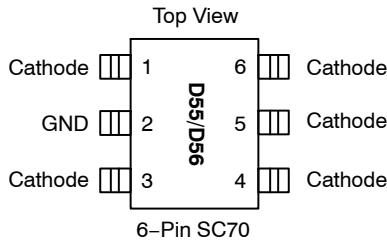
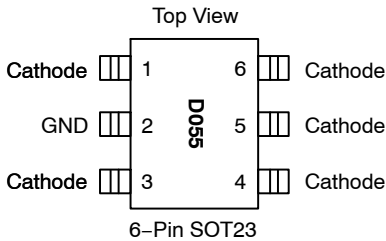
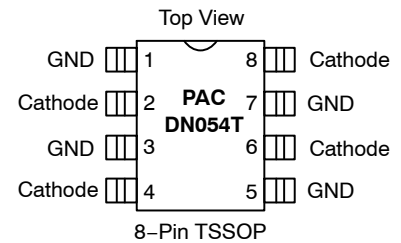
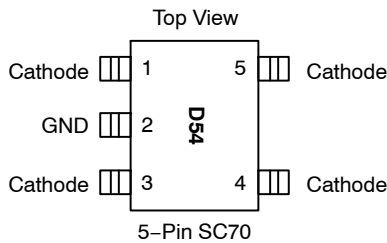
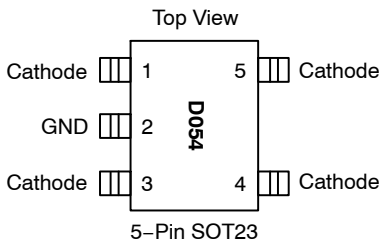
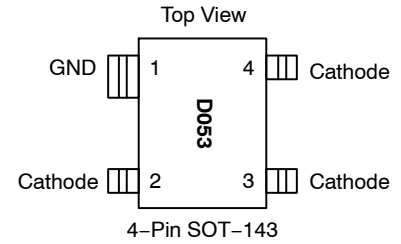
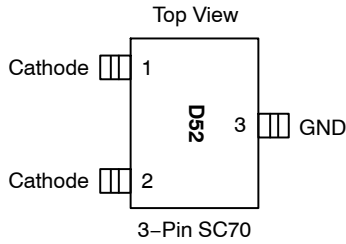
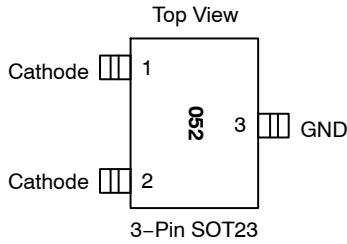

Note: SOT23, SC70, SOT-143, TSSOP, and MSOP Packages may differ in size. These drawings are not to scale.

PACDN042

Table 1. PIN DESCRIPTIONS

Pins	Name	Description
(Refer to Package Outline Drawings)	Cathode	The cathode of the respective surge protection diode, which should be connected to the node requiring transient voltage protection.
(Refer to Package Outline Drawings)	GND	The anode of the surge protection diodes.

SPECIFICATIONS

Table 2. ABSOLUTE MAXIMUM RATINGS

Parameter	Rating	Units
Storage Temperature Range	-65 to +150	°C
Package Power Dissipation SC70 SOT23-3, SOT23-5, SOT23-6, SOT-143 TSSOP, MSOP	0.2 0.225 0.5	W

Stresses exceeding those listed in the Maximum Ratings table may damage the device. If any of these limits are exceeded, device functionality should not be assumed, damage may occur and reliability may be affected.

Table 3. STANDARD OPERATING CONDITIONS

Parameter	Rating	Units
Operating Temperature	-40 to +85	°C

Table 4. ELECTRICAL OPERATING CHARACTERISTICS

Symbol	Parameter	Conditions	Min	Typ	Max	Units
C	Capacitance	$T_A = 25^\circ\text{C}$, 2.5 VDC, 1 MHz		30		pF
V_{RSO}	Reverse Stand-off Voltage	$I_R = 10\ \mu\text{A}$, $T_A = 25^\circ\text{C}$	5.5			V
		$I_R = 1\ \text{mA}$, $T_A = 25^\circ\text{C}$	6.1			V
I_{LEAK}	Leakage Current	$V_{\text{IN}} = 5.0\ \text{VDC}$, $T_A = 25^\circ\text{C}$		1	100	nA
V_{SIG}	Small Signal Clamp Voltage Positive Clamp Negative Clamp	$I = 10\ \text{mA}$, $T_A = 25^\circ\text{C}$ $I = -10\ \text{mA}$, $T_A = 25^\circ\text{C}$	6.2 -0.4	6.8 -0.8	8 -1.2	V
V_{ESD}	ESD Withstand Voltage Human Body Model, MIL-STD-883, Method 3015 Contact Discharge per IEC 61000-4-2 Standard	(Note 1) (Note 1)	± 30 ± 20			kV
R_D	Diode Dynamic Resistance Forward Conduction Reverse Conduction			1.0 1.4		Ω

Product parametric performance is indicated in the Electrical Characteristics for the listed test conditions, unless otherwise noted. Product performance may not be indicated by the Electrical Characteristics if operated under different conditions.

1. ESD voltage applied between channel pins & ground, one pin at a time; all other channel pins open; all GND pins grounded.

PACDN042

PERFORMANCE INFORMATION

Diode Capacitance

Typical diode capacitance with respect to positive cathode voltage (reverse voltage across the diode) is given in Diode Capacitance vs. Reverse Voltage.

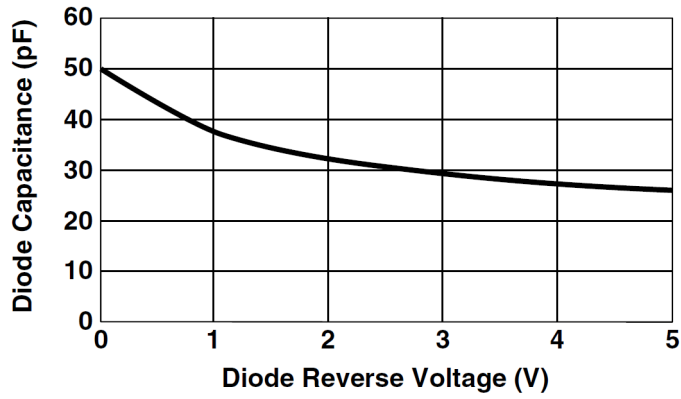

Figure 1. Diode Capacitance vs. Reverse Voltage

Typical High Current Diode Characteristics

Measurements are made in pulse mode with a nominal pulse width of 0.7 mS.

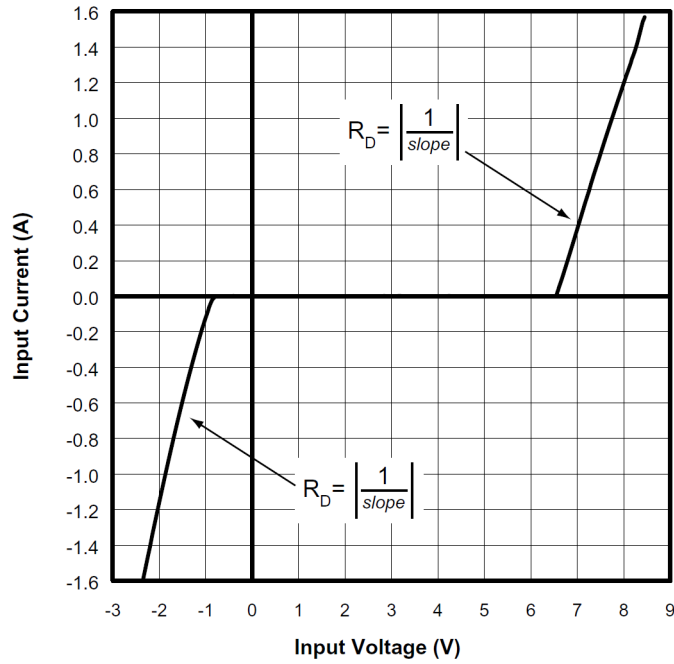
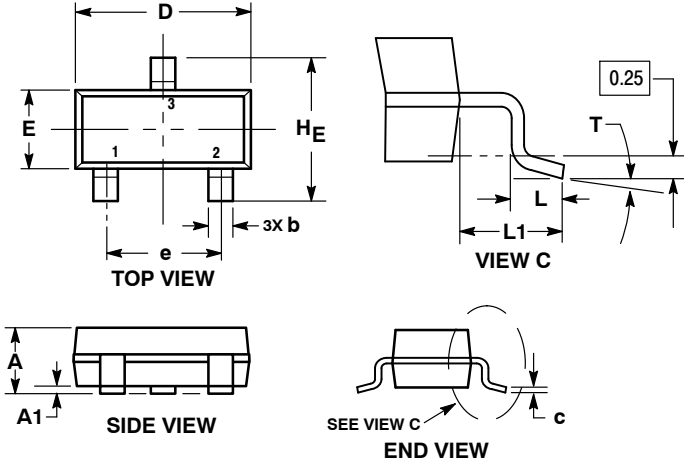

Figure 2. Typical Input VI Characteristics
(Pulse-mode measurements, pulse width = 0.7 mS nominal)

PACDN042

PACKAGE DIMENSIONS

SOT-23 (TO-236)
CASE 318-08
ISSUE AR



NOTES:

1. DIMENSIONING AND TOLERANCING PER ASME Y14.5M, 1994.
2. CONTROLLING DIMENSION: MILLIMETERS.
3. MAXIMUM LEAD THICKNESS INCLUDES LEAD FINISH. MINIMUM LEAD THICKNESS IS THE MINIMUM THICKNESS OF THE BASE MATERIAL.
4. DIMENSIONS D AND E DO NOT INCLUDE MOLD FLASH, PROTRUSIONS, OR GATE BURRS.

DIM	MILLIMETERS			INCHES		
	MIN	NOM	MAX	MIN	NOM	MAX
A	0.89	1.00	1.11	0.035	0.039	0.044
A1	0.01	0.06	0.10	0.000	0.002	0.004
b	0.37	0.44	0.50	0.015	0.017	0.020
c	0.08	0.14	0.20	0.003	0.006	0.008
D	2.80	2.90	3.04	0.110	0.114	0.120
E	1.20	1.30	1.40	0.047	0.051	0.055
e	1.78	1.90	2.04	0.070	0.075	0.080
L	0.30	0.43	0.55	0.012	0.017	0.022
L1	0.35	0.54	0.69	0.014	0.021	0.027
HE	2.10	2.40	2.64	0.083	0.094	0.104
T	0°	---	10°	0°	---	10°

RECOMMENDED SOLDERING FOOTPRINT*

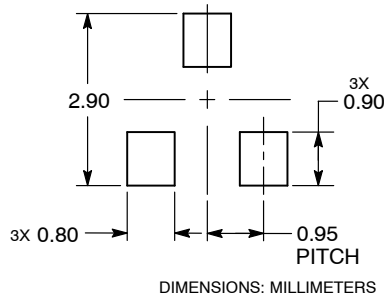

*For additional information on our Pb-Free strategy and soldering details, please download the ON Semiconductor Soldering and Mounting Techniques Reference Manual, SOLDERRM/D.

PACDN042

PACKAGE DIMENSIONS

SOT-23, 5 Lead
CASE 527AH
ISSUE O

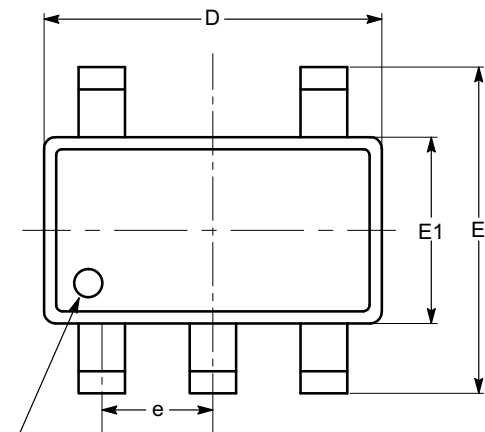

PIN #1 IDENTIFICATION

TOP VIEW

SYMBOL	MIN	NOM	MAX
A	0.90		1.45
A1	0.00		0.15
A2	0.90	1.15	1.30
b	0.30		0.50
c	0.08		0.22
D	2.90 BSC		
E	2.80 BSC		
E1	1.60 BSC		
e	0.95 BSC		
L	0.30	0.45	0.60
L1	0.60 REF		
L2	0.25 REF		
θ	0°	4°	8°
$\theta 1$	5°	10°	15°
$\theta 2$	5°	10°	15°

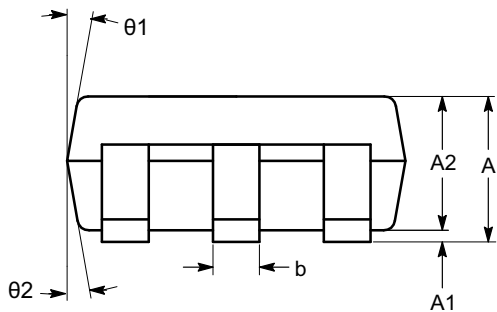

SIDE VIEW

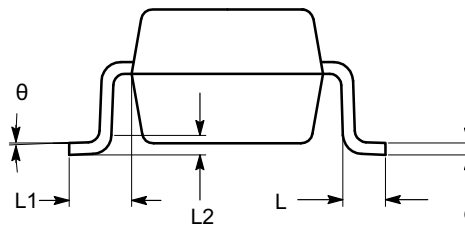

END VIEW

Notes:

- (1) All dimensions in millimeters. Angles in degrees.
- (2) Complies with JEDEC standard MO-178.

PACDN042

PACKAGE DIMENSIONS

SOT-23, 6 Lead
CASE 527AJ
ISSUE B

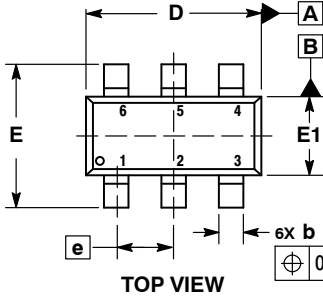

\oplus	0.20	M	C	A	S	B	S
----------	------	---	---	---	---	---	---

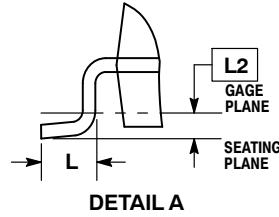

- NOTES:
1. DIMENSIONING AND TOLERANCING PER ASME Y14.5M, 1994.
 2. CONTROLLING DIMENSION: MILLIMETERS.
 3. DATUM C IS THE SEATING PLANE.

MILLIMETERS		
DIM	MIN	MAX
A	---	1.45
A1	0.00	0.15
A2	0.90	1.30
b	0.20	0.50
c	0.08	0.26
D	2.70	3.00
E	2.50	3.10
E1	1.30	1.80
e	0.95 BSC	
L	0.20	0.60
L2	0.25 BSC	

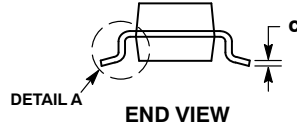
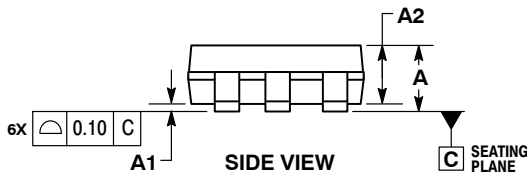

RECOMMENDED SOLDERING FOOTPRINT*

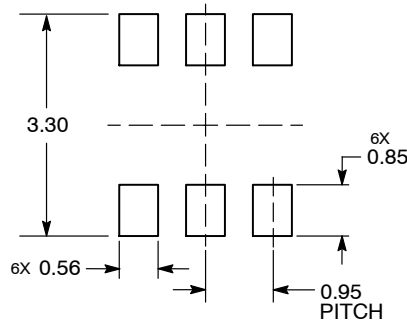

DIMENSIONS: MILLIMETERS

*For additional information on our Pb-Free strategy and soldering details, please download the ON Semiconductor Soldering and Mounting Techniques Reference Manual, SOLDERRM/D.

PACDN042

PACKAGE DIMENSIONS

SOT-143, 4 Lead
CASE 527AF
ISSUE A

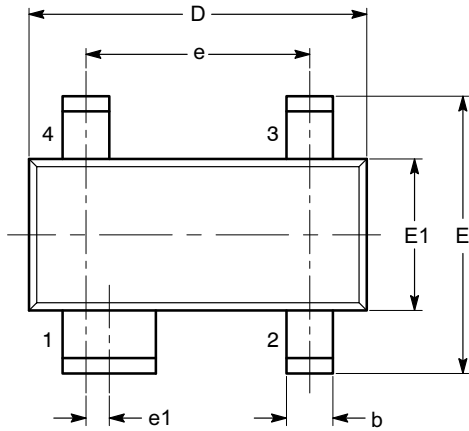

TOP VIEW

SYMBOL	MIN	NOM	MAX
A	0.80		1.22
A1	0.05		0.15
A2	0.75	0.90	1.07
b	0.30		0.50
b2	0.76		0.89
c	0.08		0.20
D	2.80	2.90	3.04
E	2.10		2.64
E1	1.20	1.30	1.40
e	1.92 BSC		
e1	0.20 BSC		
L	0.40	0.50	0.60
L1	0.54 REF		
L2		0.25	
θ	0°		8°

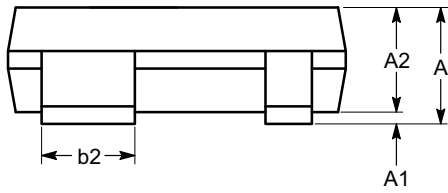

SIDE VIEW

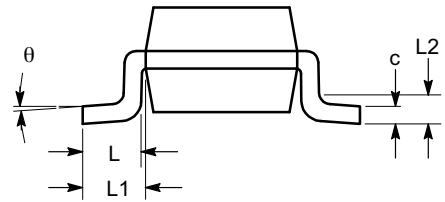

END VIEW

Notes:

- (1) All dimensions are in millimeters. Angles in degrees.
- (2) Complies with JEDEC TO-253.

PACDN042

PACKAGE DIMENSIONS

SC-70, 3 Lead, 1.25x2
CASE 419AB
ISSUE O

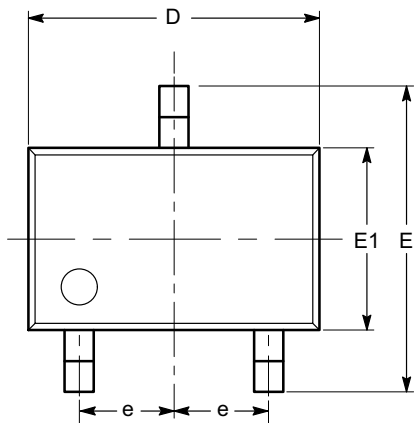

TOP VIEW

SYMBOL	MIN	NOM	MAX
A	0.80		1.10
A1	0.00		0.10
A2	0.80	0.90	1.00
b	0.15		0.30
c	0.08		0.22
D	1.80	2.00	2.20
E	1.80	2.10	2.40
E1	1.15	1.25	1.35
e	0.65 BSC		
L	0.26	0.36	0.46
L1	0.42 REF		
L2	0.15 BSC		
θ	0°		8°
θ_1	4°		10°

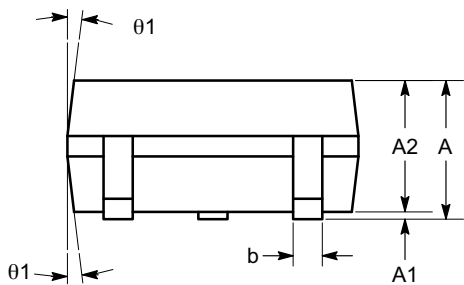

SIDE VIEW

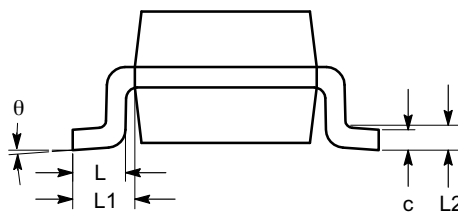

END VIEW

Notes:

- (1) All dimensions are in millimeters. Angles in degrees.
- (2) Complies with JEDEC MO-203.

PACDN042

PACKAGE DIMENSIONS

SC-88A (SC-70 5 Lead), 1.25x2
CASE 419AC
ISSUE A

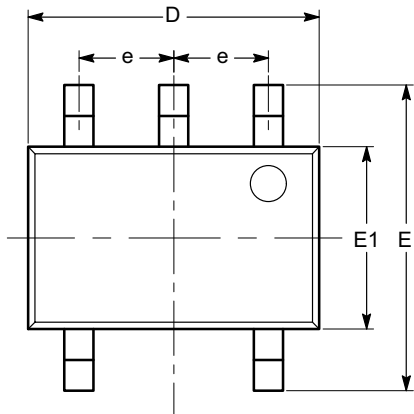

TOP VIEW

SYMBOL	MIN	NOM	MAX
A	0.80		1.10
A1	0.00		0.10
A2	0.80		1.00
b	0.15		0.30
c	0.10		0.18
D	1.80	2.00	2.20
E	1.80	2.10	2.40
E1	1.15	1.25	1.35
e	0.65 BSC		
L	0.26	0.36	0.46
L1	0.42 REF		
L2	0.15 BSC		
θ	0°		8°
θ_1	4°		10°

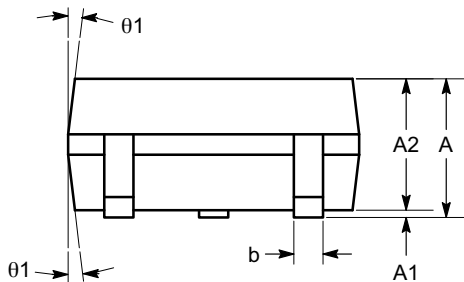

SIDE VIEW

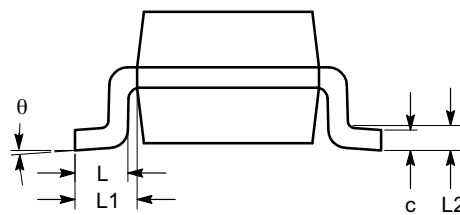

END VIEW

Notes:

- (1) All dimensions are in millimeters. Angles in degrees.
- (2) Complies with JEDEC MO-203.

PACDN042

PACKAGE DIMENSIONS

SC-88 (SC-70 6 Lead), 1.25x2
CASE 419AD
ISSUE A

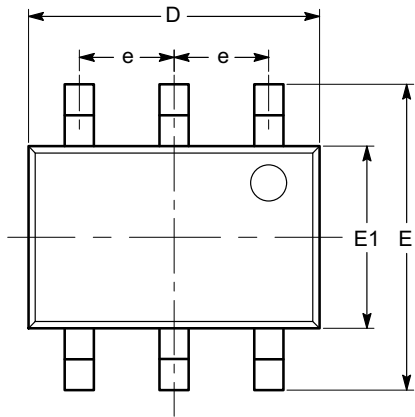

TOP VIEW

SYMBOL	MIN	NOM	MAX
A	0.80		1.10
A1	0.00		0.10
A2	0.80		1.00
b	0.15		0.30
c	0.10		0.18
D	1.80	2.00	2.20
E	1.80	2.10	2.40
E1	1.15	1.25	1.35
e	0.65 BSC		
L	0.26	0.36	0.46
L1	0.42 REF		
L2	0.15 BSC		
θ	0°		8°
θ_1	4°		10°

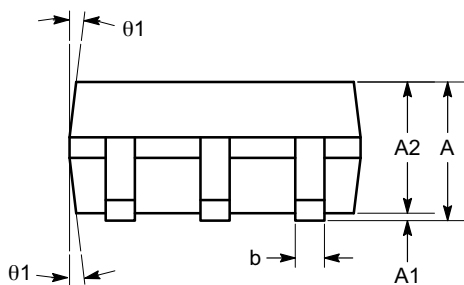

SIDE VIEW

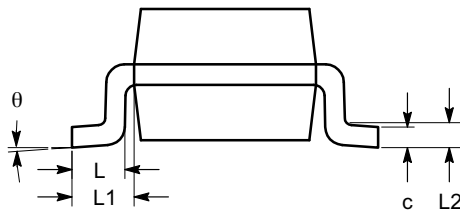

END VIEW

Notes:

- (1) All dimensions are in millimeters. Angles in degrees.
- (2) Complies with JEDEC MO-203.

PACDN042

PACKAGE DIMENSIONS

TSSOP8, 4.4x3
CASE 948AL
ISSUE O

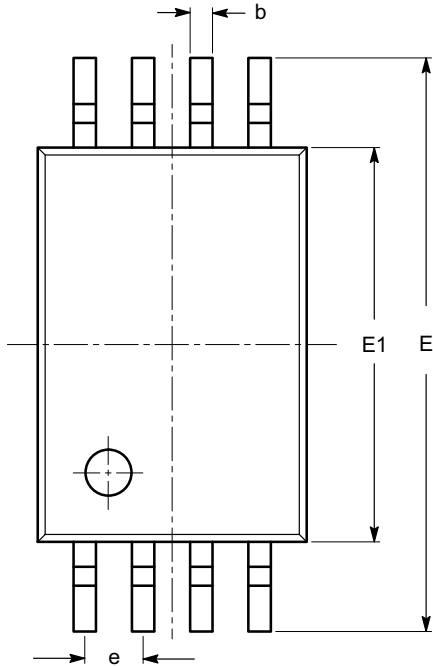

SYMBOL	MIN	NOM	MAX
A			1.20
A1	0.05		0.15
A2	0.80	0.90	1.05
b	0.19		0.30
c	0.09		0.20
D	2.90	3.00	3.10
E	6.30	6.40	6.50
E1	4.30	4.40	4.50
e	0.65 BSC		
L	1.00 REF		
L1	0.50	0.60	0.75
θ	0°		8°

TOP VIEW

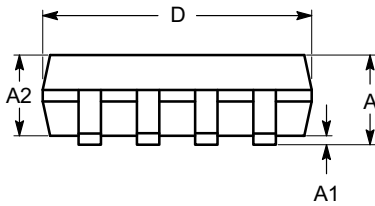

SIDE VIEW

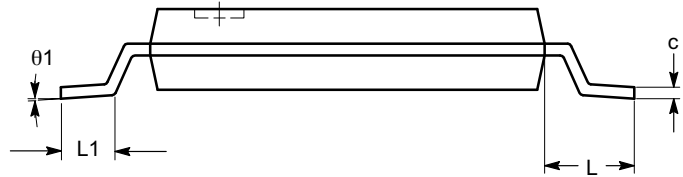

END VIEW

Notes:

- (1) All dimensions are in millimeters. Angles in degrees.
- (2) Complies with JEDEC MO-153.

PACDN042

PACKAGE DIMENSIONS

MSOP8 CASE 846AB ISSUE O

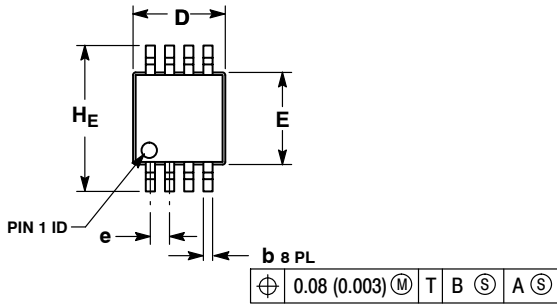

NOTES:

1. DIMENSIONING AND TOLERANCING PER ANSI Y14.5M, 1982.
2. CONTROLLING DIMENSION: MILLIMETER.
3. DIMENSION A DOES NOT INCLUDE MOLD FLASH, PROTRUSIONS OR GATE BURRS. MOLD FLASH, PROTRUSIONS OR GATE BURRS SHALL NOT EXCEED 0.15 (0.006) PER SIDE.
4. DIMENSION B DOES NOT INCLUDE INTERLEAD FLASH OR PROTRUSION. INTERLEAD FLASH OR PROTRUSION SHALL NOT EXCEED 0.25 (0.010) PER SIDE.
5. 846A-01 OBSOLETE, NEW STANDARD 846A-02.

DIM	MILLIMETERS			INCHES		
	MIN	NOM	MAX	MIN	NOM	MAX
A	---	---	1.10	---	---	0.043
A1	0.05	0.08	0.15	0.002	0.003	0.006
b	0.25	0.33	0.40	0.010	0.013	0.016
c	0.13	0.18	0.23	0.005	0.007	0.009
D	2.90	3.00	3.10	0.114	0.118	0.122
E	2.90	3.00	3.10	0.114	0.118	0.122
e	0.65 BSC			0.026 BSC		
L	0.40	0.55	0.70	0.016	0.021	0.028
HE	4.75	4.90	5.05	0.187	0.193	0.199

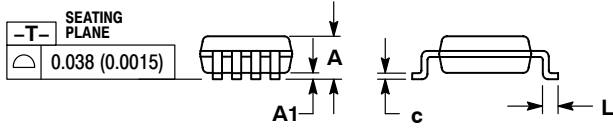

SOLDERING FOOTPRINT*

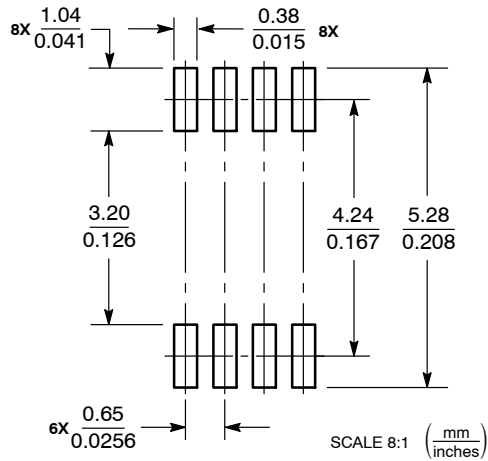

*For additional information on our Pb-Free strategy and soldering details, please download the ON Semiconductor Soldering and Mounting Techniques Reference Manual, SOLDERRM/D.

PACDN042

ORDERING INFORMATION

Device	Package	Shipping
PACDN042Y3R	SOT23-3 (Pb-Free)	3000/Tape & Reel
PACDN044Y5R	SOT23-5 (Pb-Free)	3000/Tape & Reel
PACDN045Y6R	SOT23-6 (Pb-Free)	3000/Tape & Reel
PACDN043Y4R	SOT-143 (Pb-Free)	3000/Tape & Reel
PACDN042YB3R	SC70-3 (Pb-Free)	3000/Tape & Reel

ORDERING INFORMATION (cont'd)

Device	Package	Shipping
PACDN044YB5R	SC70-5 (Pb-Free)	3000/Tape & Reel
PACDN045YB6R	SC70-6 (Pb-Free)	3000/Tape & Reel
PACDN045YB6R-R	SC70-6 (Pb-Free)	3000/Tape & Reel
PACDN044TR	TSSOP8 (Pb-Free)	2500/Tape & Reel
PACDN046MR	MSOP8 (Pb-Free)	4000/Tape & Reel

ON Semiconductor and  are trademarks of Semiconductor Components Industries, LLC dba ON Semiconductor or its subsidiaries in the United States and/or other countries. ON Semiconductor owns the rights to a number of patents, trademarks, copyrights, trade secrets, and other intellectual property. A listing of ON Semiconductor's product/patent coverage may be accessed at www.onsemi.com/site/pdf/Patent-Marking.pdf. ON Semiconductor reserves the right to make changes without further notice to any products herein. ON Semiconductor makes no warranty, representation or guarantee regarding the suitability of its products for any particular purpose, nor does ON Semiconductor assume any liability arising out of the application or use of any product or circuit, and specifically disclaims any and all liability, including without limitation special, consequential or incidental damages. Buyer is responsible for its products and applications using ON Semiconductor products, including compliance with all laws, regulations and safety requirements or standards, regardless of any support or applications information provided by ON Semiconductor. "Typical" parameters which may be provided in ON Semiconductor data sheets and/or specifications can and do vary in different applications and actual performance may vary over time. All operating parameters, including "Typicals" must be validated for each customer application by customer's technical experts. ON Semiconductor does not convey any license under its patent rights nor the rights of others. ON Semiconductor products are not designed, intended, or authorized for use as a critical component in life support systems or any FDA Class 3 medical devices or medical devices with a same or similar classification in a foreign jurisdiction or any devices intended for implantation in the human body. Should Buyer purchase or use ON Semiconductor products for any such unintended or unauthorized application, Buyer shall indemnify and hold ON Semiconductor and its officers, employees, subsidiaries, affiliates, and distributors harmless against all claims, costs, damages, and expenses, and reasonable attorney fees arising out of, directly or indirectly, any claim of personal injury or death associated with such unintended or unauthorized use, even if such claim alleges that ON Semiconductor was negligent regarding the design or manufacture of the part. ON Semiconductor is an Equal Opportunity/Affirmative Action Employer. This literature is subject to all applicable copyright laws and is not for resale in any manner.

PUBLICATION ORDERING INFORMATION

LITERATURE FULFILLMENT:

Literature Distribution Center for ON Semiconductor
19521 E. 32nd Pkwy, Aurora, Colorado 80011 USA
Phone: 303-675-2175 or 800-344-3860 Toll Free USA/Canada
Fax: 303-675-2176 or 800-344-3867 Toll Free USA/Canada
Email: orderlit@onsemi.com

N. American Technical Support: 800-282-9855 Toll Free
USA/Canada
Europe, Middle East and Africa Technical Support:
Phone: 421 33 790 2910
Japan Customer Focus Center
Phone: 81-3-5817-1050

ON Semiconductor Website: www.onsemi.com
Order Literature: <http://www.onsemi.com/orderlit>

For additional information, please contact your local Sales Representative

Looking for pricing, stock, or lifecycle information?

Click below to explore more details on WIN SOURCE:

 [View PACDN046M](#) on WIN SOURCE

 [ON Semiconductor](#) Information

Optimize Your Supply Chain with WIN SOURCE Solutions

-  Global Sourcing Solution
-  Obsolete Management
-  Cost Control Management
-  Shortage Management
-  Alternative Solution
-  Excess Inventory Management