

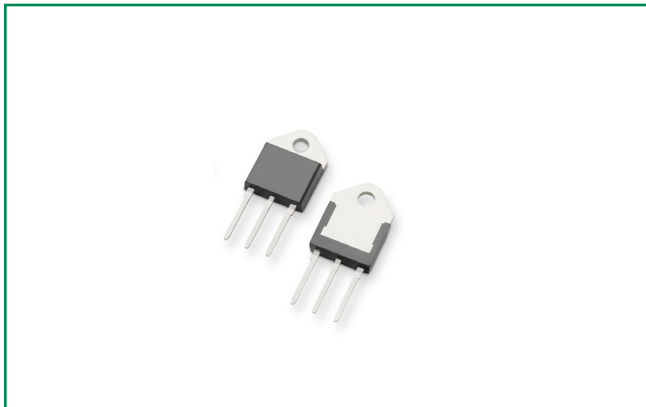

THE DATASHEET OF P1500MEL



Pxxx0ME 5kA SIDACtor Series in TO-218



Description

The 5kA series SIDACtor® components are designed to protect equipment located in high exposure environments from severe overvoltage transients.

Set up in a robust TO-218 package, the 5kA series are ideal for use in data interface and AC power line for CATV amplifiers, Telecom Base Station equipment and Cell Towers.

Features and Benefits

- Low voltage overshoot
- Low on-state voltage
- Surge capability does not degrade after multiple surge events within its limits
- Fails to short circuit mode when it is surged beyond its ratings
- Rugged TO-218 package
- 5000A 8/20 μs surge rating
- 2nd level interconnect is Pb-free per IPC/JEDEC J-STD-609A
- RoHS compliant, lead-free and halogen-free

Agency Approvals

Agency	Agency File Number
	E133083

Pinout Designation

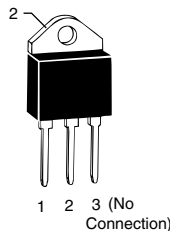

Applicable Global Standards

- TIA-968-A
- TIA-968-B
- ITU K.20/.21/.45 Enhanced Level
- ITU K.20/.21/.45 Basic Level
- GR 1089 Inter-building
- GR 1089 Intra-building
- IEC 61000-4-5 2nd Edition
- YD/T 1082
- YD/T 993
- YD/T 950

Schematic Symbol



Additional Information



Datasheet



Resources



Samples

Electrical Characteristics

Part Number	Marking	V_{DRM} @ $I_{DRM}=5\mu A$	V_s @ 100V/μs	I_H	I_s	I_T	V_T @ $I_T=2.2 A$	Capacitance @ 1MHz, 2V bias	
		V min	V max	mA min	mA max	A max	V max	pF min	pF max
P1500MEL	P1500ME	140	180	50	800	2.2/25	4	400	650
P1900MEL	P1900ME	155	220	50	800	2.2/25	4	400	650
P2300MEL	P2300ME	180	260	50	800	2.2/25	4	350	600
P3800MEL	P3800ME	350	430	50	800	2.2/25	4	300	500
P4800MEL	P4800ME	450	600	20	800	2.2/25	4	300	500

Notes:
 - Absolute maximum ratings measured at T= 25°C (unless otherwise noted).
 - Components are bi-directional (unless otherwise noted).
 - I_s is a free air rating and heat sink is at 25A

Surge Ratings

Series	I_{PP}			I_{TSM} 50 / 60 Hz	di/dt
	8/20 ¹ - 1.2/50 ²	10/350 ¹ - 10/350 ²	10/1000 ¹ - 10/1000 ²		
	A min			A min	A/ μ s max
E	5000 ²	1500	1100	400	630

Notes:

- Waveform in μ s
 - For surge rating of P3800MEL, it is minimum 4kA and typical 5kA @8/20 μ s.
- Peak pulse current (I_{pp}) is repetitive and guaranteed for the life of the product.
 - The component must initially be in thermal equilibrium with $-40^{\circ}\text{C} \leq T_J \leq +150^{\circ}\text{C}$

Thermal Conditions

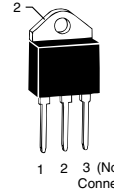
Package	Symbol	Parameter	Value	Unit
 <p>TO-218 1 2 3 (No Connection)</p>	T_{JO}	Operating Junction Temperature Range	-40 to +150	$^{\circ}\text{C}$
	T_S	Storage Temperature Range	-65 to +150	$^{\circ}\text{C}$
	T_C	Maximum Case Temperature	100	$^{\circ}\text{C}$
	$R_{\theta JC}^*$	Thermal Resistance: Junction to Case	1.7	$^{\circ}\text{C}/\text{W}$
	$R_{\theta JA}$	Thermal Resistance: Junction to Ambient	56	$^{\circ}\text{C}/\text{W}$

* $R_{\theta JC}$ rating assumes the use of a heat sink and on state mode for extended time at 25 A, with average power dissipation of 29 W.

V-I Characteristics

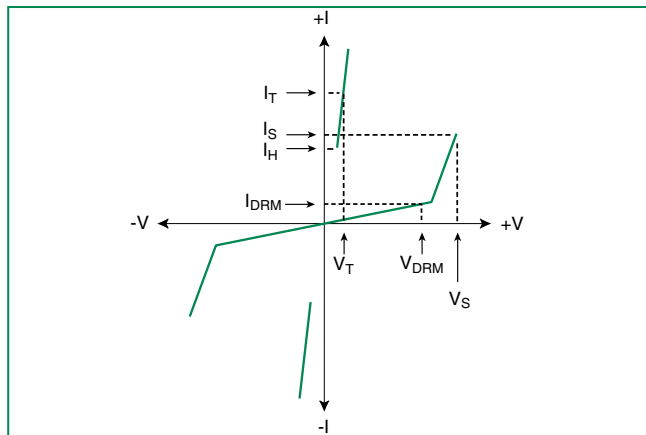

$t_r \times t_d$ Pulse Waveform

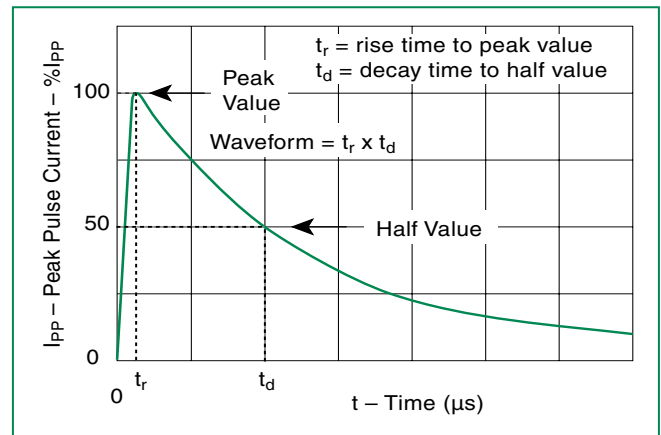

Normalized V_S Change vs. Junction Temperature

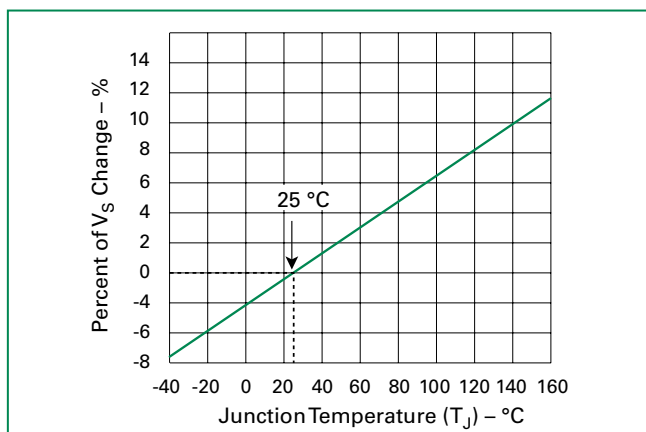

Normalized DC Holding Current vs. Case Temperature

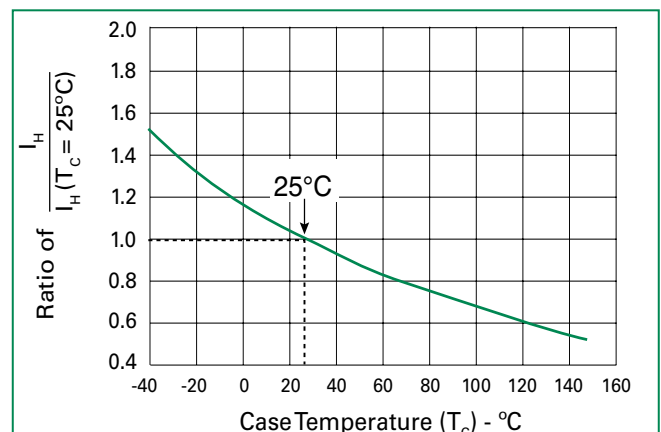

Soldering Parameters

Reflow Condition		Pb-Free assembly (see Fig. 1)
Pre Heat	-Temperature Min ($T_{s(min)}$)	+150°C
	-Temperature Max ($T_{s(max)}$)	+200°C
	-Time (Min to Max) (t_s)	60-180 secs.
Average ramp up rate (Liquidus Temp (T_L) to peak)		3°C/sec. Max.
$T_{s(max)}$ to T_L - Ramp-up Rate		3°C/sec. Max.
Reflow	-Temperature (T_L) (Liquidus)	+217°C
	-Temperature (t_L)	60-150 secs.
Peak Temp (T_p)		+260(+0/-5)°C
Time within 5°C of actual Peak Temp (t_p)		30 secs. Max.
Ramp-down Rate		6°C/sec. Max.
Time 25°C to Peak Temp (T_p)		8 min. Max.
Do not exceed		+260°C

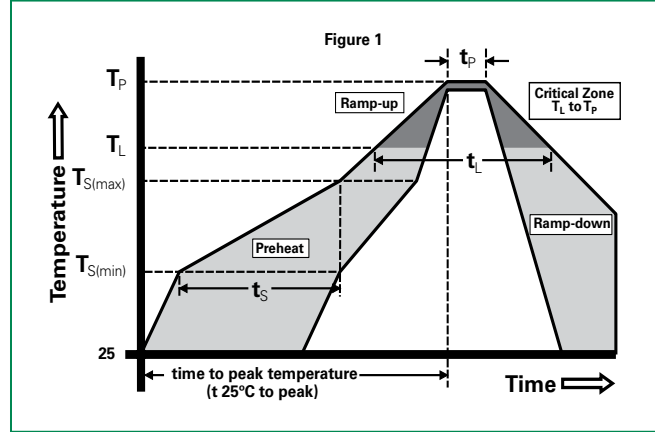

Physical Specifications

Lead Material	Copper Alloy
Terminal Finish	100% Matte-Tin Plated
Body Material	UL recognized epoxy meeting flammability classification V-0

Environmental Specifications

High Temp Voltage Blocking	80% Rated V_{DRM} ($V_{AC Peak}$) +125°C or +150°C, 504 or 1008 hrs. MIL-STD-750 (Method 1040) JEDEC, JESD22-A-101
Temp Cycling	-65°C to +150°C, 15 min. dwell, 10 up to 100 cycles. MIL-STD-750 (Method 1051) EIA/JEDEC, JESD22-A104
Biased Temp & Humidity	52 V_{DC} (+85°C) 85%RH, 504 up to 1008 hrs. EIA/JEDEC, JESD22-A-101
High Temp Storage	+150°C 1008 hrs. MIL-STD-750 (Method 1031) JEDEC, JESD22-A-101
Low Temp Storage	-65°C, 1008 hrs.
Thermal Shock	0°C to +100°C, 5 min. dwell, 10 sec. transfer, 10 cycles. MIL-STD-750 (Method 1056) JEDEC, JESD22-A-106
Autoclave (Pressure Cooker Test)	+121°C, 100%RH, 2atm, 24 up to 168 hrs. EIA/JEDEC, JESD22-A-102
Resistance to Solder Heat	+260°C, 30 secs. MIL-STD-750 (Method 2031)
Moisture Sensitivity Level	85%RH, +85°C, 168 hrs., 3 reflow cycles (+260°C Peak). JEDEC-J-STD-020, Level 1

Part Numbering

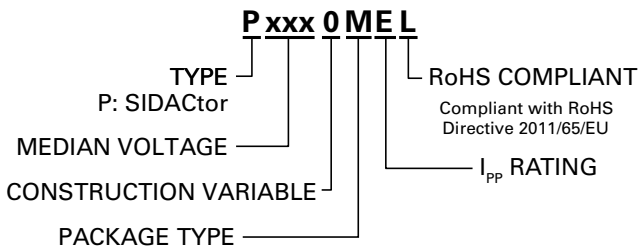

Part Marking

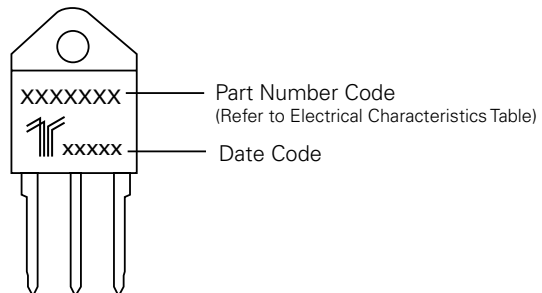

Dimensions – TO-218

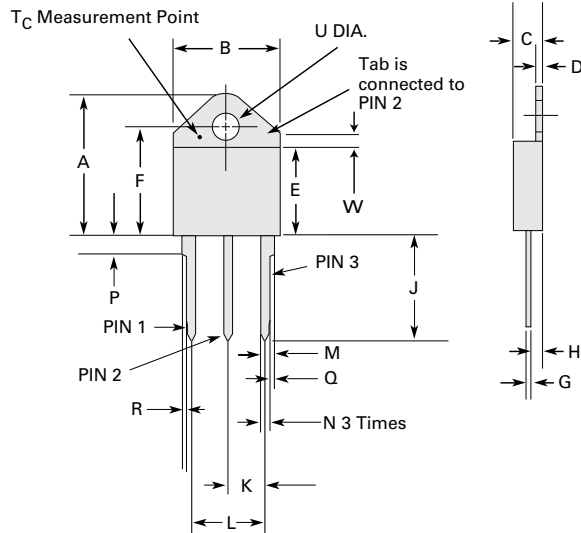

Dimensions	Inches		Millimeters	
	Min	Max	Min	Max
A	0.810	0.835	20.57	21.21
B	0.610	0.630	15.49	16.00
C	0.178	0.188	4.52	4.78
D	0.055	0.070	1.40	1.78
E	0.487	0.497	12.37	12.62
F	0.635	0.655	16.13	16.64
G	0.022	0.029	0.56	0.74
H	0.075	0.095	1.91	2.41
J	0.575	0.625	14.61	15.88
K	0.211	0.219	5.36	5.56
L	0.422	0.437	10.72	11.10
M	0.058	0.068	1.47	6.73
N	0.045	0.055	1.14	1.40
P	0.095	0.115	2.41	2.92
R	0.008	0.016	0.20	0.41
U	0.161	0.165	4.1	4.2
W	0.085	0.095	2.17	2.42

- Notes:**
- Mold flash shall not exceed 0.13 mm per side.
 - Maximum torque to be applied to mounting tab is 8 in-lbs. (0.904 Nm).
 - Pin 3 has no connection.
 - Tab is non-isolated (connects to middle pin).

Packing Options

Package Type	Description	Packing Options Quantity	Added Suffix	Industry Standard
M	TO-218 (ME) Tube Pack	250(25 per tube/10 tubes per box)	N/A	N/A

Tube Pack Specification – TO-218

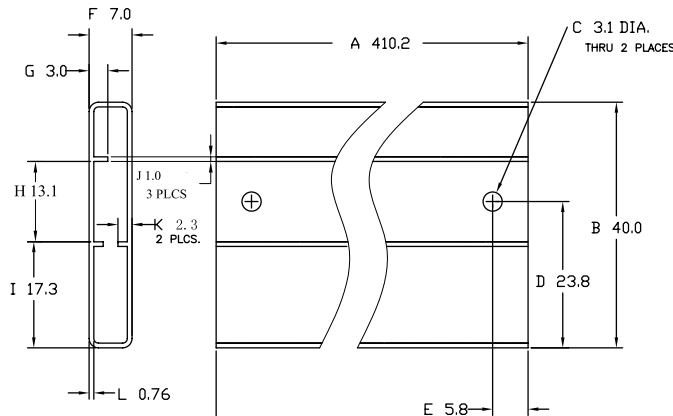

Disclaimer Notice - Information furnished is believed to be accurate and reliable. However, users should independently evaluate the suitability of and test each product selected for their own applications. Littelfuse products are not designed for, and may not be used in, all applications. Read complete Disclaimer Notice at www.littelfuse.com/disclaimer-electronics.

Looking for pricing, stock, or lifecycle information?

Click below to explore more details on WIN SOURCE:

 [View P1500MEL on WIN SOURCE](#)

 [Littelfuse Inc. Information](#)

Optimize Your Supply Chain with WIN SOURCE Solutions

-  Global Sourcing Solution
-  Obsolete Management
-  Cost Control Management
-  Shortage Management
-  Alternative Solution
-  Excess Inventory Management