



**THE DATASHEET OF  
P1100SDLRP**



**HF RoHS High Surge Current Series - DO-214**



**Agency Approvals**

Agency	Agency File Number
	E133083

**Pinout Designation**

Not Applicable

**Schematic Symbol**



**Description**

The High Surge Current DO-214 Series are SIDACTor® devices designed to protect equipment located in hostile environments from overvoltage transients.

The series provides a 200A 10/1000 μs rated surface mount solution that enables equipment to comply with enhanced surge requirements now specified in regulatory and customer requirements.

**Features and Benefits**

- Low voltage overshoot
- Low on-state voltage
- Does not degrade with use
- Fails short circuit when surged in excess of ratings
- 200A 10x1000 Surge Rating
- 1000A 2x10 Surge Rating

**Applicable Global Standards**

- TIA-968-A
- ITU K.20/21 Enhanced Level
- ITU K.20/21 Basic Level
- GR 1089 Inter-building
- GR 1089 Intra-building
- IEC 61000-4-5
- YD/T 1082
- YD/T 993
- YD/T 950

**Electrical Characteristics**

Part Number	Marking	$V_{DRM}$ @ $I_{DRM}=5\mu A$	$V_S$ @ 100V/μs	$I_H$	$I_S$	$I_{T+}$	$V_T$ @ $I_T=2.2A$	Capacitance @ 1MHz, 2V bias	
		V min	V max	mA min	mA max	A max	V max	pf min	pF max
P0080SDLRP	P-8D	6	25	50	800	2.2	4	50	150
P0640SDLRP	P06D	58	77	50	800	2.2	4	100	160
P0720SDLRP	P07D	65	88	50	800	2.2	4	100	150
P0900SDLRP	P09D	75	98	50	800	2.2	4	95	140
P1100SDLRP	P11D	90	130	50	800	2.2	4	75	115
P1300SDLRP	P13D	120	160	50	800	2.2	4	65	100
P1500SDLRP	P15D	140	180	50	800	2.2	4	60	90
P1800SDLRP	P18D	170	220	50	800	2.2	4	50	90
P2300SDLRP	P23D	190	260	50	800	2.2	4	50	80
P2600SDLRP	P26D	220	300	50	800	2.2	4	50	75
P3100SDLRP	P31D	275	350	50	800	2.2	4	45	70
P3500SDLRP	P35D	320	400	50	800	2.2	4	45	65

Notes:  
 - Absolute maximum ratings measured at  $T_A=25^\circ C$  (unless otherwise noted).  
 - Devices are uni-directional  
 \*\* Will meet 4.4A power cross requirement without fire hazard.

**Surge Ratings**

Series	$I_{PP}$									$I_{TSM}$ 50/60 Hz	di/dt
	0.2x310 <sup>1</sup>	2x10 <sup>1</sup>	8x20 <sup>1</sup>	10x160 <sup>1</sup>	10x560 <sup>1</sup>	5x320 <sup>1</sup>	10x360 <sup>1</sup>	10x1000 <sup>1</sup>	5x310 <sup>1</sup>		
	0.5x700 <sup>2</sup>	2x10 <sup>2</sup>	1.2x50 <sup>2</sup>	10x160 <sup>2</sup>	10x560 <sup>2</sup>	9x720 <sup>2</sup>	10x360 <sup>2</sup>	10x1000 <sup>2</sup>	10x700 <sup>2</sup>		
	A min	A min	A min	A min	A min	A min	A min	A min	A min	A min	A/μs max
D	—	1000	800	—	—	—	—	200	—	50	1000

Notes:  
 1 Current waveform in μs - Peak pulse current rating ( $I_{PP}$ ) is repetitive and guaranteed for the life of the product.  
 2 Voltage waveform in μs -  $I_{PP}$  ratings applicable over temperature range of -40°C to +85°C  
 - The device must initially be in thermal equilibrium with -40°C ≤  $T_J$  ≤ +150°C

**Thermal Considerations**

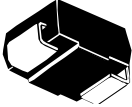
Package	Symbol	Parameter	Value	Unit
DO-214AA 	$T_J$	Operating Junction Temperature Range	-40 to +150	°C
	$T_S$	Storage Temperature Range	-65 to +150	°C
	$R_{θJA}$	Thermal Resistance: Junction to Ambient	90	°C/W

High Surge Current Series

**V-I Characteristics**

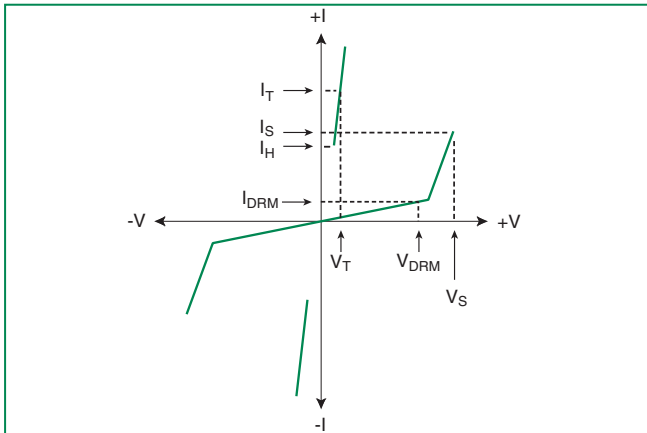

**$t_r$  x  $t_d$  Pulse Waveform**

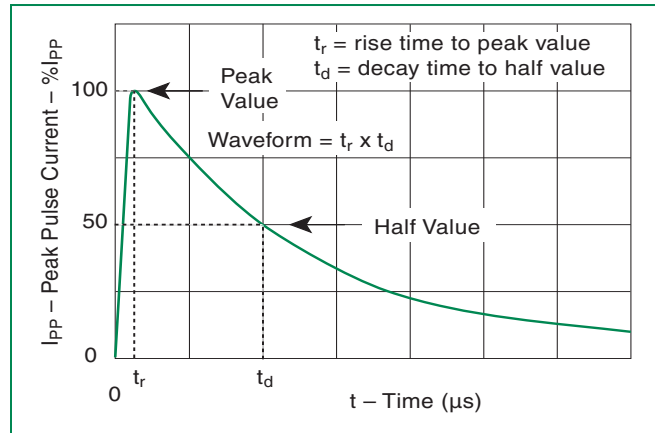

**Normalized  $V_S$  Change vs. Junction Temperature**

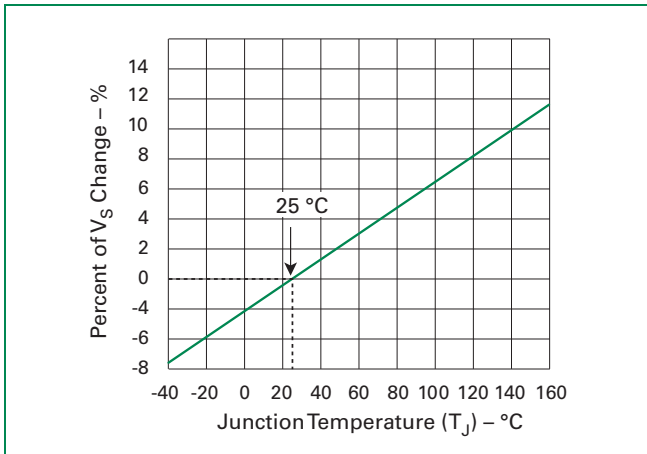

**Normalized DC Holding Current vs. Case Temperature**

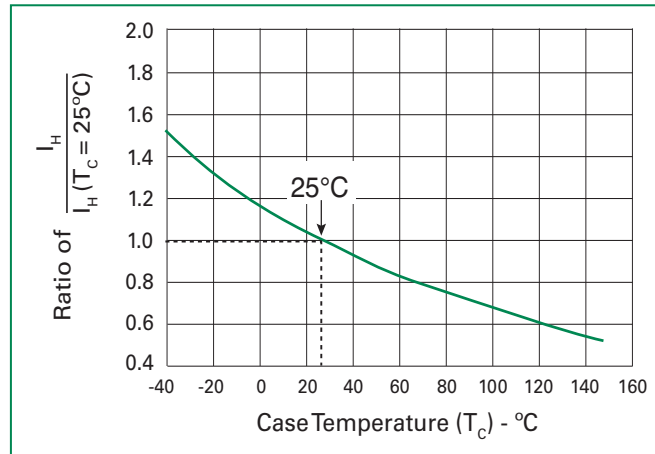

**Soldering Parameters**

Reflow Condition		Pb-Free assembly (see Fig. 1)
Pre Heat	- Temperature Min ( $T_{s(min)}$ )	+150°C
	- Temperature Max ( $T_{s(max)}$ )	+200°C
	- Time (Min to Max) ( $t_s$ )	60-180 secs.
Average ramp up rate (LiquidusTemp ( $T_L$ ) to peak)		3°C/sec. Max.
$T_{s(max)}$ to $T_L$ - Ramp-up Rate		3°C/sec. Max.
Reflow	- Temperature ( $T_L$ ) (Liquidus)	+217°C
	- Temperature ( $t_L$ )	60-150 secs.
Peak Temp ( $T_p$ )		+260(+0/-5)°C
Time within 5°C of actual Peak Temp ( $t_p$ )		30 secs. Max.
Ramp-down Rate		6°C/sec. Max.
Time 25°C to Peak Temp ( $T_p$ )		8 min. Max.
Do not exceed		+260°C

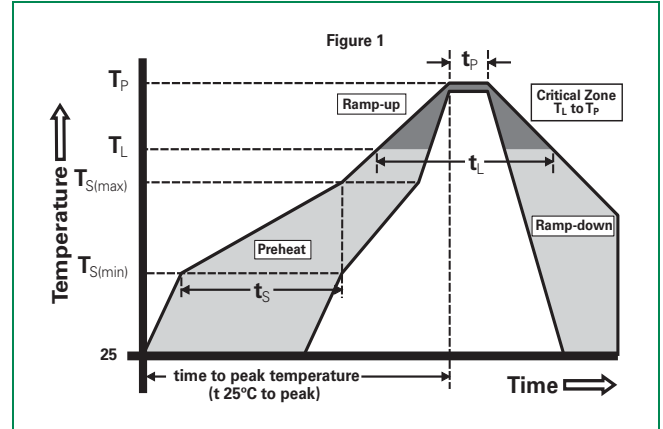

**Physical Specifications**

<b>Lead Material</b>	Copper Alloy
<b>Terminal Finish</b>	100% Matte-Tin Plated
<b>Body Material</b>	UL recognized epoxy meeting flammability classification 94V-0

**Environmental Specifications**

<b>High Temp Voltage Blocking</b>	80% Rated $V_{DRM}$ ( $V_{AC}$ Peak) +125°C or +150°C, 504 or 1008 hrs. MIL-STD-750 (Method 1040) JEDEC, JESD22-A-101
<b>Temp Cycling</b>	-65°C to +150°C, 15 min. dwell, 10 up to 100 cycles. MIL-STD-750 (Method 1051) EIA/JEDEC, JESD22-A104
<b>Biased Temp &amp; Humidity</b>	52 $V_{DC}$ (+85°C) 85%RH, 504 up to 1008 hrs. EIA/JEDEC, JESD22-A-101
<b>High Temp Storage</b>	+150°C 1008 hrs. MIL-STD-750 (Method 1031) JEDEC, JESD22-A-101
<b>Low Temp Storage</b>	-65°C, 1008 hrs.
<b>Thermal Shock</b>	0°C to +100°C, 5 min. dwell, 10 sec. transfer, 10 cycles. MIL-STD-750 (Method 1056) JEDEC, JESD22-A-106
<b>Autoclave (Pressure Cooker Test)</b>	+121°C, 100%RH, 2atm, 24 up to 168 hrs. EIA/JEDEC, JESD22-A-102
<b>Resistance to Solder Heat</b>	+260°C, 30 secs. MIL-STD-750 (Method 2031)
<b>Moisture Sensitivity Level</b>	85%RH, +85°C, 168 hrs., 3 reflow cycles (+260°C Peak). JEDEC-J-STD-020, Level 1

**Part Numbering**

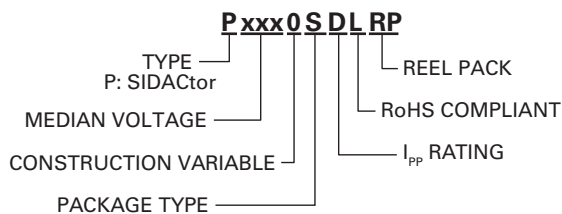

**Part Marking**

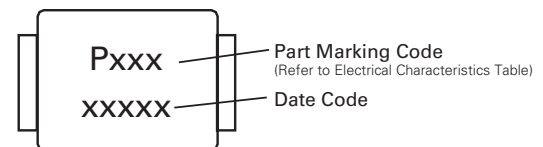

**Dimensions — DO-214AA**

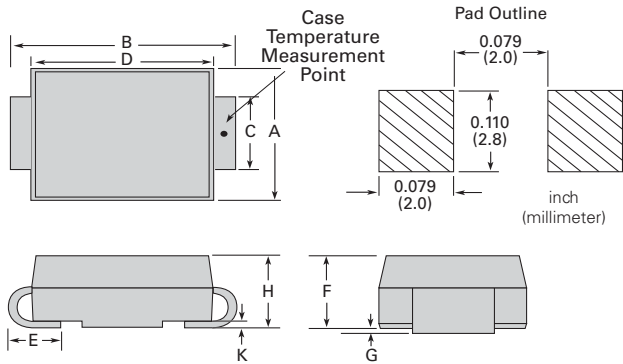

Dimensions	Inches		Millimeters	
	Min	Max	Min	Max
A	0.130	0.156	3.30	3.95
B	0.201	0.220	5.10	5.60
C	0.077	0.087	1.95	2.20
D	0.159	0.181	4.05	4.60
E	0.030	0.063	0.75	1.60
F	0.075	0.096	1.90	2.45
G	0.002	0.008	0.05	0.20
H	0.077	0.104	1.95	2.65
K	0.006	0.016	0.15	0.41

**Packing Options**

Package Type	Description	Quantity	Added Suffix	Industry Standard
S	DO-214AA Tape and Reel Pack	2500	RP	EIA-481-D

**Tape and Reel Specification — DO-214AA**

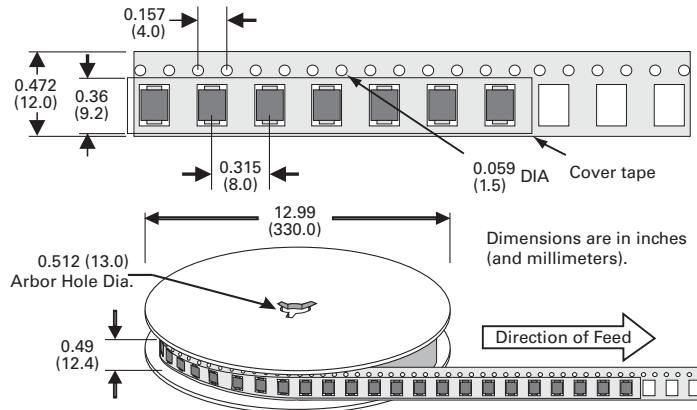

High Surge Current Series

## Looking for pricing, stock, or lifecycle information?

Click below to explore more details on WIN SOURCE:

 [View P1100SDLRP on WIN SOURCE](#)

 [Littelfuse Inc. Information](#)

## Optimize Your Supply Chain with WIN SOURCE Solutions

-  Global Sourcing Solution
-  Obsolete Management
-  Cost Control Management
-  Shortage Management
-  Alternative Solution
-  Excess Inventory Management