



**THE DATASHEET OF
P0300SCMCLRP**



MC Series - DO-214



Agency Approvals

Agency	Agency File Number
	E133083

Pinout Designation

NOT APPLICABLE

Schematic Symbol



Description

The MC Series DO-214 are low capacitance SIDACtor® components designed to protect broadband equipment such as VOIP, DSL modems and DSLAMs from damaging overvoltage transients.

The series provides a surface mount solution that enables equipment to comply with global regulatory standards while limiting the impact to broadband signals.

Features and Benefits

- Low voltage overshoot
- Low on-state voltage
- Does not degrade surge capability after multiple surge events within limit.
- 40% lower capacitance than our Baseband Protectors, for applications that demand greater signal integrity
- RoHS Compliant and Halogen-Free
- Pb-free E3 means 2nd level interconnect is Pb-free and the terminal finish material is tin(Sn) (IPC/JEDEC J-STD-609A.01)
- Fails short circuit when surged in excess of ratings

Applicable Global Standards

- TIA-968-A
- TIA-968-B
- ITU K.20/21/45 Enhanced Level*
- ITU K.20/21/45 Basic Level
- GR 1089 Inter-building*
- GR 1089 Intra-building
- IEC 61000-4-5 2nd edition
- YD/T 1082
- YD/T 993
- YD/T 950

*A-rated parts require series resistance

Electrical Characteristics

Part Number	Marking	V_{DRM} @ $I_{DRM}=5\mu A$	V_S @ 100V/ μs	I_H	I_S	I_T	V_T @ $I_T=2.2$ Amps	Capacitance @ 1MHz, 2V bias	
		V min	V max	mA min	mA max	A max	V max	pF min	pF max
P0080SAMCLRP	P-8AM	6	25	50	800	2.2	4	10	35
P0220SAMCLRP	P02AM	15	32	50	800	2.2	4	10	35
P0300SAMCLRP	P03AM	25	40	50	800	2.2	4	10	35
P0080SCMCLRP	P-8CM	6	25	50	800	2.2	4	25	60
P0220SCMCLRP	P02CM	15	32	50	800	2.2	4	25	60
P0300SCMCLRP	P03CM	25	40	50	800	2.2	4	15	40
P0640SCMCLRP	P06CM	58	77	150	800	2.2	4	50	80
P0720SCMCLRP	P07CM	65	88	150	800	2.2	4	50	75
P0900SCMCLRP	P09CM	75	98	150	800	2.2	4	40	70
P1100SCMCLRP	P11CM	90	130	150	800	2.2	4	40	70
P1300SCMCLRP	P13CM	120	160	150	800	2.2	4	35	60
P1500SCMCLRP	P15CM	140	180	150	800	2.2	4	30	55
P1800SCMCLRP	P18CM	170	220	150	800	2.2	4	30	50
P2100SCMCLRP	P21CM	180	240	150	800	2.2	4	30	50
P2300SCMCLRP	P23CM	190	260	150	800	2.2	4	30	50
P2600SCMCLRP	P26CM	220	300	150	800	2.2	4	30	45
P3100SCMCLRP	P31CM	275	350	150	800	2.2	4	30	45
P3500SCMCLRP	P35CM	320	400	150	800	2.2	4	25	50
P4500SCMCLRP	P45CM	400	530	50	800	2.2	4	25	45

Notes:

- Absolute maximum ratings measured at $T_A=25^\circ C$ (unless otherwise noted).
- Components are bi-directional.

Surge Ratings

Series	I_{PP}										I_{TSM} 50/60 Hz	di/dt
	0.2/310 ¹	2/10 ¹	8/20 ¹	10/160 ¹	10/560 ¹	5/320 ¹	10/360 ¹	10/1000 ¹	5/310 ¹	10/700 ¹		
	0.5/700 ²	2/10 ²	1.2/50 ²	10/160 ²	10/560 ²	9/720 ²	10/360 ²	10/1000 ²	10/700 ²			
	A min	A min	A min	A min	A min	A min	A min	A min	A min	A min	A/μs max	
A	20	150	150	90	50	75	75	45	75	25	500	
C	50	500	400	200	150	200	175	100	200 ³	35	500	

Notes:
 1 Current waveform in μs
 2 Voltage waveform in μs
 3 For surge rating of P4500SCMCLRP 10/700μs min=150A

- Peak pulse current rating (I_{PP}) is repetitive and guaranteed for the life of the product that remains in thermal equilibrium.
 - I_{PP} ratings applicable over temperature range of -40°C to +85°C
 - The component must initially be in thermal equilibrium with -40°C ≤ T_J ≤ +150°C

Thermal Considerations

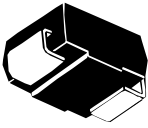
Package	Symbol	Parameter	Value	Unit
DO-214AA 	T_J	Operating Junction Temperature Range	-40 to +150	°C
	T_S	Storage Temperature Range	-65 to +150	°C
	$R_{θJA}$	Thermal Resistance: Junction to Ambient	90	°C/W

V-I Characteristics

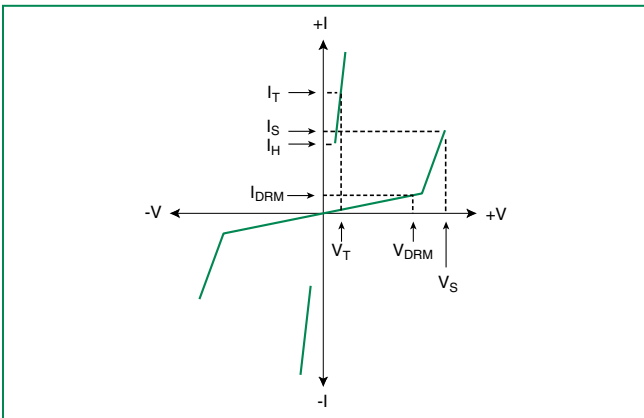

$t_r \times t_d$ Pulse Waveform

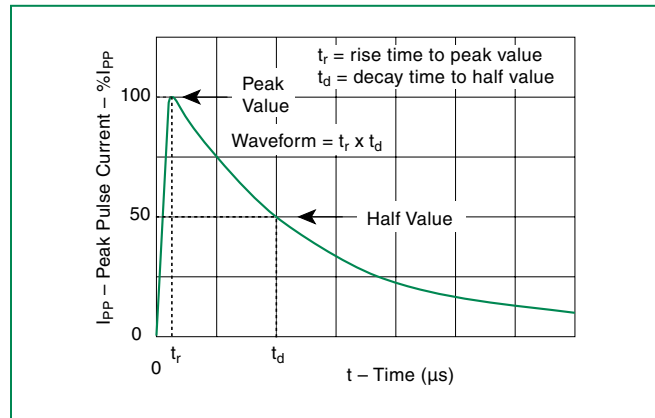

Normalized V_S Change vs. Junction Temperature

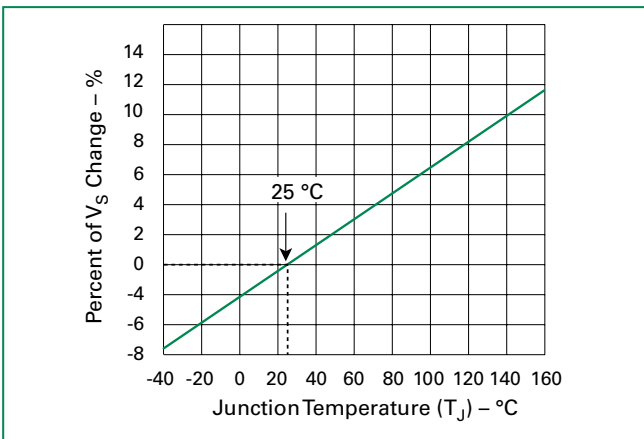

Normalized DC Holding Current vs. Case Temperature

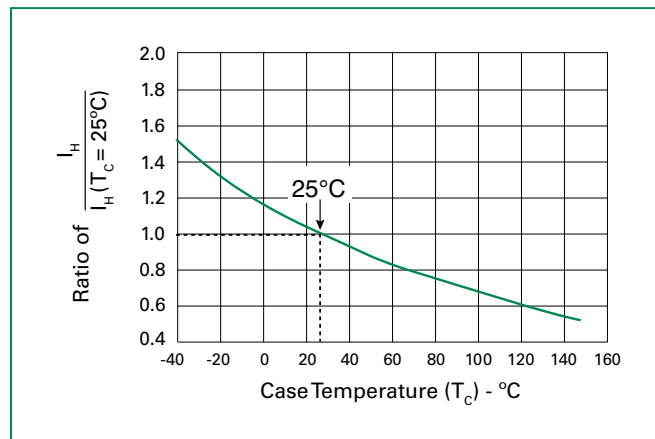

Soldering Parameters

Reflow Condition	Pb-Free assembly (see Fig. 1)	
Pre Heat	-Temperature Min ($T_{s(min)}$)	+150°C
	-Temperature Max ($T_{s(max)}$)	+200°C
	-Time (Min to Max) (t_s)	60-180 secs.
Average ramp up rate (Liquidus Temp (T_L) to peak)	3°C/sec. Max.	
$T_{s(max)}$ to T_L - Ramp-up Rate	3°C/sec. Max.	
Reflow	-Temperature (T_L) (Liquidus)	+217°C
	-Temperature (t_L)	60-150 secs.
Peak Temp (T_p)	+260(+0/-5)°C	
Time within 5°C of actual PeakTemp (t_p)	30 secs. Max.	
Ramp-down Rate	6°C/sec. Max.	
Time 25°C to Peak Temp (T_p)	8 min. Max.	
Do not exceed	+260°C	

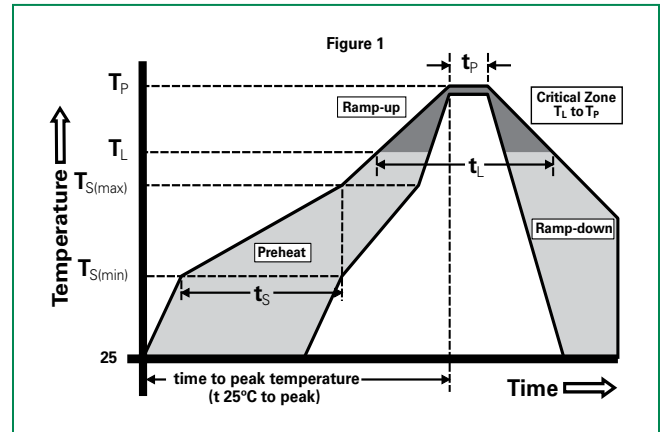

Physical Specifications

Lead Material	Copper Alloy
Terminal Finish	100% Matte-Tin Plated
Body Material	UL Recognized epoxy meeting flammability classification V-0

Environmental Specifications

High Temp Voltage Blocking	80% Rated V_{DRM} ($V_{AC \text{ Peak}}$) +125°C or +150°C, 504 or 1008 hrs. MIL-STD-750 (Method 1040) JEDEC, JESD22-A-101
Temp Cycling	-65°C to +150°C, 15 min. dwell, 10 up to 100 cycles. MIL-STD-750 (Method 1051) EIA/JEDEC, JESD22-A104
Biased Temp & Humidity	52 V_{DC} (+85°C) 85%RH, 504 up to 1008 hrs. EIA/JEDEC, JESD22-A-101
High Temp Storage	+150°C 1008 hrs. MIL-STD-750 (Method 1031) JEDEC, JESD22-A-101
Low Temp Storage	-65°C, 1008 hrs.
Thermal Shock	0°C to +100°C, 5 min. dwell, 10 sec. transfer, 10 cycles. MIL-STD-750 (Method 1056) JEDEC, JESD22-A-106
Autoclave (Pressure Cooker Test)	+121°C, 100%RH, 2atm, 24 up to 168 hrs. EIA/JEDEC, JESD22-A-102
Resistance to Solder Heat	+260°C, 30 secs. MIL-STD-750 (Method 2031)
Moisture Sensitivity Level	85%RH, +85°C, 168 hrs., 3 reflow cycles (+260°C Peak). JEDEC-J-STD-020, Level 1

Additional Information



Datasheet



Resources



Samples

Dimensions – DO-214AA

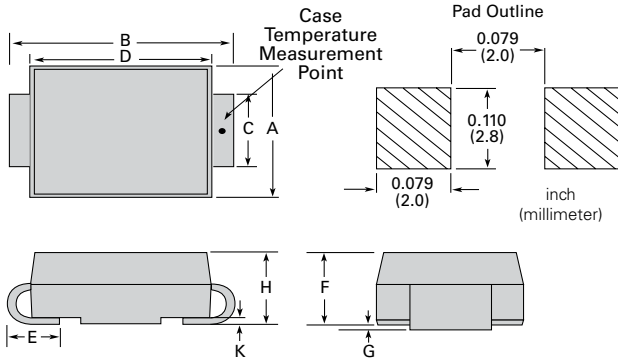

Dimensions	Inches		Millimeters	
	Min	Max	Min	Max
A	0.130	0.156	3.30	3.95
B	0.201	0.220	5.10	5.60
C	0.077	0.087	1.95	2.20
D	0.159	0.181	4.05	4.60
E	0.030	0.063	0.75	1.60
F	0.075	0.096	1.90	2.45
G	0.002	0.008	0.05	0.20
H	0.077	0.104	1.95	2.65
K	0.006	0.016	0.15	0.41

Part Numbering

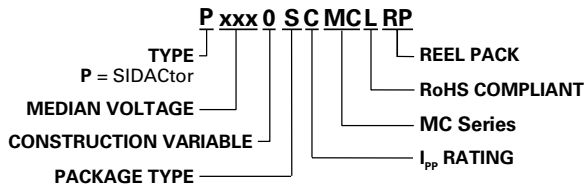

Part Marking

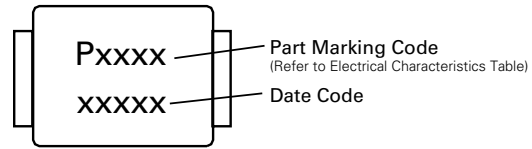

Packing Options

Package Type	Description	Quantity	Added Suffix	Industry Standard
S	DO-214AA Tape & Reel Pack	2500	N/A	EIA-481-D

Tape and Reel Specification – DO-214AA

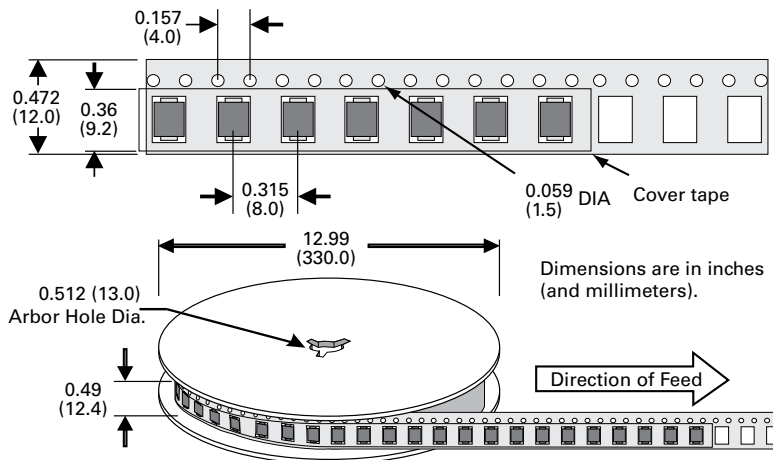

Disclaimer Notice - Information furnished is believed to be accurate and reliable. However, users should independently evaluate the suitability of and test each product selected for their own applications. Littelfuse products are not designed for, and may not be used in, all applications. Read complete Disclaimer Notice at www.littelfuse.com/disclaimer-electronics.

Looking for pricing, stock, or lifecycle information?

Click below to explore more details on WIN SOURCE:

 [View P0300SCMCLRP on WIN SOURCE](#)

 [Littelfuse Inc. Information](#)

Optimize Your Supply Chain with WIN SOURCE Solutions

-  Global Sourcing Solution
-  Obsolete Management
-  Cost Control Management
-  Shortage Management
-  Alternative Solution
-  Excess Inventory Management