



THE DATASHEET OF
3314G-1-101E





Features

- Surface Mount / Single Turn / Cermet Industrial / Sealed
- Compatible with surface mount manufacturing processes
- Compatible with popular vacuum pick-and-place equipment
- J-hook, gull-wing & pinned configurations

- Side adjust available
- Meets EIA/EIAJ/IPC/VECI SMD standard trimmer designs
- RoHS compliant* - see [processing information](#) on lead free surface mount trimmers
- For trimmer applications/processing guidelines, [click here](#)

3314 - 4 mm Square Trimpot® Trimming Potentiometer

Electrical Characteristics

Standard Resistance Range 10 ohms to 2 megohms (see standard resistance table)
 Resistance Tolerance ±20 % std. (tighter tolerance available)
 End Resistance 1 % or 2 ohms max. (whichever is greater)
 Contact Resistance Variation 3 % or 3 ohms
 Resolution Infinite
 Insulation Resistance 500 vdc. 100 megohms min.
 Dielectric Strength
 Sea Level..... 500 vac (1 minute)
 Adjustment Angle 210 ° nom.

Environmental Characteristics

Power Rating (300 volts max. for Style G, J & H; 50 volts max. for Style R)
 70 °C 0.25 watt
 125 °C 0 watt
 Temperature Range ... -55 °C to +125 °C
 Temperature Coefficient ... ±100 ppm/°C
 Seal Test .. 85 °C Fluorinert / 60 seconds
 Humidity 90-98 % RH, 10 cycles, 240 hours
 Vibration 20 G TRS ±1 %; VRS ±1 %
 Shock 100 G TRS ±1 %; VRS ±1 %
 Load Life
 (@ 70 °C Rated Power 1000 Hours)
 Rotational Life TRS ±3 %
 100 cycles
 Thermal Shock TRS ±3 %
 5 cycles
 TRS ±2 %; VRS ±1 %

Physical Characteristics

Mechanical Angle 240 ° nom.
 Torque..... 180 g-cm max.
 Stop Strength 300 g-cm min.
 Pushover Strength (S & Z Style)
 1.6 kilograms (3.5 lbs.) min.
 Weight Approximately 0.01 oz.
 Marking..... Manufacturer's code, resistance code and date code
 Wiper 50 % (Actual TR) ±10 %
 Flammability U.L. 94V-0
 Standard Packaging
 J, G and R... 500 pcs./7 " reel (MSL-1)
 S and Z..... 200 pcs./7 " reel (MSL-1)
 H..... 100 pcs./tube
 Adjustment Tool..... H-90

Product Dimensions

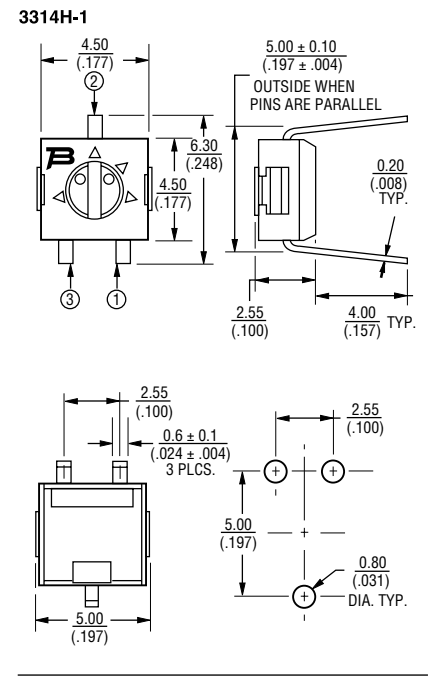

3314J-1, G-1, R-1, H-1 (Bourns Marking, Straight Slot) and 3314J-2, G-2, R-2, H-2 (Bourns Marking, Cross Slot)

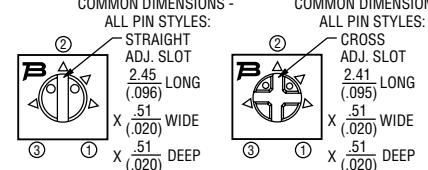

3314J-3, G-3, R-3, H-3 (Reverse Marking, Straight Slot) and 3314J-4, G-4, R-4, H-4 (Reverse Marking, Cross Slot)

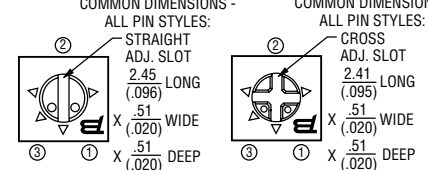

DIMENSIONS: $\frac{\text{MM}}{\text{(INCHES)}}$
 TOLERANCES: ± $\frac{0.30}{(.012)}$ EXCEPT WHERE NOTED



WARNING Cancer and Reproductive Harm - www.P65Warnings.ca.gov

*RoHS Directive 2002/95/EC Jan. 27, 2003 including annex and RoHS Recast 2011/65/EU June 8, 2011.
 †"Fluorinert" is a registered trademark of 3M Co.
 Specifications are subject to change without notice.
 Users should verify actual device performance in their specific applications.
 The products described herein and this document are subject to specific legal disclaimers as set forth on the last page of this document, and at www.bourns.com/docs/legal/disclaimer.pdf.

3314 - 4 mm Square Trimpot® Trimming Potentiometer

BOURNS®

Product Dimensions

3314R-1



3314R-GM5



3314S-1 (Bourns Marking, Straight Slot)



3314S-2 (Bourns Marking, Cross Slot)



3314S-3 (Reverse Marking, Straight Slot)



3314S-4 (Reverse Marking, Cross Slot)



3314S Common Dimensions



RECOMMENDED PCB LAYOUT

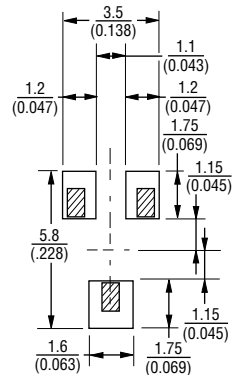

DIMENSIONS: $\frac{\text{MM}}{\text{(INCHES)}}$
 TOLERANCES: ± $\frac{0.30}{(.012)}$ EXCEPT WHERE NOTED

3314 - 4 mm Square Trimpot® Trimming Potentiometer

BOURNS®

Product Dimensions

3314Z-1-(RC) E
(Cross Slot)



ROTOR POSITIONED AS SHOWN WITHIN $\pm 22^\circ$ OF CENTERLINE OF TERMINAL 2

3314Z-GA4-(RC) E
(Straight Slot)



ROTOR POSITIONED AS SHOWN WITHIN $\pm 22^\circ$ OF CENTERLINE OF TERMINAL 2

3314Z-3
(Reverse Marking, Straight Slot)



ROTOR POSITIONED AS SHOWN WITHIN $\pm 22^\circ$ OF CENTERLINE OF TERMINAL 2

3314Z-4-(RC) E
(Reverse Marking, Cross Slot)

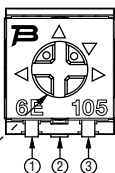

ROTOR POSITIONED AS SHOWN WITHIN $\pm 22^\circ$ OF CENTERLINE OF TERMINAL 2

3314Z
Common Dimensions



RECOMMENDED PCB LAYOUT



Packaging Specifications

(J, G Styles)

TAPE



REEL



* Embossed Tape Designator "E"

** Embossed Tape Designator "G"

(See How To Order chart for further information.)

Meets EIA specification 481.

DIMENSIONS:	MM (INCHES)
TOLERANCES:	± 0.30 (.012) EXCEPT WHERE NOTED

Specifications are subject to change without notice.

Users should verify actual device performance in their specific applications.

The products described herein and this document are subject to specific legal disclaimers as set forth on the last page of this document, and at www.bourns.com/docs/legal/disclaimer.pdf.

3314 - 4 mm Square Trimpot® Trimming Potentiometer

BOURNS®

Packaging Specifications

(R Style)

TAPE

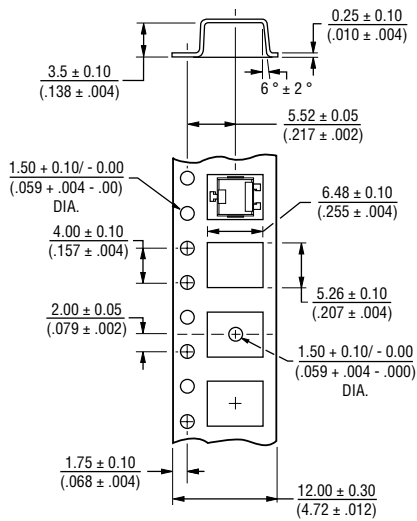

REEL

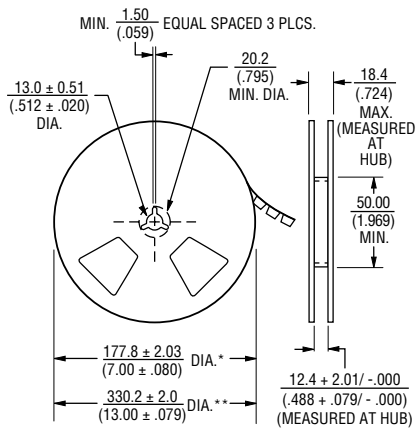

* Embossed Tape Designator "E"
 ** Embossed Tape Designator "G"
 (See How To Order chart for further information.)

Meets EIA specification 481.

DIMENSIONS: $\frac{\text{MM}}{\text{(INCHES)}}$

TOLERANCES: $\pm \frac{0.30}{(.012)}$ EXCEPT WHERE NOTED

(R-GM5 Style)

TAPE

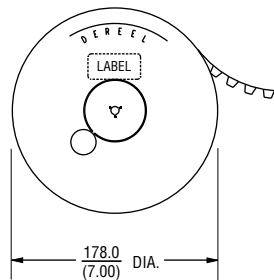
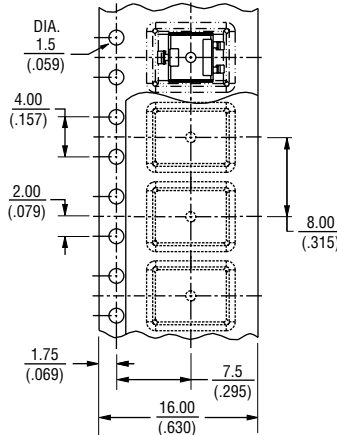
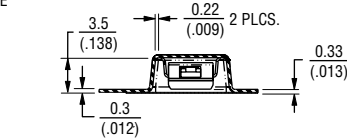

(S Style)

TAPE

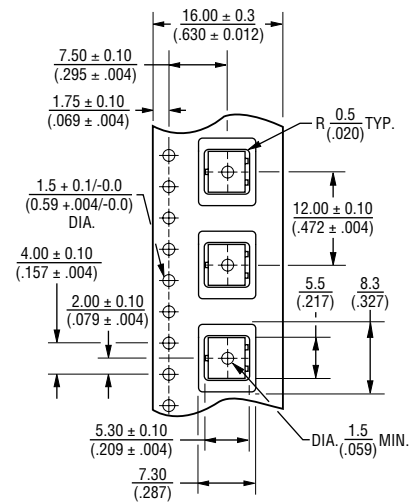
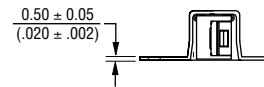

REEL

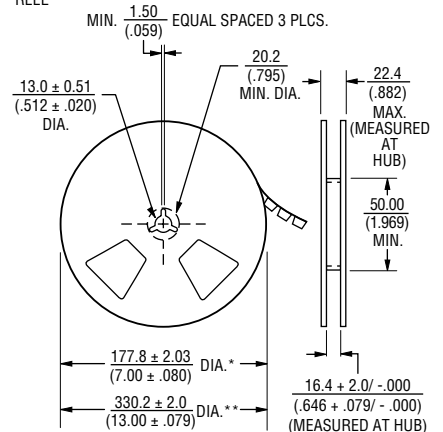

* Embossed Tape Designator "E"
 ** Embossed Tape Designator "G"
 (See How To Order chart for further information.)

Meets EIA specification 481.

3314 - 4 mm Square Trimpot® Trimming Potentiometer

BOURNS®

Packaging Specifications

(Z Style)



How To Order

3314 J - 1 - 502 E

Model _____
 Style _____
 Standard or Modified Product Indicator (Styles J, G, H & S) _____
 -1 = Single Slot
 -2 = Cross Slot
 -3 = Single Slot w/Reverse Marking
 -4 = Cross Slot w/Reverse Marking
 Product Indicator (Style R only)
 -GM5 = Cross Slot w/Extended Lead Frame
 -1 = Single Slot
 -2 = Cross Slot
 -3 = Single Slot w/Reverse Marking
 -4 = Cross Slot w/Reverse Marking
 Product Indicator (Style Z only)
 -GA4 = Single Slot
 -1 = Cross Slot
 -3 = Single Slot w/Reverse Marking
 -4 = Cross Slot w/Reverse Marking
 Resistance Code _____
 Embossed Tape Designator (MSL-1)** _____
 E = Styles J, G and R: 500 pcs./7" reel
 Styles S and Z: 200 pcs./7" reel
 G = Styles J and G: 3000 pcs./13" reel
 Style R: 2500 pcs./13" reel
 Styles S and Z: 1000 pcs./13" reel
 **Style H is available in tube packaging only.

Standard Resistance Table

Resistance (Ohms)	Resistance Code
10	100
20	200
50	500
100	101
200	201
500	501
1,000	102
2,000	202
5,000	502
10,000	103
20,000	203
50,000	503
100,000	104
200,000	204
250,000	254
500,000	504
1,000,000	105
2,000,000	205

Popular distribution values listed in boldface.
 Special resistances available.

Tape and reel material meets Antistatic ANSI/ESD 5541-2003 packaging standards.

* Embossed Tape Designator "E"
 ** Embossed Tape Designator "G"
 (See How To Order chart for further information.)

Meets EIA specification 481.

DIMENSIONS: $\frac{\text{MM}}{\text{(INCHES)}}$
 TOLERANCES: $\pm \frac{0.30}{(.012)}$ EXCEPT WHERE NOTED

REV. 05/19

Specifications are subject to change without notice.

Users should verify actual device performance in their specific applications.

The products described herein and this document are subject to specific legal disclaimers as set forth on the last page of this document, and at www.bourns.com/docs/legal/disclaimer.pdf.

This legal disclaimer applies to purchasers and users of Bourns® products manufactured by or on behalf of Bourns, Inc. and its affiliates (collectively, "Bourns").

Unless otherwise expressly indicated in writing, Bourns® products and data sheets relating thereto are subject to change without notice. Users should check for and obtain the latest relevant information and verify that such information is current and complete before placing orders for Bourns® products.

The characteristics and parameters of a Bourns® product set forth in its data sheet are based on laboratory conditions, and statements regarding the suitability of products for certain types of applications are based on Bourns' knowledge of typical requirements in generic applications. The characteristics and parameters of a Bourns® product in a user application may vary from the data sheet characteristics and parameters due to (i) the combination of the Bourns® product with other components in the user's application, or (ii) the environment of the user application itself. The characteristics and parameters of a Bourns® product also can and do vary in different applications and actual performance may vary over time. Users should always verify the actual performance of the Bourns® product in their specific devices and applications, and make their own independent judgments regarding the amount of additional test margin to design into their device or application to compensate for differences between laboratory and real world conditions.

Unless Bourns has explicitly designated an individual Bourns® product as meeting the requirements of a particular industry standard (e.g., ISO/TS 16949) or a particular qualification (e.g., UL listed or recognized), Bourns is not responsible for any failure of an individual Bourns® product to meet the requirements of such industry standard or particular qualification. Users of Bourns® products are responsible for ensuring compliance with safety-related requirements and standards applicable to their devices or applications.

Bourns® products are not recommended, authorized or intended for use in nuclear, lifesaving, life-critical or life-sustaining applications, nor in any other applications where failure or malfunction may result in personal injury, death, or severe property or environmental damage. Unless expressly and specifically approved in writing by two authorized Bourns representatives on a case-by-case basis, use of any Bourns® products in such unauthorized applications might not be safe and thus is at the user's sole risk. Life-critical applications include devices identified by the U.S. Food and Drug Administration as Class III devices and generally equivalent classifications outside of the United States.

Bourns expressly identifies those Bourns® standard products that are suitable for use in automotive applications on such products' data sheets in the section entitled "Applications." Unless expressly and specifically approved in writing by two authorized Bourns representatives on a case-by-case basis, use of any other Bourns® standard products in an automotive application might not be safe and thus is not recommended, authorized or intended and is at the user's sole risk. If Bourns expressly identifies a sub-category of automotive application in the data sheet for its standard products (such as infotainment or lighting), such identification means that Bourns has reviewed its standard product and has determined that if such Bourns® standard product is considered for potential use in automotive applications, it should only be used in such sub-category of automotive applications. Any reference to Bourns® standard product in the data sheet as compliant with the AEC-Q standard or "automotive grade" does not by itself mean that Bourns has approved such product for use in an automotive application.

Bourns® standard products are not tested to comply with United States Federal Aviation Administration standards generally or any other generally equivalent governmental organization standard applicable to products designed or manufactured for use in aircraft or space applications. Bourns expressly identifies Bourns® standard products that are suitable for use in aircraft or space applications on such products' data sheets in the section entitled "Applications." Unless expressly and specifically approved in writing by two authorized Bourns representatives on a case-by-case basis, use of any other Bourns® standard product in an aircraft or space application might not be safe and thus is not recommended, authorized or intended and is at the user's sole risk.

The use and level of testing applicable to Bourns® custom products shall be negotiated on a case-by-case basis by Bourns and the user for which such Bourns® custom products are specially designed. Absent a written agreement between Bourns and the user regarding the use and level of such testing, the above provisions applicable to Bourns® standard products shall also apply to such Bourns® custom products.

Users shall not sell, transfer, export or re-export any Bourns® products or technology for use in activities which involve the design, development, production, use or stockpiling of nuclear, chemical or biological weapons or missiles, nor shall they use Bourns® products or technology in any facility which engages in activities relating to such devices. The foregoing restrictions apply to all uses and applications that violate national or international prohibitions, including embargos or international regulations. Further, Bourns® products and Bourns technology and technical data may not under any circumstance be exported or re-exported to countries subject to international sanctions or embargoes. Bourns® products may not, without prior authorization from Bourns and/or the U.S. Government, be resold, transferred, or re-exported to any party not eligible to receive U.S. commodities, software, and technical data.

To the maximum extent permitted by applicable law, Bourns disclaims (i) any and all liability for special, punitive, consequential, incidental or indirect damages or lost revenues or lost profits, and (ii) any and all implied warranties, including implied warranties of fitness for particular purpose, non-infringement and merchantability.

For your convenience, copies of this Legal Disclaimer Notice with German, Spanish, Japanese, Traditional Chinese and Simplified Chinese bilingual versions are available at:

Web Page: <http://www.bourns.com/legal/disclaimers-terms-and-policies>

PDF: <http://www.bourns.com/docs/Legal/disclaimer.pdf>

Looking for pricing, stock, or lifecycle information?

Click below to explore more details on WIN SOURCE:

- [View 3314G-1-101E on WIN SOURCE](#)
- [Bourns Inc. Information](#)

Optimize Your Supply Chain with WIN SOURCE Solutions

- ✓ Global Sourcing Solution
- ✓ Obsolete Management
- ✓ Cost Control Management
- ✓ Shortage Management
- ✓ Alternative Solution
- ✓ Excess Inventory Management