



THE DATASHEET OF OPA602AP





High-Speed Precision *Difet*[®] OPERATIONAL AMPLIFIER

FEATURES

- WIDE BANDWIDTH: 6.5MHz
- HIGH SLEW RATE: 35V/μs
- LOW OFFSET: ±250μV max
- LOW BIAS CURRENT: ±1pA max
- FAST SETTLING TIME: 1μs to 0.01%
- UNITY-GAIN STABLE

DESCRIPTION

The OPA602 is a precision, wide bandwidth FET operational amplifier. Monolithic *Difet* (dielectrically isolated FET) construction provides an unusual combination of high-speed and accuracy.

Its wide-bandwidth design minimizes dynamic errors. High slew rate and fast settling time allow accurate signal processing in pulse and data conversion applications. Wide bandwidth and low distortion minimize AC errors. All specifications are rated with a 1kΩ resistor in parallel with 500pF load. The OPA602 is unity-gain stable and easily drives capacitive loads up to 1500pF.

Laser-trimmed input circuitry provides offset voltage and drift performance normally associated with precision bipolar op amps. *Difet* construction achieves extremely low input bias currents (1pA max) without compromising input voltage noise.

The OPA602's unique input cascode circuitry maintains low input bias current and precise input characteristics over its full input common-mode voltage range.

Difet[®] Burr-Brown Corp.

APPLICATIONS

- PRECISION INSTRUMENTATION
- OPTOELECTRONICS
- SONAR, ULTRASOUND
- PROFESSIONAL AUDIO EQUIPMENT
- MEDICAL EQUIPMENT
- DATA CONVERSION

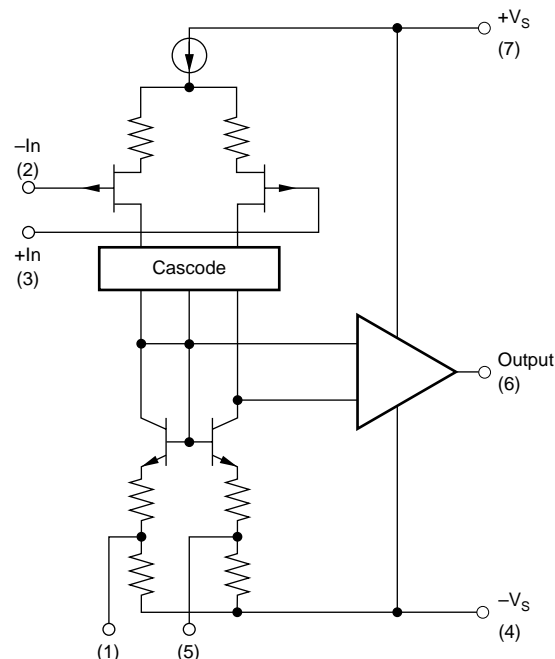

Please be aware that an important notice concerning availability, standard warranty, and use in critical applications of Texas Instruments semiconductor products and disclaimers thereto appears at the end of this data sheet.

ABSOLUTE MAXIMUM RATINGS⁽¹⁾

Supply Voltage	$\pm 18V_{DC}$
Internal Power Dissipation ($T_J \leq +175^\circ C$)	1000mW
Differential Input Voltage	Total V_S
Input Voltage Range	$\pm V_S$
Storage Temperature Range	
P and U Packages	$-40^\circ C$ to $+125^\circ C$
Operating Temperature Range	
P and U Packages	$-25^\circ C$ to $+85^\circ C$
Lead Temperature	
U Package, SO (3s)	$+260^\circ C$
Output Short-Circuit to Ground ($+25^\circ C$)	Continuous
Junction Temperature	$+175^\circ C$

NOTE: (1) Stresses above those listed under "Absolute Maximum Ratings" may cause permanent damage to the device. Exposure to absolute maximum conditions for extended periods may affect device reliability.



ELECTROSTATIC DISCHARGE SENSITIVITY

This integrated circuit can be damaged by ESD. Texas Instruments recommends that all integrated circuits be handled with appropriate precautions. Failure to observe proper handling and installation procedures can cause damage.

ESD damage can range from subtle performance degradation to complete device failure. Precision integrated circuits may be more susceptible to damage because very small parametric changes could cause the device not to meet its published specifications.

PACKAGE/ORDERING INFORMATION

PRODUCT	OFFSET VOLTAGE MAX (μV) AT $25^\circ C$	PACKAGE-LEAD	PACKAGE DESIGNATOR ⁽¹⁾	SPECIFIED TEMPERATURE RANGE	PACKAGE MARKING	ORDERING NUMBER	TRANSPORT MEDIA, QUANTITY
OPA602AP	± 2000	DIP-8	P	$-25^\circ C$ to $+85^\circ C$	602AP	602AP	Tubes, 50
OPA602BP	± 1000	"	"	"	602BP	602BP	Tubes, 50
OPA602AU	± 3000	SO-8	D	$-25^\circ C$ to $+85^\circ C$	602AU	602AU	Tubes, 100

NOTE: (1) For the most current specifications and package information, refer to our web site at www.ti.com.

PIN CONFIGURATIONS

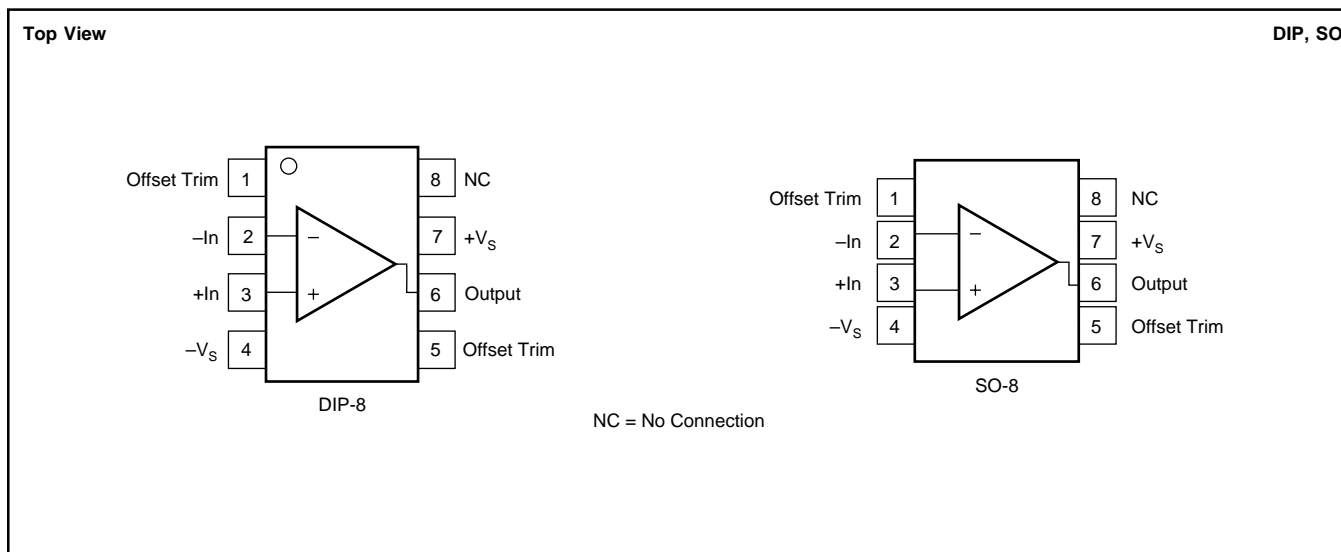

ELECTRICAL CHARACTERISTICS

At $V_S = \pm 15V_{DC}$ and $T_A = +25^\circ C$, unless otherwise noted.

PARAMETER	CONDITIONS	OPA602BP			OPA602AP, AU			UNITS	
		MIN	TYP	MAX	MIN	TYP	MAX		
INPUT NOISE Voltage: $f_O = 10\text{Hz}$ $f_O = 100\text{Hz}$ $f_O = 1\text{kHz}$ $f_O = 10\text{kHz}$ $f_B = 10\text{Hz to } 10\text{kHz}$ $f_B = 0.1\text{Hz to } 10\text{Hz}$ Current: $f_B = 0.1\text{Hz to } 10\text{Hz}$ $f_O = 0.1\text{Hz to } 20\text{kHz}$			23			*		$\text{nV}/\sqrt{\text{Hz}}$	
				19			*		$\text{nV}/\sqrt{\text{Hz}}$
				13			*		$\text{nV}/\sqrt{\text{Hz}}$
				12			*		$\text{nV}/\sqrt{\text{Hz}}$
				1.4			*		μVrms
				0.95			*		$\mu\text{Vp-p}$
				12			*		fAp-p
			0.6			*		fA/ $\sqrt{\text{Hz}}$	
OFFSET VOLTAGE Input Offset Voltage: P Package U Package Over Specified Temperature P, U Packages Average Drift ⁽¹⁾ Supply Rejection			0.5	1		1 1	2 3	mV mV	
			± 0.75	± 1.5		± 1.5		mV	
		$T_A = T_{\text{MIN}} \text{ to } T_{\text{MAX}}$	± 3	± 5		*	± 15	$\mu\text{V}/^\circ\text{C}$	
		$\pm V_S = 12\text{V to } 18\text{V}$	80	100	70	*		dB	
BIAS CURRENT Input Bias Current Over Specified Temperature	$V_{\text{CM}} = 0V_{\text{DC}}$		± 1 ± 20	± 2 ± 200		± 2 ± 20	± 10 ± 500	pA pA	
			0.5 20	2 200		1 20	10 500	pA pA	
OFFSET CURRENT Input Offset Current Over Specified Temperature	$V_{\text{CM}} = 0V_{\text{DC}}$		0.5 20	2 200		1 20	10 500	pA pA	
						*			
INPUT IMPEDANCE Differential Common-Mode			$10^{13} \parallel 1$ $10^{14} \parallel 3$			*		$\Omega \parallel \text{pF}$ $\Omega \parallel \text{pF}$	
						*			
INPUT VOLTAGE RANGE Common-Mode Input Range Common-Mode Rejection		± 10.2 88	+13, -11 100		*	*		V dB	
	$V_{\text{IN}} = \pm 10V_{\text{DC}}$				75	*			
OPEN-LOOP GAIN, DC Open-Loop Voltage Gain	$R_L \geq 1\text{k}\Omega$	88	100		75	*		dB	
FREQUENCY RESPONSE Gain Bandwidth Full-Power Response Slew Rate Settling Time: 0.1% 0.01%	Gain = 100 20Vp-p, $R_L = 1\text{k}\Omega$ $V_O = \pm 10\text{V}$, $R_L = 1\text{k}\Omega$	4	6.5 570		3.5	*		MHz kHz	
		24	35		20	*		V/ μs	
	Gain = -1, $R_L = 1\text{k}\Omega$ $C_L = 500\text{pF}$, 10V Step		0.6 1.0			*		μs μs	
RATED OUTPUT Voltage Output Current Output Output Resistance Load Capacitance Stability Short-Circuit Current	$R_L = 1\text{k}\Omega$	± 11.5	+12.9, -13.8		± 11	*		V	
	$V_O = \pm 10V_{\text{DC}}$ 1MHz, Open Loop Gain = +1	± 15	± 20 80 1500		*	*		mA Ω pF	
		± 30	± 50		± 25	*		mA	
POWER SUPPLY Rated Voltage Voltage Range, Derated Performance Current, Quiescent Over Specified Temperature		± 5	± 15	± 18 4 4.5	*	*	*	V_{DC} V_{DC} mA mA	
	$I_O = 0\text{mADC}$		3 3.5			*	*		
TEMPERATURE RANGE Specification Operating: P, U Packages Storage: P, U Packages θ_{JA}	Ambient Temperature	-25		+85	*		*	$^\circ\text{C}$	
		-25		+85	*		*	$^\circ\text{C}$	
		-40		+125	*		*	$^\circ\text{C}$	
		200			*		*	$^\circ\text{C/W}$	

* Same specifications as OPA602BP.

NOTE: (1) OPA602AP, AU ensured by design with a 99% confidence level.

TYPICAL CHARACTERISTICS

At $T_A = +25^\circ\text{C}$ and $V_S = \pm 15\text{V}_{\text{DC}}$, unless otherwise noted.

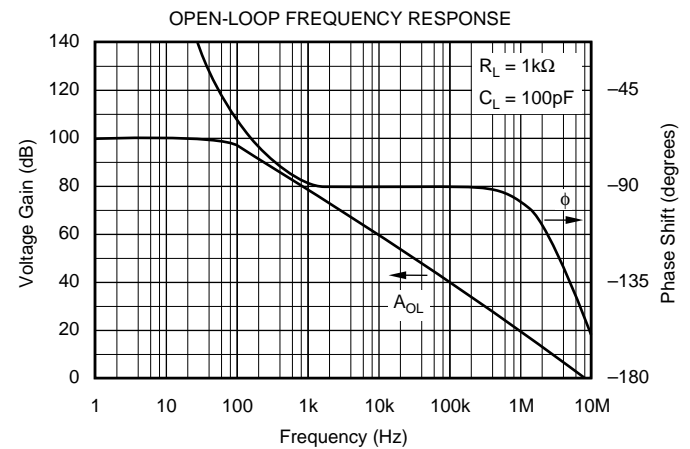
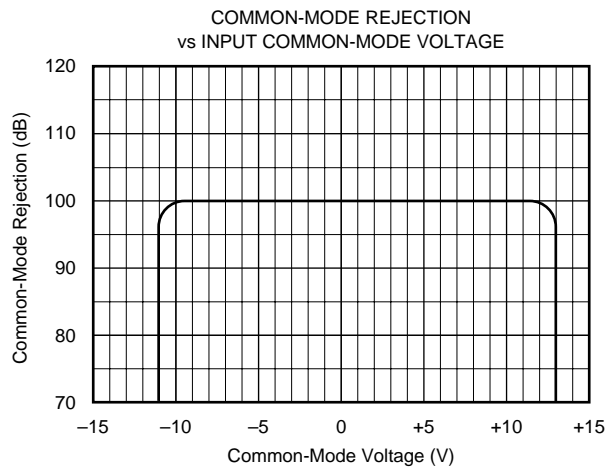
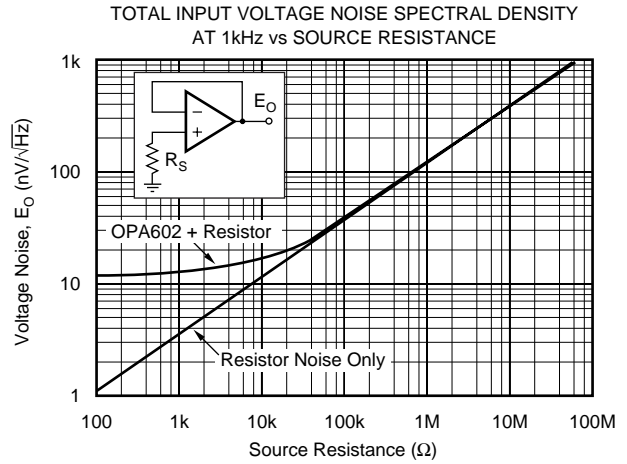
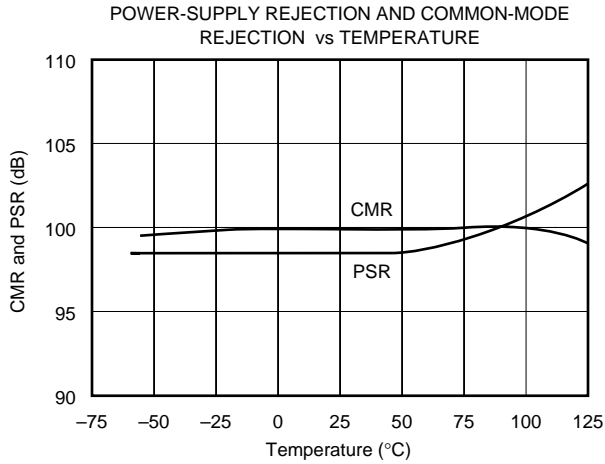
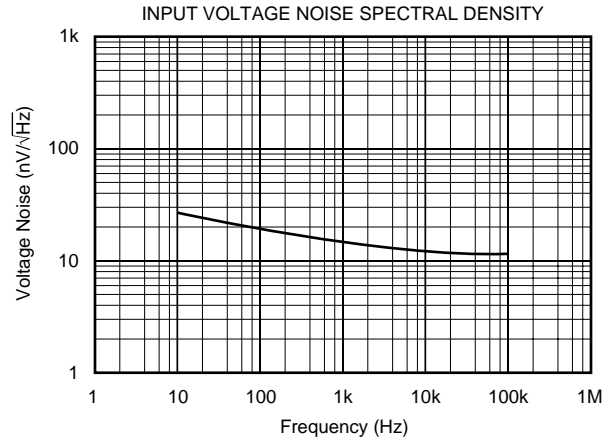
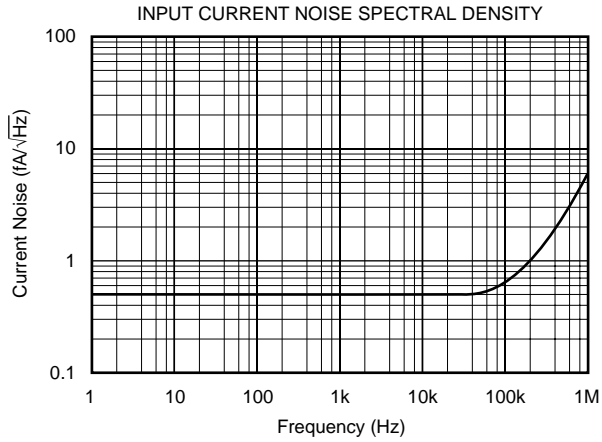

TYPICAL CHARACTERISTICS (Cont.)

At $T_A = +25^\circ\text{C}$ and $V_S = \pm 15\text{V}_{\text{DC}}$, unless otherwise noted.

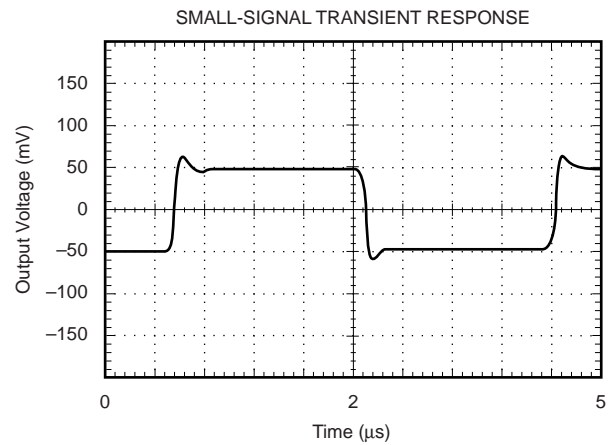
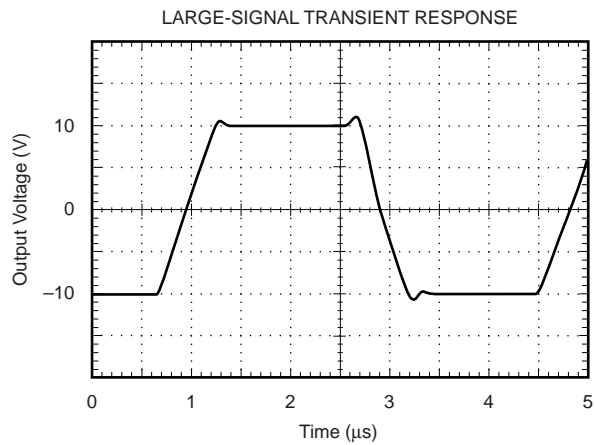
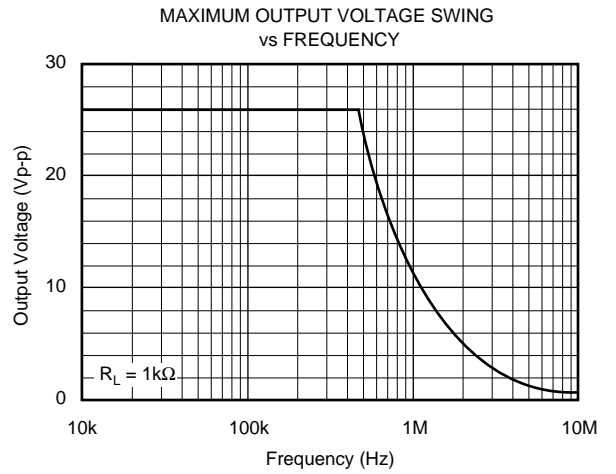
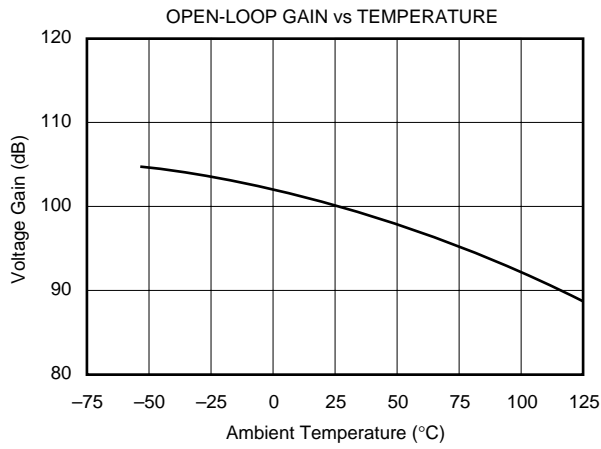
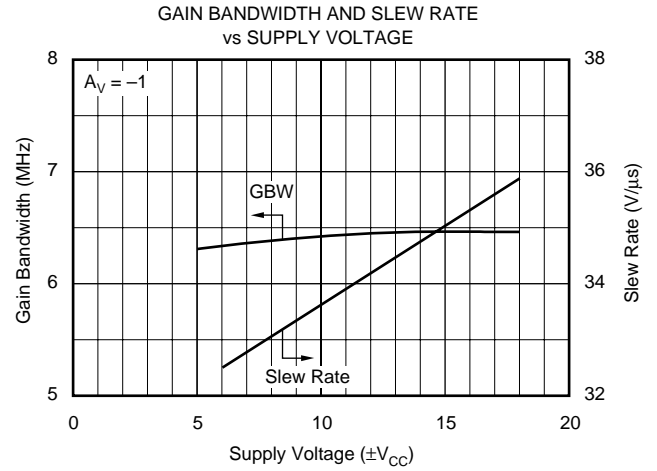
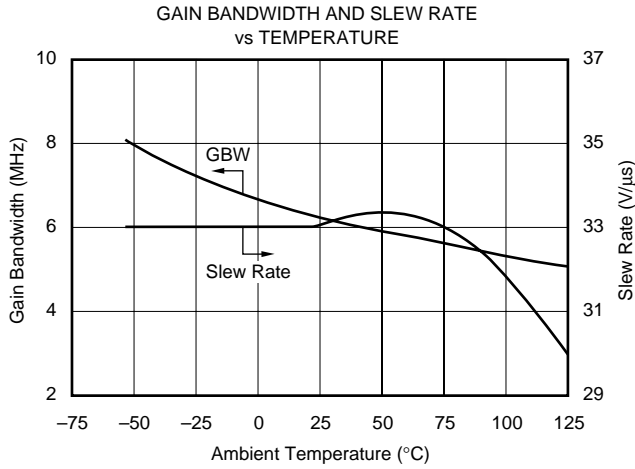

TYPICAL CHARACTERISTICS (Cont.)

At $T_A = +25^\circ\text{C}$ and $V_S = \pm 15\text{V}_{\text{DC}}$, unless otherwise noted.

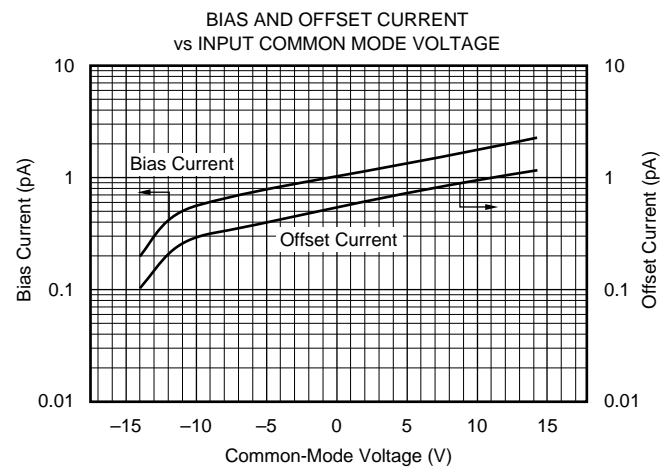
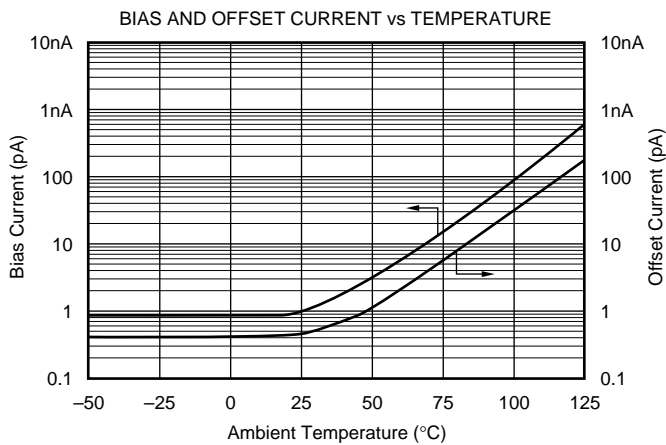
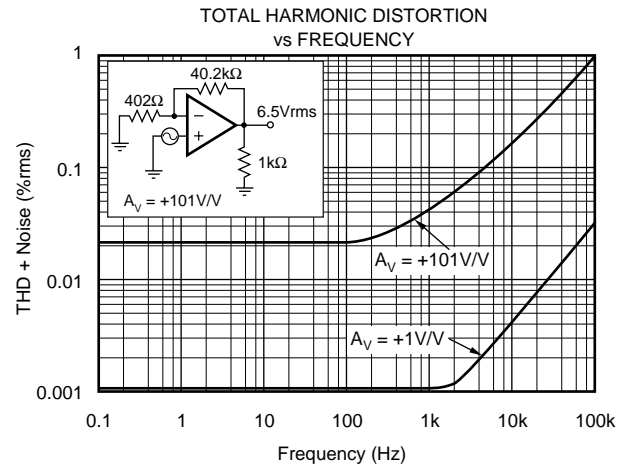
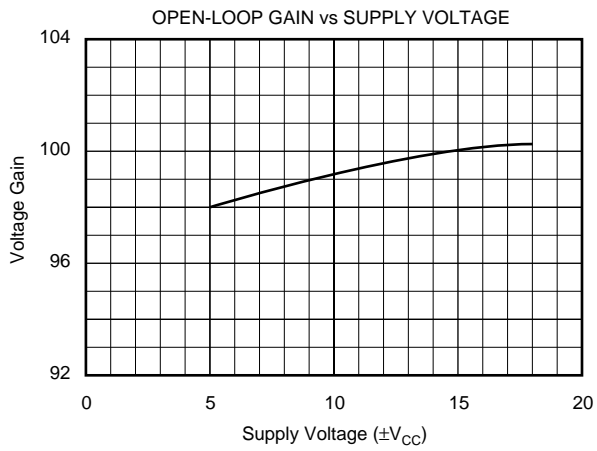
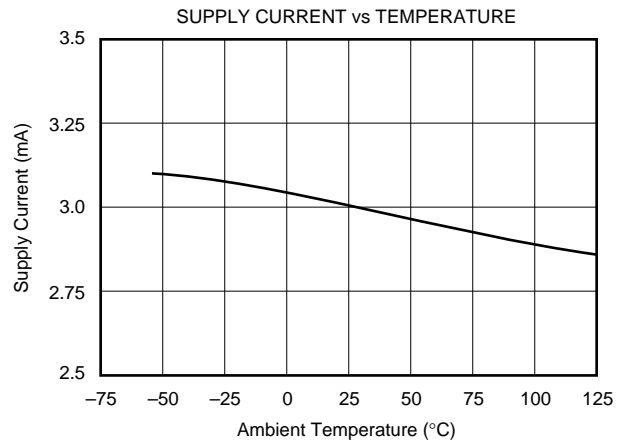
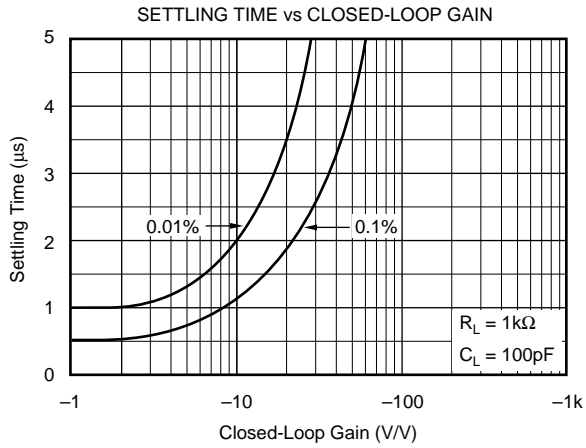

TYPICAL CHARACTERISTICS (Cont.)

At $T_A = +25^\circ\text{C}$ and $V_S = \pm 15\text{V}_{\text{DC}}$, unless otherwise noted.

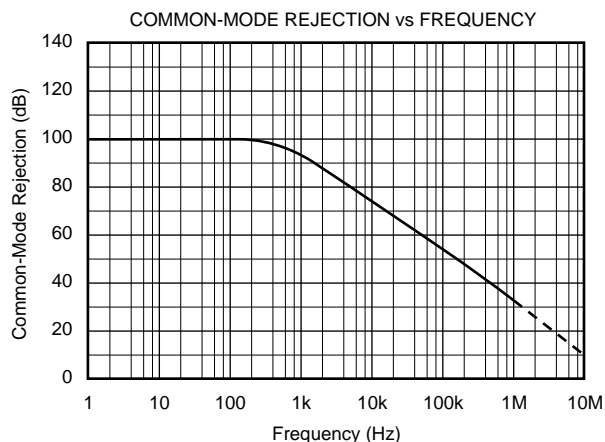
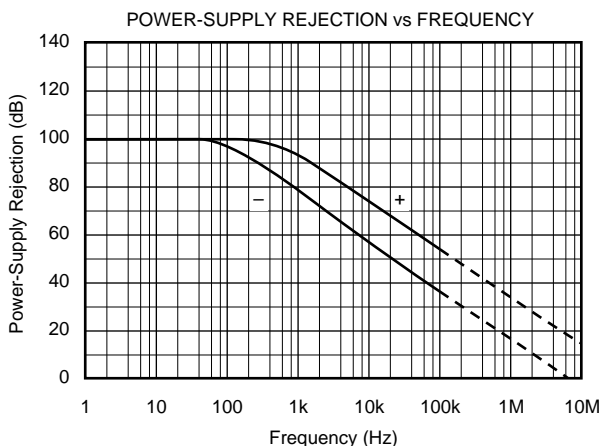

APPLICATIONS INFORMATION

Unity-gain stability with good phase margin and excellent output drive characteristics bring freedom from the subtle problems associated with other high-speed amplifiers. However, as with any high-speed, wide bandwidth circuitry, careful circuit layout will ensure best performance. Make short, direct interconnections and avoid stray wiring capacitance—especially at the inverting input pin.

Power supplies should be bypassed with good high-frequency capacitors positioned close to the op amp pins. In most cases $0.1\mu\text{F}$ ceramic capacitors are adequate. Applications with heavier loads and fast transient waveforms may benefit from use of additional $1.0\mu\text{F}$ tantalum bypass capacitors.

INPUT BIAS CURRENT GUARDING

Leakage currents across printed circuit boards can easily exceed the input bias current of the OPA602. A circuit board “guard” pattern, as shown in Figure 1, is an effective solution to difficult leakage problems. This guard pattern must be repeated on all layers of a multilayer board. By surrounding critical high impedance input circuitry with a low impedance circuit connection at the same potential, leakage currents will flow harmlessly to the low-impedance node.

Input bias current may also be degraded by improper handling or cleaning. Contamination from handling parts and circuit boards may be cleaned with appropriate solvents and deionized water. Each rinsing operation should be followed by a 30-minute bake at $+85^\circ\text{C}$.

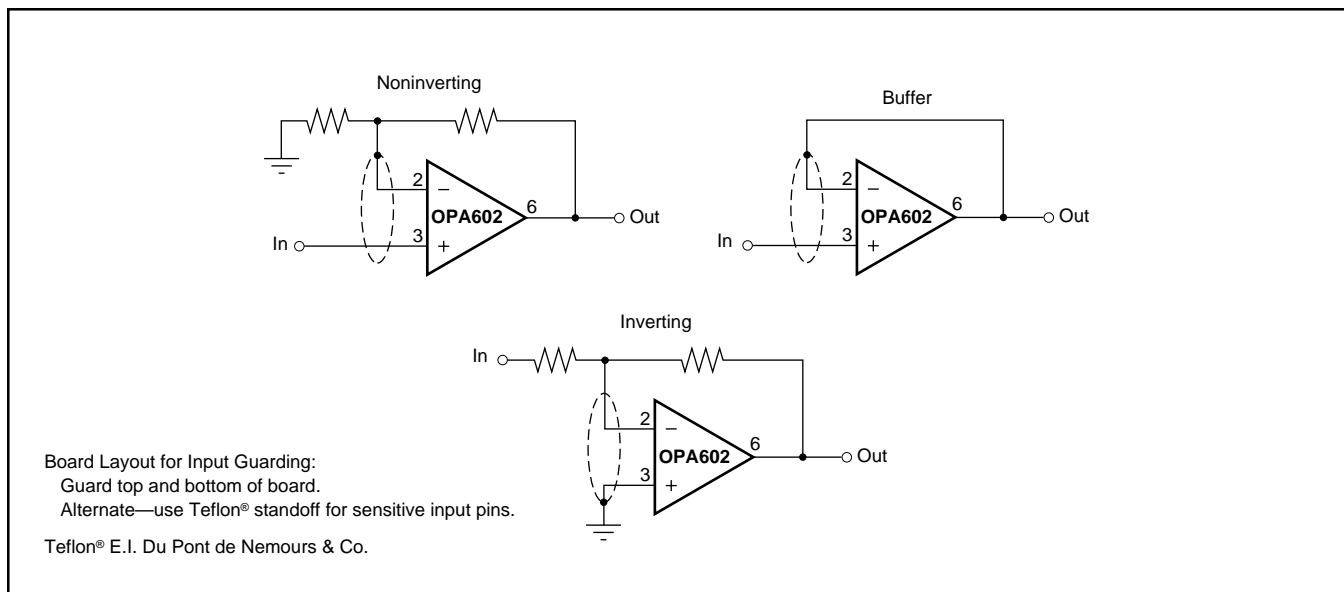

FIGURE 1. Connection of Input Guard.

APPLICATION CIRCUITS

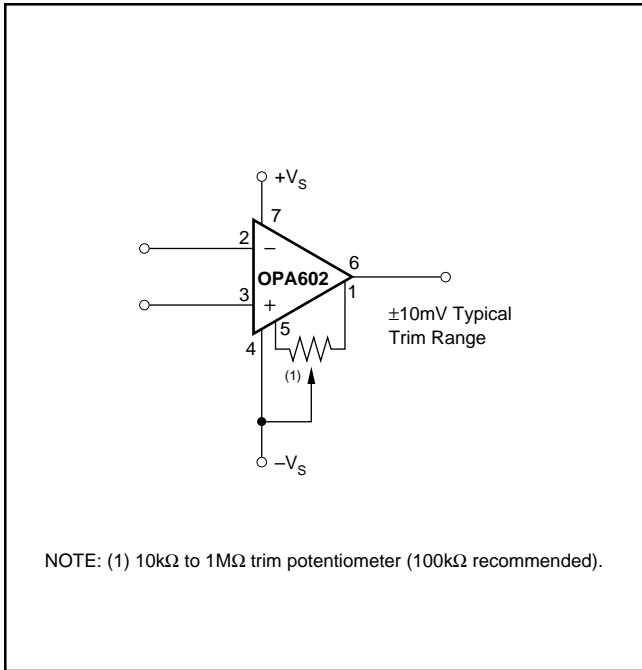

FIGURE 2. Offset Voltage Trim.

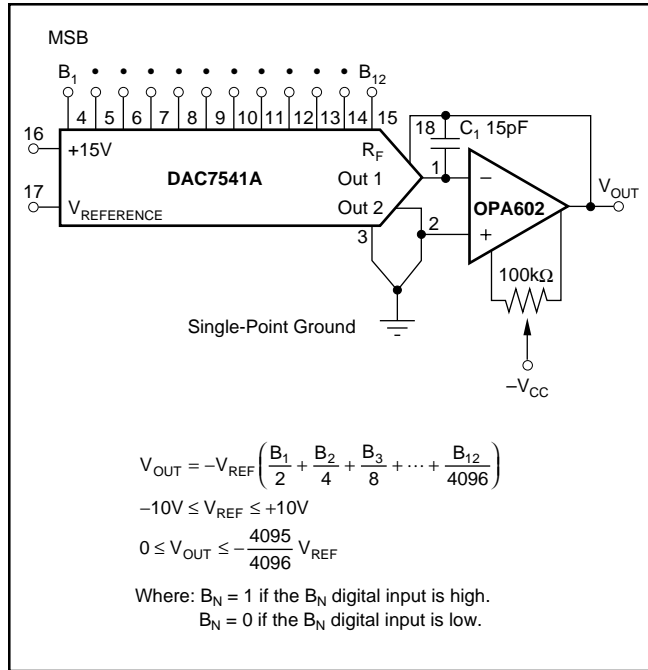

FIGURE 3. Voltage Output Digital-to-Analog Converter.

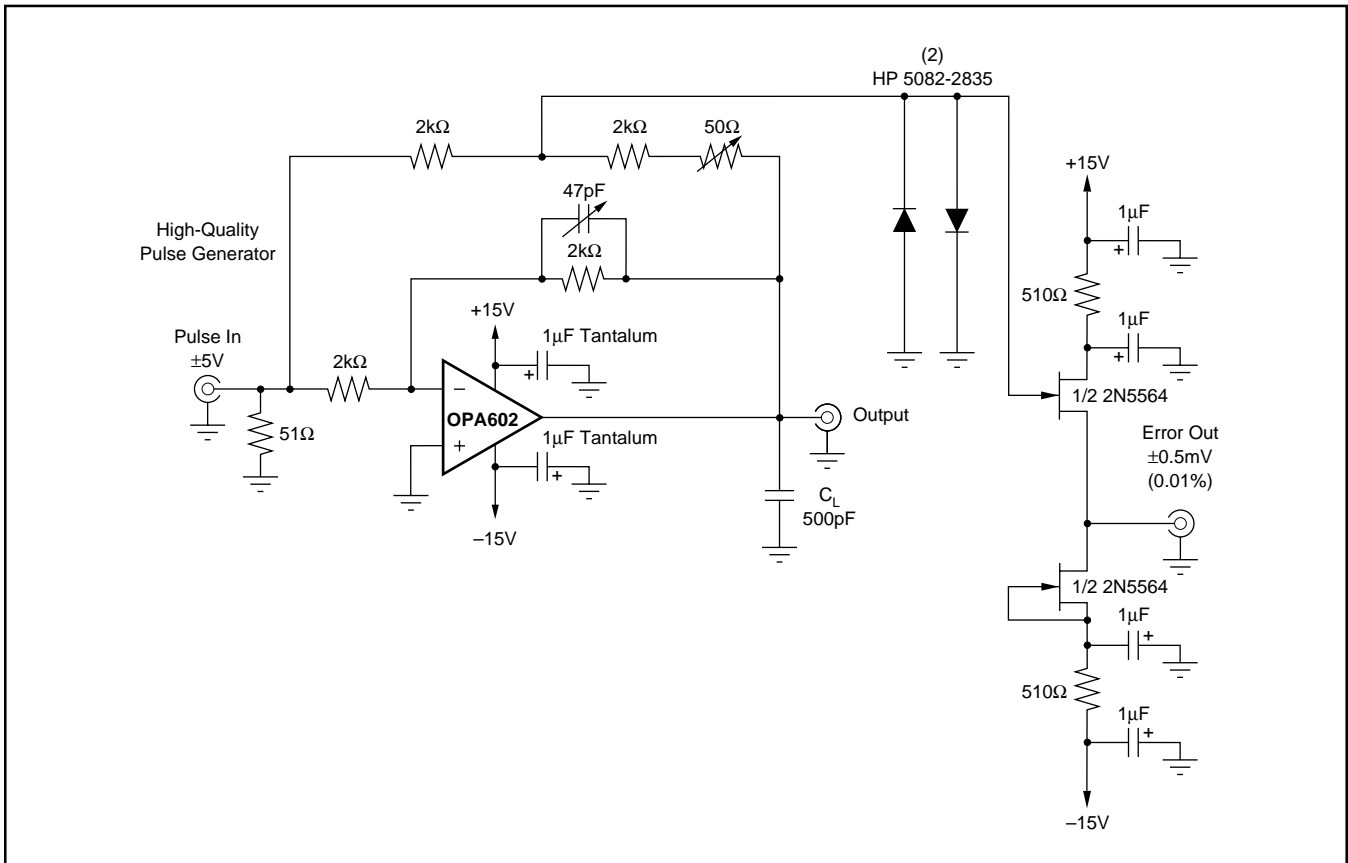
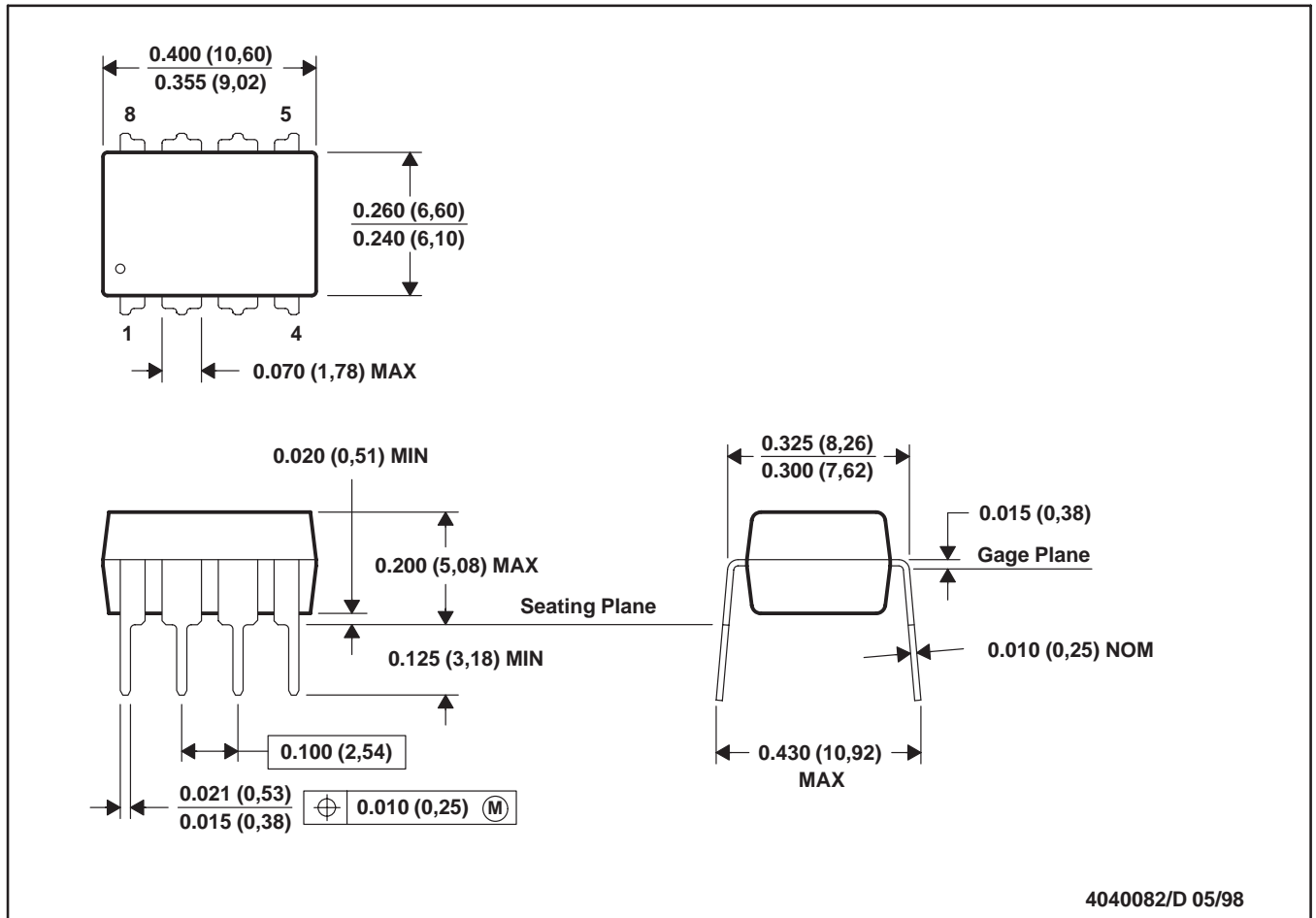

FIGURE 4. Settling Time and Slew Rate Test Circuit.



- NOTES: A. All linear dimensions are in inches (millimeters).
 B. This drawing is subject to change without notice.
 C. Falls within JEDEC MS-001

D (R-PDSO-G**)

PLASTIC SMALL-OUTLINE PACKAGE

8 PINS SHOWN

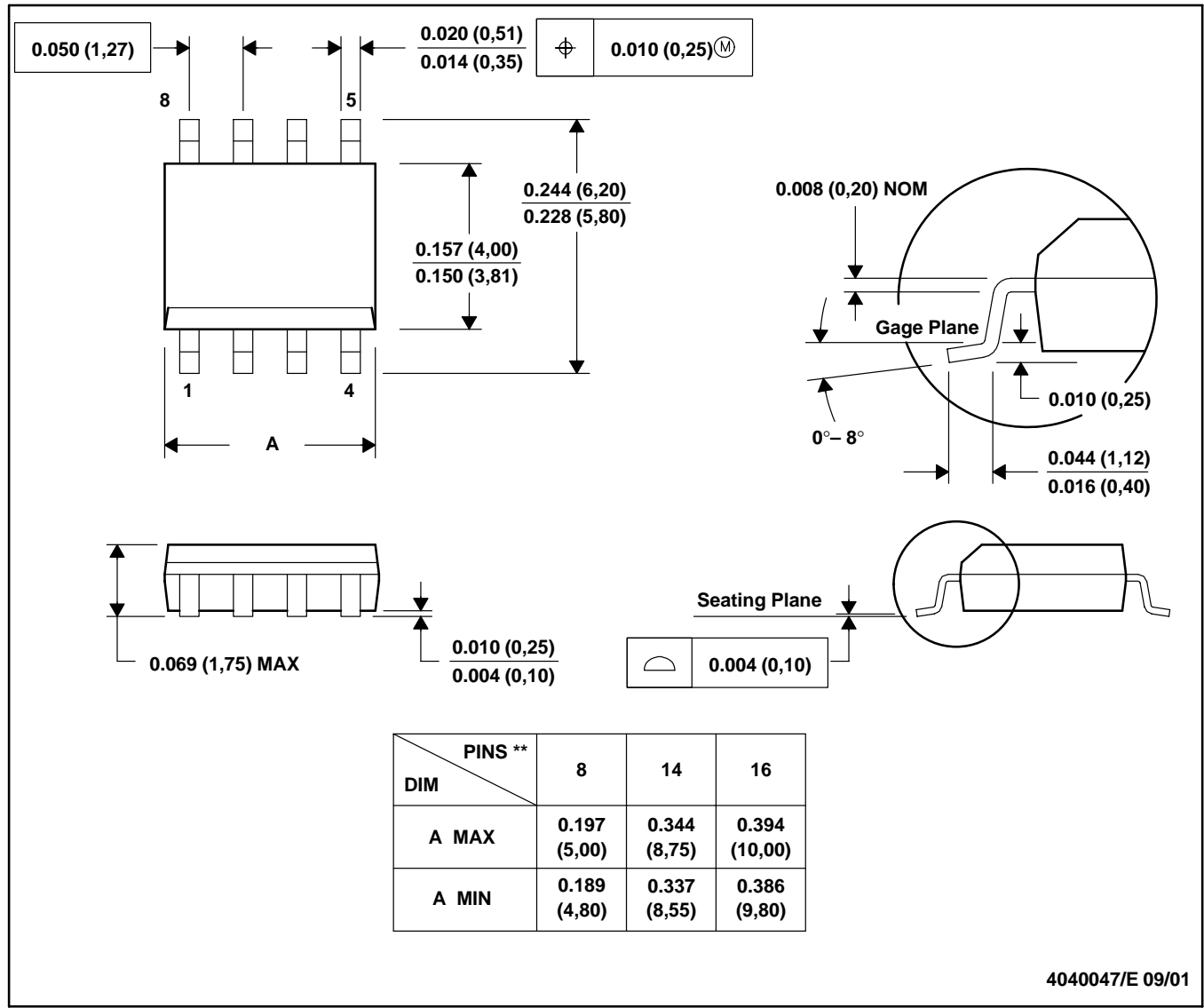

- NOTES: A. All linear dimensions are in inches (millimeters).
 B. This drawing is subject to change without notice.
 C. Body dimensions do not include mold flash or protrusion, not to exceed 0.006 (0,15).
 D. Falls within JEDEC MS-012

PACKAGING INFORMATION

Orderable Device	Status ⁽¹⁾	Package Type	Package Drawing	Pins	Package Qty	Eco Plan ⁽²⁾	Lead/Ball Finish	MSL Peak Temp ⁽³⁾
OPA602AM	OBSOLETE	TO-99	LMC	8		TBD	Call TI	Call TI
OPA602AM2	OBSOLETE	TO-99	LMC	8		TBD	Call TI	Call TI
OPA602AP	ACTIVE	PDIP	P	8	50	Green (RoHS & no Sb/Br)	CU NIPDAU	N / A for Pkg Type
OPA602APG4	ACTIVE	PDIP	P	8	50	Green (RoHS & no Sb/Br)	CU NIPDAU	N / A for Pkg Type
OPA602AU	ACTIVE	SOIC	D	8	75	Green (RoHS & no Sb/Br)	CU NIPDAU	Level-3-260C-168 HR
OPA602AU/2K5	ACTIVE	SOIC	D	8	2500	Green (RoHS & no Sb/Br)	CU NIPDAU	Level-3-260C-168 HR
OPA602AU/2K5E4	ACTIVE	SOIC	D	8	2500	Green (RoHS & no Sb/Br)	CU NIPDAU	Level-3-260C-168 HR
OPA602AUE4	ACTIVE	SOIC	D	8	75	Green (RoHS & no Sb/Br)	CU NIPDAU	Level-3-260C-168 HR
OPA602AUG4	ACTIVE	SOIC	D	8	75	Green (RoHS & no Sb/Br)	CU NIPDAU	Level-3-260C-168 HR
OPA602BM	OBSOLETE	TO-99	LMC	8		TBD	Call TI	Call TI
OPA602BM1	OBSOLETE	TO-99	LMC	8		TBD	Call TI	Call TI
OPA602BP	ACTIVE	PDIP	P	8	50	Green (RoHS & no Sb/Br)	CU NIPDAU	N / A for Pkg Type
OPA602BPG4	ACTIVE	PDIP	P	8	50	Green (RoHS & no Sb/Br)	CU NIPDAU	N / A for Pkg Type
OPA602CM	OBSOLETE	TO-99	LMC	8		TBD	Call TI	Call TI
OPA602SM	OBSOLETE	TO-99	LMC	8		TBD	Call TI	Call TI

⁽¹⁾ The marketing status values are defined as follows:

ACTIVE: Product device recommended for new designs.

LIFEBUY: TI has announced that the device will be discontinued, and a lifetime-buy period is in effect.

NRND: Not recommended for new designs. Device is in production to support existing customers, but TI does not recommend using this part in a new design.

PREVIEW: Device has been announced but is not in production. Samples may or may not be available.

OBSOLETE: TI has discontinued the production of the device.

⁽²⁾ Eco Plan - The planned eco-friendly classification: Pb-Free (RoHS), Pb-Free (RoHS Exempt), or Green (RoHS & no Sb/Br) - please check <http://www.ti.com/productcontent> for the latest availability information and additional product content details.

TBD: The Pb-Free/Green conversion plan has not been defined.

Pb-Free (RoHS): TI's terms "Lead-Free" or "Pb-Free" mean semiconductor products that are compatible with the current RoHS requirements for all 6 substances, including the requirement that lead not exceed 0.1% by weight in homogeneous materials. Where designed to be soldered at high temperatures, TI Pb-Free products are suitable for use in specified lead-free processes.

Pb-Free (RoHS Exempt): This component has a RoHS exemption for either 1) lead-based flip-chip solder bumps used between the die and package, or 2) lead-based die adhesive used between the die and leadframe. The component is otherwise considered Pb-Free (RoHS compatible) as defined above.

Green (RoHS & no Sb/Br): TI defines "Green" to mean Pb-Free (RoHS compatible), and free of Bromine (Br) and Antimony (Sb) based flame retardants (Br or Sb do not exceed 0.1% by weight in homogeneous material)

⁽³⁾ MSL, Peak Temp. -- The Moisture Sensitivity Level rating according to the JEDEC industry standard classifications, and peak solder temperature.

Important Information and Disclaimer: The information provided on this page represents TI's knowledge and belief as of the date that it is provided. TI bases its knowledge and belief on information provided by third parties, and makes no representation or warranty as to the accuracy of such information. Efforts are underway to better integrate information from third parties. TI has taken and continues to take reasonable steps to provide representative and accurate information but may not have conducted destructive testing or chemical analysis on incoming materials and chemicals. TI and TI suppliers consider certain information to be proprietary, and thus CAS numbers and other limited

information may not be available for release.

In no event shall TI's liability arising out of such information exceed the total purchase price of the TI part(s) at issue in this document sold by TI to Customer on an annual basis.

TAPE AND REEL INFORMATION



QUADRANT ASSIGNMENTS FOR PIN 1 ORIENTATION IN TAPE



*All dimensions are nominal

Device	Package Type	Package Drawing	Pins	SPQ	Reel Diameter (mm)	Reel Width W1 (mm)	A0 (mm)	B0 (mm)	K0 (mm)	P1 (mm)	W (mm)	Pin1 Quadrant
OPA602AU/2K5	SOIC	D	8	2500	330.0	12.4	6.4	5.2	2.1	8.0	12.0	Q1

TAPE AND REEL BOX DIMENSIONS



*All dimensions are nominal

Device	Package Type	Package Drawing	Pins	SPQ	Length (mm)	Width (mm)	Height (mm)
OPA602AU/2K5	SOIC	D	8	2500	346.0	346.0	29.0

IMPORTANT NOTICE

Texas Instruments Incorporated and its subsidiaries (TI) reserve the right to make corrections, modifications, enhancements, improvements, and other changes to its products and services at any time and to discontinue any product or service without notice. Customers should obtain the latest relevant information before placing orders and should verify that such information is current and complete. All products are sold subject to TI's terms and conditions of sale supplied at the time of order acknowledgment.

TI warrants performance of its hardware products to the specifications applicable at the time of sale in accordance with TI's standard warranty. Testing and other quality control techniques are used to the extent TI deems necessary to support this warranty. Except where mandated by government requirements, testing of all parameters of each product is not necessarily performed.

TI assumes no liability for applications assistance or customer product design. Customers are responsible for their products and applications using TI components. To minimize the risks associated with customer products and applications, customers should provide adequate design and operating safeguards.

TI does not warrant or represent that any license, either express or implied, is granted under any TI patent right, copyright, mask work right, or other TI intellectual property right relating to any combination, machine, or process in which TI products or services are used. Information published by TI regarding third-party products or services does not constitute a license from TI to use such products or services or a warranty or endorsement thereof. Use of such information may require a license from a third party under the patents or other intellectual property of the third party, or a license from TI under the patents or other intellectual property of TI.

Reproduction of TI information in TI data books or data sheets is permissible only if reproduction is without alteration and is accompanied by all associated warranties, conditions, limitations, and notices. Reproduction of this information with alteration is an unfair and deceptive business practice. TI is not responsible or liable for such altered documentation. Information of third parties may be subject to additional restrictions.

Resale of TI products or services with statements different from or beyond the parameters stated by TI for that product or service voids all express and any implied warranties for the associated TI product or service and is an unfair and deceptive business practice. TI is not responsible or liable for any such statements.

TI products are not authorized for use in safety-critical applications (such as life support) where a failure of the TI product would reasonably be expected to cause severe personal injury or death, unless officers of the parties have executed an agreement specifically governing such use. Buyers represent that they have all necessary expertise in the safety and regulatory ramifications of their applications, and acknowledge and agree that they are solely responsible for all legal, regulatory and safety-related requirements concerning their products and any use of TI products in such safety-critical applications, notwithstanding any applications-related information or support that may be provided by TI. Further, Buyers must fully indemnify TI and its representatives against any damages arising out of the use of TI products in such safety-critical applications.

TI products are neither designed nor intended for use in military/aerospace applications or environments unless the TI products are specifically designated by TI as military-grade or "enhanced plastic." Only products designated by TI as military-grade meet military specifications. Buyers acknowledge and agree that any such use of TI products which TI has not designated as military-grade is solely at the Buyer's risk, and that they are solely responsible for compliance with all legal and regulatory requirements in connection with such use.

TI products are neither designed nor intended for use in automotive applications or environments unless the specific TI products are designated by TI as compliant with ISO/TS 16949 requirements. Buyers acknowledge and agree that, if they use any non-designated products in automotive applications, TI will not be responsible for any failure to meet such requirements.

Following are URLs where you can obtain information on other Texas Instruments products and application solutions:

Products

Amplifiers	amplifier.ti.com
Data Converters	dataconverter.ti.com
DLP® Products	www.dlp.com
DSP	dsp.ti.com
Clocks and Timers	www.ti.com/clocks
Interface	interface.ti.com
Logic	logic.ti.com
Power Mgmt	power.ti.com
Microcontrollers	microcontroller.ti.com
RFID	www.ti-rfid.com
RF/IF and ZigBee® Solutions	www.ti.com/lprf

Applications

Audio	www.ti.com/audio
Automotive	www.ti.com/automotive
Broadband	www.ti.com/broadband
Digital Control	www.ti.com/digitalcontrol
Medical	www.ti.com/medical
Military	www.ti.com/military
Optical Networking	www.ti.com/opticalnetwork
Security	www.ti.com/security
Telephony	www.ti.com/telephony
Video & Imaging	www.ti.com/video
Wireless	www.ti.com/wireless

Mailing Address: Texas Instruments, Post Office Box 655303, Dallas, Texas 75265
Copyright © 2009, Texas Instruments Incorporated

Looking for pricing, stock, or lifecycle information?

Click below to explore more details on WIN SOURCE:

 [View OPA602AP](#) on WIN SOURCE

 [Texas Instruments](#) Information

Optimize Your Supply Chain with WIN SOURCE Solutions

-  Global Sourcing Solution
-  Obsolete Management
-  Cost Control Management
-  Shortage Management
-  Alternative Solution
-  Excess Inventory Management