



# THE DATASHEET OF OPA2373AIDGSR



## OPAx373, OPAx374 6.5-MHz, 585- $\mu$ A, Rail-to-Rail I/O CMOS Operational Amplifier

### 1 Features

- Low Offset: 5 mV (Maximum)
- Low  $I_B$ : 10 pA (Maximum)
- High Bandwidth: 6.5 MHz
- Rail-to-Rail Input and Output
- Single Supply: 2.3 V to 5.5 V
- Shutdown: OPAx373
- Specified up to 125°C
- *Microsize Packages*: 5-Pin SOT-23, 6-Pin SOT-23, 8-Pin SOT-23, and 10-Pin VSON

### 2 Applications

- Portable Equipment
- Battery-Powered Devices
- Active Filters
- Driving A/D Converters

### 3 Description

The OPA373 and OPA374 families of operational amplifiers are low power and low cost with excellent bandwidth (6.5 MHz) and slew rate (5 V/ $\mu$ s). The input range extends 200 mV beyond the rails and the output range is within 25 mV of the rails. The speed-power ratio and small size make them ideal for portable and battery-powered applications.

The OPA373 family includes a shutdown mode. Under logic control, the amplifiers can be switched from normal operation to a standby current that is less than 1  $\mu$ A.

The OPA373 and OPA374 families of operational amplifiers are specified for single or dual power supplies of 2.7 V to 5.5 V, with operation from 2.3 V to 5.5 V. All models are specified for  $-40^\circ\text{C}$  to 125°C.

#### Device Information<sup>(1)</sup>

PART NUMBER	PACKAGE	BODY SIZE (NOM)
OPA373	SOIC (8)	4.90 mm x 3.91 mm
	SOT-23 (6)	2.90 mm x 1.60 mm
OPA374	SOIC (8)	4.90 mm x 3.91 mm
	SOT-23 (5)	2.90 mm x 1.60 mm
OPA2373	VSON (10)	3.00 mm x 3.00 mm
	VSSOP (10)	3.00 mm x 3.00 mm
OPA2374	SOIC (8)	4.90 mm x 3.91 mm
	SOT-23 (8)	2.90 mm x 1.63 mm
OPA4374	SOIC (14)	8.65 mm x 3.91 mm
	TSSOP (14)	5.00 mm x 4.40 mm

(1) For all available packages, see the orderable addendum at the end of the data sheet.

#### Typical Application

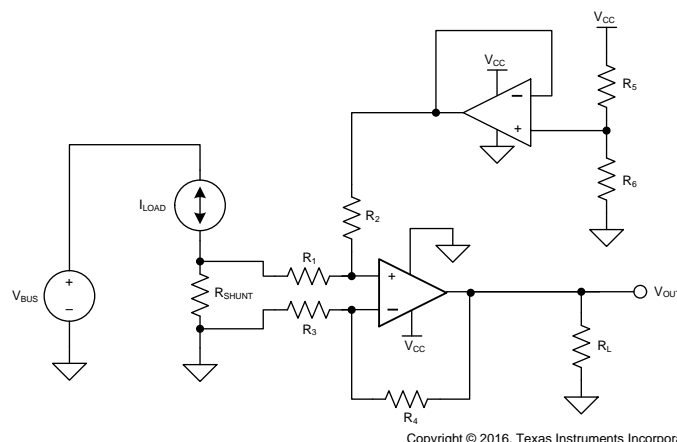

Copyright © 2016, Texas Instruments Incorporated



## Table of Contents

<b>1 Features</b> .....	<b>1</b>	8.3 Feature Description.....	<b>15</b>
<b>2 Applications</b> .....	<b>1</b>	8.4 Device Functional Modes.....	<b>18</b>
<b>3 Description</b> .....	<b>1</b>	<b>9 Application and Implementation</b> .....	<b>19</b>
<b>4 Revision History</b> .....	<b>2</b>	9.1 Application Information.....	<b>19</b>
<b>5 Device Comparison Table</b> .....	<b>3</b>	9.2 Typical Application .....	<b>19</b>
<b>6 Pin Configuration and Functions</b> .....	<b>4</b>	9.3 System Examples .....	<b>21</b>
<b>7 Specifications</b> .....	<b>7</b>	<b>10 Power Supply Recommendations</b> .....	<b>23</b>
7.1 Absolute Maximum Ratings .....	<b>7</b>	<b>11 Layout</b> .....	<b>23</b>
7.2 ESD Ratings.....	<b>7</b>	11.1 Layout Guidelines .....	<b>23</b>
7.3 Recommended Operating Conditions.....	<b>7</b>	11.2 Layout Example .....	<b>24</b>
7.4 Thermal Information: OPA373 .....	<b>7</b>	<b>12 Device and Documentation Support</b> .....	<b>25</b>
7.5 Thermal Information: OPA374 .....	<b>8</b>	12.1 Device Support.....	<b>25</b>
7.6 Thermal Information: OPA2373 .....	<b>8</b>	12.2 Documentation Support .....	<b>26</b>
7.7 Thermal Information: OPA2374 .....	<b>8</b>	12.3 Related Links .....	<b>26</b>
7.8 Thermal Information: OPA4374 .....	<b>8</b>	12.4 Receiving Notification of Documentation Updates	<b>26</b>
7.9 Electrical Characteristics: $V_S = 2.7\text{ V to }5.5\text{ V}$ .....	<b>9</b>	12.5 Community Resources.....	<b>26</b>
7.10 Typical Characteristics .....	<b>11</b>	12.6 Trademarks .....	<b>26</b>
<b>8 Detailed Description</b> .....	<b>15</b>	12.7 Electrostatic Discharge Caution.....	<b>26</b>
8.1 Overview .....	<b>15</b>	12.8 Glossary.....	<b>27</b>
8.2 Functional Block Diagram .....	<b>15</b>	<b>13 Mechanical, Packaging, and Orderable Information</b> .....	<b>27</b>

## 4 Revision History

Changes from Revision E (May 2008) to Revision F	Page
• Added <i>ESD Rating</i> table, <i>Feature Description</i> section, <i>Device Functional Modes</i> , <i>Application and Implementation</i> section, <i>Power Supply Recommendations</i> section, <i>Layout</i> section, <i>Device and Documentation Support</i> section, and <i>Mechanical, Packaging, and Orderable Information</i> section .....	<b>1</b>
• Deleted <i>Package/Ordering Information</i> table; refer to <i>Package Option Addendum</i> at the end of this data sheet .....	<b>4</b>
• Deleted <i>lead temperature</i> specification from <i>Absolute Maximum Ratings</i> .....	<b>7</b>
• Changed values in the <i>Thermal Information</i> tables to align with JEDEC standards.....	<b>7</b>

## 5 Device Comparison Table

DEVICE	NO. OF CHANNELS	SHUTDOWN	PACKAGE-PIN				
			SOIC	SOT-23	VSON	VSSOP	TSSOP
OPA373	1	Yes	8	6	—	—	—
OPA2373	2	Yes	—	—	10	10	—
OPA374	1	No	8	5	—	—	—
OPA2374	2	No	8	8	—	—	—
OPA4374	4	No	14	—	—	—	14

## 6 Pin Configuration and Functions

**OPA373: DBV Package  
6-Pin SOT-23  
Top View**

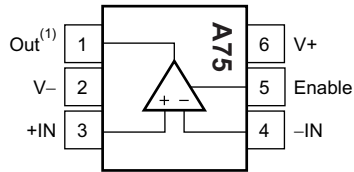

(1) Pin 1 of the 6-pin SOT-23 is determined by orienting the package marking as shown.

**OPA373: D Package  
8-Pin SOIC  
Top View**



(2) NC indicates no internal connection.

### Pin Functions: OPA373

NAME	PIN		I/O	DESCRIPTION
	SOIC	SOT-23		
Enable	8	5	I	Enable
-IN	2	4	I	Negative (inverting) input
+IN	3	3	I	Positive (noninverting) input
NC	1, 5	—	—	No internal connection (can be left floating)
OUT	6	1	O	Output
V-	4	2	—	Negative (lowest) power supply
V+	7	6	—	Positive (highest) power supply

**OPA2373: DGS Package  
10-Pin VSON  
Top View**



**OPA2373: DRC Package  
10-Pin VSSOP  
Top View**

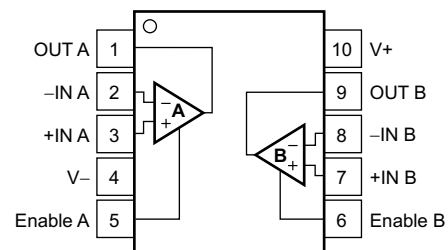

### Pin Functions: OPA2373

NAME	PIN		I/O	DESCRIPTION
	VSON	VSSOP		
Enable A	5	5	I	Enable A amplifier
Enable B	6	6	I	Enable B amplifier
-IN A	2	2	I	Inverting input, channel A
+IN A	3	3	I	Noninverting input, channel A
-IN B	8	8	I	Inverting input, channel B
+IN B	7	7	I	Noninverting input, channel B
OUT A	1	1	O	Output, channel A
OUT B	9	9	O	Output, channel B
V-	4	4	—	Negative (lowest) power supply
V+	10	10	—	Positive (highest) power supply

OPA374: DBV Package  
5-Pin SOT-23  
Top View



OPA374: D Package  
8-Pin SOIC  
Top View

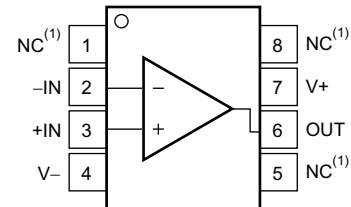

(1) NC indicates no internal connection.

Pin Functions: OPA374

NAME	PIN		I/O	DESCRIPTION
	SOIC	SOT-23		
-IN	2	4	I	Negative (inverting) input
+IN	3	3	I	Positive (noninverting) input
NC	1, 5, 8	—	—	No internal connection (can be left floating)
OUT	6	1	O	Output
V-	4	2	—	Negative (lowest) power supply
V+	7	5	—	Positive (highest) power supply

OPA2374: DCN Package  
8-Pin SOT-23  
Top View

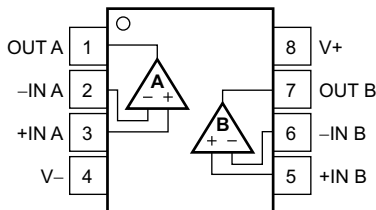

OPA2374: D Package  
8-Pin SOIC  
Top View



Pin Functions: OPA2374

NAME	PIN		I/O	DESCRIPTION
	SOIC	SOT-23		
-IN A	2	2	I	Inverting input, channel A
+IN A	3	3	I	Noninverting input, channel A
-IN B	6	6	I	Inverting input, channel B
+IN B	5	5	I	Noninverting input, channel B
OUT A	1	1	O	Output, channel A
OUT B	7	7	O	Output, channel B
V-	4	4	—	Negative (lowest) power supply
V+	8	8	—	Positive (highest) power supply

OPA4374: PW Package  
 14-Pin TSSOP  
 Top View



OPA4374: D Package  
 14-Pin SOIC  
 Top View



**Pin Functions: OPA4374**

NAME	PIN		I/O	DESCRIPTION
	SOIC	TSSOP		
-IN A	2	2	I	Inverting input, channel A
+IN A	3	3	I	Noninverting input, channel A
-IN B	6	6	I	Inverting input, channel B
+IN B	5	5	I	Noninverting input, channel B
-IN C	9	9	I	Inverting input, channel C
+IN C	10	10	I	Noninverting input, channel C
-IN D	13	13	I	Inverting input, channel D
+IN D	12	12	I	Noninverting input, channel D
OUT A	1	1	O	Output, channel A
OUT B	7	7	O	Output, channel B
OUT C	8	8	O	Output, channel C
OUT D	14	14	O	Output, channel D
V-	11	11	—	Negative (lowest) power supply
V+	4	4	—	Positive (highest) power supply

## 7 Specifications

### 7.1 Absolute Maximum Ratings

over operating free-air temperature range (unless otherwise noted)<sup>(1)</sup>

		MIN	MAX	UNIT
Voltage	Supply		7	V
	Signal input pin <sup>(2)</sup>	-0.5	(V+) + 0.5	
Current	Signal input pin <sup>(2)</sup>	-10	10	mA
	Output short-circuit <sup>(3)</sup>	Continuous		
Temperature	Operating, T <sub>A</sub>	-55	150	°C
	Junction, T <sub>J</sub>		150	
	Storage, T <sub>stg</sub>	-65	150	

- (1) Stresses beyond those listed under *Absolute Maximum Ratings* may cause permanent damage to the device. These are stress ratings only, which do not imply functional operation of the device at these or any other conditions beyond those indicated under *Recommended Operating Conditions*. Exposure to absolute-maximum-rated conditions for extended periods may affect device reliability.
- (2) Input terminals are diode-clamped to the power-supply rails. Input signals that can swing more than 0.5 V beyond the supply rails must be current limited to 10 mA or less.
- (3) Short-circuit to ground, one amplifier per package.

### 7.2 ESD Ratings

		VALUE	UNIT
V <sub>(ESD)</sub> Electrostatic discharge	Human-body model (HBM), per ANSI/ESDA/JEDEC JS-001 <sup>(1)</sup>	±3000	V
	Charged-device model (CDM), per JEDEC specification JESD22-C101 <sup>(2)</sup>	±1000	

- (1) JEDEC document JEP155 states that 500-V HBM allows safe manufacturing with a standard ESD control process.
- (2) JEDEC document JEP157 states that 250-V CDM allows safe manufacturing with a standard ESD control process.

### 7.3 Recommended Operating Conditions

over operating free-air temperature range (unless otherwise noted)

		MIN	MAX	UNIT
	Supply voltage	±1.35 (2.7)	±2.75 (5.5)	V
T <sub>A</sub>	Operating temperature	-40	125	°C

### 7.4 Thermal Information: OPA373

THERMAL METRIC <sup>(1)</sup>		OPA373		UNIT
		D (SOIC)	DBV (SOT-23)	
		8 PINS	6 PINS	
R <sub>θJA</sub>	Junction-to-ambient thermal resistance	128.4	184.3	°C/W
R <sub>θJC(top)</sub>	Junction-to-case (top) thermal resistance	76.7	146.2	°C/W
R <sub>θJB</sub>	Junction-to-board thermal resistance	68.8	36.4	°C/W
ψ <sub>JT</sub>	Junction-to-top characterization parameter	27.9	33.6	°C/W
ψ <sub>JB</sub>	Junction-to-board characterization parameter	68.3	35.9	°C/W
R <sub>θJC(bot)</sub>	Junction-to-case (bottom) thermal resistance	—	—	°C/W

- (1) For more information about traditional and new thermal metrics, see the [Semiconductor and IC Package Thermal Metrics](#) application report.

## 7.5 Thermal Information: OPA374

THERMAL METRIC <sup>(1)</sup>		OPA374		UNIT
		D (SOIC)	DBV (SOT-23)	
		8 PINS	5 PINS	
$R_{\theta JA}$	Junction-to-ambient thermal resistance	125.1	220.1	°C/W
$R_{\theta JC(top)}$	Junction-to-case (top) thermal resistance	71.7	129	°C/W
$R_{\theta JB}$	Junction-to-board thermal resistance	65.5	46.4	°C/W
$\Psi_{JT}$	Junction-to-top characterization parameter	26.2	21	°C/W
$\Psi_{JB}$	Junction-to-board characterization parameter	65	45.4	°C/W
$R_{\theta JC(bot)}$	Junction-to-case (bottom) thermal resistance	—	—	°C/W

(1) For more information about traditional and new thermal metrics, see the [Semiconductor and IC Package Thermal Metrics](#) application report.

## 7.6 Thermal Information: OPA2373

THERMAL METRIC <sup>(1)</sup>		OPA2373		UNIT
		DGS (VSON)	DRC (VSSOP)	
		10 PINS	10 PINS	
$R_{\theta JA}$	Junction-to-ambient thermal resistance	170.6	56.4	°C/W
$R_{\theta JC(top)}$	Junction-to-case (top) thermal resistance	59.8	76.7	°C/W
$R_{\theta JB}$	Junction-to-board thermal resistance	91	30.6	°C/W
$\Psi_{JT}$	Junction-to-top characterization parameter	10.4	3.7	°C/W
$\Psi_{JB}$	Junction-to-board characterization parameter	89.6	30.7	°C/W
$R_{\theta JC(bot)}$	Junction-to-case (bottom) thermal resistance	—	11.4	°C/W

(1) For more information about traditional and new thermal metrics, see the [Semiconductor and IC Package Thermal Metrics](#) application report.

## 7.7 Thermal Information: OPA2374

THERMAL METRIC <sup>(1)</sup>		OPA2374		UNIT
		D (SOIC)	DCN (SOT-23)	
		8 PINS	8 PINS	
$R_{\theta JA}$	Junction-to-ambient thermal resistance	117.8	171.3	°C/W
$R_{\theta JC(top)}$	Junction-to-case (top) thermal resistance	63.1	73.5	°C/W
$R_{\theta JB}$	Junction-to-board thermal resistance	58.4	106.3	°C/W
$\Psi_{JT}$	Junction-to-top characterization parameter	19.3	15.4	°C/W
$\Psi_{JB}$	Junction-to-board characterization parameter	57.9	105.5	°C/W
$R_{\theta JC(bot)}$	Junction-to-case (bottom) thermal resistance	—	—	°C/W

(1) For more information about traditional and new thermal metrics, see the [Semiconductor and IC Package Thermal Metrics](#) application report.

## 7.8 Thermal Information: OPA4374

THERMAL METRIC <sup>(1)</sup>		OPA4374		UNIT
		D (SOIC)	PW (TSSOP)	
		14 PINS	14 PINS	
$R_{\theta JA}$	Junction-to-ambient thermal resistance	86.5	112.7	°C/W
$R_{\theta JC(top)}$	Junction-to-case (top) thermal resistance	45	34.1	°C/W
$R_{\theta JB}$	Junction-to-board thermal resistance	41.1	57.1	°C/W
$\Psi_{JT}$	Junction-to-top characterization parameter	12.3	2.9	°C/W
$\Psi_{JB}$	Junction-to-board characterization parameter	40.8	56.1	°C/W
$R_{\theta JC(bot)}$	Junction-to-case (bottom) thermal resistance	—	—	°C/W

(1) For more information about traditional and new thermal metrics, see the [Semiconductor and IC Package Thermal Metrics](#) application report.

## 7.9 Electrical Characteristics: $V_S = 2.7\text{ V to }5.5\text{ V}$

At  $T_A = 25^\circ\text{C}$ ,  $R_L = 10\text{ k}\Omega$  connected to  $V_S/2$ , and  $V_{OUT} = V_S/2$  (unless otherwise noted)

PARAMETER		TEST CONDITIONS		MIN	TYP	MAX	UNIT
<b>OFFSET VOLTAGE</b>							
$V_{OS}$	Input offset voltage	$V_S = 5\text{ V}$			1	5	mV
	Input offset voltage versus temperature	$T_A = -40^\circ\text{C to }125^\circ\text{C}$				6.5	mV
$dV_{OS}/dT$	Input offset voltage versus drift	$T_A = -40^\circ\text{C to }+125^\circ\text{C}$			3		$\mu\text{V}/^\circ\text{C}$
PSRR	Input offset voltage versus power supply	$V_S = 2.7\text{ V to }5.5\text{ V}$ , $V_{CM} < (V+) - 2\text{ V}$	$T_A = 25^\circ\text{C}$		25	100	$\mu\text{V}/\text{V}$
			$T_A = -40^\circ\text{C to }125^\circ\text{C}$			150	
	Channel separation, DC				0.4		$\mu\text{V}/\text{V}$
		At $f = 1\text{ kHz}$			128		dB
<b>INPUT VOLTAGE</b>							
$V_{CM}$	Common-mode voltage range			$(V-) - 0.2$		$(V+) + 0.2$	V
CMRR	Common-mode rejection ratio	$(V-) - 0.2\text{ V} < V_{CM} < (V+) - 2\text{ V}$	$T_A = 25^\circ\text{C}$	80	90		dB
			$T_A = -40^\circ\text{C to }125^\circ\text{C}$	70			
		$V_S = 5.5\text{ V}$ , $(V-) - 0.2\text{ V} < V_{CM} < (V+) + 0.2\text{ V}$	$T_A = 25^\circ\text{C}$	66			dB
			$T_A = -40^\circ\text{C to }125^\circ\text{C}$	60			dB
<b>INPUT BIAS CURRENT</b>							
$I_B$	Input bias current				$\pm 0.5$	$\pm 10$	pA
$I_{OS}$	Input offset current				$\pm 0.5$	$\pm 10$	pA
<b>INPUT IMPEDANCE</b>							
	Differential				$10^{13} \parallel 3$		$\Omega \parallel \text{pF}$
	Common-mode				$10^{13} \parallel 6$		$\Omega \parallel \text{pF}$
<b>NOISE</b>							
	Input voltage noise	$V_{CM} < (V+) - 2\text{ V}$ , $f = 0.1\text{ Hz to }10\text{ Hz}$			10		$\mu\text{V}_{PP}$
$e_n$	Input voltage noise density	$V_{CM} < (V+) - 2\text{ V}$ , $f = 10\text{ kHz}$			15		$\text{nV}/\sqrt{\text{Hz}}$
$i_n$	Input current noise density	$V_{CM} < (V+) - 2\text{ V}$ , $f = 10\text{ kHz}$			4		$\text{fA}/\sqrt{\text{Hz}}$
<b>OPEN-LOOP GAIN</b>							
$A_{OL}$	Open-loop voltage gain	$V_S = 5\text{ V}$ , $R_L = 100\text{ k}\Omega$ , $0.025\text{ V} < V_O < 4.975\text{ V}$	$T_A = 25^\circ\text{C}$	94	110		dB
			$T_A = -40^\circ\text{C to }125^\circ\text{C}$	80			
		$V_S = 5\text{ V}$ , $R_L = 5\text{ k}\Omega$ , $0.125\text{ V} < V_O < 4.875\text{ V}$	$T_A = 25^\circ\text{C}$	94	106		dB
			$T_A = -40^\circ\text{C to }125^\circ\text{C}$	80			
<b>OUTPUT</b>							
	Voltage output swing from rail	$R_L = 100\text{ k}\Omega$	$T_A = 25^\circ\text{C}$		18	25	mV
			$T_A = -40^\circ\text{C to }125^\circ\text{C}$			25	mV
		$R_L = 5\text{ k}\Omega$	$T_A = 25^\circ\text{C}$		100	125	mV
			$T_A = -40^\circ\text{C to }125^\circ\text{C}$			125	mV
$I_{SC}$	Short-circuit current			See <a href="#">Typical Characteristics</a>			
$C_{LOAD}$	Capacitive load drive			See <a href="#">Typical Characteristics</a>			
$R_O$	Open-loop output impedance	$f = 1\text{ MHz}$ , $I_O = 0\text{ mA}$			220		$\Omega$

### Electrical Characteristics: $V_S = 2.7\text{ V to }5.5\text{ V}$ (continued)

At  $T_A = 25^\circ\text{C}$ ,  $R_L = 10\text{ k}\Omega$  connected to  $V_S/2$ , and  $V_{OUT} = V_S/2$  (unless otherwise noted)

PARAMETER		TEST CONDITIONS	MIN	TYP	MAX	UNIT
<b>FREQUENCY RESPONSE</b>						
GBW	Gain-bandwidth product	$C_L = 100\text{ pF}$		6.5		MHz
SR	Slew rate	$C_L = 100\text{ pF}$ , $G = +1$		5		V/ $\mu\text{s}$
$t_S$	Settling time	0.1%, $C_L = 100\text{ pF}$ , $V_S = 5\text{ V}$ , 2-V step, $G = +1$		1		$\mu\text{s}$
		0.01%, $C_L = 100\text{ pF}$ , $V_S = 5\text{ V}$ , 2-V step, $G = +1$		1.5		$\mu\text{s}$
	Overload recovery time	$C_L = 100\text{ pF}$ , $V_{IN} \bullet \text{Gain} > V_S$		0.3		$\mu\text{s}$
THD+N	Total harmonic distortion + noise	$C_L = 100\text{ pF}$ , $V_S = 5\text{ V}$ , $V_O = 3\text{ V}_{PP}$ , $G = +1$ , $f = 1\text{ kHz}$		0.0013%		
<b>ENABLE OR SHUTDOWN</b>						
$t_{OFF}$	Turnoff time			3		$\mu\text{s}$
$t_{ON}$	Turnon time			12		$\mu\text{s}$
$V_L$	Logic low threshold	Shutdown	$V^-$		$(V^-) + 0.8$	V
$V_H$	Logic high threshold	Amplifier is active	$(V^-) + 2$		$V^+$	V
	Input bias current of Enable pin			0.2		$\mu\text{A}$
$I_{Q(sd)}$	Quiescent current at shutdown (per amplifier)			< 0.5	1	$\mu\text{A}$
<b>POWER SUPPLY</b>						
$V_S$	Specified voltage range		2.7		5.5	V
	Operating voltage range			2.3 to 5.5		V
$I_Q$	Quiescent current (per amplifier)	$I_O = 0\text{ mA}$	$T_A = 25^\circ\text{C}$	585	750	$\mu\text{A}$
			$T_A = -40^\circ\text{C to }125^\circ\text{C}$		800	$\mu\text{A}$
<b>TEMPERATURE</b>						
	Specified range		-40		125	$^\circ\text{C}$
$T_A$	Operating range		-55		150	$^\circ\text{C}$
$T_{stg}$	Storage range		-65		150	$^\circ\text{C}$

### 7.10 Typical Characteristics

At  $T_A = 25^\circ\text{C}$ ,  $R_L = 10\text{ k}\Omega$  connected to  $V_S/2$ , and  $V_{OUT} = V_S/2$  (unless otherwise noted)

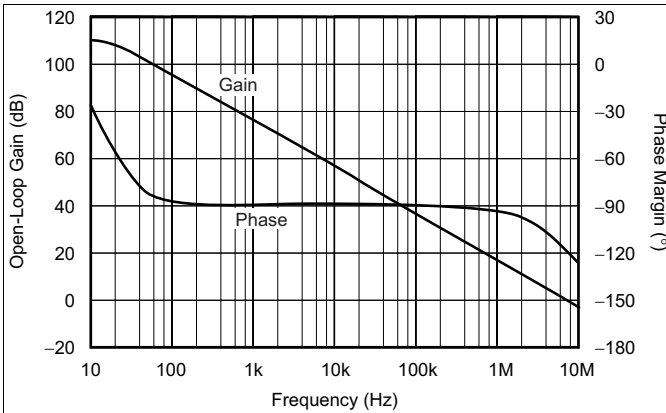

Figure 1. Open-Loop Gain and Phase vs Frequency

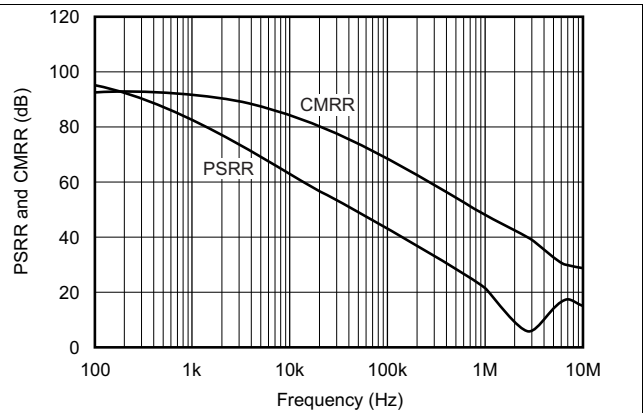

Figure 2. Power-Supply and Common-Mode Rejection Ratio vs Frequency

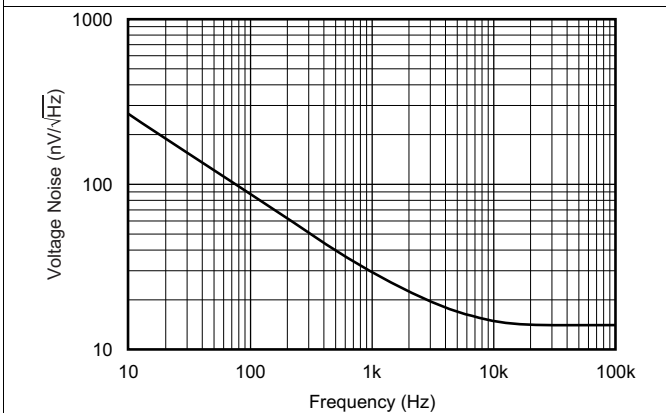

Figure 3. Input Voltage Noise Spectral Density vs Frequency

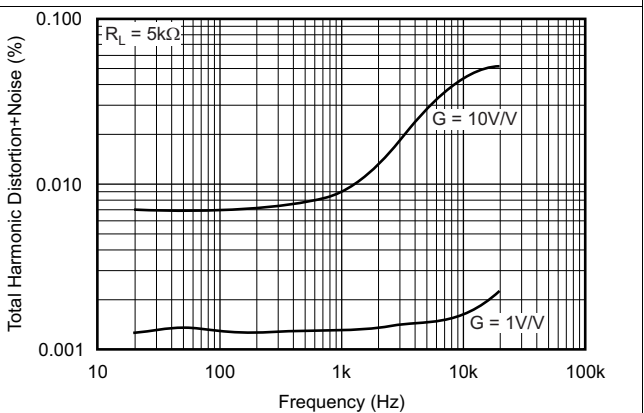

Figure 4. Total Harmonic Distortion + Noise vs Frequency

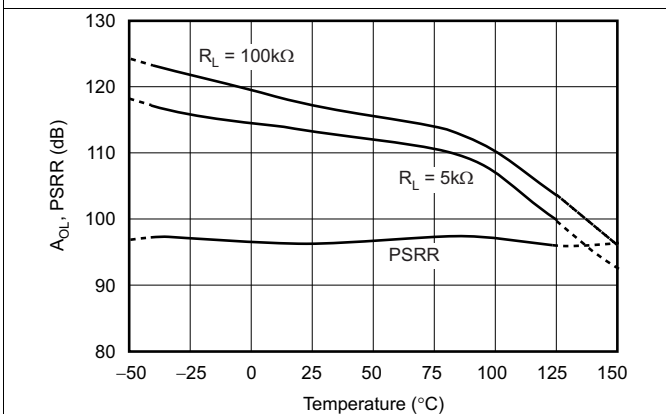

Figure 5. Open-Loop Gain and Power-Supply Rejection Ratio vs Temperature

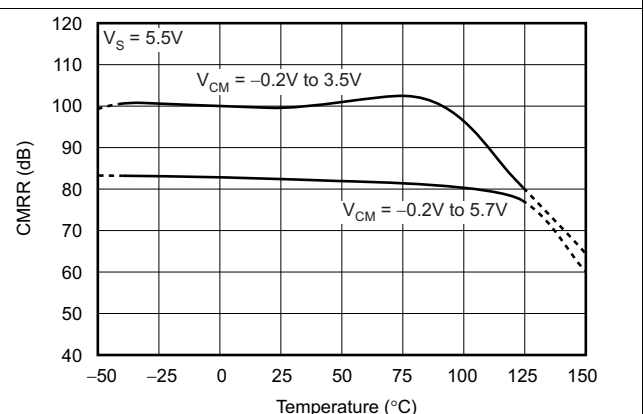

Figure 6. Common-Mode Rejection Ratio vs Temperature

## Typical Characteristics (continued)

At  $T_A = 25^\circ\text{C}$ ,  $R_L = 10\text{ k}\Omega$  connected to  $V_S/2$ , and  $V_{OUT} = V_S/2$  (unless otherwise noted)



Figure 7. Quiescent Current vs Temperature

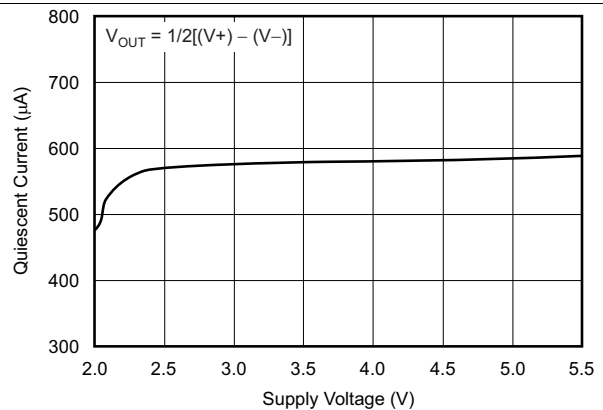

Figure 8. Quiescent Current vs Supply Voltage



Figure 9. Short-Circuit Current vs Temperature



Figure 10. Continuous Short-Circuit Current vs Power-Supply Voltage



Figure 11. Input Bias Current vs Temperature



Figure 12. Output Voltage Swing vs Output Current

### Typical Characteristics (continued)

At  $T_A = 25^\circ\text{C}$ ,  $R_L = 10\text{ k}\Omega$  connected to  $V_S/2$ , and  $V_{OUT} = V_S/2$  (unless otherwise noted)

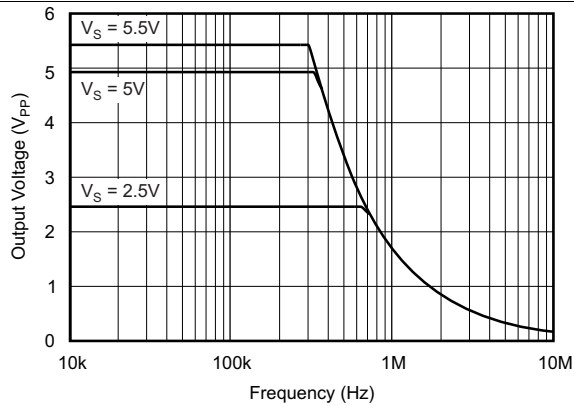

Figure 13. Maximum Output Voltage vs Frequency

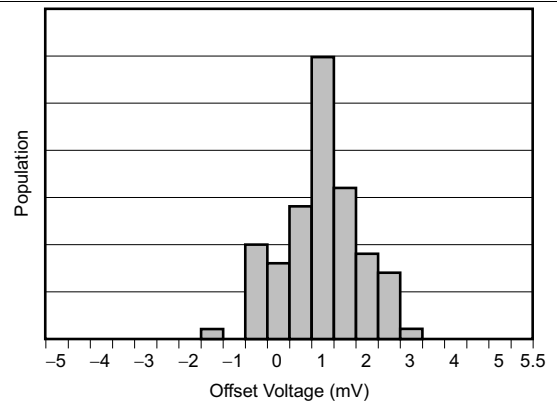

Figure 14. Offset Voltage Production Distribution



Figure 15. Offset Voltage Drift Magnitude Production Distribution



Figure 16. Small-Signal Step Response



Figure 17. Small-Signal Overshoot vs Load Capacitance



Figure 18. Large-Signal Step Response

## Typical Characteristics (continued)

At  $T_A = 25^\circ\text{C}$ ,  $R_L = 10\text{ k}\Omega$  connected to  $V_S/2$ , and  $V_{OUT} = V_S/2$  (unless otherwise noted)

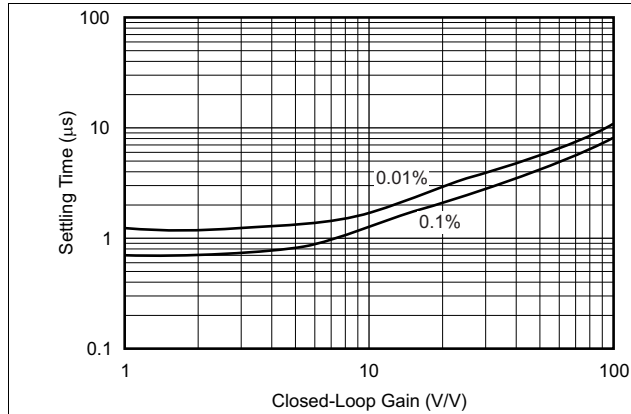

Figure 19. Settling Time vs Closed-Loop Gain

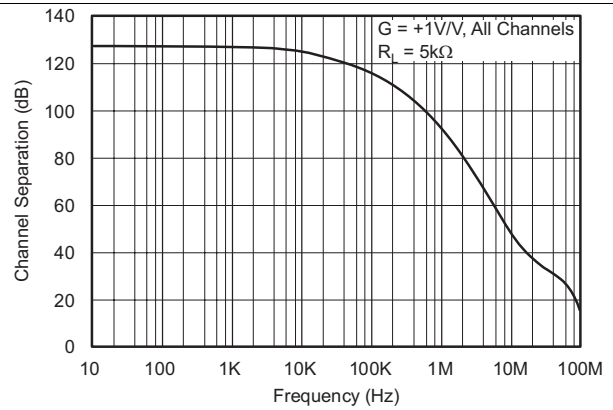

Figure 20. Channel Separation vs Frequency

## 8 Detailed Description

### 8.1 Overview

The OPAx373 and OPAx374 operational amplifiers (op amps) are suitable for a broad range of general-purpose applications. As unity-gain stable devices and outstanding AC performance, these op amps are ideal for audio applications. The class AB output stage is capable of driving 100-k $\Omega$  loads connected to any point between V+ and ground. These devices are well-suited for nearly any single-supply application up to a supply voltage of 5.5 V because the input common-mode voltage range includes both rails. Rail-to-rail input and output swing significantly increases the overall device dynamic range, especially in low-supply applications.

### 8.2 Functional Block Diagram



Copyright © 2016, Texas Instruments Incorporated

### 8.3 Feature Description

#### 8.3.1 Operating Voltage

The OPA373 and OPA374 op amps are specified and tested over a power-supply range of 2.7 V to 5.5 V ( $\pm 1.35$  V to  $\pm 2.75$  V). However, the supply voltage may range from 2.3 V to 5.5 V ( $\pm 1.15$  V to  $\pm 2.75$  V). Supply voltages higher than 7 V (absolute maximum) can permanently damage the amplifier. Parameters that vary over supply voltage or temperature are shown in the [Typical Characteristics](#).

## Feature Description (continued)

### 8.3.2 Common-Mode Voltage Range

The input common-mode voltage range of the OPA373 and OPA374 series extends 200 mV beyond the supply rails. This extended range is achieved with a complementary input stage: an N-channel input differential pair in parallel with a P-channel differential pair. The N-channel pair is active for input voltages close to the positive rail, typically  $(V+) - 1.65\text{ V}$  to 200 mV above the positive supply, while the P-channel pair is on for inputs from 200 mV below the negative supply to approximately  $(V+) - 1.65\text{ V}$ . There is a 500-mV transition region, typically  $(V+) - 1.9\text{ V}$  to  $(V+) - 1.4\text{ V}$ , in which both pairs are on. This 500-mV transition region, shown in Figure 21, can vary  $\pm 300\text{ mV}$  with process variation. Thus, the transition region (that is, both stages on) can range from  $(V+) - 2.2\text{ V}$  to  $(V+) - 1.7\text{ V}$  on the low end, up to  $(V+) - 1.6\text{ V}$  to  $(V+) - 1.1\text{ V}$  on the high end. Within the 500-mV transition region, PSRR, CMRR, offset voltage, offset drift, and THD may be degraded, compared to device operation outside this region.



Figure 21. Behavior of Typical Transition Region at Room Temperature

### 8.3.3 Rail-to-Rail Input

The input common-mode range extends from  $(V-) - 0.2\text{ V}$  to  $(V+) + 0.2\text{ V}$ . For normal operation, inputs must be limited to this range. The absolute maximum input voltage is 500 mV beyond the supplies. Inputs greater than the input common-mode range but less than the maximum input voltage, while not valid, do not cause any damage to the op amp. Unlike some other op amps, if input current is limited, the inputs may go beyond the supplies without phase inversion, as shown in Figure 22.



Figure 22. OPA373: No Phase Inversion With Inputs Greater Than the Power-Supply Voltage

Normally, input bias current is approximately 500 fA; however, input voltages exceeding the power supplies by more than 500 mV can cause excessive current to flow in or out of the input pins. Momentary voltages greater than 500 mV beyond the power supply can be tolerated if the current on the input pins is limited to 10 mA. This limiting is easily accomplished with an input resistor; see Figure 23. Many input signals are inherently current-limited to less than 10 mA, therefore, a limiting resistor is not required.

## Feature Description (continued)



Copyright © 2016, Texas Instruments Incorporated

**Figure 23. Input Current Protection for Voltages Exceeding the Supply Voltage**

### 8.3.4 Rail-to-Rail Output

A class AB output stage with common-source transistors is used to achieve rail-to-rail output. For light resistive loads ( $> 100\text{ k}\Omega$ ), the output voltage can typically swing to within 18 mV from the supply rails. With moderate resistive loads (5 k $\Omega$  to 50 k $\Omega$ ), the output can typically swing to within 100 mV from the supply rails and maintain high open-loop gain. See [Figure 12](#) for more information.

### 8.3.5 Capacitive Load and Stability

The OPA373 series op amps can drive a wide range of capacitive loads. However, under certain conditions, all op amps may become unstable. Op amp configuration, gain, and load value are some of the factors to consider when determining stability. An op amp in unity-gain configuration is the most susceptible to the effects of capacitive load. The capacitive load reacts with the op amp output resistance, along with any additional load resistance, to create a pole in the small-signal response that degrades the phase margin. The OPA373 series op amps perform well in unity-gain configuration, with a pure capacitive load up to approximately 250 pF. Increased gains allow the amplifier to drive more capacitance. See [Figure 17](#) for further details.

One method of improving capacitive load drive in the unity-gain configuration is to insert a small (10- $\Omega$  to 20- $\Omega$ ) resistor,  $R_S$ , in series with the output, as shown in [Figure 24](#). This configuration significantly reduces ringing while maintaining DC performance for purely capacitive loads. When there is a resistive load in parallel with the capacitive load,  $R_S$  must be placed within the feedback loop as shown to allow the feedback loop to compensate for the voltage divider created by  $R_S$  and  $R_L$ .



Copyright © 2016, Texas Instruments Incorporated

**Figure 24. Series Resistor in Unity-Gain Configuration Improves Capacitive Load Drive**

## Feature Description (continued)

In unity-gain inverter configuration, phase margin can be reduced by the reaction between the capacitance at the op amp input and the gain setting resistors, thus degrading capacitive load drive. Best performance is achieved by using small-valued resistors. However, when large-valued resistors cannot be avoided, a small (4-pF to 6-pF) capacitor,  $C_{FB}$ , can be inserted in the feedback, as shown in Figure 25. This technique significantly reduces overshoot by compensating the effect of capacitance,  $C_{IN}$ , which includes the amplifier input capacitance and printed-circuit board (PCB) parasitic capacitance.



Figure 25. Improving Capacitive Load Drive

For example, when driving a 100-pF load in unity-gain inverter configuration, adding a 6-pF capacitor in parallel with the 10-k $\Omega$  feedback resistor decreases overshoot from 57% to 12%, as shown in Figure 26.



Figure 26. Improving Capacitive Load Drive

### 8.3.6 Enable or Shutdown

The OPA373 and OPA374 series op amps typically require 585- $\mu$ A quiescent current. The enable or shutdown feature of the OPA373 allows the op amp to be shut off to reduce this current to less than 1  $\mu$ A.

## 8.4 Device Functional Modes

The OPAx374 has a single functional mode and is operational when the power-supply voltage is greater than 2.7 V ( $\pm$ 1.35 V). The maximum power supply voltage for the OPAx374 is 5.5 V ( $\pm$ 2.75 V).

The OPAx373 has two functional modes: active and shutdown. When the voltage at the Enable pin is from  $V-$  to  $(V-) + 0.8$  V, the device is in shutdown and consumes less than 0.5  $\mu$ A of quiescent current (typical). To activate, or enable, the device, the voltage at the Enable pin must be from  $(V-) + 2$  V to  $V+$ . When active, the power-supply requirements are the same as the OPAx374.

## 9 Application and Implementation

### NOTE

Information in the following applications sections is not part of the TI component specification, and TI does not warrant its accuracy or completeness. TI's customers are responsible for determining suitability of components for their purposes. Customers should validate and test their design implementation to confirm system functionality.

### 9.1 Application Information

The OPA373 and OPA374 series op amps are unity-gain stable and suitable for a wide range of general-purpose applications. Rail-to-rail input and output make them ideal for driving sampling analog-to-digital converters (ADCs). Excellent AC performance makes them well-suited for audio applications. The class AB output stage is capable of driving 100-k $\Omega$  loads connected to any point between V+ and ground.

The input common-mode voltage range includes both rails, allowing the OPA373 and OPA374 series op amps to be used in virtually any single-supply application up to a supply voltage of 5.5 V. Rail-to-rail input and output swing significantly increases dynamic range, especially in low-supply applications. Power-supply pins must be bypassed with 0.01- $\mu$ F ceramic capacitors.

### 9.2 Typical Application

This single-supply, low-side, bidirectional current-sensing solution detects load currents from  $-1$  A to  $1$  A. The single-ended output spans from 110 mV to 3.19 V. This design uses the OPA2374 because of its rail-to-rail input and output range and cost compared to performance. One of the amplifiers is configured as a difference amplifier, and the other amplifier provides the reference voltage.



Copyright © 2016, Texas Instruments Incorporated

Figure 27. Single-Supply, Low-Side, Bidirectional Current-Sensing Solution

#### 9.2.1 Design Requirements

This design has the following requirements:

- Supply voltage: 3.3 V
- Input:  $-1$  A to  $1$  A
- Output:  $1.65 \text{ V} \pm 1.54 \text{ V}$  (110 mV to 3.19 V)

## Typical Application (continued)

### 9.2.2 Detailed Design Procedure

The load current,  $I_{LOAD}$ , flows through the shunt resistor ( $R_{SHUNT}$ ) to develop the shunt voltage,  $V_{SHUNT}$ . The shunt voltage is then amplified by the difference amplifier, which consists of U1A and  $R_1$  through  $R_4$ . The gain of the difference amplifier is set by the ratio of  $R_4$  to  $R_3$ . To minimize errors, set  $R_2 = R_4$  and  $R_1 = R_3$ . The reference voltage,  $V_{REF}$ , is supplied by buffering a resistor divider using U1B. The transfer function is given by Equation 1.

$$V_{OUT} = V_{SHUNT} \times \text{Gain}_{\text{Diff\_Amp}} + V_{REF}$$

where

- $V_{SHUNT} = I_{LOAD} \times R_{SHUNT}$
- $\text{Gain}_{\text{Diff\_Amp}} = \frac{R_4}{R_3}$
- $V_{REF} = V_{CC} \times \left[ \frac{R_6}{R_5 + R_6} \right]$

(1)

There are two types of errors in this design: offset and gain. Gain errors are introduced by the tolerance of the shunt resistor and the ratios of  $R_4$  to  $R_3$  and, similarly,  $R_2$  to  $R_1$ . Offset errors are introduced by the voltage divider ( $R_5$  and  $R_6$ ) and how closely the ratio of  $R_4/R_3$  matches the ratio of  $R_2/R_1$ . The ratio of  $R_2/R_1$  impacts the CMRR of the difference amplifier, which ultimately translates to an offset error.

This is a low-side measurement. Therefore, the value of  $V_{SHUNT}$  is the ground potential for the system load. Thus, it is important to place a maximum value on  $V_{SHUNT}$ . In this design, the maximum value for  $V_{SHUNT}$  is set to 100 mV. Equation 2 calculates the maximum value of the shunt resistor given a maximum shunt voltage of 100 mV and maximum load current of 1 A.

$$R_{SHUNT\_Max} = \frac{|V_{SHUNT\_Max}|}{|I_{LOAD\_Max}|} = \frac{100 \text{ mV}}{1 \text{ A}} = 100 \text{ m}\Omega$$

(2)

The tolerance of  $R_{SHUNT}$  is directly proportional to cost. For this design, a shunt resistor with a tolerance of 0.5% was selected. If greater accuracy is required, select a 0.1% resistor or better.

Because the load current is bidirectional, the shunt voltage range is  $-100 \text{ mV}$  to  $100 \text{ mV}$ . This voltage is divided down by  $R_1$  and  $R_2$  before reaching the op amp, U1A. Take care to ensure that the voltage present at the noninverting node of U1A is within the common-mode range of the device.

It is therefore important to use an op amp, such as the OPA374, that has a common-mode range that extends below the negative supply voltage.

Given a symmetric load current of  $-1 \text{ A}$  to  $1 \text{ A}$ , the voltage divider resistors ( $R_5$  and  $R_6$ ) must be equal. To be consistent with the shunt resistor, a tolerance of 0.5% was selected. To minimize power consumption, 10-k $\Omega$  resistors were used.

To set the gain of the difference amplifier, the common-mode range and output swing of the OPA374 must be considered. Equation 3 and Equation 4 depict the typical common-mode range and output swing of the OPA374, given a 3.3-V supply.

$$-200 \text{ mV} < V_{CM} < 3.5 \text{ V}$$

(3)

$$100 \text{ mV} < V_{OUT} < 3.2 \text{ V}$$

(4)

The gain of the difference amplifier can now be calculated as shown in Equation 5.

$$\text{Gain}_{\text{Diff\_Amp}} = \frac{V_{OUT\_Max} - V_{OUT\_Min}}{R_{SHUNT} \times (I_{MAX} - I_{MIN})} = \frac{3.2 \text{ V} - 100 \text{ mV}}{100 \text{ m}\Omega \times [1 \text{ A} - (-1 \text{ A})]} = 15.5 \frac{\text{V}}{\text{V}}$$

(5)

The resistor value selected for  $R_1$  and  $R_3$  was 1 k $\Omega$ . 15.4 k $\Omega$  was selected for  $R_2$  and  $R_4$  because it is the nearest standard value. Therefore, the ideal gain of the difference amplifier is 15.4V/V.

Because the gain error of the circuit primarily depends on  $R_1$  through  $R_4$ , 0.1% resistors were selected. This value reduces the likelihood that the design requires a two-point calibration. A simple one-point calibration, if desired, removes the offset errors introduced by the 0.5% resistors.

## Typical Application (continued)

### 9.2.3 Application Curve

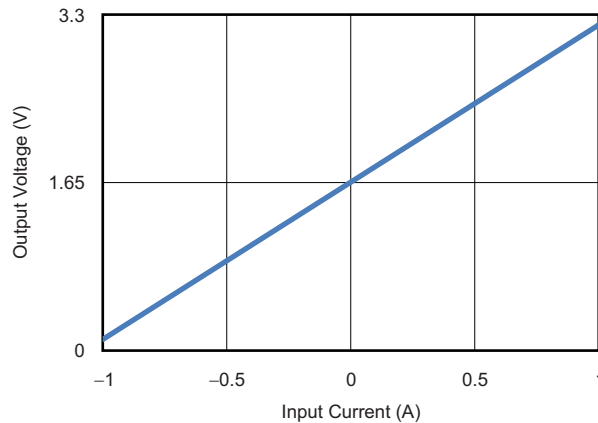

Figure 28. Output Voltage vs Input Current

## 9.3 System Examples

### 9.3.1 Driving ADCs

The OPA373 and OPA374 series op amps are optimized for driving medium-speed sampling ADCs. The OPA373 and OPA374 op amps buffer the ADC input capacitance and resulting charge injection, while providing signal gain.

The OPA373 is shown driving the ADS7816 in a basic noninverting configuration, as Figure 29 shows. The ADS7816 is a 12-bit, MicroPower sampling converter in the 8-pin VSSOP package. When used with the low-power, miniature packages of the OPA373, the combination is ideal for space-limited, low-power applications. In this configuration, an RC network at the ADC input can be used to provide anti-aliasing filtering.



Copyright © 2016, Texas Instruments Incorporated

Figure 29. The OPA373 in Noninverting Configuration Driving the ADS7816

## System Examples (continued)

Figure 30 shows the OPA373 driving the ADS7816 in a speech bypass-filtered data acquisition system. This small, low-cost solution provides the necessary amplification and signal conditioning to interface directly with an electret microphone. This circuit operates with  $V_S = 2.7\text{ V}$  to  $5\text{ V}$ .



Copyright © 2016, Texas Instruments Incorporated

**Figure 30. The OPA2373 as a Speech Bypass-Filtered Data Acquisition System**

The OPA373 is shown in the inverting configuration described in Figure 31. In this configuration, filtering may be accomplished with the capacitor across the feedback resistor.



$V_{IN} = 0\text{ V}$  to  $-5\text{ V}$  for  $0\text{ V}$  to  $5\text{ V}$  output.

NOTE: A/D Input =  $0$  to  $V_{REF}$

Copyright © 2016, Texas Instruments Incorporated

**Figure 31. The OPA373 in Inverting Configuration Driving the ADS7816**

Figure 32 shows the OPA373 configured as a three-pole, Sallen-Key, Butterworth low-pass filter.

## System Examples (continued)



Copyright © 2016, Texas Instruments Incorporated

Figure 32. Three-Pole, Sallen-Key, Butterworth Low-Pass Filter

## 10 Power Supply Recommendations

The OPAx373 and OPAx374 are specified for operation from 2.7 V to 5.5 V ( $\pm 1.35$  V to  $\pm 2.75$  V). Parameters that can exhibit significant variance with regard to operating voltage are presented in the [Typical Characteristics](#).

## 11 Layout

### 11.1 Layout Guidelines

The leadframe die pad must be soldered to a thermal pad on the PCB. A mechanical data sheet showing an example layout is attached at the end of this data sheet. Refinements to this layout may be required based on assembly process requirements.

Mechanical drawings located at the end of this data sheet list the physical dimensions for the package and pad. The five holes in the landing pattern are optional, and are intended for use with thermal vias that connect the leadframe die pad to the heat sink area on the PCB. Soldering the exposed pad significantly improves board-level reliability during temperature cycling, key push, package shear, and similar board-level tests.

Even with applications that have low-power dissipation, the exposed pad must be soldered to the PCB to provide structural integrity and long-term reliability.

#### 11.1.1 VSON Package

The OPA2373 is available in a 10-pin VSON package, which is a VQFN package with lead contacts on only two sides of the bottom of the package. This leadless, near-chip-scale package maximizes board space and enhances thermal and electrical characteristics through an exposed pad. VSON packages are physically small, have a smaller routing area, improved thermal performance, and improved electrical parasitics, with a pinout scheme that is consistent with other commonly-used packages, such as SOIC and VSSOP. Additionally, the absence of external leads eliminates bent-lead issues.

The VSON package can be easily mounted using standard PCP assembly techniques. See [QFN/SOP PCB Attachment](#) and [Quad Flatpack No-Lead Logic Packages](#), both available for download at [www.ti.com](http://www.ti.com).

#### NOTE

The exposed leadframe die pad on the bottom of the package must be connected to V-.

## 11.2 Layout Example



**Figure 33. Operational Amplifier Board Layout for Noninverting Configuration**

## 12 Device and Documentation Support

### 12.1 Device Support

#### 12.1.1 Development Support

##### 12.1.1.1 TINA-TI™ (Free Software Download)

TINA™ is a simple, powerful, and easy-to-use circuit simulation program based on a SPICE engine. TINA-TI™ is a free, fully-functional version of the TINA software, preloaded with a library of macro models in addition to a range of both passive and active models. TINA-TI provides all the conventional dc, transient, and frequency domain analysis of SPICE, as well as additional design capabilities.

Available as a [free download](#) from the Analog eLab Design Center, TINA-TI offers extensive post-processing capability that allows users to format results in a variety of ways. Virtual instruments offer the ability to select input waveforms and probe circuit nodes, voltages, and waveforms, creating a dynamic quick-start tool.

---

#### NOTE

These files require that either the TINA software (from DesignSoft™) or TINA-TI software be installed. Download the free TINA-TI software from the [TINA-TI folder](#).

---

##### 12.1.1.2 DIP Adapter EVM

The [DIP Adapter EVM](#) tool provides an easy, low-cost way to prototype small surface mount ICs. The evaluation tool these TI packages: D or U (8-pin SOIC), PW (8-pin TSSOP), DGK (8-pin MSOP), DBV (6-pin SOT-23, 5-pin SOT23, and 3-pin SOT-23), DCK (6-pin SC-70 and 5-pin SC-70), and DRL (6-pin SOT-563). The DIP Adapter EVM may also be used with terminal strips or may be wired directly to existing circuits.

##### 12.1.1.3 Universal Op Amp EVM

The [Universal Op Amp EVM](#) is a series of general-purpose, blank circuit boards that simplify prototyping circuits for a variety of IC package types. The evaluation module board design allows many different circuits to be constructed easily and quickly. Five models are offered, with each model intended for a specific package type. PDIP, SOIC, MSOP, TSSOP and SOT-23 packages are all supported.

---

#### NOTE

These boards are unpopulated, so users must provide their own ICs. TI recommends requesting several op amp device samples when ordering the Universal Op Amp EVM.

---

##### 12.1.1.4 TI Precision Designs

TI Precision Designs are analog solutions created by TI's precision analog applications experts and offer the theory of operation, component selection, simulation, complete PCB schematic and layout, bill of materials, and measured performance of many useful circuits. TI Precision Designs are available online at <http://www.ti.com/ww/en/analog/precision-designs/>.

##### 12.1.1.5 WEBENCH® Filter Designer

[WEBENCH® Filter Designer](#) is a simple, powerful, and easy-to-use active filter design program. The WEBENCH Filter Designer lets you create optimized filter designs using a selection of TI operational amplifiers and passive components from TI's vendor partners.

Available as a web-based tool from the WEBENCH® Design Center, [WEBENCH® Filter Designer](#) allows you to design, optimize, and simulate complete multistage active filter solutions within minutes.

## 12.2 Documentation Support

### 12.2.1 Related Documentation

The following documents are relevant to using the OPAx373, OPAx374, and recommended for reference. All are available for download at [www.ti.com](http://www.ti.com) (unless otherwise noted):

- [36-V, 1-kW Brushless DC Motor Drive With Stall Current Limit of < 1-μs Response Time Reference Design \(TIDU852\)](#)
- [OPA373 EMI Immunity Performance \(SBOZ009\)](#)
- [AB-045 Op Amp Performance Analysis \(SBOA054\)](#)
- [AB-067 Single-Supply Operation of Operational Amplifiers \(SBOA059\)](#)
- [AB-105 Tuning in Amplifiers \(SBOA067\)](#)
- [QFN/SON PCB Attachment \(SLUA271\)](#)
- [Quad Flatpack No-Lead Logic Packages \(SCBA017\)](#)

### 12.3 Related Links

**Table 1** lists quick access links. Categories include technical documents, support and community resources, tools and software, and quick access to sample or buy.

**Table 1. Related Links**

PARTS	PRODUCT FOLDER	SAMPLE & BUY	TECHNICAL DOCUMENTS	TOOLS & SOFTWARE	SUPPORT & COMMUNITY
OPA373	<a href="#">Click here</a>	<a href="#">Click here</a>	<a href="#">Click here</a>	<a href="#">Click here</a>	<a href="#">Click here</a>
OPA2373	<a href="#">Click here</a>	<a href="#">Click here</a>	<a href="#">Click here</a>	<a href="#">Click here</a>	<a href="#">Click here</a>
OPA374	<a href="#">Click here</a>	<a href="#">Click here</a>	<a href="#">Click here</a>	<a href="#">Click here</a>	<a href="#">Click here</a>
OPA2374	<a href="#">Click here</a>	<a href="#">Click here</a>	<a href="#">Click here</a>	<a href="#">Click here</a>	<a href="#">Click here</a>
OPA4374	<a href="#">Click here</a>	<a href="#">Click here</a>	<a href="#">Click here</a>	<a href="#">Click here</a>	<a href="#">Click here</a>

### 12.4 Receiving Notification of Documentation Updates

To receive notification of documentation updates, navigate to the device product folder on [ti.com](http://ti.com). In the upper right corner, click on *Alert me* to register and receive a weekly digest of any product information that has changed. For change details, review the revision history included in any revised document.

### 12.5 Community Resources

The following links connect to TI community resources. Linked contents are provided "AS IS" by the respective contributors. They do not constitute TI specifications and do not necessarily reflect TI's views; see TI's [Terms of Use](#).

**TI E2E™ Online Community** *TI's Engineer-to-Engineer (E2E) Community*. Created to foster collaboration among engineers. At [e2e.ti.com](http://e2e.ti.com), you can ask questions, share knowledge, explore ideas and help solve problems with fellow engineers.

**Design Support** *TI's Design Support* Quickly find helpful E2E forums along with design support tools and contact information for technical support.

### 12.6 Trademarks

TINA-TI, E2E are trademarks of Texas Instruments.  
 WEBENCH is a registered trademark of Texas Instruments.  
 TINA, DesignSoft are trademarks of DesignSoft, Inc.  
 All other trademarks are the property of their respective owners.

### 12.7 Electrostatic Discharge Caution



These devices have limited built-in ESD protection. The leads should be shorted together or the device placed in conductive foam during storage or handling to prevent electrostatic damage to the MOS gates.

## 12.8 Glossary

[SLYZ022](#) — *TI Glossary*.

This glossary lists and explains terms, acronyms, and definitions.

## 13 Mechanical, Packaging, and Orderable Information

The following pages include mechanical, packaging, and orderable information. This information is the most current data available for the designated devices. This data is subject to change without notice and revision of this document. For browser-based versions of this data sheet, refer to the left-hand navigation.

**PACKAGING INFORMATION**

Orderable Device	Status (1)	Package Type	Package Drawing	Pins	Package Qty	Eco Plan (2)	Lead/Ball Finish (6)	MSL Peak Temp (3)	Op Temp (°C)	Device Marking (4/5)	Samples
OPA2373AIDGSR	ACTIVE	VSSOP	DGS	10	2500	Green (RoHS & no Sb/Br)	CU NIPDAUAG	Level-2-260C-1 YEAR	-40 to 85	AYO	<a href="#">Samples</a>
OPA2373AIDGST	ACTIVE	VSSOP	DGS	10	250	Green (RoHS & no Sb/Br)	CU NIPDAUAG	Level-2-260C-1 YEAR	-40 to 85	AYO	<a href="#">Samples</a>
OPA2373AIDRCR	ACTIVE	VSON	DRC	10	3000	Green (RoHS & no Sb/Br)	CU NIPDAU	Level-2-260C-1 YEAR	-40 to 125	OCEQ	<a href="#">Samples</a>
OPA2373AIDRCT	ACTIVE	VSON	DRC	10	250	Green (RoHS & no Sb/Br)	CU NIPDAU	Level-2-260C-1 YEAR	-40 to 125	OCEQ	<a href="#">Samples</a>
OPA2374AID	ACTIVE	SOIC	D	8	75	Green (RoHS & no Sb/Br)	CU NIPDAU	Level-2-260C-1 YEAR	-40 to 125	OPA 2374A	<a href="#">Samples</a>
OPA2374AIDCNR	ACTIVE	SOT-23	DCN	8	3000	Green (RoHS & no Sb/Br)	CU NIPDAU	Level-2-260C-1 YEAR	-40 to 125	ATP	<a href="#">Samples</a>
OPA2374AIDCNRG4	ACTIVE	SOT-23	DCN	8	3000	Green (RoHS & no Sb/Br)	CU NIPDAU	Level-2-260C-1 YEAR	-40 to 125	ATP	<a href="#">Samples</a>
OPA2374AIDCNT	ACTIVE	SOT-23	DCN	8	250	Green (RoHS & no Sb/Br)	CU NIPDAU	Level-2-260C-1 YEAR	-40 to 125	ATP	<a href="#">Samples</a>
OPA2374AIDCNTG4	ACTIVE	SOT-23	DCN	8	250	Green (RoHS & no Sb/Br)	CU NIPDAU	Level-2-260C-1 YEAR	-40 to 125	ATP	<a href="#">Samples</a>
OPA2374AIDG4	ACTIVE	SOIC	D	8	75	Green (RoHS & no Sb/Br)	CU NIPDAU	Level-2-260C-1 YEAR	-40 to 125	OPA 2374A	<a href="#">Samples</a>
OPA2374AIDR	ACTIVE	SOIC	D	8	2500	Green (RoHS & no Sb/Br)	CU NIPDAU	Level-2-260C-1 YEAR		OPA 2374A	<a href="#">Samples</a>
OPA373AID	ACTIVE	SOIC	D	8	75	Green (RoHS & no Sb/Br)	CU NIPDAU	Level-2-260C-1 YEAR	-40 to 125	OPA 373A	<a href="#">Samples</a>
OPA373AIDBVR	ACTIVE	SOT-23	DBV	6	3000	Green (RoHS & no Sb/Br)	CU NIPDAU	Level-2-260C-1 YEAR	-40 to 125	A75	<a href="#">Samples</a>
OPA373AIDBVRG4	ACTIVE	SOT-23	DBV	6	3000	Green (RoHS & no Sb/Br)	CU NIPDAU	Level-2-260C-1 YEAR	-40 to 125	A75	<a href="#">Samples</a>
OPA373AIDBVT	ACTIVE	SOT-23	DBV	6	250	Green (RoHS & no Sb/Br)	CU NIPDAU	Level-2-260C-1 YEAR	-40 to 125	A75	<a href="#">Samples</a>
OPA373AIDBVTG4	ACTIVE	SOT-23	DBV	6	250	Green (RoHS & no Sb/Br)	CU NIPDAU	Level-2-260C-1 YEAR	-40 to 125	A75	<a href="#">Samples</a>
OPA373AIDR	ACTIVE	SOIC	D	8	2500	Green (RoHS & no Sb/Br)	CU NIPDAU	Level-2-260C-1 YEAR	-40 to 125	OPA 373A	<a href="#">Samples</a>

Orderable Device	Status (1)	Package Type	Package Drawing	Pins	Package Qty	Eco Plan (2)	Lead/Ball Finish (6)	MSL Peak Temp (3)	Op Temp (°C)	Device Marking (4/5)	Samples
OPA373AIDRG4	ACTIVE	SOIC	D	8	2500	Green (RoHS & no Sb/Br)	CU NIPDAU	Level-2-260C-1 YEAR	-40 to 125	OPA 373A	<a href="#">Samples</a>
OPA374AID	ACTIVE	SOIC	D	8	75	Green (RoHS & no Sb/Br)	CU NIPDAU	Level-2-260C-1 YEAR	-40 to 125	OPA 374A	<a href="#">Samples</a>
OPA374AIDBVR	ACTIVE	SOT-23	DBV	5	3000	Green (RoHS & no Sb/Br)	CU NIPDAU	Level-2-260C-1 YEAR	-40 to 125	A76	<a href="#">Samples</a>
OPA374AIDBVRG4	ACTIVE	SOT-23	DBV	5	3000	Green (RoHS & no Sb/Br)	CU NIPDAU	Level-2-260C-1 YEAR	-40 to 125	A76	<a href="#">Samples</a>
OPA374AIDBVT	ACTIVE	SOT-23	DBV	5	250	Green (RoHS & no Sb/Br)	CU NIPDAU	Level-2-260C-1 YEAR	-40 to 125	A76	<a href="#">Samples</a>
OPA374AIDBVTG4	ACTIVE	SOT-23	DBV	5	250	Green (RoHS & no Sb/Br)	CU NIPDAU	Level-2-260C-1 YEAR	-40 to 125	A76	<a href="#">Samples</a>
OPA374AIDR	ACTIVE	SOIC	D	8	2500	Green (RoHS & no Sb/Br)	CU NIPDAU	Level-2-260C-1 YEAR	-40 to 125	OPA 374A	<a href="#">Samples</a>
OPA374AIDRG4	ACTIVE	SOIC	D	8	2500	Green (RoHS & no Sb/Br)	CU NIPDAU	Level-2-260C-1 YEAR	-40 to 125	OPA 374A	<a href="#">Samples</a>
OPA4374AID	ACTIVE	SOIC	D	14	50	Green (RoHS & no Sb/Br)	CU NIPDAU	Level-2-260C-1 YEAR	-40 to 125	OPA4374A	<a href="#">Samples</a>
OPA4374AIDR	ACTIVE	SOIC	D	14	2500	Green (RoHS & no Sb/Br)	CU NIPDAU	Level-2-260C-1 YEAR	-40 to 125	OPA4374A	<a href="#">Samples</a>
OPA4374AIDRG4	ACTIVE	SOIC	D	14	2500	Green (RoHS & no Sb/Br)	CU NIPDAU	Level-2-260C-1 YEAR	-40 to 125	OPA4374A	<a href="#">Samples</a>
OPA4374AIPWR	ACTIVE	TSSOP	PW	14	2500	Green (RoHS & no Sb/Br)	CU NIPDAU	Level-2-260C-1 YEAR	-40 to 125	OPA 4374A	<a href="#">Samples</a>
OPA4374AIPWRG4	ACTIVE	TSSOP	PW	14	2500	Green (RoHS & no Sb/Br)	CU NIPDAU	Level-2-260C-1 YEAR	-40 to 125	OPA 4374A	<a href="#">Samples</a>
OPA4374AIPWT	ACTIVE	TSSOP	PW	14	250	Green (RoHS & no Sb/Br)	CU NIPDAU	Level-2-260C-1 YEAR	-40 to 125	OPA 4374A	<a href="#">Samples</a>

(1) The marketing status values are defined as follows:

**ACTIVE:** Product device recommended for new designs.

**LIFEBUY:** TI has announced that the device will be discontinued, and a lifetime-buy period is in effect.

**NRND:** Not recommended for new designs. Device is in production to support existing customers, but TI does not recommend using this part in a new design.

**PREVIEW:** Device has been announced but is not in production. Samples may or may not be available.

**OBsolete:** TI has discontinued the production of the device.

(2) **RoHS:** TI defines "RoHS" to mean semiconductor products that are compliant with the current EU RoHS requirements for all 10 RoHS substances, including the requirement that RoHS substance do not exceed 0.1% by weight in homogeneous materials. Where designed to be soldered at high temperatures, "RoHS" products are suitable for use in specified lead-free processes. TI may reference these types of products as "Pb-Free".

**RoHS Exempt:** TI defines "RoHS Exempt" to mean products that contain lead but are compliant with EU RoHS pursuant to a specific EU RoHS exemption.

**Green:** TI defines "Green" to mean the content of Chlorine (Cl) and Bromine (Br) based flame retardants meet JS709B low halogen requirements of  $\leq 1000$ ppm threshold. Antimony trioxide based flame retardants must also meet the  $\leq 1000$ ppm threshold requirement.

(3) MSL, Peak Temp. - The Moisture Sensitivity Level rating according to the JEDEC industry standard classifications, and peak solder temperature.

(4) There may be additional marking, which relates to the logo, the lot trace code information, or the environmental category on the device.

(5) Multiple Device Markings will be inside parentheses. Only one Device Marking contained in parentheses and separated by a "~" will appear on a device. If a line is indented then it is a continuation of the previous line and the two combined represent the entire Device Marking for that device.

(6) Lead/Ball Finish - Orderable Devices may have multiple material finish options. Finish options are separated by a vertical ruled line. Lead/Ball Finish values may wrap to two lines if the finish value exceeds the maximum column width.

**Important Information and Disclaimer:** The information provided on this page represents TI's knowledge and belief as of the date that it is provided. TI bases its knowledge and belief on information provided by third parties, and makes no representation or warranty as to the accuracy of such information. Efforts are underway to better integrate information from third parties. TI has taken and continues to take reasonable steps to provide representative and accurate information but may not have conducted destructive testing or chemical analysis on incoming materials and chemicals. TI and TI suppliers consider certain information to be proprietary, and thus CAS numbers and other limited information may not be available for release.

In no event shall TI's liability arising out of such information exceed the total purchase price of the TI part(s) at issue in this document sold by TI to Customer on an annual basis.

**TAPE AND REEL INFORMATION**

**QUADRANT ASSIGNMENTS FOR PIN 1 ORIENTATION IN TAPE**

\*All dimensions are nominal

Device	Package Type	Package Drawing	Pins	SPQ	Reel Diameter (mm)	Reel Width W1 (mm)	A0 (mm)	B0 (mm)	K0 (mm)	P1 (mm)	W (mm)	Pin1 Quadrant
OPA2373AIDGSR	VSSOP	DGS	10	2500	330.0	12.4	5.3	3.4	1.4	8.0	12.0	Q1
OPA2373AIDGST	VSSOP	DGS	10	250	180.0	12.4	5.3	3.4	1.4	8.0	12.0	Q1
OPA2373AIDRCR	VSON	DRC	10	3000	330.0	12.4	3.3	3.3	1.1	8.0	12.0	Q2
OPA2373AIDRCT	VSON	DRC	10	250	180.0	12.4	3.3	3.3	1.1	8.0	12.0	Q2
OPA2374AIDR	SOIC	D	8	2500	330.0	12.4	6.4	5.2	2.1	8.0	12.0	Q1
OPA373AIDBVR	SOT-23	DBV	6	3000	178.0	9.0	3.3	3.2	1.4	4.0	8.0	Q3
OPA373AIDBVT	SOT-23	DBV	6	250	178.0	9.0	3.3	3.2	1.4	4.0	8.0	Q3
OPA373AIDR	SOIC	D	8	2500	330.0	12.4	6.4	5.2	2.1	8.0	12.0	Q1
OPA374AIDBVR	SOT-23	DBV	5	3000	178.0	8.4	3.3	3.2	1.4	4.0	8.0	Q3
OPA374AIDBVT	SOT-23	DBV	5	250	178.0	8.4	3.3	3.2	1.4	4.0	8.0	Q3
OPA374AIDR	SOIC	D	8	2500	330.0	12.4	6.4	5.2	2.1	8.0	12.0	Q1
OPA4374AIDR	SOIC	D	14	2500	330.0	16.4	6.5	9.0	2.1	8.0	16.0	Q1
OPA4374AIPWR	TSSOP	PW	14	2500	330.0	12.4	6.9	5.6	1.6	8.0	12.0	Q1
OPA4374AIPWT	TSSOP	PW	14	250	180.0	12.4	6.9	5.6	1.6	8.0	12.0	Q1

**TAPE AND REEL BOX DIMENSIONS**

\*All dimensions are nominal

Device	Package Type	Package Drawing	Pins	SPQ	Length (mm)	Width (mm)	Height (mm)
OPA2373AIDGSR	VSSOP	DGS	10	2500	367.0	367.0	35.0
OPA2373AIDGST	VSSOP	DGS	10	250	210.0	185.0	35.0
OPA2373AIDRCR	VSON	DRC	10	3000	367.0	367.0	35.0
OPA2373AIDRCT	VSON	DRC	10	250	210.0	185.0	35.0
OPA2374AIDR	SOIC	D	8	2500	367.0	367.0	35.0
OPA373AIDBVR	SOT-23	DBV	6	3000	445.0	220.0	345.0
OPA373AIDBVT	SOT-23	DBV	6	250	445.0	220.0	345.0
OPA373AIDR	SOIC	D	8	2500	367.0	367.0	35.0
OPA374AIDBVR	SOT-23	DBV	5	3000	565.0	140.0	75.0
OPA374AIDBVT	SOT-23	DBV	5	250	565.0	140.0	75.0
OPA374AIDR	SOIC	D	8	2500	367.0	367.0	35.0
OPA4374AIDR	SOIC	D	14	2500	367.0	367.0	38.0
OPA4374AIPWR	TSSOP	PW	14	2500	367.0	367.0	35.0
OPA4374AIPWT	TSSOP	PW	14	250	210.0	185.0	35.0

DBV0006A



# PACKAGE OUTLINE

SOT-23 - 1.45 mm max height

SMALL OUTLINE TRANSISTOR

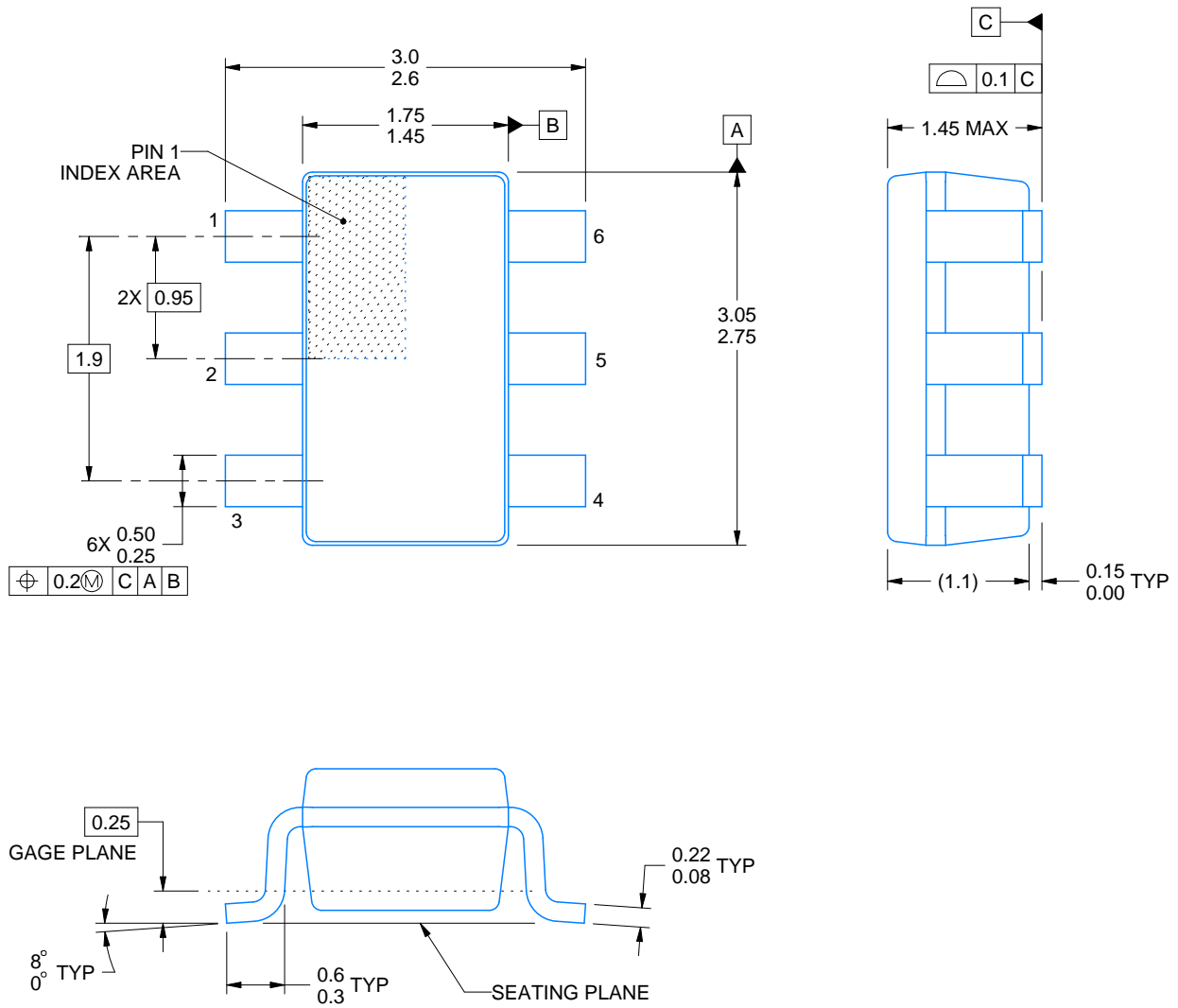

4214840/B 03/2018

## NOTES:

1. All linear dimensions are in millimeters. Any dimensions in parenthesis are for reference only. Dimensioning and tolerancing per ASME Y14.5M.
2. This drawing is subject to change without notice.
3. Body dimensions do not include mold flash or protrusion. Mold flash and protrusion shall not exceed 0.15 per side.
4. Leads 1,2,3 may be wider than leads 4,5,6 for package orientation.
5. Reference JEDEC MO-178.

# EXAMPLE BOARD LAYOUT

DBV0006A

SOT-23 - 1.45 mm max height

SMALL OUTLINE TRANSISTOR



LAND PATTERN EXAMPLE  
EXPOSED METAL SHOWN  
SCALE:15X



SOLDER MASK DETAILS

4214840/B 03/2018

NOTES: (continued)

6. Publication IPC-7351 may have alternate designs.

7. Solder mask tolerances between and around signal pads can vary based on board fabrication site.

# EXAMPLE STENCIL DESIGN

DBV0006A

SOT-23 - 1.45 mm max height

SMALL OUTLINE TRANSISTOR

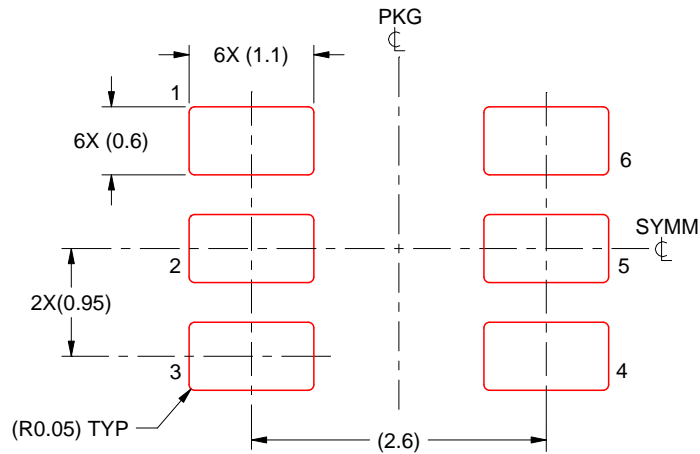

SOLDER PASTE EXAMPLE  
BASED ON 0.125 mm THICK STENCIL  
SCALE:15X

4214840/B 03/2018

NOTES: (continued)

8. Laser cutting apertures with trapezoidal walls and rounded corners may offer better paste release. IPC-7525 may have alternate design recommendations.
9. Board assembly site may have different recommendations for stencil design.

DCN (R-PDSO-G8)

PLASTIC SMALL-OUTLINE PACKAGE (DIE DOWN)

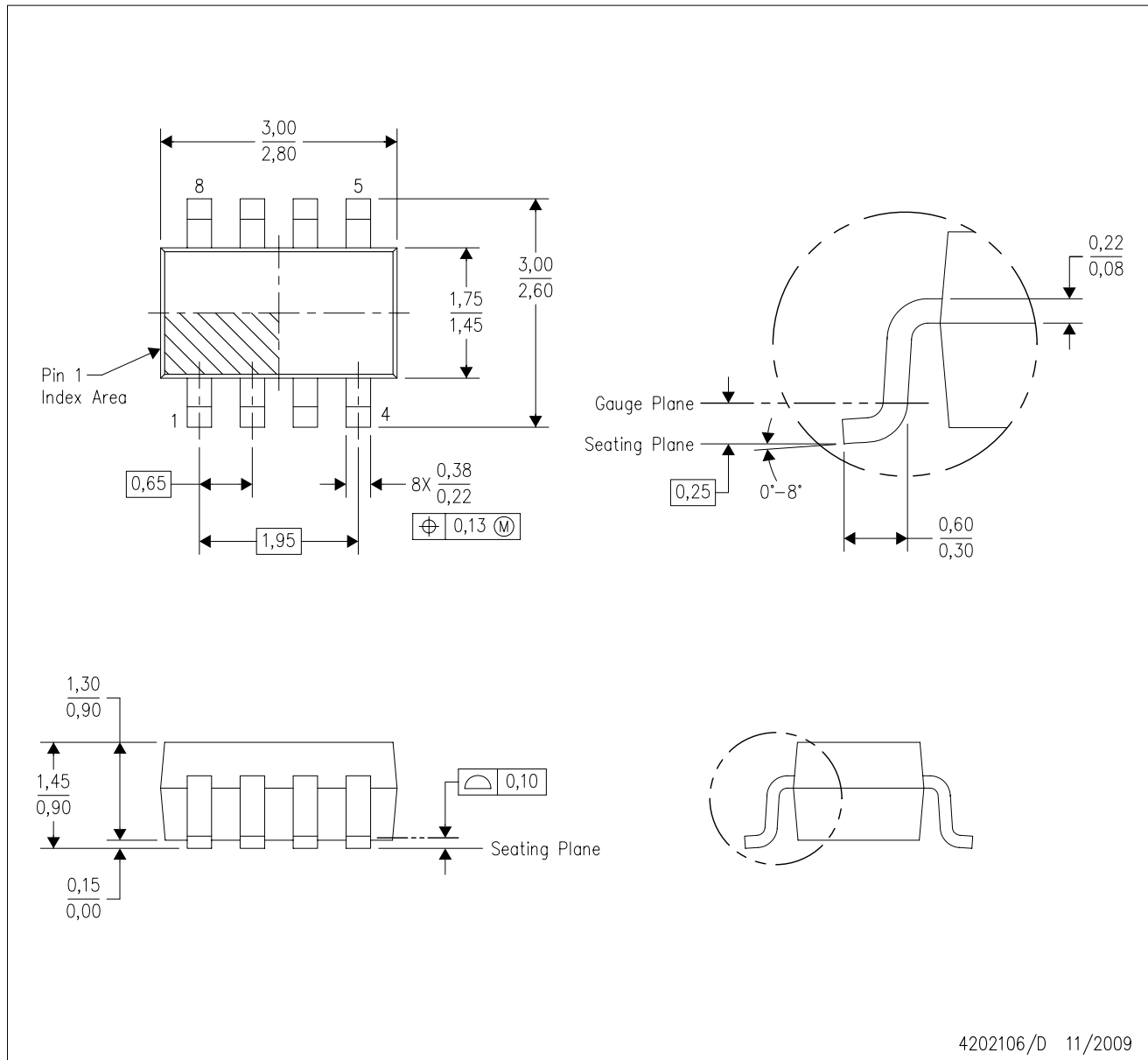

- NOTES:
- A. All linear dimensions are in millimeters.
  - B. This drawing is subject to change without notice.
  - C. Package outline exclusive of metal burr & dambar protrusion/intrusion.
  - D. Package outline inclusive of solder plating.
  - E. A visual index feature must be located within the Pin 1 index area.
  - F. Falls within JEDEC MO-178 Variation BA.
  - G. Body dimensions do not include flash or protrusion. Mold flash and protrusion shall not exceed 0.25 per side.

DCN (R-PDSO-G8)

PLASTIC SMALL-OUTLINE PACKAGE (DIE DOWN)



- NOTES:
- A. All linear dimensions are in millimeters.
  - B. This drawing is subject to change without notice.
  - C. Publication IPC-7351 is recommended for alternate designs.
  - D. Laser cutting apertures with trapezoidal walls and also rounding corners will offer better paste release. Customers should contact their board assembly site for stencil design recommendations. Refer to IPC-7525.
  - E. Customers should contact their board fabrication site for solder mask tolerances between and around signal pads.

# DGS0010A



# PACKAGE OUTLINE

## VSSOP - 1.1 mm max height

SMALL OUTLINE PACKAGE



4221984/A 05/2015

### NOTES:

1. All linear dimensions are in millimeters. Any dimensions in parenthesis are for reference only. Dimensioning and tolerancing per ASME Y14.5M.
2. This drawing is subject to change without notice.
3. This dimension does not include mold flash, protrusions, or gate burrs. Mold flash, protrusions, or gate burrs shall not exceed 0.15 mm per side.
4. This dimension does not include interlead flash. Interlead flash shall not exceed 0.25 mm per side.
5. Reference JEDEC registration MO-187, variation BA.

# EXAMPLE BOARD LAYOUT

DGS0010A

VSSOP - 1.1 mm max height

SMALL OUTLINE PACKAGE



LAND PATTERN EXAMPLE  
SCALE:10X



SOLDER MASK DETAILS  
NOT TO SCALE

4221984/A 05/2015

NOTES: (continued)

- 6. Publication IPC-7351 may have alternate designs.
- 7. Solder mask tolerances between and around signal pads can vary based on board fabrication site.

# EXAMPLE STENCIL DESIGN

DGS0010A

VSSOP - 1.1 mm max height

SMALL OUTLINE PACKAGE



SOLDER PASTE EXAMPLE  
BASED ON 0.125 mm THICK STENCIL  
SCALE:10X

4221984/A 05/2015

NOTES: (continued)

8. Laser cutting apertures with trapezoidal walls and rounded corners may offer better paste release. IPC-7525 may have alternate design recommendations.
9. Board assembly site may have different recommendations for stencil design.



D (R-PDSO-G14)

PLASTIC SMALL OUTLINE

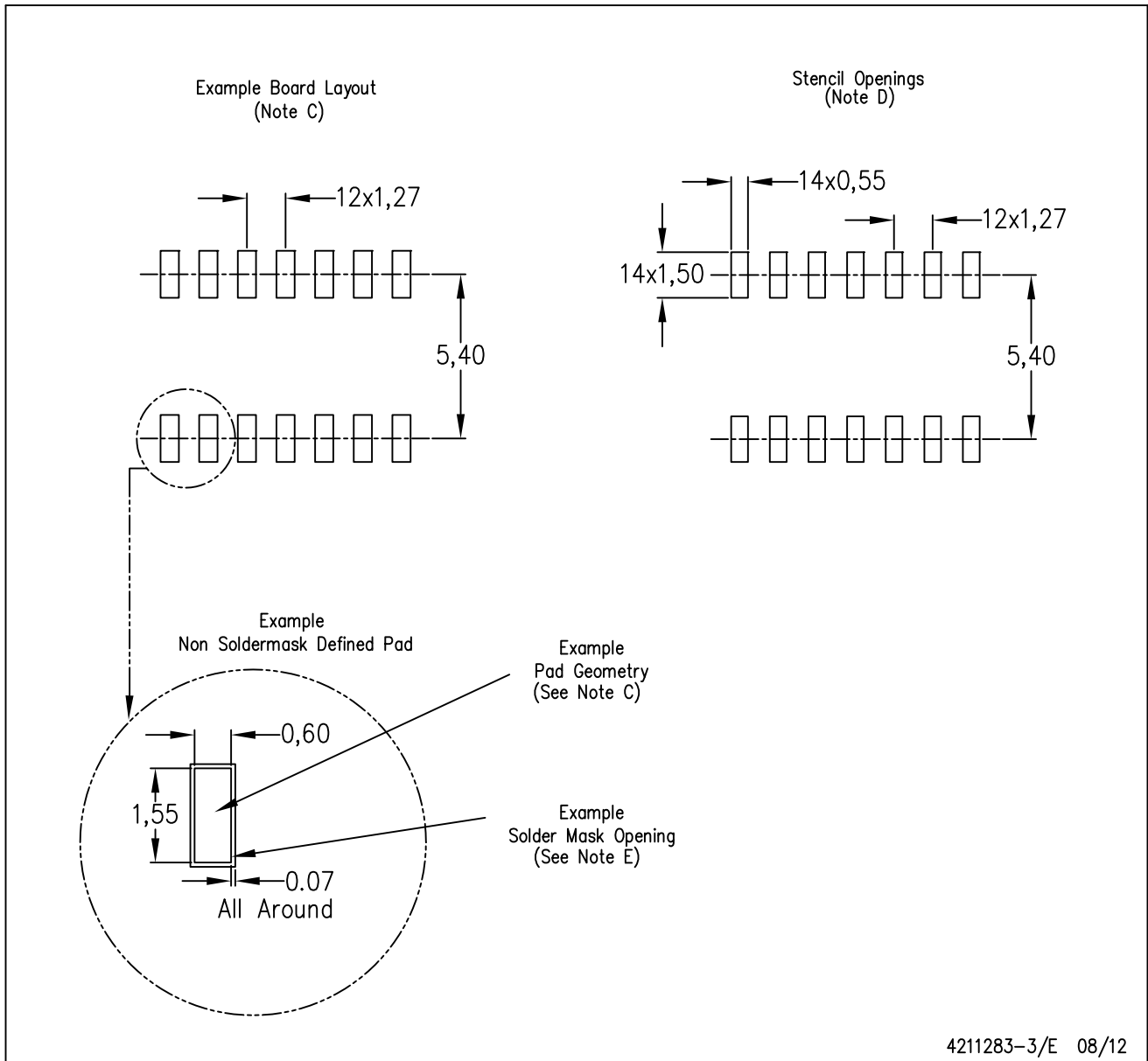

- NOTES:
- All linear dimensions are in millimeters.
  - This drawing is subject to change without notice.
  - Publication IPC-7351 is recommended for alternate designs.
  - Laser cutting apertures with trapezoidal walls and also rounding corners will offer better paste release. Customers should contact their board assembly site for stencil design recommendations. Refer to IPC-7525 for other stencil recommendations.
  - Customers should contact their board fabrication site for solder mask tolerances between and around signal pads.



PW (R-PDSO-G14)

PLASTIC SMALL OUTLINE



- NOTES:
- All linear dimensions are in millimeters.
  - This drawing is subject to change without notice.
  - Publication IPC-7351 is recommended for alternate designs.
  - Laser cutting apertures with trapezoidal walls and also rounding corners will offer better paste release. Customers should contact their board assembly site for stencil design recommendations. Refer to IPC-7525 for other stencil recommendations.
  - Customers should contact their board fabrication site for solder mask tolerances between and around signal pads.



D0008A

# PACKAGE OUTLINE

SOIC - 1.75 mm max height

SMALL OUTLINE INTEGRATED CIRCUIT



4214825/C 02/2019

### NOTES:

- Linear dimensions are in inches [millimeters]. Dimensions in parenthesis are for reference only. Controlling dimensions are in inches. Dimensioning and tolerancing per ASME Y14.5M.
- This drawing is subject to change without notice.
- This dimension does not include mold flash, protrusions, or gate burrs. Mold flash, protrusions, or gate burrs shall not exceed  $.006$  [0.15] per side.
- This dimension does not include interlead flash.
- Reference JEDEC registration MS-012, variation AA.

# EXAMPLE BOARD LAYOUT

D0008A

SOIC - 1.75 mm max height

SMALL OUTLINE INTEGRATED CIRCUIT



LAND PATTERN EXAMPLE  
 EXPOSED METAL SHOWN  
 SCALE:8X



SOLDER MASK DETAILS

4214825/C 02/2019

NOTES: (continued)

- 6. Publication IPC-7351 may have alternate designs.
- 7. Solder mask tolerances between and around signal pads can vary based on board fabrication site.

# EXAMPLE STENCIL DESIGN

D0008A

SOIC - 1.75 mm max height

SMALL OUTLINE INTEGRATED CIRCUIT



SOLDER PASTE EXAMPLE  
BASED ON .005 INCH [0.125 MM] THICK STENCIL  
SCALE:8X

4214825/C 02/2019

NOTES: (continued)

8. Laser cutting apertures with trapezoidal walls and rounded corners may offer better paste release. IPC-7525 may have alternate design recommendations.
9. Board assembly site may have different recommendations for stencil design.

DBV0005A



# PACKAGE OUTLINE

SOT-23 - 1.45 mm max height

SMALL OUTLINE TRANSISTOR

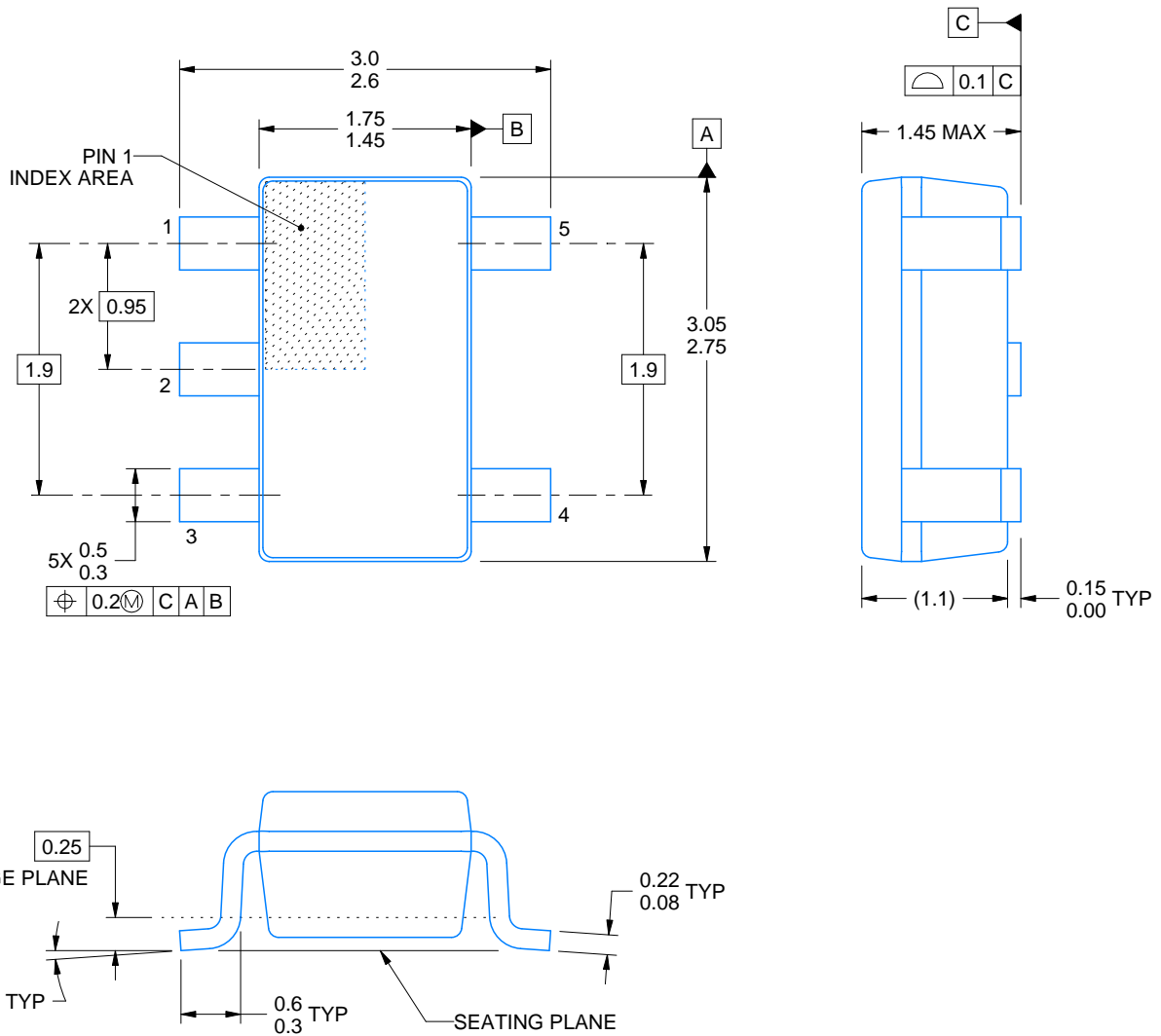

4214839/D 11/2018

NOTES:

1. All linear dimensions are in millimeters. Any dimensions in parenthesis are for reference only. Dimensioning and tolerancing per ASME Y14.5M.
2. This drawing is subject to change without notice.
3. Reference JEDEC MO-178.
4. Body dimensions do not include mold flash, protrusions, or gate burrs. Mold flash, protrusions, or gate burrs shall not exceed 0.15 mm per side.

# EXAMPLE BOARD LAYOUT

DBV0005A

SOT-23 - 1.45 mm max height

SMALL OUTLINE TRANSISTOR



LAND PATTERN EXAMPLE  
EXPOSED METAL SHOWN  
SCALE:15X

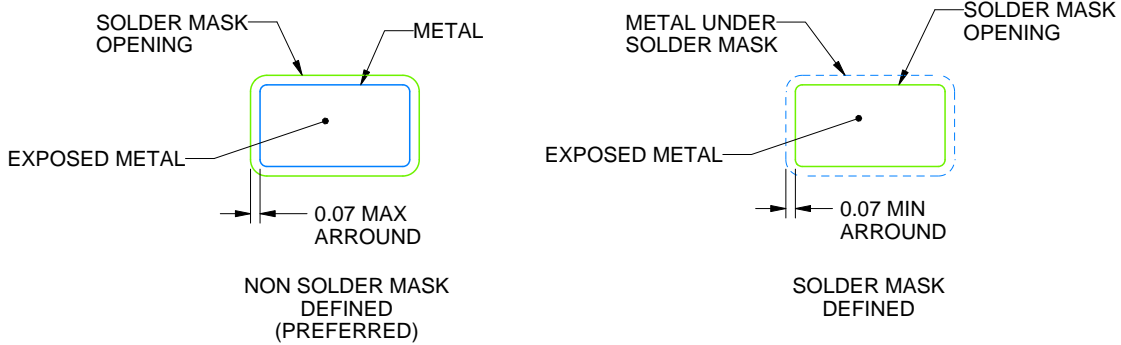

SOLDER MASK DETAILS

4214839/D 11/2018

NOTES: (continued)

- Publication IPC-7351 may have alternate designs.
- Solder mask tolerances between and around signal pads can vary based on board fabrication site.

# EXAMPLE STENCIL DESIGN

DBV0005A

SOT-23 - 1.45 mm max height

SMALL OUTLINE TRANSISTOR



SOLDER PASTE EXAMPLE  
BASED ON 0.125 mm THICK STENCIL  
SCALE:15X

4214839/D 11/2018

NOTES: (continued)

7. Laser cutting apertures with trapezoidal walls and rounded corners may offer better paste release. IPC-7525 may have alternate design recommendations.
8. Board assembly site may have different recommendations for stencil design.

## GENERIC PACKAGE VIEW

DRC 10

VSON - 1 mm max height

PLASTIC SMALL OUTLINE - NO LEAD



Images above are just a representation of the package family, actual package may vary.  
Refer to the product data sheet for package details.

4204102-3/M



# EXAMPLE BOARD LAYOUT

DRC0010J

VSON - 1 mm max height

PLASTIC SMALL OUTLINE - NO LEAD



LAND PATTERN EXAMPLE  
EXPOSED METAL SHOWN  
SCALE:20X



SOLDER MASK DETAILS

4218878/B 07/2018

NOTES: (continued)

4. This package is designed to be soldered to a thermal pad on the board. For more information, see Texas Instruments literature number SLUA271 ([www.ti.com/lit/sluea271](http://www.ti.com/lit/sluea271)).
5. Vias are optional depending on application, refer to device data sheet. If any vias are implemented, refer to their locations shown on this view. It is recommended that vias under paste be filled, plugged or tented.

# EXAMPLE STENCIL DESIGN

DRC0010J

VSON - 1 mm max height

PLASTIC SMALL OUTLINE - NO LEAD

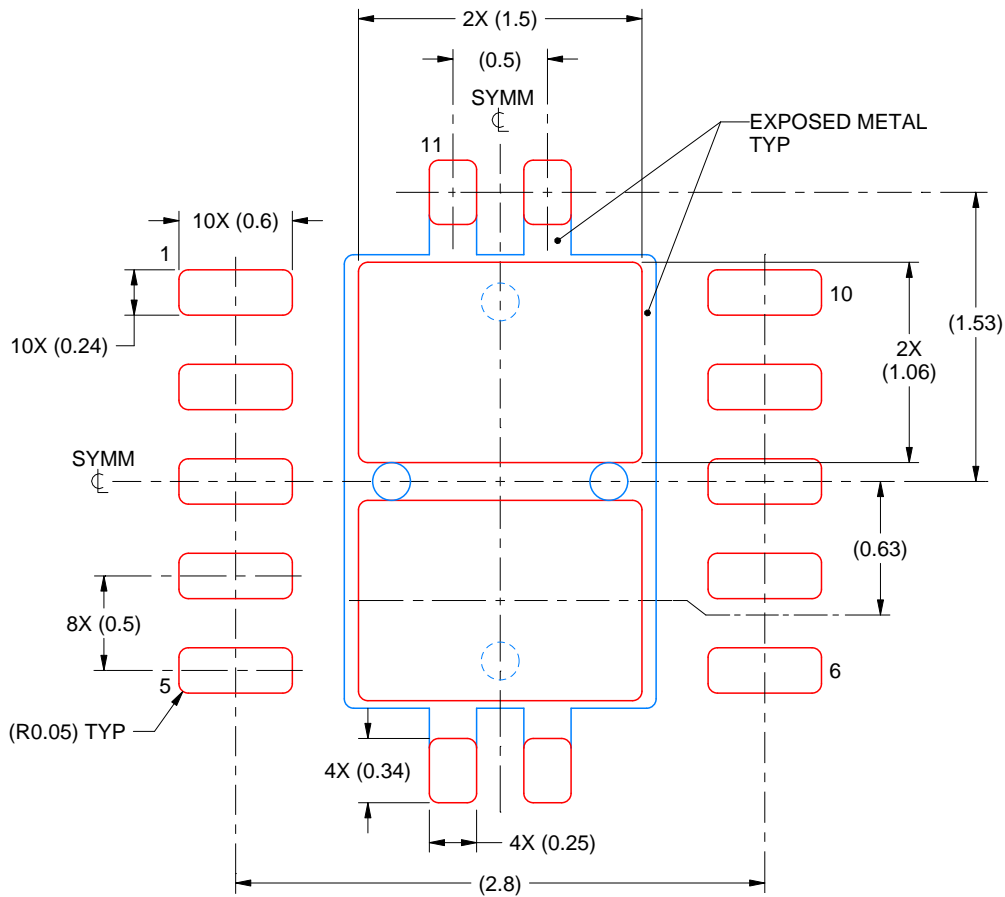

SOLDER PASTE EXAMPLE  
BASED ON 0.125 mm THICK STENCIL

EXPOSED PAD 11:  
80% PRINTED SOLDER COVERAGE BY AREA  
SCALE:25X

4218878/B 07/2018

NOTES: (continued)

6. Laser cutting apertures with trapezoidal walls and rounded corners may offer better paste release. IPC-7525 may have alternate design recommendations.

## IMPORTANT NOTICE AND DISCLAIMER

TI PROVIDES TECHNICAL AND RELIABILITY DATA (INCLUDING DATASHEETS), DESIGN RESOURCES (INCLUDING REFERENCE DESIGNS), APPLICATION OR OTHER DESIGN ADVICE, WEB TOOLS, SAFETY INFORMATION, AND OTHER RESOURCES "AS IS" AND WITH ALL FAULTS, AND DISCLAIMS ALL WARRANTIES, EXPRESS AND IMPLIED, INCLUDING WITHOUT LIMITATION ANY IMPLIED WARRANTIES OF MERCHANTABILITY, FITNESS FOR A PARTICULAR PURPOSE OR NON-INFRINGEMENT OF THIRD PARTY INTELLECTUAL PROPERTY RIGHTS.

These resources are intended for skilled developers designing with TI products. You are solely responsible for (1) selecting the appropriate TI products for your application, (2) designing, validating and testing your application, and (3) ensuring your application meets applicable standards, and any other safety, security, or other requirements. These resources are subject to change without notice. TI grants you permission to use these resources only for development of an application that uses the TI products described in the resource. Other reproduction and display of these resources is prohibited. No license is granted to any other TI intellectual property right or to any third party intellectual property right. TI disclaims responsibility for, and you will fully indemnify TI and its representatives against, any claims, damages, costs, losses, and liabilities arising out of your use of these resources.

TI's products are provided subject to TI's Terms of Sale ([www.ti.com/legal/termsofsale.html](http://www.ti.com/legal/termsofsale.html)) or other applicable terms available either on [ti.com](http://ti.com) or provided in conjunction with such TI products. TI's provision of these resources does not expand or otherwise alter TI's applicable warranties or warranty disclaimers for TI products.

Mailing Address: Texas Instruments, Post Office Box 655303, Dallas, Texas 75265  
Copyright © 2019, Texas Instruments Incorporated

## Looking for pricing, stock, or lifecycle information?

Click below to explore more details on WIN SOURCE:

 [View OPA2373AIDGSR](#) on WIN SOURCE

 [Texas Instruments](#) Information

## Optimize Your Supply Chain with WIN SOURCE Solutions

-  Global Sourcing Solution
-  Obsolete Management
-  Cost Control Management
-  Shortage Management
-  Alternative Solution
-  Excess Inventory Management