



**THE DATASHEET OF  
OPA2140AIDGKR**



# OPAx140 High-Precision, Low-Noise, Rail-to-Rail Output, 11-MHz, JFET Op Amps

## 1 Features

- Very-low offset drift: 1  $\mu\text{V}/^\circ\text{C}$  maximum
- Very-low offset: 120  $\mu\text{V}$
- Low input bias current: 10 pA maximum
- Very-low 1/f noise: 250 nV<sub>PP</sub>, 0.1 Hz to 10 Hz
- Low noise: 5.1 nV/ $\sqrt{\text{Hz}}$
- Slew rate: 20 V/ $\mu\text{s}$
- Low supply current: 2 mA maximum
- Input voltage range includes V<sub>-</sub> supply
- Single-supply operation: 4.5 V to 36 V
- Dual-supply operation:  $\pm 2.25$  V to  $\pm 18$  V
- No phase reversal
- Packages:
  - Industry-standard SOIC, SON, SOT-23, TSSOP, and VSSOP

## 2 Applications

- [Intra-dc interconnect \(metro\)](#)
- [Semiconductor test](#)
- [Chemistry and gas analyzer](#)
- [DC power supply, ac source, electronic load](#)
- [Data acquisition \(DAQ\)](#)
- [Lab and field instrumentation](#)

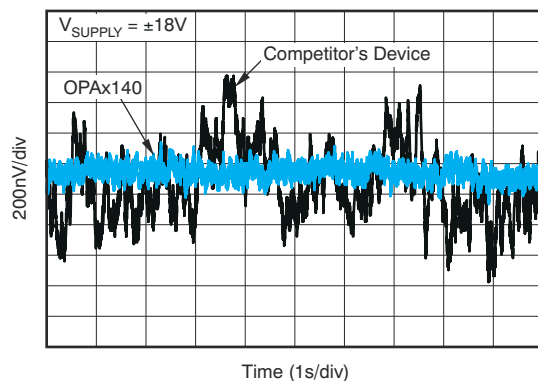

**0.1-Hz to 10-Hz Noise**

## 3 Description

The OPA140, OPA2140, and OPA4140 (OPAx140) operational amplifier (op amp) family is a series of low-power JFET input amplifiers that features good drift and low input bias current. The rail-to-rail output swing and input range that includes V<sub>-</sub> allow designers to take advantage of the low-noise characteristics of JFET amplifiers while also interfacing to modern, single-supply, precision analog-to-digital converters (ADCs) and digital-to-analog converters (DACs).

The OPA140 achieves 11-MHz unity-gain bandwidth and 20-V/ $\mu\text{s}$  slew rate while consuming only 1.8 mA (typical) of quiescent current. This device runs on a single 4.5-V to 36-V supply or dual  $\pm 2.25$ -V to  $\pm 18$ -V supplies.

All versions are fully specified from  $-40^\circ\text{C}$  to  $+125^\circ\text{C}$  for use in the most challenging environments. The OPA140 (single) is available in the 5-pin SOT-23 8-pin VSSOP and 8-pin SOIC packages. The OPA2140 (dual) is available in 8-pin SON, 8-pin VSSOP, and 8-pin SOIC packages. The OPA4140 (quad) is available in the 14-pin SOIC and 14-pin TSSOP packages.

### Device Information

PART NUMBER	CHANNELS	PACKAGE <sup>(1)</sup>
OPA140	Single	D (SOIC, 8)
		DBV (SOT23, 5)
		DGK (VSSOP, 8)
OPA2140	Dual	D (SOIC, 8)
		DRG (SON, 8)
		DGK (VSSOP, 8)
OPA4140	Quad	D (SOIC, 14)
		PW (TSSOP, 14)

(1) For all available packages, see the package option addendum at the end of the data sheet.



## Table of Contents

<b>1 Features</b> .....	1	7.3 Feature Description.....	15
<b>2 Applications</b> .....	1	7.4 Device Functional Modes.....	22
<b>3 Description</b> .....	1	<b>8 Application and Implementation</b> .....	23
<b>4 Revision History</b> .....	2	8.1 Application Information.....	23
<b>5 Pin Configuration and Functions</b> .....	3	8.2 Typical Application.....	23
<b>6 Specifications</b> .....	5	8.3 Power Supply Recommendations.....	24
6.1 Absolute Maximum Ratings.....	5	8.4 Layout.....	24
6.2 ESD Ratings.....	5	<b>9 Device and Documentation Support</b> .....	27
6.3 Recommended Operating Conditions.....	5	9.1 Device Support.....	27
6.4 Thermal Information: OPA140.....	6	9.2 Documentation Support.....	28
6.5 Thermal Information: OPA2140.....	6	9.3 Receiving Notification of Documentation Updates.....	28
6.6 Thermal Information: OPA4140.....	6	9.4 Support Resources.....	28
6.7 Electrical Characteristics.....	7	9.5 Trademarks.....	28
6.8 Typical Characteristics.....	8	9.6 Electrostatic Discharge Caution.....	28
<b>7 Detailed Description</b> .....	15	9.7 Glossary.....	28
7.1 Overview.....	15	<b>10 Mechanical, Packaging, and Orderable Information</b> .....	28
7.2 Functional Block Diagram.....	15		

## 4 Revision History

NOTE: Page numbers for previous revisions may differ from page numbers in the current version.

<b>Changes from Revision E (July 2021) to Revision F (March 2023)</b>	<b>Page</b>
• Changed OPA2140 DRG package from preview to production data.....	1
• Added $\pm$ to input offset voltage and input offset voltage drift values in the <i>Electrical Characteristics</i> .....	7
• Changed 12-bit settling time specification unit from ns to $\mu$ s in the <i>Electrical Characteristics</i> .....	7
• Deleted incorrect power supply voltage parameter from the <i>Electrical Characteristics</i> and moved corrected values to the <i>Recommended Operating Conditions</i> .....	7
• Added thermal-related information to the OPA2140 DRG package in the <i>Thermal Protection</i> section.....	18
• Changed Figure 7-3 and Figure 7-4 for clarity.....	18
• Changed Figure 8-3, <i>Dual Operational Amplifier Board Layout for Noninverting Configuration</i> to show the dual DRG package option.....	26
<b>Changes from Revision D (January 2019) to Revision E (July 2021)</b>	<b>Page</b>
• Added OPA2140 DRG preview package and associated content to data sheet.....	1
<b>Changes from Revision C (August 2016) to Revision D (January 2019)</b>	<b>Page</b>
• Changed Figure 12 x-axis title From: Frequency (Hz) To: Output Amplitude ( $V_{RMS}$ ).....	8
<b>Changes from Revision B (November 2015) to Revision C (August 2016)</b>	<b>Page</b>
• Changed units for $E_n$ Input voltage noise From: $\mu$ V To: nV in <i>Electrical Characteristics</i> : $V_S = 4.5$ V to 36 V; $\pm 2.25$ V to $\pm 18$ V.....	7
<b>Changes from Revision A (August 2010) to Revision B (November 2015)</b>	<b>Page</b>
• Added <i>ESD Ratings</i> table, <i>Feature Description</i> section, <i>Device Functional Modes</i> , <i>Application and Implementation</i> section, <i>Power Supply Recommendations</i> section, <i>Layout</i> section, <i>Device and Documentation Support</i> section, and <i>Mechanical, Packaging, and Orderable Information</i> section .....	1
• Changed title of <a href="#">Table 6-1</a> From: <i>Characteristic Performance Measurements</i> To: <i>Table of Graphs</i> .....	8
• Changed section 7.37 title From: <i>Power Dissipation and Thermal Protection</i> To: <i>Thermal Protection</i> .....	18

## 5 Pin Configuration and Functions

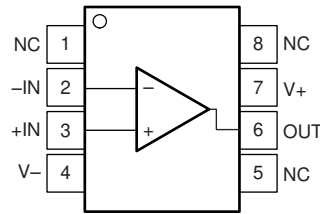

**Figure 5-1. OPA140: D Package, 8-Pin SOIC and DGK Package, 8-Pin VSSOP (Top View)**

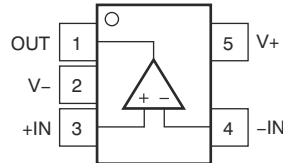

**Figure 5-2. OPA140: DBV Package, 5-Pin SOT-23 (Top View)**

**Table 5-1. Pin Functions: OPA140**

NAME	PIN		TYPE	DESCRIPTION
	OPA140			
	D (SOIC), DGK (VSSOP)	DBV (SOT)		
+IN	3	3	Input	Noninverting input
-IN	2	4	Input	Inverting input
NC	1, 5, 8	—	—	No internal connection (can be left floating)
OUT	6	1	Output	Output
V+	7	5	—	Positive (highest) power supply
V-	4	2	—	Negative (lowest) power supply

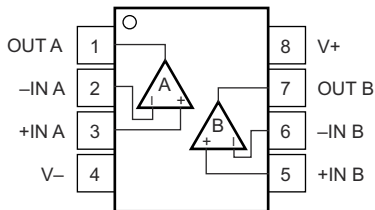

Figure 5-3. OPA2140: D Package, 8-Pin SOIC and DGK Package, 8-Pin VSSOP (Top View)

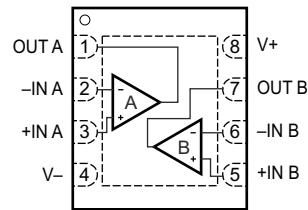

Figure 5-4. OPA2140: DRG Package, 8-Pin SON (Top View)

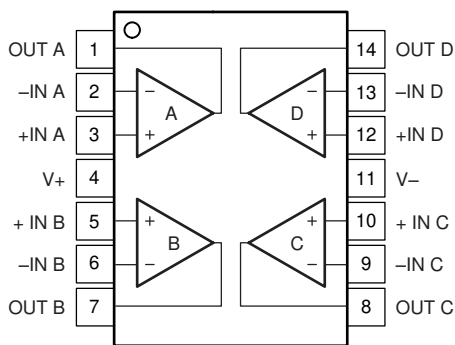

Figure 5-5. OPA4140: D Package, 14-Pin SOIC and PW Package, 14-Pin TSSOP (Top View)

Table 5-2. Pin Functions: OPA2140 and OPA4140

NAME	PIN		TYPE	DESCRIPTION
	OPA2140 D (SOIC), DGK (VSSOP), DRG (SON)	OPA4140 D (SOIC), PW (TSSOP)		
+IN A	3	3	Input	Noninverting input, channel A
+IN B	5	5	Input	Noninverting input, channel B
+IN C	—	10	Input	Noninverting input, channel C
+IN D	—	12	Input	Noninverting input, channel D
-IN A	2	2	Input	Inverting input, channel A
-IN B	6	6	Input	Inverting input, channel B
-IN C	—	9	Input	Inverting input, channel C
-IN D	—	13	Input	Inverting input, channel D
OUT A	1	1	Output	Output, channel A
OUT B	7	7	Output	Output, channel B
OUT C	—	8	Output	Output, channel C
OUT D	—	14	Output	Output, channel D
V+	8	4	—	Positive (highest) power supply
V-	4	11	—	Negative (lowest) power supply
Thermal Pad	DRG Package only	—	—	Thermal pad is internally connected to V-. Solder the thermal pad to a heat spreading plane on the board connected to V-. For DRG package only.

## 6 Specifications

### 6.1 Absolute Maximum Ratings

over operating free-air temperature range (unless otherwise noted)<sup>(1)</sup>

			MIN	MAX	UNIT
V <sub>S</sub>	Supply voltage, (V+) – (V–)	Dual supply	±20		V
		Single supply	40		
	Signal input pins <sup>(2)</sup>	Voltage	(V–) – 0.5	(V+) + 0.5	V
		Current	±10		mA
	Output short-circuit <sup>(3)</sup>	Continuous			
T <sub>A</sub>	Ambient temperature	–55		150	°C
T <sub>J</sub>	Junction temperature			150	°C
T <sub>stg</sub>	Storage temperature	–65		150	°C

- (1) Stresses beyond those listed under *Absolute Maximum Ratings* may cause permanent damage to the device. These are stress ratings only, which do not imply functional operation of the device at these or any other conditions beyond those indicated under *Recommended Operating Conditions*. Exposure to absolute-maximum-rated conditions for extended periods may affect device reliability.
- (2) Input pins are diode-clamped to the power-supply rails. Input signals that can swing more than 0.5 V beyond the supply rails must be current limited to 10 mA or less.
- (3) Short-circuit to V<sub>S</sub> / 2 (ground in symmetrical dual-supply setups), one amplifier per package.

### 6.2 ESD Ratings

			VALUE	UNIT
V <sub>(ESD)</sub>	Electrostatic discharge	Human-body model (HBM), per ANSI/ESDA/JEDEC JS-001 <sup>(1)</sup>	±2000	V
		Charged-device model (CDM), per JEDEC specification JESD22-C101 <sup>(2)</sup>	±500	

- (1) JEDEC document JEP155 states that 500-V HBM allows safe manufacturing with a standard ESD control process.
- (2) JEDEC document JEP157 states that 250-V CDM allows safe manufacturing with a standard ESD control process.

### 6.3 Recommended Operating Conditions

over operating free-air temperature range (unless otherwise noted)

			MIN	NOM	MAX	UNIT
V <sub>S</sub>	Supply voltage, (V+) – (V–)	Dual supply	±2.25		±18	V
		Single supply	4.5		36	
T <sub>A</sub>	Ambient temperature	–40			125	°C

## 6.4 Thermal Information: OPA140

THERMAL METRIC <sup>(1)</sup>		OPA140			UNIT
		D (SOIC)	DBV (SOT)	DGK (VSSOP)	
		8 PINS	5 PINS	8 PINS	
$R_{\theta JA}$	Junction-to-ambient thermal resistance	160	210	180	°C/W
$R_{\theta JC(top)}$	Junction-to-case (top) thermal resistance	75	200	55	°C/W
$R_{\theta JB}$	Junction-to-board thermal resistance	60	110	130	°C/W
$\Psi_{JT}$	Junction-to-top characterization parameter	9	40	N/A	°C/W
$\Psi_{JB}$	Junction-to-board characterization parameter	50	105	120	°C/W
$R_{\theta JC(bot)}$	Junction-to-case (bottom) thermal resistance	N/A	N/A	N/A	°C/W

(1) For more information about traditional and new thermal metrics, see the [Semiconductor and IC Package Thermal Metrics](#) application report.

## 6.5 Thermal Information: OPA2140

THERMAL METRIC <sup>(1)</sup>		OPA2140			UNIT
		D (SOIC)	DGK (VSSOP)	DRG (SON)	
		8 PINS	8 PINS	8 PINS	
$R_{\theta JA}$	Junction-to-ambient thermal resistance	160	180	50.7	°C/W
$R_{\theta JC(top)}$	Junction-to-case (top) thermal resistance	75	55	50.6	°C/W
$R_{\theta JB}$	Junction-to-board thermal resistance	60	130	23.3	°C/W
$\Psi_{JT}$	Junction-to-top characterization parameter	9	N/A	0.9	°C/W
$\Psi_{JB}$	Junction-to-board characterization parameter	50	120	23.3	°C/W
$R_{\theta JC(bot)}$	Junction-to-case (bottom) thermal resistance	N/A	N/A	7.8	°C/W

(1) For more information about traditional and new thermal metrics, see the [Semiconductor and IC Package Thermal Metrics](#) application report.

## 6.6 Thermal Information: OPA4140

THERMAL METRIC <sup>(1)</sup>		OPA4140		UNIT
		D (SOIC)	PW (TSSOP)	
		14 PINS	14 PINS	
$R_{\theta JA}$	Junction-to-ambient thermal resistance	97	135	°C/W
$R_{\theta JC(top)}$	Junction-to-case (top) thermal resistance	56	45	°C/W
$R_{\theta JB}$	Junction-to-board thermal resistance	53	66	°C/W
$\Psi_{JT}$	Junction-to-top characterization parameter	19	N/A	°C/W
$\Psi_{JB}$	Junction-to-board characterization parameter	46	60	°C/W
$R_{\theta JC(bot)}$	Junction-to-case (bottom) thermal resistance	N/A	N/A	°C/W

(1) For more information about traditional and new thermal metrics, see the [Semiconductor and IC Package Thermal Metrics](#) application report.

## 6.7 Electrical Characteristics

at  $T_A = 25^\circ\text{C}$ ,  $V_S = 4.5\text{ V}$  ( $\pm 2.25$ ) to  $36\text{ V}$  ( $\pm 18\text{ V}$ ),  $R_L = 2\text{ k}\Omega$  connected to midsupply, and  $V_{CM} = V_{OUT} = \text{midsupply}$  (unless otherwise noted)

PARAMETER		TEST CONDITIONS	MIN	TYP	MAX	UNIT
<b>OFFSET VOLTAGE</b>						
$V_{OS}$	Input offset voltage	$V_S = \pm 18\text{ V}$ , $T_A = -40^\circ\text{C}$ to $+125^\circ\text{C}$		$\pm 30$	$\pm 120$	$\mu\text{V}$
		$V_S = \pm 2.25\text{ V}$ to $\pm 18\text{ V}$ , $T_A = -40^\circ\text{C}$ to $+125^\circ\text{C}$			$\pm 220$	
$dV_{OS}/dT$	Input offset voltage drift	$V_S = \pm 18\text{ V}$ , $T_A = -40^\circ\text{C}$ to $+125^\circ\text{C}$		$\pm 0.35$	$\pm 1$	$\mu\text{V}/^\circ\text{C}$
PSRR	Power-supply rejection ratio	$V_S = \pm 2.25\text{ V}$ to $\pm 18\text{ V}$ , $T_A = -40^\circ\text{C}$ to $+125^\circ\text{C}$		$\pm 0.1$	$\pm 0.5$	$\mu\text{V}/\text{V}$
<b>INPUT BIAS CURRENT</b>						
$I_B$	Input bias current			$\pm 0.5$	$\pm 10$	$\mu\text{A}$
		$T_A = -40^\circ\text{C}$ to $+125^\circ\text{C}$				$\pm 3$
$I_{OS}$	Input offset current			$\pm 0.5$	$\pm 10$	$\mu\text{A}$
		$T_A = -40^\circ\text{C}$ to $+125^\circ\text{C}$				$\pm 1$
<b>NOISE</b>						
$E_n$	Input voltage noise	$f = 0.1\text{ Hz}$ to $10\text{ Hz}$		250		$\text{nV}_{PP}$
		$f = 0.1\text{ Hz}$ to $10\text{ Hz}$		42		$\text{nV}_{RMS}$
$e_n$	Input voltage noise density	$f = 10\text{ Hz}$		8		$\text{nV}/\sqrt{\text{Hz}}$
		$f = 100\text{ Hz}$		5.8		
		$f = 1\text{ kHz}$		5.1		
$I_n$	Input current noise density	$f = 1\text{ kHz}$		0.8		$\text{fA}/\sqrt{\text{Hz}}$
<b>INPUT VOLTAGE RANGE</b>						
$V_{CM}$	Common-mode voltage	$T_A = -40^\circ\text{C}$ to $+125^\circ\text{C}$		$(V-) - 0.1$	$(V+) - 3.5$	$\text{V}$
CMRR	Common-mode rejection ratio	$V_S = \pm 18\text{ V}$ , $V_{CM} = (V-) - 0.1\text{ V}$ to $(V+) - 3.5\text{ V}$		126	140	$\text{dB}$
			$T_A = -40^\circ\text{C}$ to $+125^\circ\text{C}$		120	
<b>INPUT IMPEDANCE</b>						
$Z_{ID}$	Differential			$10^{13} \parallel 10$		$\Omega \parallel \text{pF}$
$Z_{IC}$	Common-mode	$V_{CM} = (V-) - 0.1\text{ V}$ to $(V+) - 3.5\text{ V}$		$10^{13} \parallel 7$		$\Omega \parallel \text{pF}$
<b>OPEN-LOOP GAIN</b>						
$A_{OL}$	Open-loop voltage gain	$V_O = (V-) + 0.35\text{ V}$ to $(V+) - 0.35\text{ V}$ , $R_L = 10\text{ k}\Omega$		120	126	$\text{dB}$
		$V_O = (V-) + 0.35\text{ V}$ to $(V+) - 0.35\text{ V}$ , $R_L = 2\text{ k}\Omega$		114	126	
		$T_A = -40^\circ\text{C}$ to $+125^\circ\text{C}$		108		
<b>FREQUENCY RESPONSE</b>						
BW	Gain bandwidth product			11		$\text{MHz}$
SR	Slew rate			20		$\text{V}/\mu\text{s}$
$t_s$	Settling time	12 bits		0.88		$\mu\text{s}$
		16 bits		1.6		
$t_{OR}$	Overload recovery time			600		$\text{ns}$
THD+N	Total harmonic distortion + noise	1 kHz, $G = +1$ , $V_O = 3.5 V_{RMS}$		0.00005%		
<b>OUTPUT</b>						
$V_O$	Voltage output	$R_L = 10\text{ k}\Omega$ , $A_{OL} \geq 108\text{ dB}$		$(V-) + 0.2$	$(V+) - 0.2$	$\text{V}$
		$R_L = 2\text{ k}\Omega$ , $A_{OL} \geq 108\text{ dB}$		$(V-) + 0.35$	$(V+) - 0.35$	
$I_{SC}$	Short-circuit current	Source		36		$\text{mA}$
		Sink		-30		
$C_{LOAD}$	Capacitive load drive			See <i>Typical Characteristics</i>		
$Z_O$	Open-loop output impedance	$f = 1\text{ MHz}$ , $I_O = 0\text{ A}$ (See <i>Typical Characteristics</i> )		16		$\Omega$

## 6.7 Electrical Characteristics (continued)

at  $T_A = 25^\circ\text{C}$ ,  $V_S = 4.5\text{ V} (\pm 2.25)$  to  $36\text{ V} (\pm 18\text{ V})$ ,  $R_L = 2\text{ k}\Omega$  connected to midsupply, and  $V_{CM} = V_{OUT} = \text{midsupply}$  (unless otherwise noted)

PARAMETER		TEST CONDITIONS	MIN	TYP	MAX	UNIT
<b>POWER SUPPLY</b>						
$I_Q$	Quiescent current per amplifier	$I_O = 0\text{ mA}$		1.8	2	mA
		$T_A = -40^\circ\text{C}$ to $+125^\circ\text{C}$			2.7	
<b>CHANNEL SEPARATION</b>						
	Channel separation	At dc		0.02		$\mu\text{V/V}$
		At 100 kHz		10		

## 6.8 Typical Characteristics

at  $T_A = 25^\circ\text{C}$ ,  $V_S = \pm 18\text{ V}$ ,  $R_L = 2\text{ k}\Omega$  connected to midsupply, and  $V_{CM} = V_{OUT} = \text{midsupply}$  (unless otherwise noted)

**Table 6-1. Table of Graphs**

DESCRIPTION	FIGURE
Offset Voltage Production Distribution	<a href="#">Figure 6-1</a>
Offset Voltage Drift Distribution	<a href="#">Figure 6-2</a>
Offset Voltage vs Common-Mode Voltage (Maximum Supply)	<a href="#">Figure 6-3</a>
Input Offset Voltage vs Temperature	<a href="#">Figure 6-4</a>
$I_B$ vs Common-Mode Voltage	<a href="#">Figure 6-5</a>
Output Voltage Swing vs Output Current	<a href="#">Figure 6-6</a>
CMRR and PSRR vs Frequency (RTI)	<a href="#">Figure 6-7</a>
Common-Mode Rejection Ratio vs Temperature	<a href="#">Figure 6-8</a>
0.1-Hz to 10-Hz Noise	<a href="#">Figure 6-9</a>
Input Voltage Noise Density vs Frequency	<a href="#">Figure 6-10</a>
THD+N Ratio vs Frequency (80-kHz AP Bandwidth)	<a href="#">Figure 6-11</a>
THD+N Ratio vs Output Amplitude	<a href="#">Figure 6-12</a>
Quiescent Current vs Temperature	<a href="#">Figure 6-13</a>
Quiescent Current vs Supply Voltage	<a href="#">Figure 6-14</a>
Gain and Phase vs Frequency	<a href="#">Figure 6-15</a>
Closed-Loop Gain vs Frequency	<a href="#">Figure 6-16</a>
Open-Loop Gain vs Temperature	<a href="#">Figure 6-17</a>
Open-Loop Output Impedance vs Frequency	<a href="#">Figure 6-18</a>
Small-Signal Overshoot vs Capacitive Load ( $G = 1$ )	<a href="#">Figure 6-19</a>
Small-Signal Overshoot vs Capacitive Load ( $G = -1$ )	<a href="#">Figure 6-20</a>
No Phase Reversal	<a href="#">Figure 6-21</a>
Maximum Output Voltage vs Frequency	<a href="#">Figure 6-22</a>
Positive Overload Recovery	<a href="#">Figure 6-23</a>
Negative Overload Recovery	<a href="#">Figure 6-24</a>
Large-Signal Positive and Negative Settling Time	<a href="#">Figure 6-25,</a> <a href="#">Figure 6-26</a>
Small-Signal Step Response ( $G = 1$ )	<a href="#">Figure 6-27</a>
Small-Signal Step Response ( $G = -1$ )	<a href="#">Figure 6-28</a>
Large-Signal Step Response ( $G = 1$ )	<a href="#">Figure 6-29</a>
Large-Signal Step Response ( $G = -1$ )	<a href="#">Figure 6-30</a>
Short-Circuit Current vs Temperature	<a href="#">Figure 6-31</a>

## 6.8 Typical Characteristics

at  $T_A = 25^\circ\text{C}$ ,  $V_S = \pm 18\text{ V}$ ,  $R_L = 2\text{ k}\Omega$  connected to midsupply, and  $V_{CM} = V_{OUT} = \text{midsupply}$  (unless otherwise noted)

**Table 6-1. Table of Graphs (continued)**

DESCRIPTION	FIGURE
Channel Separation vs Frequency	<a href="#">Figure 6-32</a>

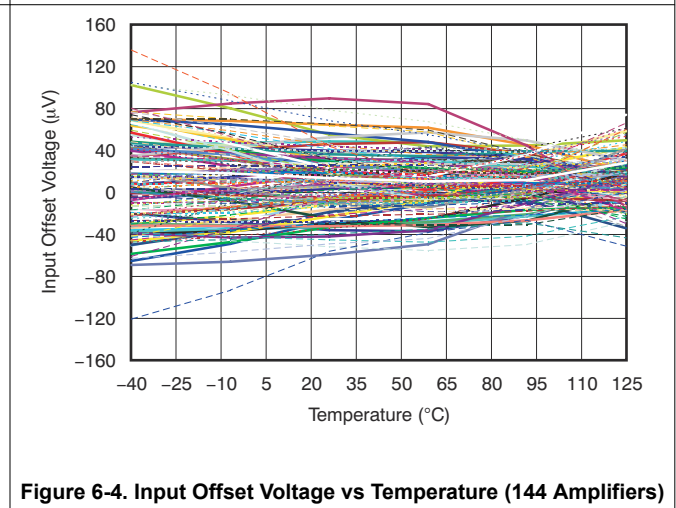
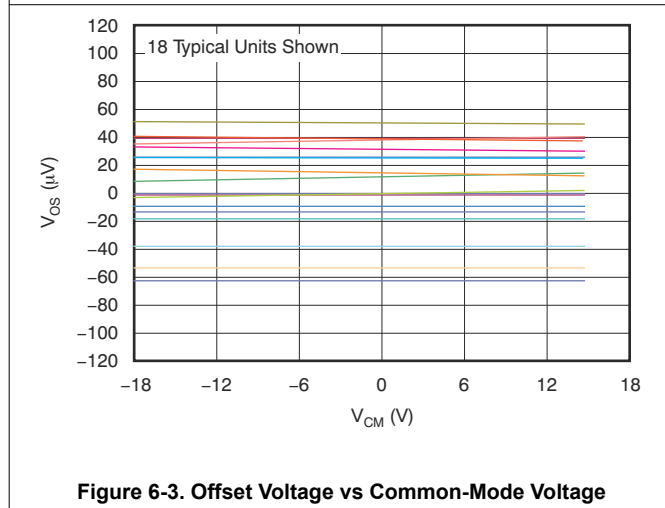
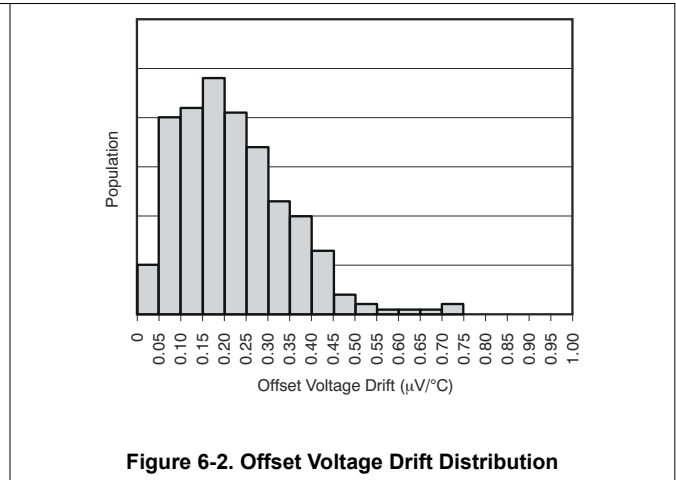
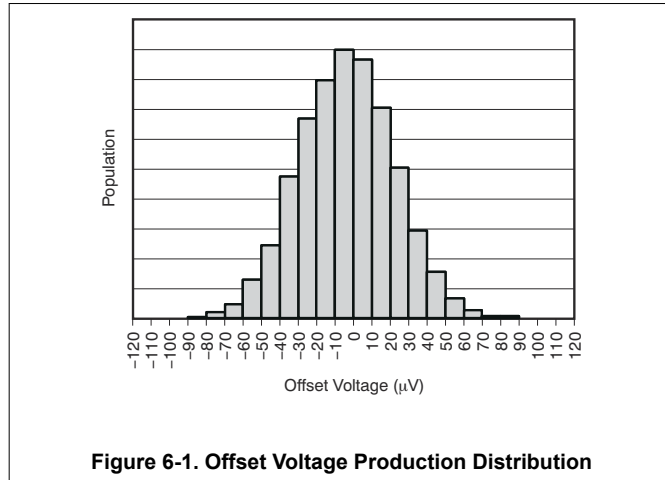

## 6.8 Typical Characteristics (continued)

at  $T_A = 25^\circ\text{C}$ ,  $V_S = \pm 18\text{ V}$ ,  $R_L = 2\text{ k}\Omega$  connected to midsupply, and  $V_{CM} = V_{OUT} = \text{midsupply}$  (unless otherwise noted)

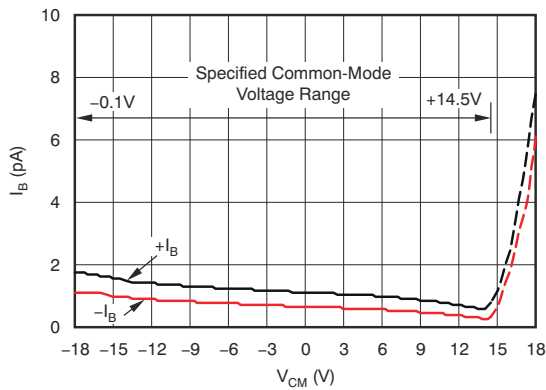

Figure 6-5.  $I_B$  vs Common-Mode Voltage

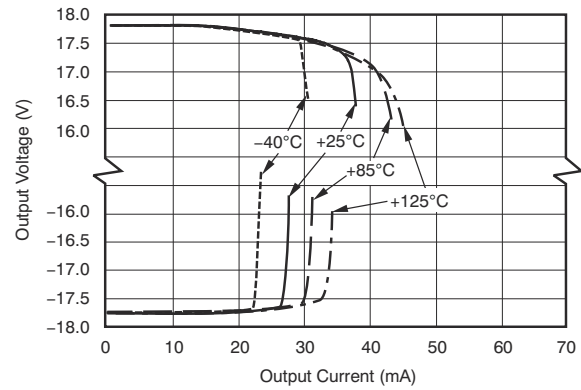

Figure 6-6. Output Voltage Swing vs Output Current (Maximum Supply)

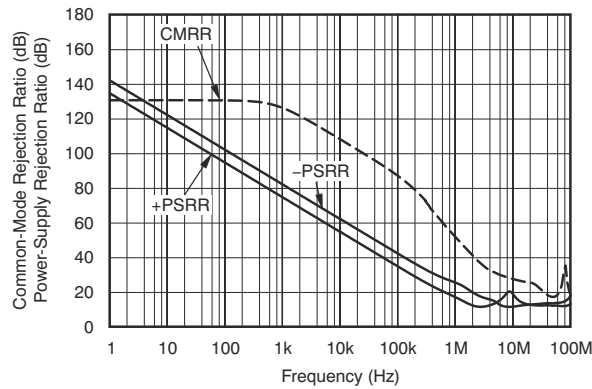

Figure 6-7. CMRR and PSRR vs Frequency (Referred to Input)

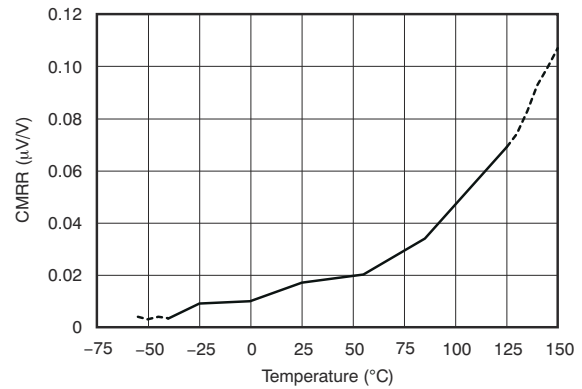

Figure 6-8. Common-Mode Rejection Ratio vs Temperature

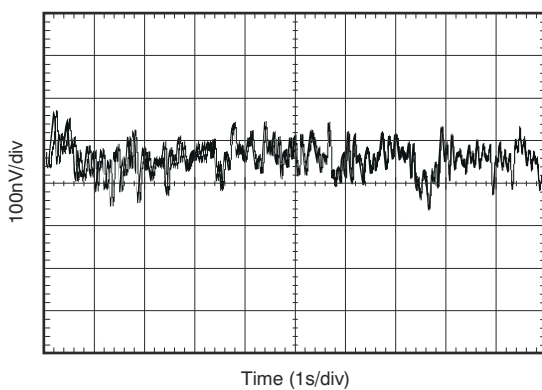

Figure 6-9. 0.1-Hz to 10-Hz Noise

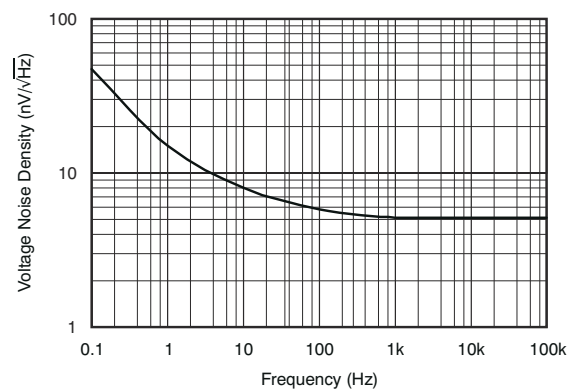
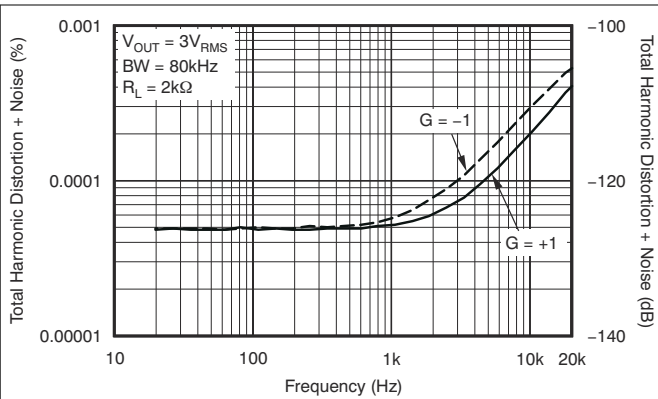

Figure 6-10. Input Voltage Noise Density vs Frequency

### 6.8 Typical Characteristics (continued)

at  $T_A = 25^\circ\text{C}$ ,  $V_S = \pm 18\text{ V}$ ,  $R_L = 2\text{ k}\Omega$  connected to midsupply, and  $V_{CM} = V_{OUT} = \text{midsupply}$  (unless otherwise noted)



**Figure 6-11. THD+N Ratio vs Frequency**

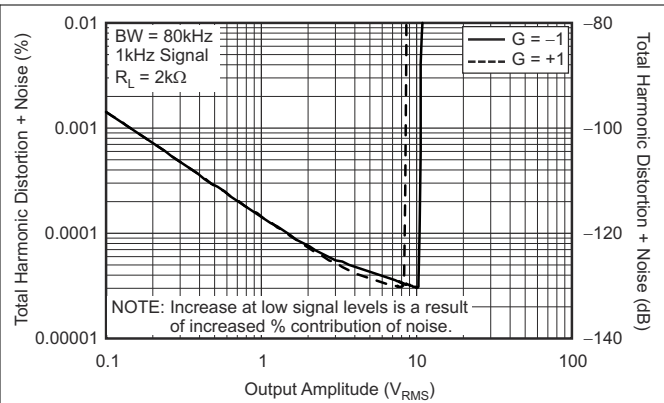

**Figure 6-12. THD+N Ratio vs Output Amplitude**

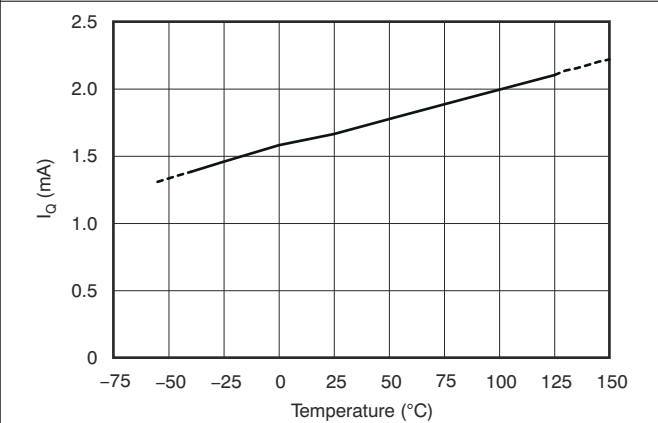

**Figure 6-13. Quiescent Current vs Temperature**

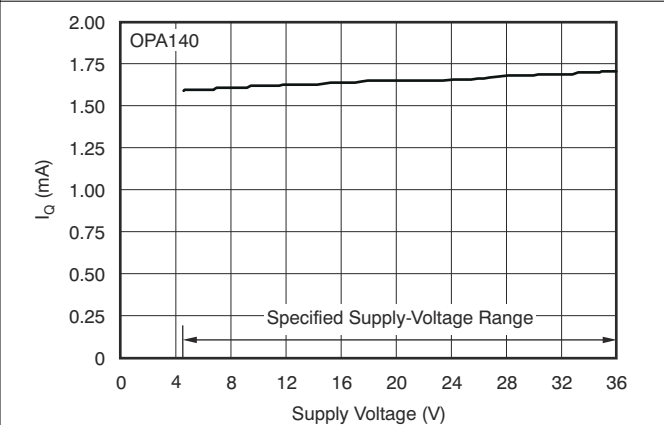

**Figure 6-14. Quiescent Current vs Supply Voltage**

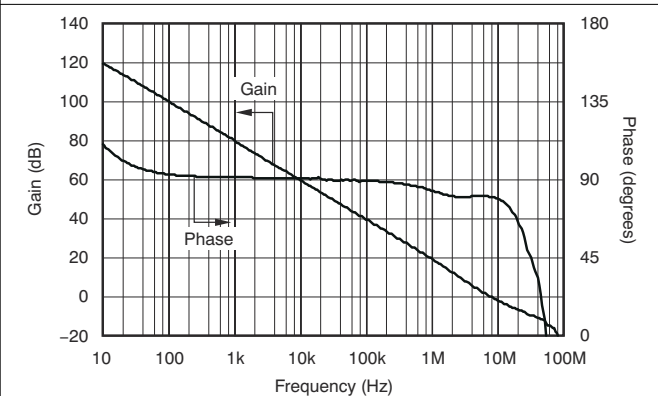

**Figure 6-15. Gain and Phase vs Frequency**

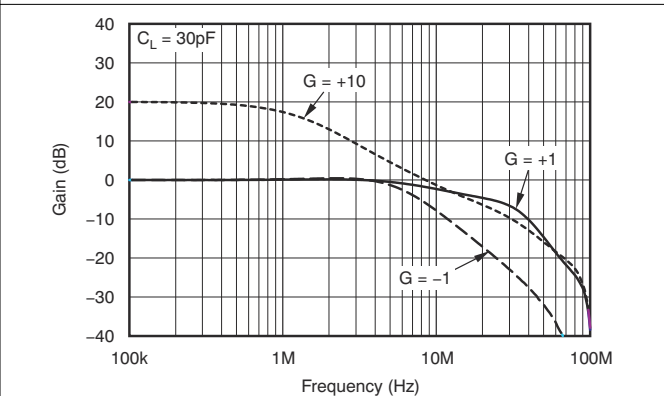

**Figure 6-16. Closed-Loop Gain vs Frequency**

### 6.8 Typical Characteristics (continued)

at  $T_A = 25^\circ\text{C}$ ,  $V_S = \pm 18\text{ V}$ ,  $R_L = 2\text{ k}\Omega$  connected to midsupply, and  $V_{CM} = V_{OUT} = \text{midsupply}$  (unless otherwise noted)

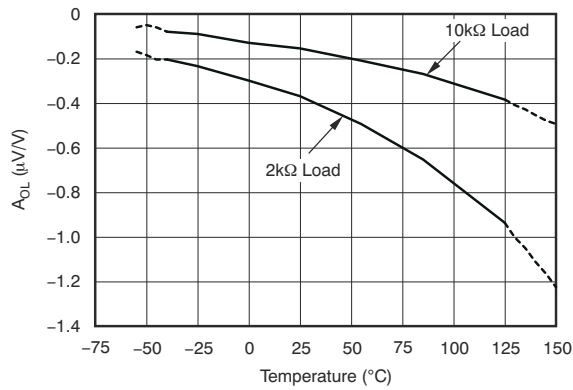

**Figure 6-17. Open-Loop Gain vs Temperature**

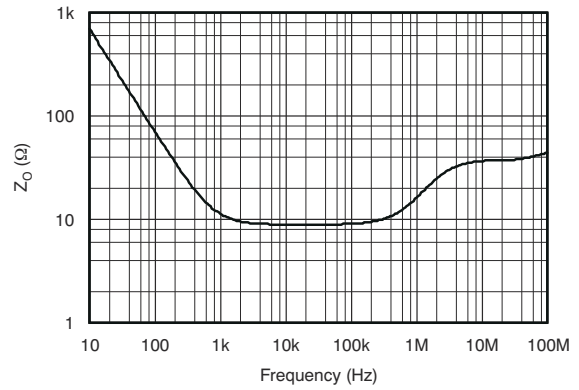

**Figure 6-18. Open-Loop Output Impedance vs Frequency**

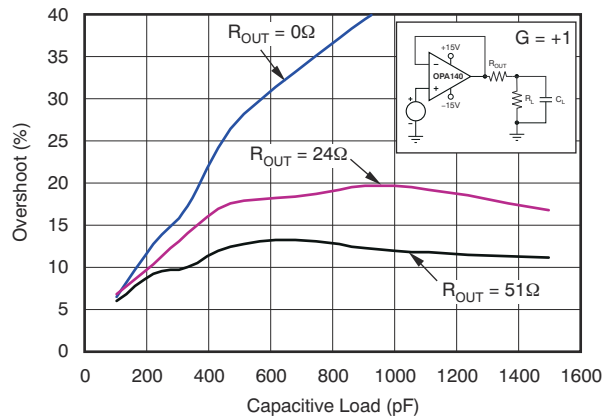

**Figure 6-19. Small-Signal Overshoot vs Capacitive Load (100-mV Output Step)**

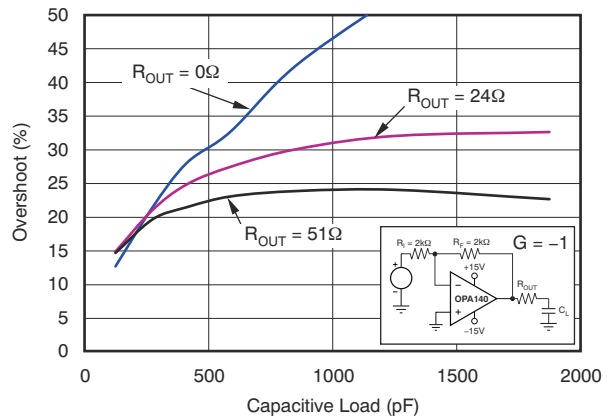

**Figure 6-20. Small-Signal Overshoot vs Capacitive Load (100-mV Output Step)**

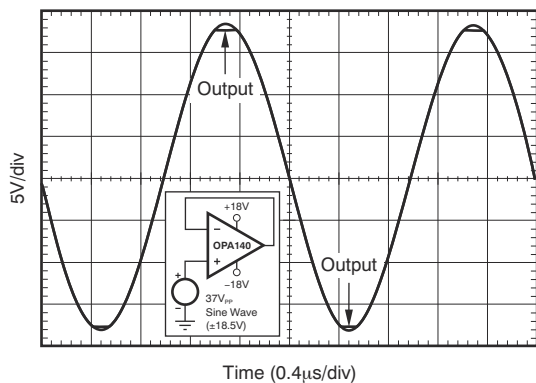

**Figure 6-21. No Phase Reversal**

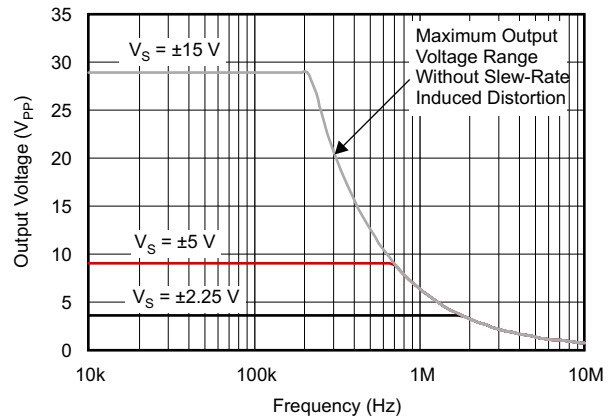

**Figure 6-22. Maximum Output Voltage vs Frequency**

### 6.8 Typical Characteristics (continued)

at  $T_A = 25^\circ\text{C}$ ,  $V_S = \pm 18\text{ V}$ ,  $R_L = 2\text{ k}\Omega$  connected to midsupply, and  $V_{CM} = V_{OUT} = \text{midsupply}$  (unless otherwise noted)

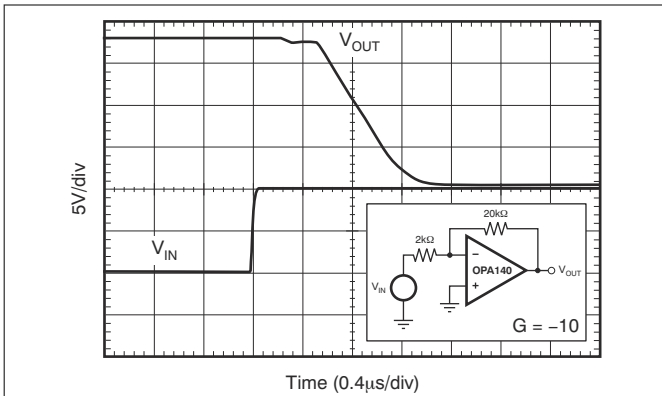

**Figure 6-23. Positive Overload Recovery**

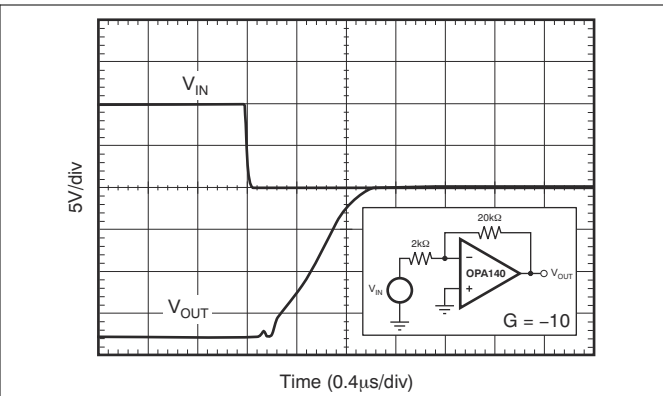

**Figure 6-24. Negative Overload Recovery**

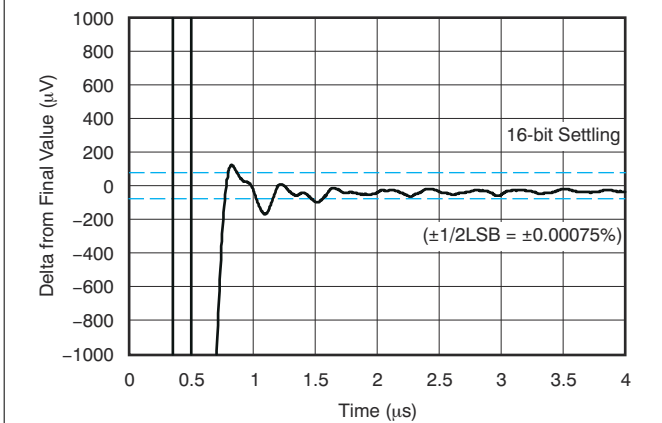

**Figure 6-25. Large-Signal Positive Settling Time (10-V Step)**

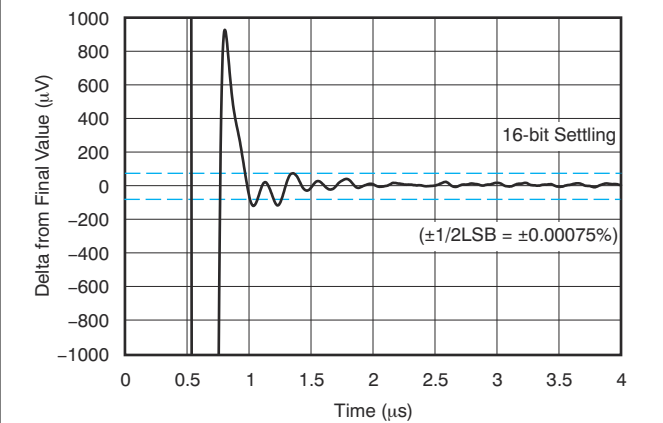

**Figure 6-26. Large-Signal Negative Settling Time (10-V Step)**

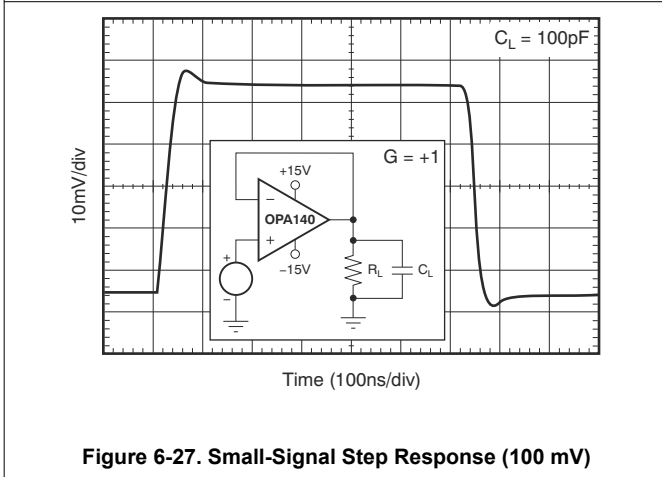

**Figure 6-27. Small-Signal Step Response (100 mV)**

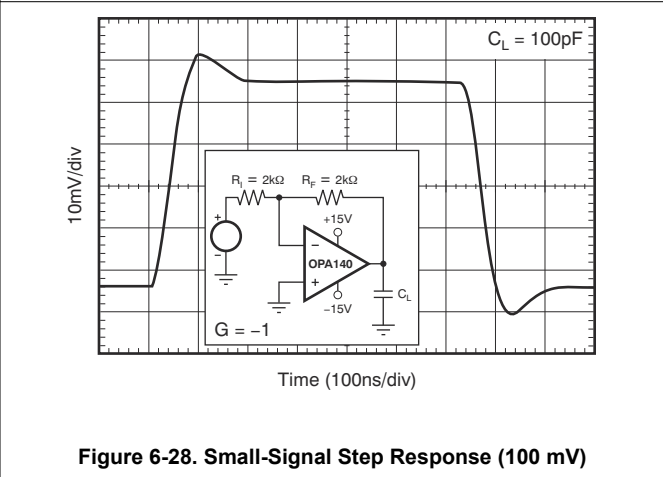

**Figure 6-28. Small-Signal Step Response (100 mV)**

## 6.8 Typical Characteristics (continued)

at  $T_A = 25^\circ\text{C}$ ,  $V_S = \pm 18\text{ V}$ ,  $R_L = 2\text{ k}\Omega$  connected to midsupply, and  $V_{CM} = V_{OUT} = \text{midsupply}$  (unless otherwise noted)

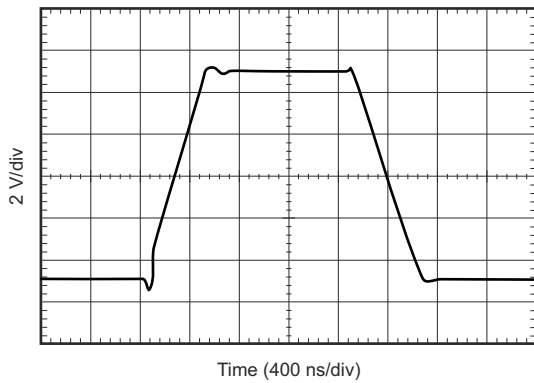

**Figure 6-29. Large-Signal Step Response**

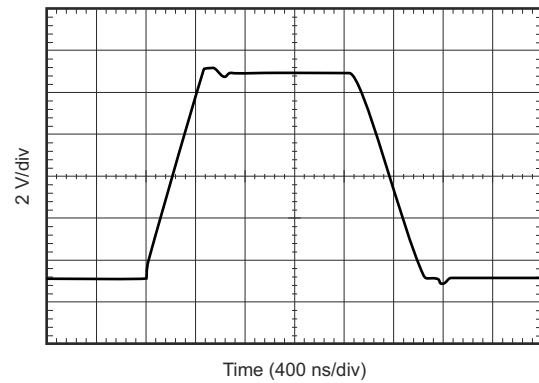

**Figure 6-30. Large-Signal Step Response**

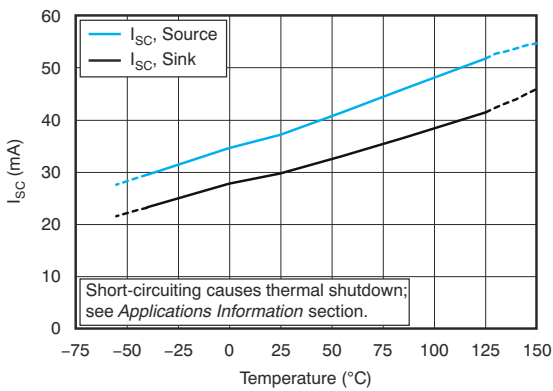

**Figure 6-31. Short Circuit Current vs Temperature**

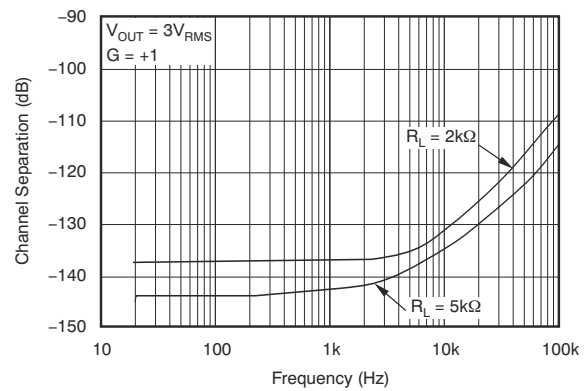

**Figure 6-32. Channel Separation vs Frequency**

## 7 Detailed Description

### 7.1 Overview

The OPAx140 family of operational amplifiers is a series of low-power JFET input amplifiers that feature excellent drift performance and low input bias current. The rail-to-rail output swing and input range that includes  $V^-$  allow designers to use the low-noise characteristics of JFET amplifiers while also interfacing to modern, single-supply, precision analog-to-digital converters (ADCs) and digital-to-analog converters (DACs). The OPAx140 series achieves 11-MHz unity-gain bandwidth and 20-V/ $\mu$ s slew rate, and consumes only 1.8 mA (typical) of quiescent current. These devices operate on a single 4.5-V to 36-V supply or dual  $\pm 2.25$ -V to  $\pm 18$ -V supplies.

[Section 7.2](#) shows the simplified diagram of the OPAx140.

### 7.2 Functional Block Diagram

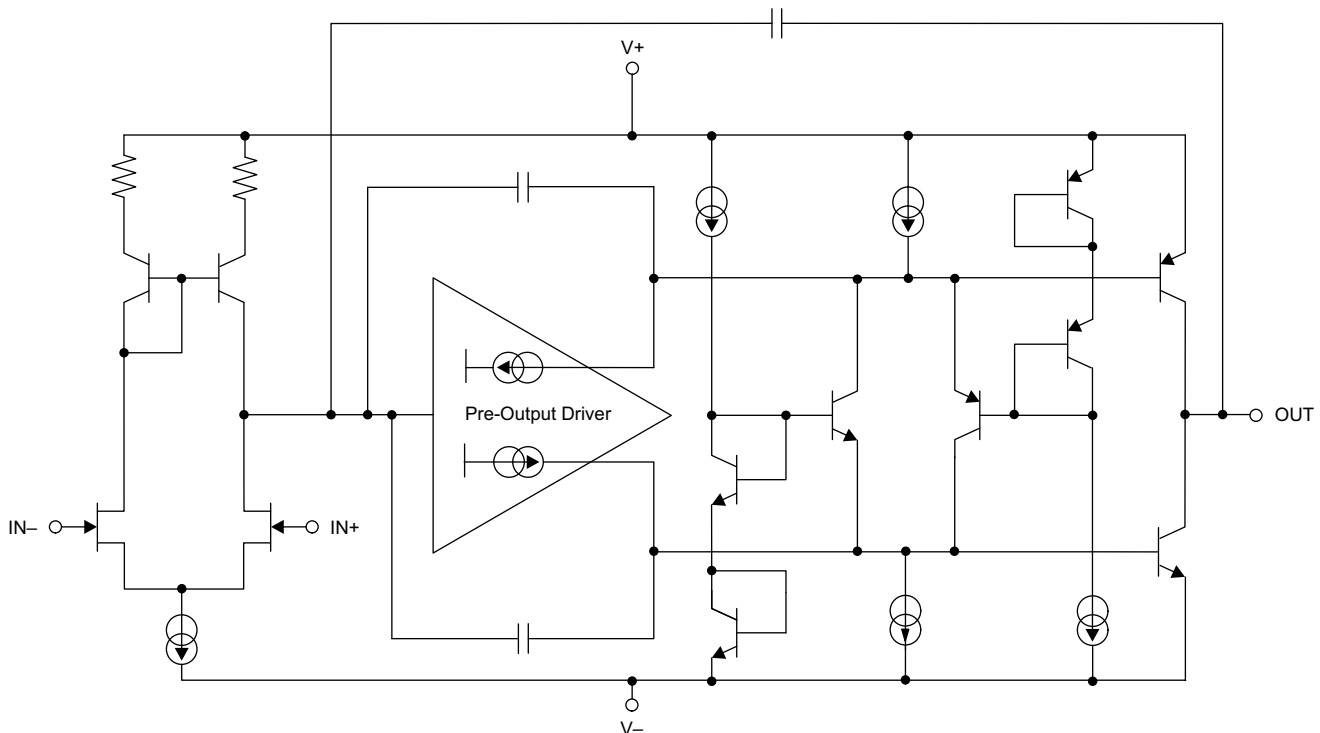

### 7.3 Feature Description

#### 7.3.1 Operating Voltage

The OPA140, OPA2140, and OPA4140 series of op amps can be used with single or dual supplies from an operating range of  $V_S = 4.5\text{ V}$  ( $\pm 2.25\text{ V}$ ) and up to  $V_S = 36\text{ V}$  ( $\pm 18\text{ V}$ ). These devices do not require symmetrical supplies, but only a minimum supply voltage of 4.5 V ( $\pm 2.25\text{ V}$ ). For  $V_S$  less than  $\pm 3.5\text{ V}$ , the common-mode input range does not include midsupply. Supply voltages higher than 40 V can permanently damage the device; see [Section 6.1](#). Key parameters are specified over the operating temperature range,  $T_A = -40^\circ\text{C}$  to  $125^\circ\text{C}$ . Key parameters that vary over the supply voltage or temperature range are shown in [Section 6.8](#) of this data sheet.

### 7.3.2 Capacitive Load and Stability

The dynamic characteristics of the OPAx140 have been optimized for commonly encountered gains, loads, and operating conditions. The combination of low closed-loop gain and high capacitive loads decreases the phase margin of the amplifier and can lead to gain peaking or oscillations. As a result, heavier capacitive loads must be isolated from the output. The simplest way to achieve this isolation is to add a small resistor ( $R_{OUT}$  equal to 50  $\Omega$ , for example) in series with the output.

Figure 6-19 and Figure 6-20 illustrate graphs of *Small-Signal Overshoot vs Capacitive Load* for several values of  $R_{OUT}$ . Also, see the [Feedback Plots Define Op Amp AC Performance Application Bulletin](#), available for download from [www.ti.com](http://www.ti.com), for details of analysis techniques and application circuits.

### 7.3.3 Output Current Limit

The output current of the OPAx140 series is limited by internal circuitry to 36 mA/–30 mA (sourcing/sinking), to protect the device if the output is accidentally shorted. This short circuit current depends on temperature, as shown in Figure 6-31.

### 7.3.4 Noise Performance

Figure 7-1 shows the total circuit noise for varying source impedances with the operational amplifier in a unity-gain configuration (with no feedback resistor network and therefore no additional noise contributions). The OPA140 and OPA211 are shown with total circuit noise calculated. The op amp contributes both a voltage noise component and a current noise component. The voltage noise is commonly modeled as a time-varying component of the offset voltage. The current noise is modeled as the time-varying component of the input bias current and reacts with the source resistance to create a voltage component of noise. Therefore, the lowest noise op amp for a given application depends on the source impedance. For low source impedance, current noise is negligible, and voltage noise generally dominates. The OPAx140 family has both low voltage noise and extremely low current noise because of the FET input of the op amp. As a result, the current noise contribution of the OPAx140 series is negligible for any practical source impedance, which makes these devices the better choice for applications with high source impedance.

The equation in Figure 7-1 shows the calculation of the total circuit noise, with these parameters:

- $e_n$  = voltage noise
- $I_n$  = current noise
- $R_S$  = source impedance
- $k$  = Boltzmann's constant =  $1.38 \times 10^{-23}$  J/K
- $T$  = temperature in kelvins (K)

For more details on calculating noise, see [Section 7.3.5](#).

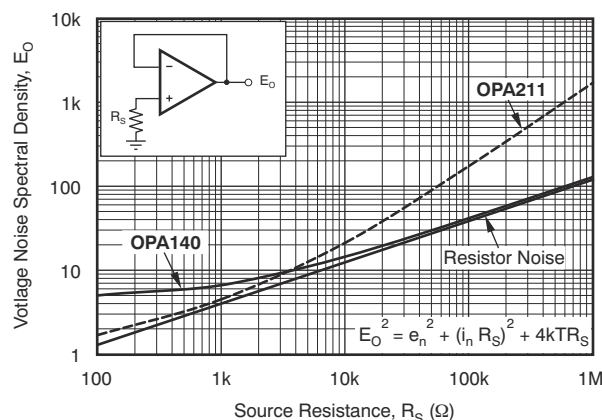

**Figure 7-1. Noise Performance of the OPA140 and OPA211 in Unity-Gain Buffer Configuration**

### 7.3.5 Basic Noise Calculations

Low-noise circuit design requires careful analysis of all noise sources. External noise sources can dominate in many cases; consider the effect of source resistance on overall op amp noise performance. Total noise of the circuit is the root-sum-square combination of all noise components.

The resistive portion of the source impedance produces thermal noise proportional to the square root of the resistance. This function is plotted in Figure 7-1. The source impedance is usually fixed; consequently, select the op amp and the feedback resistors to minimize the respective contributions to the total noise.

Figure 7-2 illustrates both noninverting (A) and inverting (B) op amp circuit configurations with gain. In circuit configurations with gain, the feedback network resistors also contribute noise. In general, the current noise of the op amp reacts with the feedback resistors to create additional noise components. However, the extremely low current noise of the OPAx140 means that the current noise contribution can be neglected.

The feedback resistor values can generally be chosen to make these noise sources negligible. Low impedance feedback resistors load the output of the amplifier. The equations for total noise are shown for both configurations.

A) Noise in Noninverting Gain Configuration

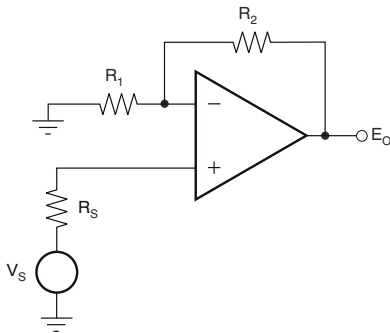

Noise at the output:

$$E_o^2 = \left(1 + \frac{R_2}{R_1}\right)^2 e_n^2 + \left(\frac{R_2}{R_1}\right)^2 e_1^2 + e_2^2 + \left(1 + \frac{R_2}{R_1}\right)^2 e_s^2$$

Where  $e_s = \sqrt{4kTR_s}$  = thermal noise of  $R_s$

$e_1 = \sqrt{4kTR_1}$  = thermal noise of  $R_1$

$e_2 = \sqrt{4kTR_2}$  = thermal noise of  $R_2$

B) Noise in Inverting Gain Configuration

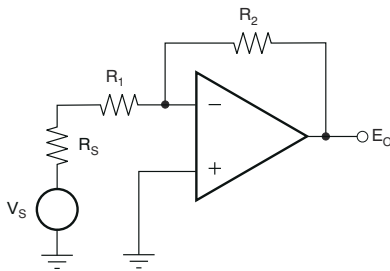

Noise at the output:

$$E_o^2 = \left(1 + \frac{R_2}{R_1 + R_s}\right)^2 e_n^2 + \left(\frac{R_2}{R_1 + R_s}\right)^2 e_1^2 + e_2^2 + \left(\frac{R_2}{R_1 + R_s}\right)^2 e_s^2$$

Where  $e_s = \sqrt{4kTR_s}$  = thermal noise of  $R_s$

$e_1 = \sqrt{4kTR_1}$  = thermal noise of  $R_1$

$e_2 = \sqrt{4kTR_2}$  = thermal noise of  $R_2$

For the OPAx140 series of operational amplifiers at 1 kHz,  $e_n = 5.1 \text{ nV}/\sqrt{\text{Hz}}$ .

**Figure 7-2. Noise Calculation in Gain Configurations**

### 7.3.6 Phase-Reversal Protection

The OPA140, OPA2140, and OPA4140 family has internal phase-reversal protection. Many FET- and bipolar-input op amps exhibit a phase reversal when the input is driven beyond the linear common-mode range. This condition is most often encountered in noninverting circuits when the input is driven beyond the specified common-mode voltage range, causing the output to reverse into the opposite rail. The input circuitry of the OPA140, OPA2140, and OPA4140 prevents phase reversal with excessive common-mode voltage; instead, the output limits into the appropriate rail (see Figure 6-21).

### 7.3.7 Thermal Protection

The OPAx140 series of op amps are capable of driving 2-kΩ loads with power-supply voltages of up to ±18 V over the specified temperature range. In a single-supply configuration, where the load is connected to the negative supply voltage, the minimum load resistance is 2.8 kΩ at a supply voltage of 36 V. For lower supply voltages (either single-supply or symmetrical supplies), a lower load resistance can be used, as long as the output current does not exceed 13 mA; otherwise, the device short circuit current protection circuit can activate.

Internal power dissipation increases when operating at high supply voltages. Copper leadframe construction used in the OPA140, OPA2140, and OPA4140 series devices improves heat dissipation compared to conventional materials. Printed-circuit-board (PCB) layout can also help reduce a possible increase in junction temperature ( $T_J$ ). Wide copper traces help dissipate the heat by acting as an additional heatsink. Temperature rise can be further minimized by soldering the devices directly to the PCB rather than using a socket.

Although the output current is limited by internal protection circuitry, accidental shorting of one or more output channels of a device can result in excessive heating. For instance, when an output is shorted to mid-supply, the typical short-circuit current of 36 mA leads to an internal power dissipation of over 600 mW at a supply of ±18 V. Total power dissipation ( $P_D$ ) includes both the quiescent power dissipation ( $P_{DQ}$ ) and the power dissipation due to the load ( $P_{DL}$ ).

In the case of a dual OPA2140 in an 8-pin VSSOP package (the junction-to-ambient thermal resistance,  $R_{\theta JA}$ , is 180°C/W), such power dissipation can lead the die temperature to be 220°C above ambient temperature ( $T_A$ ), when both channels are shorted. This temperature increase significantly decreases the operating life of the device.  $T_J$  can be approximated using Equation 1.

$$T_J = T_A + (P_{DQ} + P_{DL}) \times R_{\theta JA} \quad (1)$$

To prevent excessive heating, the OPAx140 series has an internal thermal shutdown circuit that shuts down the device if the die temperature exceeds approximately 180°C. When this thermal shutdown circuit activates, a built-in hysteresis of 15°C makes sure that the die temperature must drop to approximately 165°C before the device switches on again.

Additional consideration is needed for the combination of maximum operating voltage, maximum operating temperature, load, and package type. Figure 7-3 and Figure 7-4 show several practical considerations when evaluating the OPA2140 (dual version) and the OPA4140 (quad version).

As an example, the OPA4140 has a maximum total quiescent current of 10.8 mA (2.7 mA/channel) over temperature. The 14-pin TSSOP package has a typical  $R_{\theta JA}$  of 135°C/W. This parameter means that because  $T_J$  must not exceed 150°C to provide reliable operation, either the supply voltage must be reduced, or  $T_A$  needs to remain low enough so that the  $T_J$  does not exceed 150°C. This condition is illustrated in Figure 7-3 for various package types.

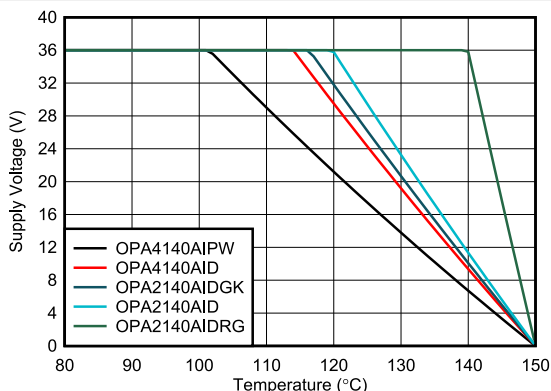

**Figure 7-3. Maximum Supply Voltage vs Temperature, Quiescent State (No Load)**

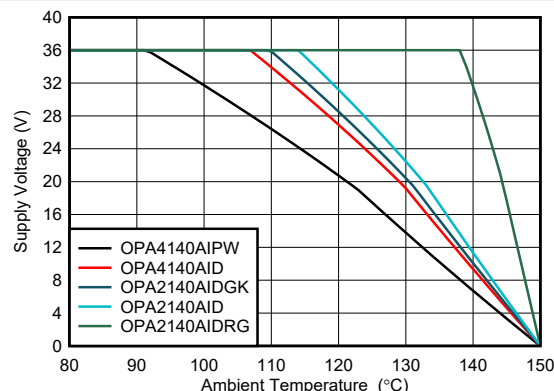

**Figure 7-4. Maximum Supply Voltage vs Temperature, DC Worst-Case**

Moreover, resistive loading of the output causes additional power dissipation and thus self-heating, which also must be considered when establishing the maximum supply voltage or operating temperature. To this end, Figure 7-4 shows the maximum supply voltage versus temperature for a 2 kΩ load resistance to mid-supply and a dc worst-case power dissipation condition. In symmetrical, bipolar supplies, the worst case dc condition is given by  $V_{OUT} = \pm V_S/4$ .

As shown by Equation 1, the junction temperature depends on the thermal properties of the package, as expressed by  $R_{\theta JA}$ . If the device then begins to drive a heavy load, the junction temperature can rise and trip the thermal-shutdown circuit. For such loading cases, the DRG package includes a thermal pad that significantly reduces  $R_{\theta JA}$ . Proper PCB layout is essential to realize this improved thermal behavior. Figure 7-3 and Figure 7-3 show the potential improvement when using the DRG package option. For more information on PCB layout best practices, see Section 8.4.1.

### 7.3.8 Electrical Overstress

Designers often ask questions about the capability of an operational amplifier to withstand electrical overstress. These questions tend to focus on the device inputs, but can involve the supply voltage pins or even the output pin. Each of these different pin functions have electrical stress limits determined by the voltage breakdown characteristics of the particular semiconductor fabrication process and specific circuits connected to the pin. Additionally, internal electrostatic discharge (ESD) protection is built into these circuits to protect them from accidental ESD events both before and during product assembly.

A good understanding of this basic ESD circuitry and the relevance to an electrical overstress event is helpful. Figure 7-5 shows an illustration of the ESD circuits contained in the OPAX140 series (indicated by the dashed line area). The ESD protection circuitry involves several current-steering diodes connected from the input and output pins and routed back to the internal power-supply lines, where the diodes meet at an absorption device internal to the operational amplifier. This protection circuitry is intended to remain inactive during normal circuit operation.

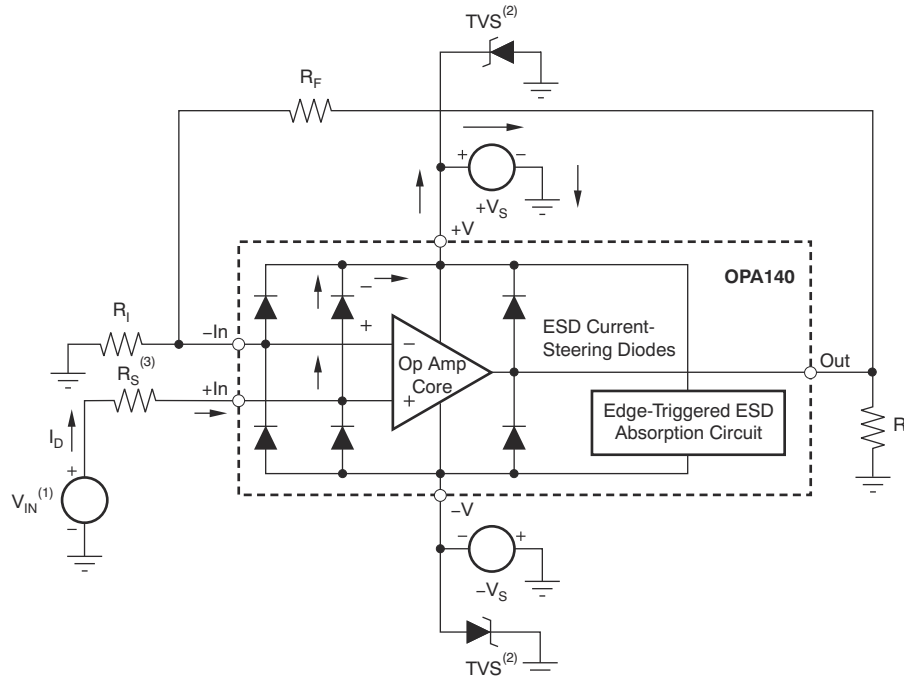

- (1)  $V_{IN} = +V_S + 500 \text{ mV}$ .
- (2) TVS:  $+V_{S(max)} > V_{TVSBR} (Min) > +V_S$
- (3) Suggested value approximately 1 kΩ.

**Figure 7-5. Equivalent Internal ESD Circuitry Relative to a Typical Circuit Application**

An ESD event produces a short duration, high-voltage pulse that is transformed into a short duration, high-current pulse when discharging through a semiconductor device. The ESD protection circuits are designed to provide a current path around the operational amplifier core to prevent damage. The energy absorbed by the protection circuitry is then dissipated as heat.

When an ESD voltage develops across two or more of the amplifier device pins, current flows through one or more of the steering diodes. Depending on the path that the current takes, the absorption device can activate. The absorption device has a trigger, or threshold voltage, that is above the normal operating voltage of the OPAx140 but below the device breakdown voltage level. When this threshold is exceeded, the absorption device quickly activates and clamps the voltage across the supply rails to a safe level.

When the operational amplifier connects into a circuit, as [Figure 7-5](#) shows, the ESD protection components are intended to remain inactive and not become involved in the application circuit operation. However, circumstances can arise where an applied voltage exceeds the operating voltage range of a given pin. If this condition occurs, there is a risk that some of the internal ESD protection circuits can be biased on and conduct current. Any such current flow occurs through steering diode paths and rarely involves the absorption device.

[Figure 7-5](#) shows a specific example where the input voltage,  $V_{IN}$ , exceeds the positive supply voltage ( $+V_S$ ) by 500 mV or more. Much of what happens in the circuit depends on the supply characteristics. If  $+V_S$  can sink the current, one of the upper input steering diodes conducts and directs current to  $+V_S$ . Excessively high current levels can flow with increasingly higher  $V_{IN}$ . As a result, the data sheet specifications recommend that applications limit the input current to 10 mA.

If the supply is not capable of sinking the current,  $V_{IN}$  can begin sourcing current to the operational amplifier, and then take over as the source of positive supply voltage. The danger in this case is that the voltage can rise to levels that exceed the operational amplifier absolute maximum ratings.

Another common question involves what happens to the amplifier if an input signal is applied to the input while the power supplies  $+V_S$  or  $-V_S$  are at 0 V. Again, the answer depends on the supply characteristic while at 0 V, or at a level below the input signal amplitude. If the supplies appear as high impedance, then the operational amplifier supply current can be supplied by the input source through the current steering diodes. This state is not a normal bias condition; the amplifier most likely does not operate normally. If the supplies are low impedance, then the current through the steering diodes can become quite high. The current level depends on the ability of the input source to deliver current, and any resistance in the input path.

If there is an uncertainty about the ability of the supply to absorb this current, external Zener diodes can be added to the supply pins; see [Figure 7-5](#). Select the Zener voltage so that the diode does not turn on during normal operation. However, the Zener voltage must be low enough so that the Zener diode conducts if the supply pin begins to exceed the safe operating supply voltage level.

### 7.3.9 EMI Rejection

The electromagnetic interference (EMI) rejection ratio, or EMIRR, describes the EMI immunity of operational amplifiers. An adverse effect that is common to many op amps is a change in the offset voltage as a result of RF signal rectification. An op amp that is more efficient at rejecting this change in offset as a result of EMI has a higher EMIRR and is quantified by a decibel value. Measuring EMIRR can be performed in many ways, but this section provides the EMIRR IN+, which specifically describes the EMIRR performance when the RF signal is applied to the noninverting input pin of the op amp. In general, only the noninverting input is tested for EMIRR for the following three reasons:

- Op amp input pins are known to be the most sensitive to EMI, and typically rectify RF signals better than the supply or output pins.
- The noninverting and inverting op amp inputs have symmetrical physical layouts and exhibit nearly matching EMIRR performance
- EMIRR is easier to measure on noninverting pins than on other pins because the noninverting input terminal can be isolated on a PCB. This isolation allows the RF signal to be applied directly to the noninverting input terminal with no complex interactions from other components or connecting PCB traces. [Figure 7-6](#)

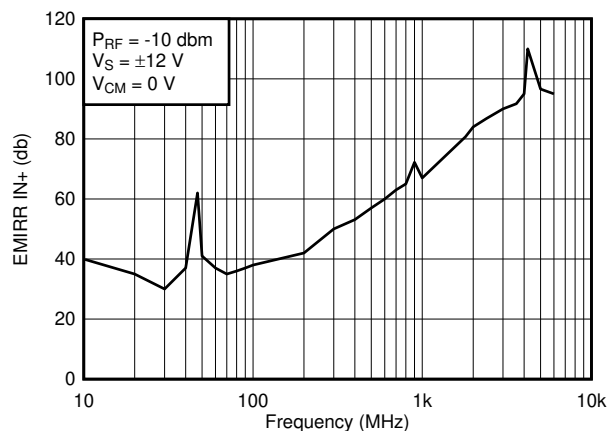

**Figure 7-6. OPA2140 EMIRR**

The EMIRR IN+ of the OPA2140 is plotted versus frequency as shown in .If available, any dual and quad op amp device versions have nearly similar EMIRR IN+ performance. The OPA2140 unity-gain bandwidth is 11 MHz. EMIRR performance below this frequency denotes interfering signals that fall within the op amp bandwidth.

For more information, see the [EMI Rejection Ratio of Operational Amplifiers Application Report](#), available for download from [www.ti.com](http://www.ti.com).

Table 7-1 lists the EMIRR IN+ values for the OPA2140 at particular frequencies commonly encountered in real-world applications. Applications listed in Table 7-1 can be centered on or operated near the particular frequency shown. This information can be of special interest to designers working with these types of applications, or working in other fields likely to encounter RF interference from broad sources, such as the industrial, scientific, and medical (ISM) radio band.

**Table 7-1. OPA2140 EMIRR IN+ for Frequencies of Interest**

FREQUENCY	APPLICATION OR ALLOCATION	EMIRR IN+
400 MHz	Mobile radio, mobile satellite, space operation, weather, radar, ultra-high frequency (UHF) applications	53.1 dB
900 MHz	Global system for mobile communications (GSM) applications, radio communication, navigation, GPS (to 1.6 GHz), GSM, aeronautical mobile, UHF applications	72.2 dB
1.8 GHz	GSM applications, mobile personal communications, broadband, satellite, L-band (1 GHz to 2 GHz)	80.7 dB
2.4 GHz	802.11b, 802.11g, 802.11n, Bluetooth®, mobile personal communications, industrial, scientific and medical (ISM) radio band, amateur radio and satellite, S-band (2 GHz to 4 GHz)	86.8 dB
3.6 GHz	Radiolocation, aero communication and navigation, satellite, mobile, S-band	91.7 dB
5 GHz	802.11a, 802.11n, aero communication and navigation, mobile communication, space and satellite operation, C-band (4 GHz to 8 GHz)	96.6 dB

### 7.3.10 EMIRR +IN Test Configuration

Figure 7-7 shows the circuit configuration for testing the EMIRR IN+. An RF source is connected to the op amp noninverting input terminal using a transmission line. The op amp is configured in a unity gain buffer topology with the output connected to a low-pass filter (LPF) and a digital multimeter (DMM). A large impedance mismatch at the op amp input causes a voltage reflection; however, this effect is characterized and accounted for when determining the EMIRR IN+. The resulting DC offset voltage is sampled and measured by the multimeter. The LPF isolates the multimeter from residual RF signals that can interfere with multimeter accuracy.

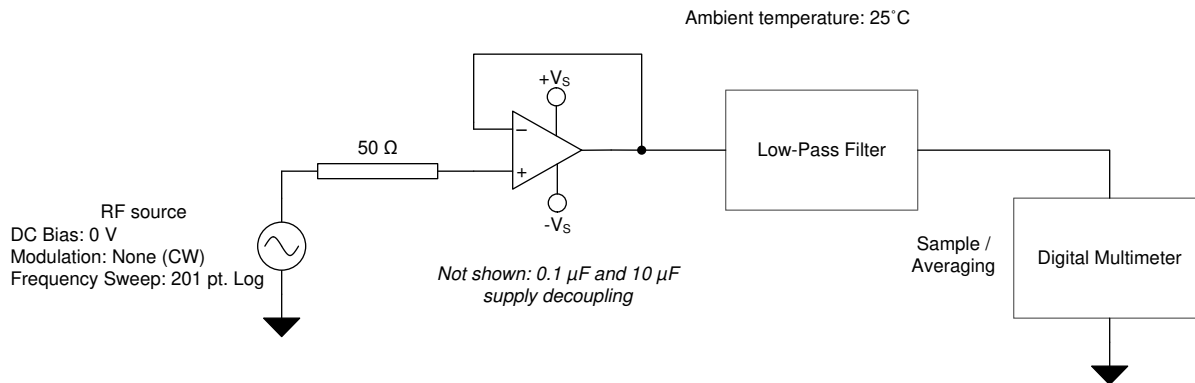

**Figure 7-7. EMIRR +IN Test Configuration**

### 7.4 Device Functional Modes

The OPAx140 has a single functional mode and is operational when the power-supply voltage is greater than 4.5 V (±2.25 V). The maximum power supply voltage for the OPAx140 is 36 V (±18 V).

## 8 Application and Implementation

### Note

Information in the following applications sections is not part of the TI component specification, and TI does not warrant its accuracy or completeness. TI's customers are responsible for determining suitability of components for their purposes, as well as validating and testing their design implementation to confirm system functionality.

### 8.1 Application Information

The OPA140, OPA2140, and OPA4140 are unity-gain stable, operational amplifiers with very low noise, input bias current, and input offset voltage. Applications with noisy or high-impedance power supplies require decoupling capacitors placed close to the device pins. In most cases, 0.1- $\mu$ F capacitors are adequate. Designers can easily use the rail-to-rail output swing and input range that includes  $V_-$  to take advantage of the low-noise characteristics of JFET amplifiers while also interfacing to modern, single-supply, precision data converters.

### 8.2 Typical Application

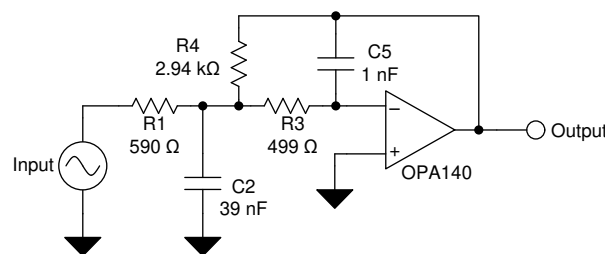

Copyright © 2016, Texas Instruments Incorporated

**Figure 8-1. 25-kHz Low-pass Filter**

#### 8.2.1 Design Requirements

Low-pass filters are commonly employed in signal processing applications to reduce noise and prevent aliasing. The OPAx140 are an excellent choice to construct high-speed, high-precision active filters. [Figure 8-1](#) shows a second-order, low-pass filter commonly encountered in signal processing applications.

Use the following parameters for this design example:

- Gain = 5 V/V (inverting gain)
- Low-pass cutoff frequency = 25 kHz
- Second-order Chebyshev filter response with 3-dB gain peaking in the pass band

#### 8.2.2 Detailed Design Procedure

The infinite-gain multiple-feedback circuit for a low-pass network function is shown in. Use [Equation 2](#) to calculate the voltage transfer function.

$$\frac{\text{Output}}{\text{Input}}(s) = \frac{-1/R_1 R_3 C_2 C_5}{s^2 + (s/C_2)(1/R_1 + 1/R_3 + 1/R_4) + 1/R_3 R_4 C_2 C_5} \quad (2)$$

This circuit produces a signal inversion. For this circuit, the gain at DC and the low-pass cutoff frequency are calculated by [Equation 3](#):

$$\text{Gain} = \frac{R_4}{R_1}$$

$$f_c = \frac{1}{2\pi} \sqrt{(1/R_3 R_4 C_2 C_5)} \quad (3)$$

Software tools are readily available to simplify filter design. The [WEBENCH® Filter Designer](#) is a simple, powerful, and easy-to-use active filter design program. The WEBENCH® Filter Designer lets you create optimized filter designs using a selection of TI operational amplifiers and passive components from TI's vendor partners.

Available as a web based tool from the WEBENCH Design Center, the WEBENCH Filter Designer allows you to design, optimize, and simulate complete, multistage, active-filter solutions within minutes.

### 8.2.3 Application Curve

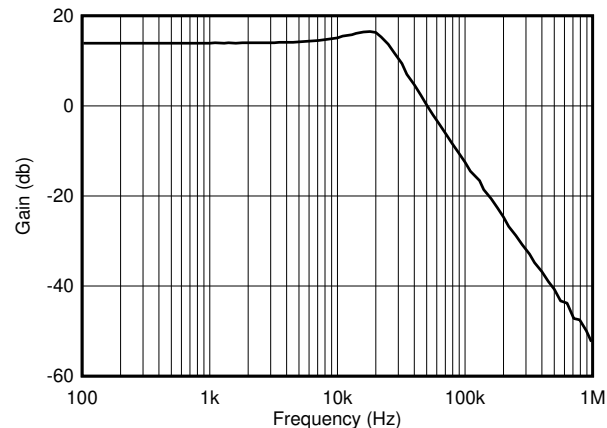

Figure 8-2. OPAx140 Second-Order, 25-kHz, Chebyshev, Low-Pass Filter

## 8.3 Power Supply Recommendations

The OPAx140 is specified for operation from 4.5 V to 36 V ( $\pm 2.25$  V to  $\pm 18$  V); many specifications apply from  $-40^{\circ}\text{C}$  to  $125^{\circ}\text{C}$ . Parameters that can exhibit significant variance with regard to operating voltage or temperature are presented in [Section 6.8](#).

### CAUTION

Supply voltages larger than 40 V can permanently damage the device; see [Section 6.1](#).

Place 0.1- $\mu\text{F}$  bypass capacitors close to the power-supply pins to reduce errors coupling in from noisy or high-impedance power supplies. For more detailed information on bypass capacitor placement, see [Section 8.4](#).

## 8.4 Layout

### 8.4.1 Layout Guidelines

For best operational performance of the device, use good PCB layout practices, including:

- Noise can propagate into analog circuitry through the power pins of the circuit as a whole and op amp itself. Bypass capacitors are used to reduce the coupled noise by providing low-impedance power sources local to the analog circuitry.
  - Connect low-ESR, 0.1- $\mu\text{F}$  ceramic bypass capacitors between each supply pin and ground, placed as close to the device as possible. A single bypass capacitor from V+ to ground is applicable for single-supply applications.
- Separate grounding for analog and digital portions of circuitry is one of the simplest and most-effective methods of noise suppression. One or more layers on multilayer PCBs are usually devoted to ground planes. A ground plane helps distribute heat and reduces EMI noise pickup. Make sure to physically separate digital and analog grounds paying attention to the flow of the ground current. For more detailed information, see [Circuit Board Layout Techniques](#).

- To reduce parasitic coupling, run the input traces as far away from the supply or output traces as possible. If these traces cannot be kept separate, crossing the sensitive trace perpendicular is much better as opposed to in parallel with the noisy trace.
- Place the external components as close to the device as possible. As illustrated in [Figure 8-3](#), keeping RF and RG close to the inverting input minimizes parasitic capacitance.
- Keep the length of input traces as short as possible. Always remember that the input traces are the most sensitive part of the circuit.
- Consider a driven, low-impedance guard ring around the critical traces. A guard ring can significantly reduce leakage currents from nearby traces that are at different potentials.
- For best performance, TI recommends cleaning the PCB following board assembly.
- Any precision integrated circuit can experience performance shifts due to moisture ingress into the plastic package. Following any aqueous PCB cleaning process, TI recommends baking the PCB assembly to remove moisture introduced into the device packaging during the cleaning process. A low temperature, post cleaning bake at 85°C for 30 minutes is sufficient for most circumstances.

In addition, follow these steps for the DRG package:

- Solder the thermal pad to a V– plane to conduct heat away from the package. Thermal vias underneath the thermal pad are recommended, but not required. The recommended pattern is shown in the mechanical drawing appended to the end of this document. If using thermal vias connect to the V– plane.
- When connecting these vias to the plane, do not use the typical web or spoke via connection methodology. Web connections have a high thermal resistance connection that is useful for slowing the heat transfer during soldering operations, making the soldering of vias that have plane connections easier. In this application, however, low thermal resistance is desired for the most efficient heat transfer. Therefore, the vias under the package must make the connections to the internal plane with a complete connection around the entire circumference of the plated-through hole.
- The top-side solder mask must leave the pins of the package and the thermal pad area exposed. The bottom-side solder mask must cover the vias of the thermal pad area. This masking prevents solder from being pulled away from the thermal pad area during the reflow process.
- Apply solder paste to the exposed thermal pad area and all of the device pins.
- With these preparatory steps in place, simply place the device in position, and run through the solder reflow operation as with any standard surface-mount component

### 8.4.2 Layout Example

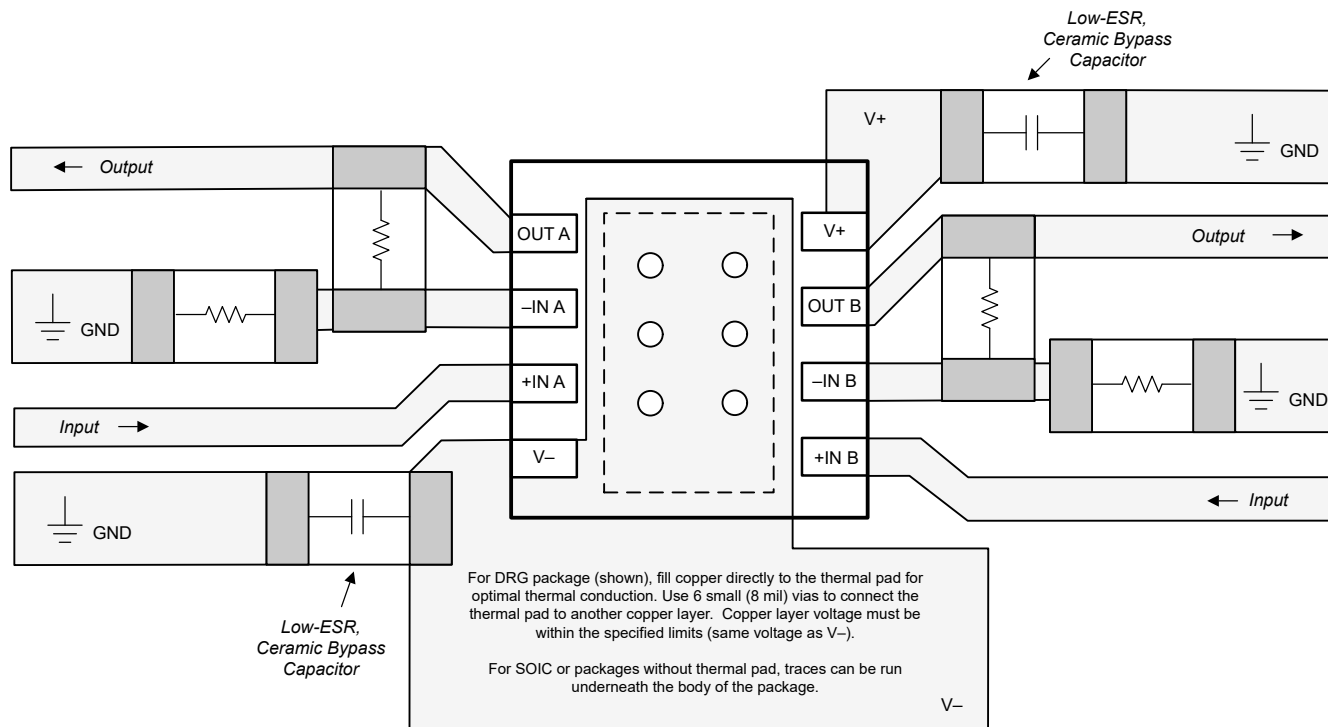

**Figure 8-3. Dual Operational Amplifier Board Layout for Noninverting Configuration**

## 9 Device and Documentation Support

### 9.1 Device Support

#### 9.1.1 Development Support

##### 9.1.1.1 PSpice® for TI

PSpice® for TI is a design and simulation environment that helps evaluate performance of analog circuits. Create subsystem designs and prototype solutions before committing to layout and fabrication, reducing development cost and time to market.

##### 9.1.1.2 TINA-TI™ Simulation Software (Free Download)

TINA-TI™ simulation software is a simple, powerful, and easy-to-use circuit simulation program based on a SPICE engine. TINA-TI simulation software is a free, fully-functional version of the TINA™ software, preloaded with a library of macromodels, in addition to a range of both passive and active models. TINA-TI simulation software provides all the conventional dc, transient, and frequency domain analysis of SPICE, as well as additional design capabilities.

Available as a [free download](#) from the [Design tools and simulation](#) web page, TINA-TI simulation software offers extensive post-processing capability that allows users to format results in a variety of ways. Virtual instruments offer the ability to select input waveforms and probe circuit nodes, voltages, and waveforms, creating a dynamic quick-start tool.

---

#### Note

These files require that either the TINA software or TINA-TI software be installed. Download the free TINA-TI simulation software from the [TINA-TI™ software folder](#).

---

##### 9.1.1.3 Filter Design Tool

The [filter design tool](#) is a simple, powerful, and easy-to-use active filter design program. The filter design tool allows the user to create optimized filter designs using a selection of TI operational amplifiers and passive components from TI's vendor partners.

Available as a web-based tool from the [Design tools and simulation](#) web page, the [filter design tool](#) allows the user to design, optimize, and simulate complete multistage active filter solutions within minutes.

##### 9.1.1.4 TI Reference Designs

TI reference designs are analog solutions created by TI's precision analog applications experts. TI reference designs offer the theory of operation, component selection, simulation, complete PCB schematic and layout, bill of materials, and measured performance of many useful circuits. TI reference designs are available online at <https://www.ti.com/reference-designs>.

## 9.2 Documentation Support

### 9.2.1 Related Documentation

For related documentation see the following:

- Texas Instruments, [Circuit Board Layout Techniques](#)
- Texas Instruments, [Op Amps for Everyone](#) design reference
- Texas Instruments, [OPA140, OPA2140, OPA4140 EMI Immunity Performance](#) technical brief
- Texas Instruments, [Compensate Transimpedance Amplifiers Intuitively](#) application report
- Texas Instruments, [Operational amplifier gain stability, Part 3: AC gain-error analysis](#)
- Texas Instruments, [Operational amplifier gain stability, Part 2: DC gain-error analysis](#)
- Texas Instruments, [Using infinite-gain, MFB filter topology in fully differential active filters](#)
- Texas Instruments, [Op Amp Performance Analysis](#) application bulletin
- Texas Instruments, [Single-Supply Operation of Operational Amplifiers](#) application bulletin
- Texas Instruments, [Tuning in Amplifiers](#) application bulletin
- Texas Instruments, [Shelf-Life Evaluation of Lead-Free Component Finishes](#) application report
- Texas Instruments, [Feedback Plots Define Op Amp AC Performance](#) application bulletin
- Texas Instruments, [EMI Rejection Ratio of Operational Amplifiers Application Report](#) application report

### 9.3 Receiving Notification of Documentation Updates

To receive notification of documentation updates, navigate to the device product folder on [ti.com](#). Click on *Subscribe to updates* to register and receive a weekly digest of any product information that has changed. For change details, review the revision history included in any revised document.

### 9.4 Support Resources

[TI E2E™ support forums](#) are an engineer's go-to source for fast, verified answers and design help — straight from the experts. Search existing answers or ask your own question to get the quick design help you need.

Linked content is provided "AS IS" by the respective contributors. They do not constitute TI specifications and do not necessarily reflect TI's views; see TI's [Terms of Use](#).

### 9.5 Trademarks

TINA-TI™ and TI E2E™ are trademarks of Texas Instruments.

TINA™ is a trademark of DesignSoft, Inc.

Bluetooth® is a registered trademark of Bluetooth SIG, Inc.

WEBENCH® is a registered trademark of Texas Instruments.

PSpice® is a registered trademark of Cadence Design Systems, Inc.

All trademarks are the property of their respective owners.

### 9.6 Electrostatic Discharge Caution



This integrated circuit can be damaged by ESD. Texas Instruments recommends that all integrated circuits be handled with appropriate precautions. Failure to observe proper handling and installation procedures can cause damage.

ESD damage can range from subtle performance degradation to complete device failure. Precision integrated circuits may be more susceptible to damage because very small parametric changes could cause the device not to meet its published specifications.

### 9.7 Glossary

[TI Glossary](#) This glossary lists and explains terms, acronyms, and definitions.

## 10 Mechanical, Packaging, and Orderable Information

The following pages include mechanical, packaging, and orderable information. This information is the most current data available for the designated devices. This data is subject to change without notice and revision of this document. For browser-based versions of this data sheet, refer to the left-hand navigation.

**PACKAGING INFORMATION**

Orderable Device	Status (1)	Package Type	Package Drawing	Pins	Package Qty	Eco Plan (2)	Lead finish/ Ball material (6)	MSL Peak Temp (3)	Op Temp (°C)	Device Marking (4/5)	Samples
OPA140AID	ACTIVE	SOIC	D	8	75	RoHS & Green	NIPDAU	Level-2-260C-1 YEAR	-40 to 125	OPA140	<a href="#">Samples</a>
OPA140AIDBVR	ACTIVE	SOT-23	DBV	5	3000	RoHS & Green	NIPDAU	Level-2-260C-1 YEAR	-40 to 125	O140	<a href="#">Samples</a>
OPA140AIDBVT	ACTIVE	SOT-23	DBV	5	250	RoHS & Green	NIPDAU	Level-2-260C-1 YEAR	-40 to 125	O140	<a href="#">Samples</a>
OPA140AIDGKR	ACTIVE	VSSOP	DGK	8	2500	RoHS & Green	Call TI   NIPDAU	Level-2-260C-1 YEAR	-40 to 125	(140, O140)	<a href="#">Samples</a>
OPA140AIDGKT	ACTIVE	VSSOP	DGK	8	250	RoHS & Green	Call TI   NIPDAU	Level-2-260C-1 YEAR	-40 to 125	140	<a href="#">Samples</a>
OPA140AIDR	ACTIVE	SOIC	D	8	2500	RoHS & Green	NIPDAU	Level-2-260C-1 YEAR	-40 to 125	OPA140	<a href="#">Samples</a>
OPA2140AID	ACTIVE	SOIC	D	8	75	RoHS & Green	NIPDAU	Level-2-260C-1 YEAR	-40 to 125	O2140A	<a href="#">Samples</a>
OPA2140AIDGKR	ACTIVE	VSSOP	DGK	8	2500	RoHS & Green	Call TI   NIPDAU	Level-2-260C-1 YEAR	-40 to 125	2140	<a href="#">Samples</a>
OPA2140AIDGKT	ACTIVE	VSSOP	DGK	8	250	RoHS & Green	Call TI   NIPDAU	Level-2-260C-1 YEAR	-40 to 125	2140	<a href="#">Samples</a>
OPA2140AIDR	ACTIVE	SOIC	D	8	2500	RoHS & Green	NIPDAU	Level-2-260C-1 YEAR	-40 to 125	O2140A	<a href="#">Samples</a>
OPA2140AIDRGR	ACTIVE	SON	DRG	8	3000	RoHS & Green	NIPDAU	Level-1-260C-UNLIM	-40 to 125	O2140	<a href="#">Samples</a>
OPA2140AIDRGT	ACTIVE	SON	DRG	8	250	RoHS & Green	NIPDAU	Level-1-260C-UNLIM	-40 to 125	O2140	<a href="#">Samples</a>
OPA4140AID	ACTIVE	SOIC	D	14	50	RoHS & Green	NIPDAU	Level-3-260C-168 HR	-40 to 125	O4140A	<a href="#">Samples</a>
OPA4140AIDR	ACTIVE	SOIC	D	14	2500	RoHS & Green	NIPDAU	Level-3-260C-168 HR	-40 to 125	O4140A	<a href="#">Samples</a>
OPA4140AIPW	ACTIVE	TSSOP	PW	14	90	RoHS & Green	NIPDAU	Level-2-260C-1 YEAR	-40 to 125	O4140A	<a href="#">Samples</a>
OPA4140AIPWR	ACTIVE	TSSOP	PW	14	2000	RoHS & Green	NIPDAU	Level-2-260C-1 YEAR	-40 to 125	O4140A	<a href="#">Samples</a>

(1) The marketing status values are defined as follows:

**ACTIVE:** Product device recommended for new designs.

**LIFEBUY:** TI has announced that the device will be discontinued, and a lifetime-buy period is in effect.

**NRND:** Not recommended for new designs. Device is in production to support existing customers, but TI does not recommend using this part in a new design.

**PREVIEW:** Device has been announced but is not in production. Samples may or may not be available.

**OBSELETE:** TI has discontinued the production of the device.

(2) **RoHS:** TI defines "RoHS" to mean semiconductor products that are compliant with the current EU RoHS requirements for all 10 RoHS substances, including the requirement that RoHS substance do not exceed 0.1% by weight in homogeneous materials. Where designed to be soldered at high temperatures, "RoHS" products are suitable for use in specified lead-free processes. TI may reference these types of products as "Pb-Free".

**RoHS Exempt:** TI defines "RoHS Exempt" to mean products that contain lead but are compliant with EU RoHS pursuant to a specific EU RoHS exemption.

**Green:** TI defines "Green" to mean the content of Chlorine (Cl) and Bromine (Br) based flame retardants meet JS709B low halogen requirements of  $\leq 1000$ ppm threshold. Antimony trioxide based flame retardants must also meet the  $\leq 1000$ ppm threshold requirement.

(3) MSL, Peak Temp. - The Moisture Sensitivity Level rating according to the JEDEC industry standard classifications, and peak solder temperature.

(4) There may be additional marking, which relates to the logo, the lot trace code information, or the environmental category on the device.

(5) Multiple Device Markings will be inside parentheses. Only one Device Marking contained in parentheses and separated by a "~" will appear on a device. If a line is indented then it is a continuation of the previous line and the two combined represent the entire Device Marking for that device.

(6) Lead finish/Ball material - Orderable Devices may have multiple material finish options. Finish options are separated by a vertical ruled line. Lead finish/Ball material values may wrap to two lines if the finish value exceeds the maximum column width.

**Important Information and Disclaimer:** The information provided on this page represents TI's knowledge and belief as of the date that it is provided. TI bases its knowledge and belief on information provided by third parties, and makes no representation or warranty as to the accuracy of such information. Efforts are underway to better integrate information from third parties. TI has taken and continues to take reasonable steps to provide representative and accurate information but may not have conducted destructive testing or chemical analysis on incoming materials and chemicals. TI and TI suppliers consider certain information to be proprietary, and thus CAS numbers and other limited information may not be available for release.

In no event shall TI's liability arising out of such information exceed the total purchase price of the TI part(s) at issue in this document sold by TI to Customer on an annual basis.

## TAPE AND REEL INFORMATION

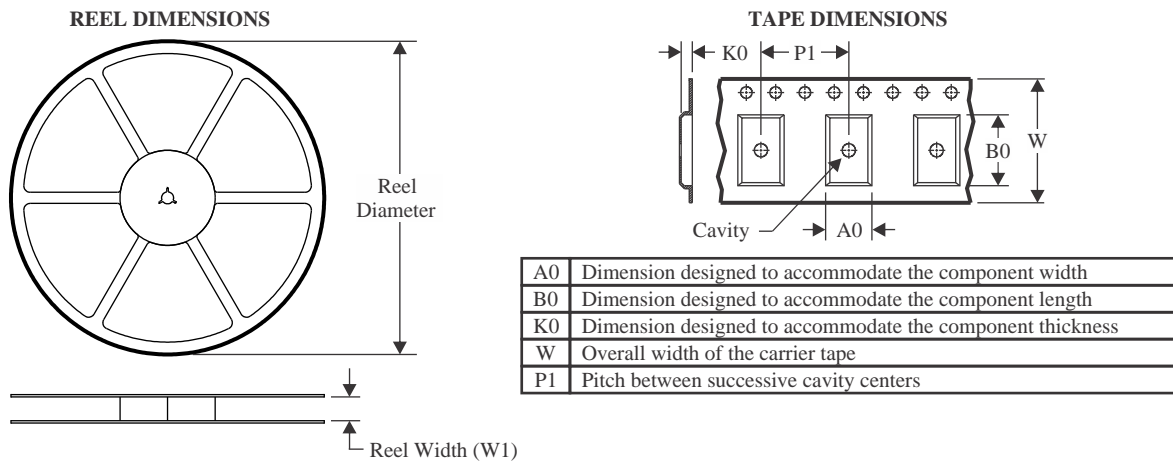

### QUADRANT ASSIGNMENTS FOR PIN 1 ORIENTATION IN TAPE

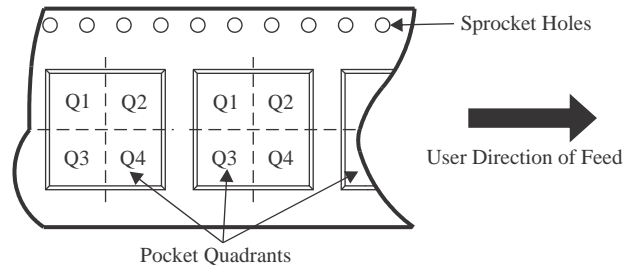

\*All dimensions are nominal

Device	Package Type	Package Drawing	Pins	SPQ	Reel Diameter (mm)	Reel Width W1 (mm)	A0 (mm)	B0 (mm)	K0 (mm)	P1 (mm)	W (mm)	Pin1 Quadrant
OPA140AIDBVR	SOT-23	DBV	5	3000	180.0	8.4	3.23	3.17	1.37	4.0	8.0	Q3
OPA140AIDBVR	SOT-23	DBV	5	3000	178.0	9.0	3.3	3.2	1.4	4.0	8.0	Q3
OPA140AIDBVT	SOT-23	DBV	5	250	180.0	8.4	3.23	3.17	1.37	4.0	8.0	Q3
OPA140AIDGKR	VSSOP	DGK	8	2500	330.0	12.4	5.3	3.4	1.4	8.0	12.0	Q1
OPA140AIDGKT	VSSOP	DGK	8	250	180.0	12.4	5.3	3.4	1.4	8.0	12.0	Q1
OPA140AIDR	SOIC	D	8	2500	330.0	12.4	6.4	5.2	2.1	8.0	12.0	Q1
OPA2140AIDGKR	VSSOP	DGK	8	2500	330.0	12.4	5.3	3.4	1.4	8.0	12.0	Q1
OPA2140AIDGKT	VSSOP	DGK	8	250	180.0	12.4	5.3	3.4	1.4	8.0	12.0	Q1
OPA2140AIDR	SOIC	D	8	2500	330.0	12.4	6.4	5.2	2.1	8.0	12.0	Q1
OPA2140AIDRGR	SON	DRG	8	3000	330.0	12.4	3.3	3.3	1.1	8.0	12.0	Q2
OPA2140AIDRGT	SON	DRG	8	250	180.0	12.4	3.3	3.3	1.1	8.0	12.0	Q2
OPA4140AIDR	SOIC	D	14	2500	330.0	16.4	6.5	9.0	2.1	8.0	16.0	Q1
OPA4140AIPWR	TSSOP	PW	14	2000	330.0	12.4	6.9	5.6	1.6	8.0	12.0	Q1

**TAPE AND REEL BOX DIMENSIONS**

\*All dimensions are nominal

Device	Package Type	Package Drawing	Pins	SPQ	Length (mm)	Width (mm)	Height (mm)
OPA140AIDBVR	SOT-23	DBV	5	3000	202.0	201.0	28.0
OPA140AIDBVR	SOT-23	DBV	5	3000	190.0	190.0	30.0
OPA140AIDBVT	SOT-23	DBV	5	250	202.0	201.0	28.0
OPA140AIDGKR	VSSOP	DGK	8	2500	356.0	356.0	35.0
OPA140AIDGKT	VSSOP	DGK	8	250	210.0	185.0	35.0
OPA140AIDR	SOIC	D	8	2500	356.0	356.0	35.0
OPA2140AIDGKR	VSSOP	DGK	8	2500	356.0	356.0	35.0
OPA2140AIDGKT	VSSOP	DGK	8	250	210.0	185.0	35.0
OPA2140AIDR	SOIC	D	8	2500	356.0	356.0	35.0
OPA2140AIDRGR	SON	DRG	8	3000	367.0	367.0	35.0
OPA2140AIDRGT	SON	DRG	8	250	210.0	185.0	35.0
OPA4140AIDR	SOIC	D	14	2500	356.0	356.0	35.0
OPA4140AIPWR	TSSOP	PW	14	2000	356.0	356.0	35.0

**TUBE**

\*All dimensions are nominal

Device	Package Name	Package Type	Pins	SPQ	L (mm)	W (mm)	T (μm)	B (mm)
OPA140AID	D	SOIC	8	75	506.6	8	3940	4.32
OPA2140AID	D	SOIC	8	75	506.6	8	3940	4.32
OPA4140AID	D	SOIC	14	50	506.6	8	3940	4.32
OPA4140AIPW	PW	TSSOP	14	90	508	8.5	3250	2.8

DGK0008A



# PACKAGE OUTLINE

VSSOP - 1.1 mm max height

SMALL OUTLINE PACKAGE



4214862/A 04/2023

NOTES:

PowerPAD is a trademark of Texas Instruments.

- 1. All linear dimensions are in millimeters. Any dimensions in parenthesis are for reference only. Dimensioning and tolerancing per ASME Y14.5M.
- 2. This drawing is subject to change without notice.
- 3. This dimension does not include mold flash, protrusions, or gate burrs. Mold flash, protrusions, or gate burrs shall not exceed 0.15 mm per side.
- 4. This dimension does not include interlead flash. Interlead flash shall not exceed 0.25 mm per side.
- 5. Reference JEDEC registration MO-187.

# EXAMPLE BOARD LAYOUT

DGK0008A

™ VSSOP - 1.1 mm max height

SMALL OUTLINE PACKAGE



LAND PATTERN EXAMPLE  
EXPOSED METAL SHOWN  
SCALE: 15X



4214862/A 04/2023

NOTES: (continued)

6. Publication IPC-7351 may have alternate designs.
7. Solder mask tolerances between and around signal pads can vary based on board fabrication site.
8. Vias are optional depending on application, refer to device data sheet. If any vias are implemented, refer to their locations shown on this view. It is recommended that vias under paste be filled, plugged or tented.
9. Size of metal pad may vary due to creepage requirement.

# EXAMPLE STENCIL DESIGN

DGK0008A

<sup>TM</sup> VSSOP - 1.1 mm max height

SMALL OUTLINE PACKAGE



SOLDER PASTE EXAMPLE  
SCALE: 15X

4214862/A 04/2023

NOTES: (continued)

11. Laser cutting apertures with trapezoidal walls and rounded corners may offer better paste release. IPC-7525 may have alternate design recommendations.
12. Board assembly site may have different recommendations for stencil design.

# DBV0005A



# PACKAGE OUTLINE

SOT-23 - 1.45 mm max height

SMALL OUTLINE TRANSISTOR

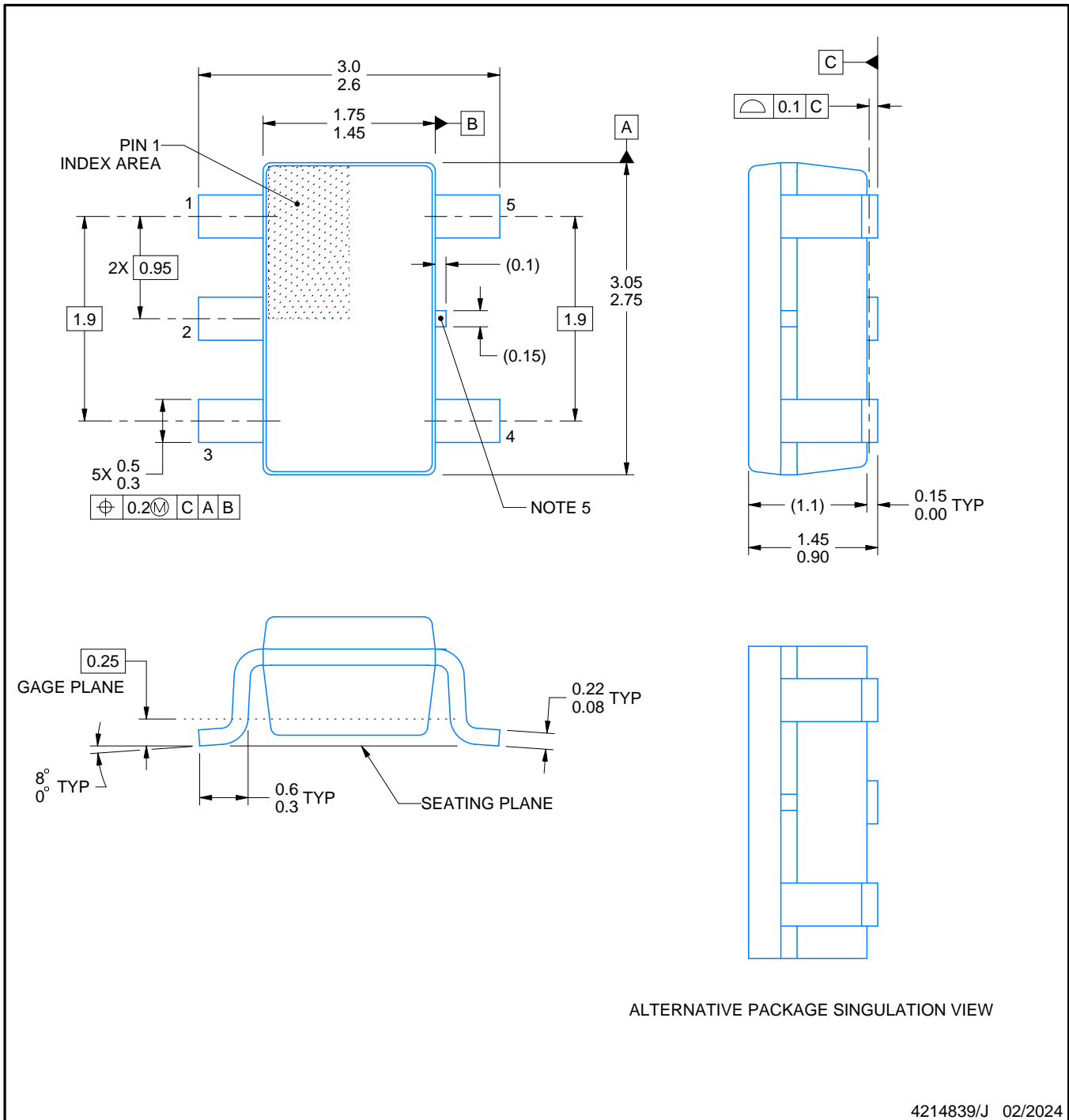

4214839/J 02/2024

### NOTES:

1. All linear dimensions are in millimeters. Any dimensions in parenthesis are for reference only. Dimensioning and tolerancing per ASME Y14.5M.
2. This drawing is subject to change without notice.
3. Reference JEDEC MO-178.
4. Body dimensions do not include mold flash, protrusions, or gate burrs. Mold flash, protrusions, or gate burrs shall not exceed 0.25 mm per side.
5. Support pin may differ or may not be present.

# EXAMPLE BOARD LAYOUT

DBV0005A

SOT-23 - 1.45 mm max height

SMALL OUTLINE TRANSISTOR



LAND PATTERN EXAMPLE  
EXPOSED METAL SHOWN  
SCALE:15X

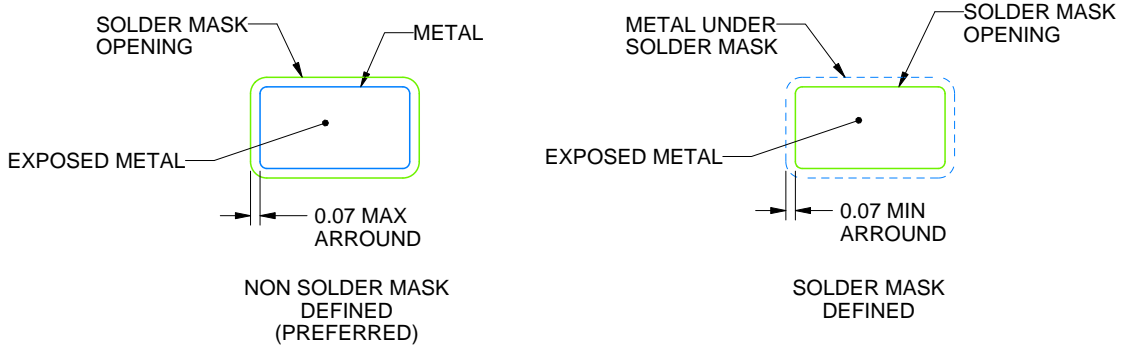

SOLDER MASK DETAILS

4214839/J 02/2024

NOTES: (continued)

- 6. Publication IPC-7351 may have alternate designs.
- 7. Solder mask tolerances between and around signal pads can vary based on board fabrication site.

# EXAMPLE STENCIL DESIGN

DBV0005A

SOT-23 - 1.45 mm max height

SMALL OUTLINE TRANSISTOR



SOLDER PASTE EXAMPLE  
BASED ON 0.125 mm THICK STENCIL  
SCALE:15X

4214839/J 02/2024

NOTES: (continued)

8. Laser cutting apertures with trapezoidal walls and rounded corners may offer better paste release. IPC-7525 may have alternate design recommendations.
9. Board assembly site may have different recommendations for stencil design.

D (R-PDSO-G14)

PLASTIC SMALL OUTLINE

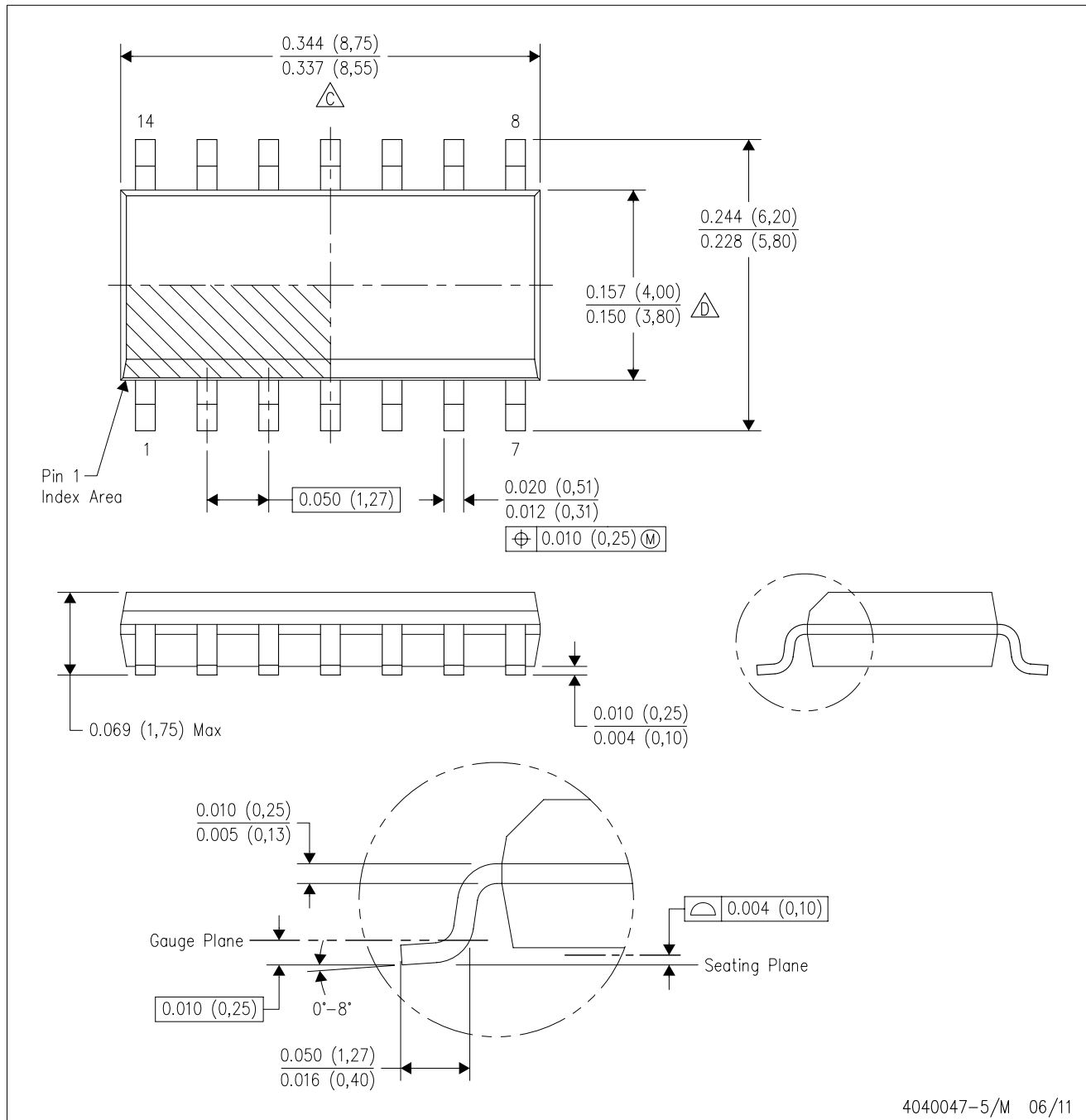

- NOTES:
- All linear dimensions are in inches (millimeters).
  - This drawing is subject to change without notice.
  - $\triangle C$  Body length does not include mold flash, protrusions, or gate burrs. Mold flash, protrusions, or gate burrs shall not exceed 0.006 (0,15) each side.
  - $\triangle D$  Body width does not include interlead flash. Interlead flash shall not exceed 0.017 (0,43) each side.
  - Reference JEDEC MS-012 variation AB.

D (R-PDSO-G14)

PLASTIC SMALL OUTLINE



4211283-3/E 08/12

- NOTES:
- All linear dimensions are in millimeters.
  - This drawing is subject to change without notice.
  - Publication IPC-7351 is recommended for alternate designs.
  - Laser cutting apertures with trapezoidal walls and also rounding corners will offer better paste release. Customers should contact their board assembly site for stencil design recommendations. Refer to IPC-7525 for other stencil recommendations.
  - Customers should contact their board fabrication site for solder mask tolerances between and around signal pads.



PW (R-PDSO-G14)

PLASTIC SMALL OUTLINE



- NOTES:
- All linear dimensions are in millimeters.
  - This drawing is subject to change without notice.
  - Publication IPC-7351 is recommended for alternate designs.
  - Laser cutting apertures with trapezoidal walls and also rounding corners will offer better paste release. Customers should contact their board assembly site for stencil design recommendations. Refer to IPC-7525 for other stencil recommendations.
  - Customers should contact their board fabrication site for solder mask tolerances between and around signal pads.



D0008A

# PACKAGE OUTLINE

SOIC - 1.75 mm max height

SMALL OUTLINE INTEGRATED CIRCUIT



4214825/C 02/2019

## NOTES:

1. Linear dimensions are in inches [millimeters]. Dimensions in parenthesis are for reference only. Controlling dimensions are in inches. Dimensioning and tolerancing per ASME Y14.5M.
2. This drawing is subject to change without notice.
3. This dimension does not include mold flash, protrusions, or gate burrs. Mold flash, protrusions, or gate burrs shall not exceed  $.006$  [0.15] per side.
4. This dimension does not include interlead flash.
5. Reference JEDEC registration MS-012, variation AA.

# EXAMPLE BOARD LAYOUT

D0008A

SOIC - 1.75 mm max height

SMALL OUTLINE INTEGRATED CIRCUIT



LAND PATTERN EXAMPLE  
 EXPOSED METAL SHOWN  
 SCALE:8X



SOLDER MASK DETAILS

4214825/C 02/2019

NOTES: (continued)

6. Publication IPC-7351 may have alternate designs.

7. Solder mask tolerances between and around signal pads can vary based on board fabrication site.

# EXAMPLE STENCIL DESIGN

D0008A

SOIC - 1.75 mm max height

SMALL OUTLINE INTEGRATED CIRCUIT



SOLDER PASTE EXAMPLE  
BASED ON .005 INCH [0.125 MM] THICK STENCIL  
SCALE:8X

4214825/C 02/2019

NOTES: (continued)

8. Laser cutting apertures with trapezoidal walls and rounded corners may offer better paste release. IPC-7525 may have alternate design recommendations.
9. Board assembly site may have different recommendations for stencil design.

DRG (S-PWSON-N8)

PLASTIC SMALL OUTLINE NO-LEAD

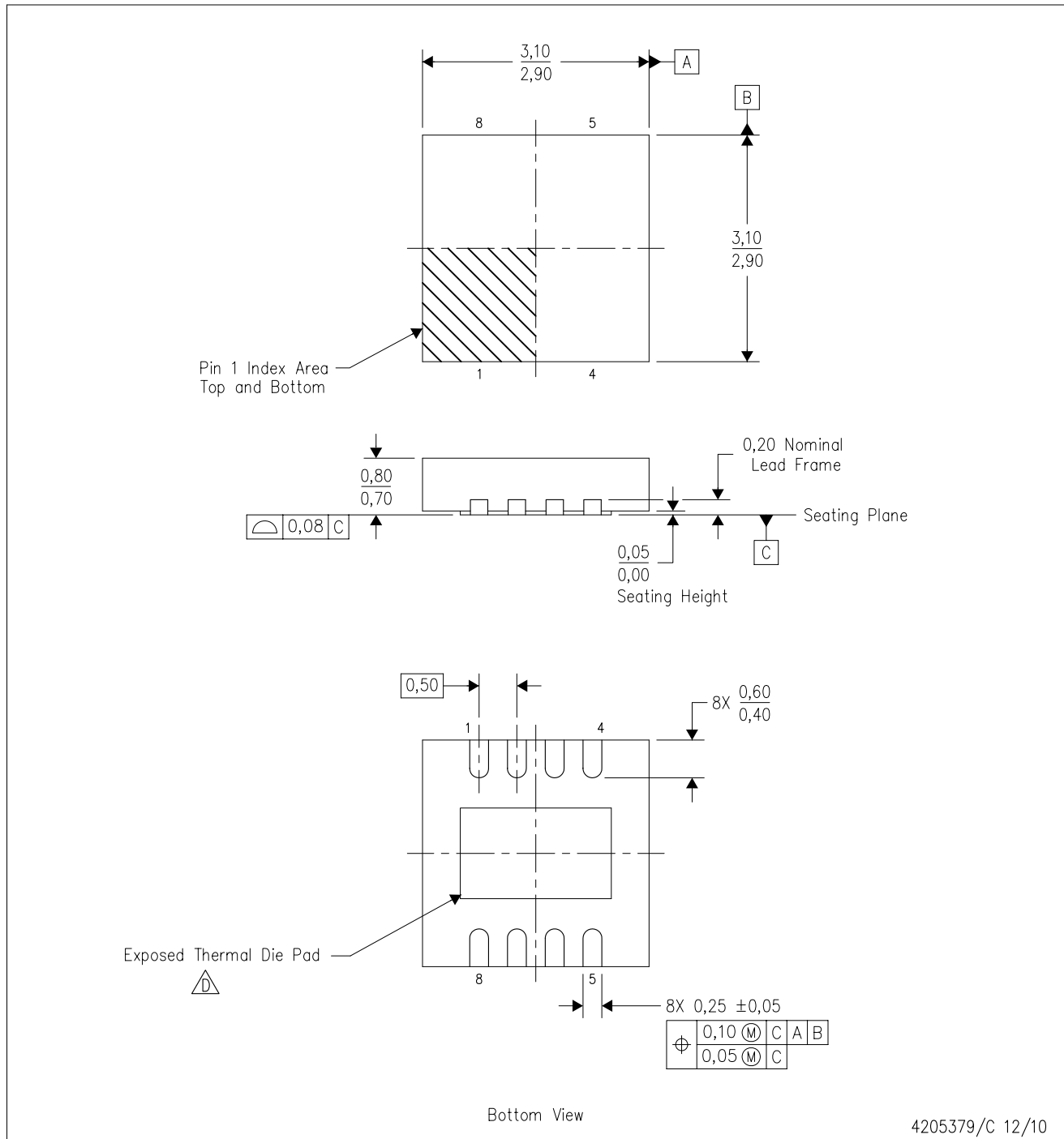

- NOTES:
- A. All linear dimensions are in millimeters. Dimensioning and tolerancing per ASME Y14.5M-1994.
  - B. This drawing is subject to change without notice.
  - C. SON (Small Outline No-Lead) package configuration.
  - D. The package thermal pad must be soldered to the board for thermal and mechanical performance. See the Product Data Sheet for details regarding the exposed thermal pad dimensions.
  - E. JEDEC MO-229 package registration pending.

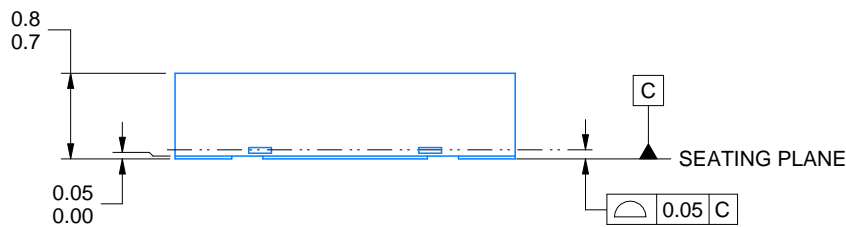
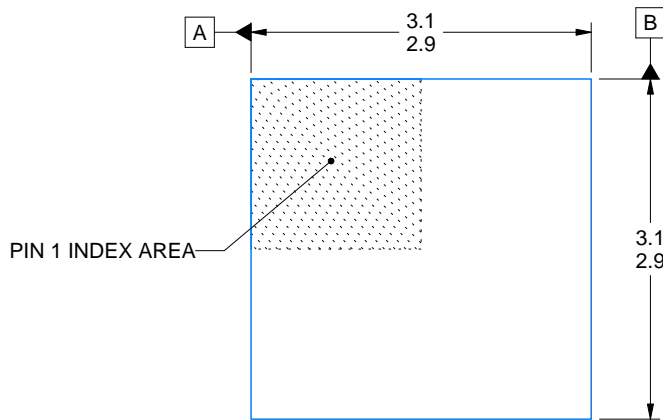
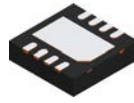

DIMENSION A	
OPTION 01	(0.1)
OPTION 02	(0.2)

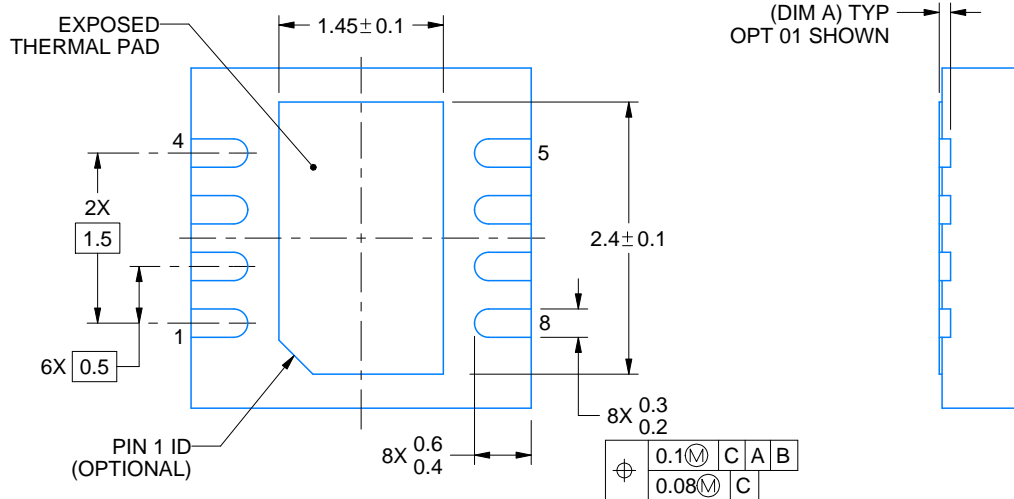

4218886/A 01/2020

NOTES:

1. All linear dimensions are in millimeters. Any dimensions in parenthesis are for reference only. Dimensioning and tolerancing per ASME Y14.5M.
2. This drawing is subject to change without notice.
3. The package thermal pad must be soldered to the printed circuit board for thermal and mechanical performance.

# EXAMPLE BOARD LAYOUT

DRG0008B

WSON - 0.8 mm max height

PLASTIC SMALL OUTLINE - NO LEAD

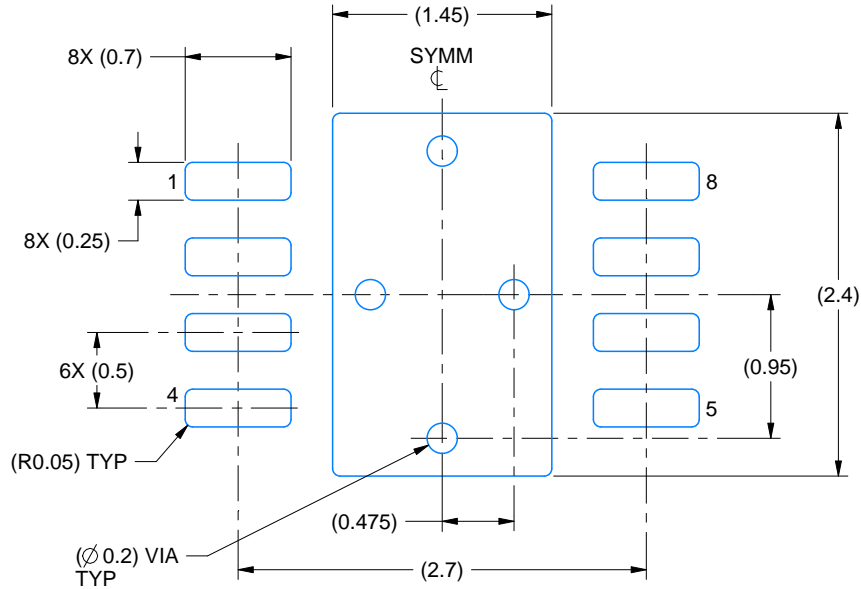

LAND PATTERN EXAMPLE  
SCALE:20X

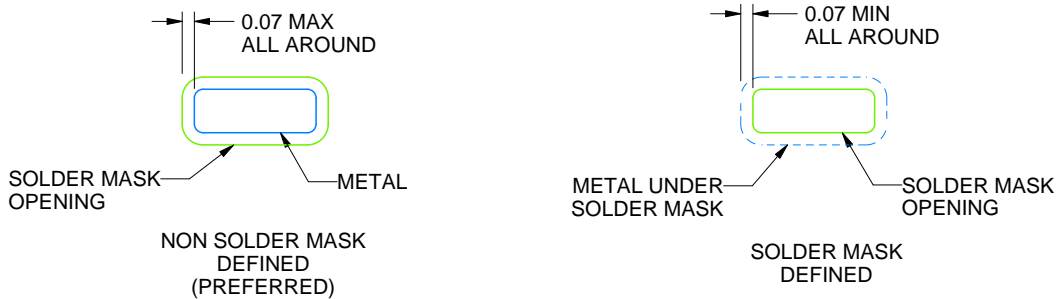

SOLDER MASK DETAILS

4218886/A 01/2020

NOTES: (continued)

- This package is designed to be soldered to a thermal pad on the board. For more information, see Texas Instruments literature number SLUA271 ([www.ti.com/lit/slua271](http://www.ti.com/lit/slua271)).
- Vias are optional depending on application, refer to device data sheet. If any vias are implemented, refer to their locations shown on this view. It is recommended that vias under paste be filled, plugged or tented.

# EXAMPLE STENCIL DESIGN

DRG0008B

WSO - 0.8 mm max height

PLASTIC SMALL OUTLINE - NO LEAD

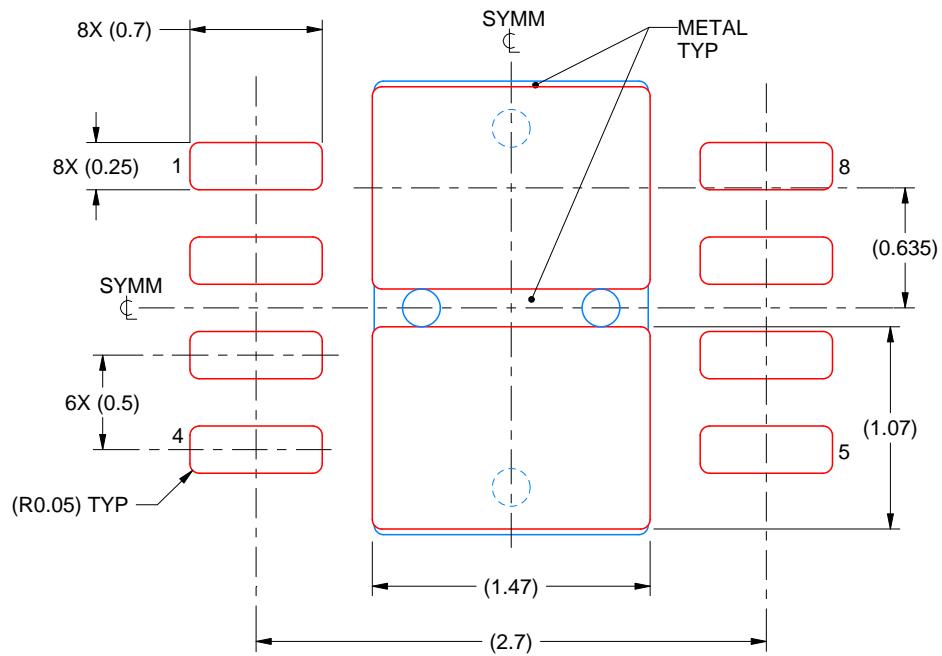

SOLDER PASTE EXAMPLE  
BASED ON 0.125 mm THICK STENCIL

EXPOSED PAD  
82% PRINTED SOLDER COVERAGE BY AREA  
SCALE:25X

4218886/A 01/2020

NOTES: (continued)

6. Laser cutting apertures with trapezoidal walls and rounded corners may offer better paste release. IPC-7525 may have alternate design recommendations.

## IMPORTANT NOTICE AND DISCLAIMER

TI PROVIDES TECHNICAL AND RELIABILITY DATA (INCLUDING DATA SHEETS), DESIGN RESOURCES (INCLUDING REFERENCE DESIGNS), APPLICATION OR OTHER DESIGN ADVICE, WEB TOOLS, SAFETY INFORMATION, AND OTHER RESOURCES "AS IS" AND WITH ALL FAULTS, AND DISCLAIMS ALL WARRANTIES, EXPRESS AND IMPLIED, INCLUDING WITHOUT LIMITATION ANY IMPLIED WARRANTIES OF MERCHANTABILITY, FITNESS FOR A PARTICULAR PURPOSE OR NON-INFRINGEMENT OF THIRD PARTY INTELLECTUAL PROPERTY RIGHTS.

These resources are intended for skilled developers designing with TI products. You are solely responsible for (1) selecting the appropriate TI products for your application, (2) designing, validating and testing your application, and (3) ensuring your application meets applicable standards, and any other safety, security, regulatory or other requirements.

These resources are subject to change without notice. TI grants you permission to use these resources only for development of an application that uses the TI products described in the resource. Other reproduction and display of these resources is prohibited. No license is granted to any other TI intellectual property right or to any third party intellectual property right. TI disclaims responsibility for, and you will fully indemnify TI and its representatives against, any claims, damages, costs, losses, and liabilities arising out of your use of these resources.

TI's products are provided subject to [TI's Terms of Sale](#) or other applicable terms available either on [ti.com](https://www.ti.com) or provided in conjunction with such TI products. TI's provision of these resources does not expand or otherwise alter TI's applicable warranties or warranty disclaimers for TI products.

TI objects to and rejects any additional or different terms you may have proposed.

Mailing Address: Texas Instruments, Post Office Box 655303, Dallas, Texas 75265  
Copyright © 2024, Texas Instruments Incorporated

## Looking for pricing, stock, or lifecycle information?

Click below to explore more details on WIN SOURCE:

 [View OPA2140AIDGKR on WIN SOURCE](#)

 [Texas Instruments](#) Information

## Optimize Your Supply Chain with WIN SOURCE Solutions

-  Global Sourcing Solution
-  Obsolete Management
-  Cost Control Management
-  Shortage Management
-  Alternative Solution
-  Excess Inventory Management