

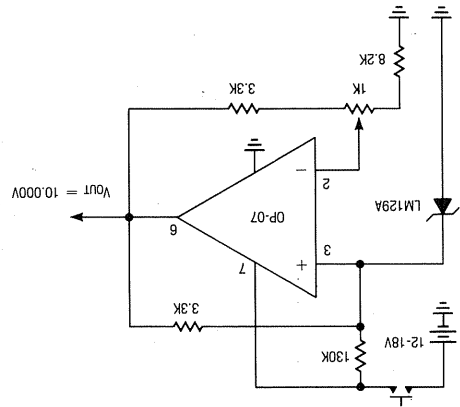

**THE DATASHEET OF  
OP07CS8#PBF**



The OP-07 contributes less than 5% of the total drift with temperature, noise and long term drift of the reference application.



**Precision Buffered Single Supply Reference**

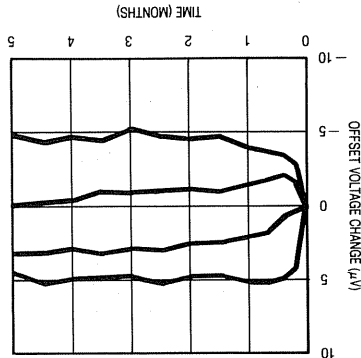

**Long Term Stability of Four Representative Units**

**APPLICATIONS**

- Thermocouple Amplifiers
- Strain Gauge Amplifiers
- Low Level Signal Processing
- Medical Instrumentation
- Guaranteed 150µV max. Offset Voltage
- Guaranteed 1.8µV/°C max. Offset Voltage Drift with Temperature
- Excellent 2.0µV/Month max. Long Term Stability
- Guaranteed 0.65µV-p-p max. Noise
- Guaranteed 7nA max. Input Bias Current

**FEATURES**

**DESCRIPTION**

The OP-07 offers excellent performance in applications requiring low offset voltage, low drift with time and temperature and very low noise. Linear's OP-07 is interchangeable with many of the precision op amp device types. The OP-07 also offers a wide input voltage range, high common-mode rejection and low input bias current. These features result in optimum performance for small signal level and low frequency applications. Use of advanced design, processing and testing techniques make Linear's OP-07 a superior choice over similar products. A buffered reference application is shown below. For single op amp applications requiring higher performance in the SO package, see the LT1001CS8.

OP-07CS8  
Precision Operational  
Amplifier

**ABSOLUTE MAXIMUM RATINGS**

Supply Voltage .....  $\pm 22V$   
 Differential Input Voltage .....  $\pm 30V$   
 Input Voltage Equal to Supply Voltage  
 Output Short Circuit Duration ..... Indefinite  
 Operating Temperature Range .....  $0^{\circ}C$  to  $70^{\circ}C$   
 Storage Temperature Range  
 All Devices .....  $-65^{\circ}C$  to  $150^{\circ}C$   
 Lead Temperature (Soldering, 10 sec.) .....  $300^{\circ}C$

**PACKAGE/ORDER INFORMATION**

TOP VIEW

S8 PACKAGE  
PLASTIC SO

ORDER PART NUMBER

OP-07CS8

---

PART MARKING

OP07CS8

**ELECTRICAL CHARACTERISTICS**  $V_S = \pm 15V, T_A = 25^{\circ}C$ , unless otherwise noted.

SYMBOL	PARAMETER	CONDITIONS	OP-07CS8			UNITS
			MIN	TYP	MAX	
$V_{OS}$	Input Offset Voltage	(Note 1)		60	150	$\mu V$
$\frac{\Delta V_{OS}}{\Delta Time}$	Long Term Input Offset Voltage Stability	(Notes 2 and 3)		0.4	2.0	$\mu V/Month$
$I_{OS}$	Input Offset Current			0.8	6.0	nA
$I_B$	Input Bias Current			$\pm 1.8$	$\pm 7.0$	nA
$e_n$	Input Noise Voltage	0.1Hz to 10Hz (Note 2)		0.35	0.65	$\mu Vp-p$
	Input Noise Voltage Density	$f_0 = 10Hz$ $f_0 = 100Hz$ (Note 2) $f_0 = 1000Hz$		10.5 10.2 9.8	20.0 13.5 11.5	$nV/\sqrt{Hz}$ $nV/\sqrt{Hz}$ $nV/\sqrt{Hz}$
$I_n$	Input Noise Current	0.1Hz to 10Hz (Note 2)		15	35	pAp-p
	Input Noise Current Density	$f_0 = 10Hz$ $f_0 = 100Hz$ (Note 2) $f_0 = 1000Hz$		0.32 0.15 0.13	0.90 0.27 0.18	$pA/\sqrt{Hz}$ $pA/\sqrt{Hz}$ $pA/\sqrt{Hz}$
$R_{in}$	Input Resistance Differential Mode	(Note 4)	8	33		M $\Omega$
	Input Resistance Common-Mode			120		G $\Omega$
	Input Voltage Range		$\pm 13.0$	$\pm 14.0$		V
CMRR	Common-Mode Rejection Ratio	$V_{CM} = \pm 13V$	100	120		dB
PSRR	Power Supply Rejection Ratio	$V_S = \pm 3V$ to $\pm 18V$	90	104		dB
$A_{VOL}$	Large Signal Voltage Gain	$R_L = 2k\Omega, V_O = \pm 10V$ $R_L = 500\Omega, V_O = \pm 0.5V$ $V_S = \pm 3V$ (Note 4)	120 100	400 400		$V/mV$ $V/mV$
$V_O$	Maximum Output Voltage Swing	$R_L = 10k\Omega$ $R_L \geq 2k\Omega$ $R_L \geq 1k\Omega$	$\pm 12.5$ $\pm 11.5$	$\pm 13.0$ $\pm 12.8$ $\pm 12.0$		V V V
SR	Slewing Rate	$R_L \geq 2k\Omega$ (Note 2)	0.1	0.25		$V/\mu s$
GBW	Closed Loop Bandwidth	$A_{VOL} = +1$ (Note 2)	0.4	0.6		MHz
$Z_o$	Open Loop Output Impedance	$V_O = 0, I_o = 0, f = 10Hz$		60		$\Omega$
$P_d$	Power Dissipation	$V_S = \pm 15V$ $V_S = \pm 3V$	80 4	150 8		mW mW
	Offset Adjustment Range	Null Pot = $20k\Omega$		$\pm 4$		mV

OP-07CS8

**ELECTRICAL CHARACTERISTICS**  $V_S = \pm 15V, 0^\circ C \leq T_A \leq 70^\circ C$ , unless otherwise noted.

SYMBOL	PARAMETER	CONDITIONS			UNITS
		MIN	TYP	MAX	
$V_{OS}$	Input Offset Voltage		85	250	$\mu V$
$\Delta V_{OS}$	Average Input Offset Voltage Drift Without External Trim	0.5	1.8		$\mu V/^\circ C$
	With External Trim		0.4	1.6	$\mu V/^\circ C$
	Null Point = 20k $\Omega$ (Note 2)				
$I_{OS}$	Input Offset Current		1.6	8.0	nA
$\Delta I_{OS}$	Average Input Offset Current Drift			12	$\mu A/^\circ C$
	(Note 2)			50	$\mu A/^\circ C$
$I_B$	Input Bias Current		$\pm 2.2$	$\pm 9.0$	nA
$\Delta I_B$	Average Input Bias Current Drift			18	$\mu A/^\circ C$
	(Note 2)			50	$\mu A/^\circ C$
CMRR	Common-Mode Rejection Ratio		$\pm 13.0$	$\pm 13.5$	dB
PSRR	Power Supply Rejection Ratio		97	120	dB
	$V_S = \pm 3V$ to $\pm 18V$		86	100	dB
$A_{VOL}$	Large Signal Voltage Gain		100	400	V/mV
$V_{out}$	Output Voltage Swing		$\pm 11.0$	$\pm 12.6$	V
	$R_L \geq 2k\Omega$				

The  $\bullet$  denotes specifications which apply over the full operating temperature range.  
 Note 1: Offset voltage is measured with high speed test equipment, approximately 1 second after power is applied.  
 Note 2: This parameter is tested on a sample basis only.

Note 3: Long Term Input Offset Voltage Stability refers to the averaged trend line of  $V_{OS}$  versus Time over extended periods after the first 30 days of operation. Excluding the initial hour of operation, changes in  $V_{OS}$  during the first 30 operating days are typically  $2.5\mu V$ .  
 Note 4: This parameter is guaranteed by design.







## Looking for pricing, stock, or lifecycle information?

Click below to explore more details on WIN SOURCE:

 [View OP07CS8#PBF](#) on WIN SOURCE

 [Linear Technology](#) Information

## Optimize Your Supply Chain with WIN SOURCE Solutions

-  Global Sourcing Solution
-  Obsolete Management
-  Cost Control Management
-  Shortage Management
-  Alternative Solution
-  Excess Inventory Management