



**THE DATASHEET OF
NUR460,133**





High Performance Axial Leaded NUR460

Product Line Bipolar Power

May, 2011

Bipolar Power Roadmap for Power Diodes

- Production
- Development
- Plan

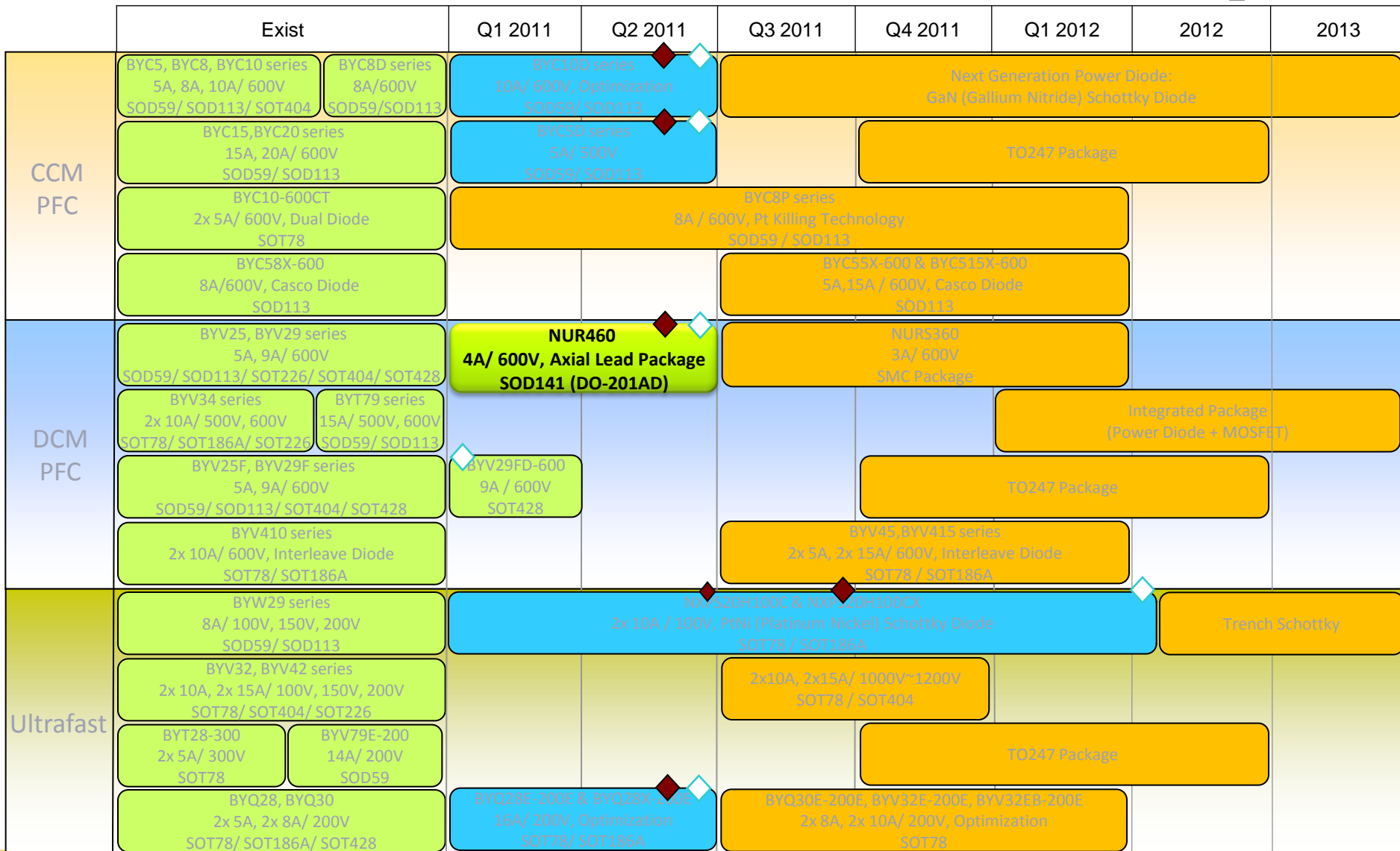

- ◆ Samples
- ◇ Production Release

Product Profile – NUR460



General Description :

- **Ultra fast epitaxial diode in a SOD141(DO201-AD) axial lead plastic package.**

Features and Benefits:

- **Fast switching,**
- **low thermal resistance**
- **Low forward voltage drop**
- **Soft recovery characteristics**

Applications:

- **High frequency switched-mode power supplies,**
- **Discontinuous mode, power factor correction**

Improved Electrical Characteristics



Low V_F leads to low on-state losses

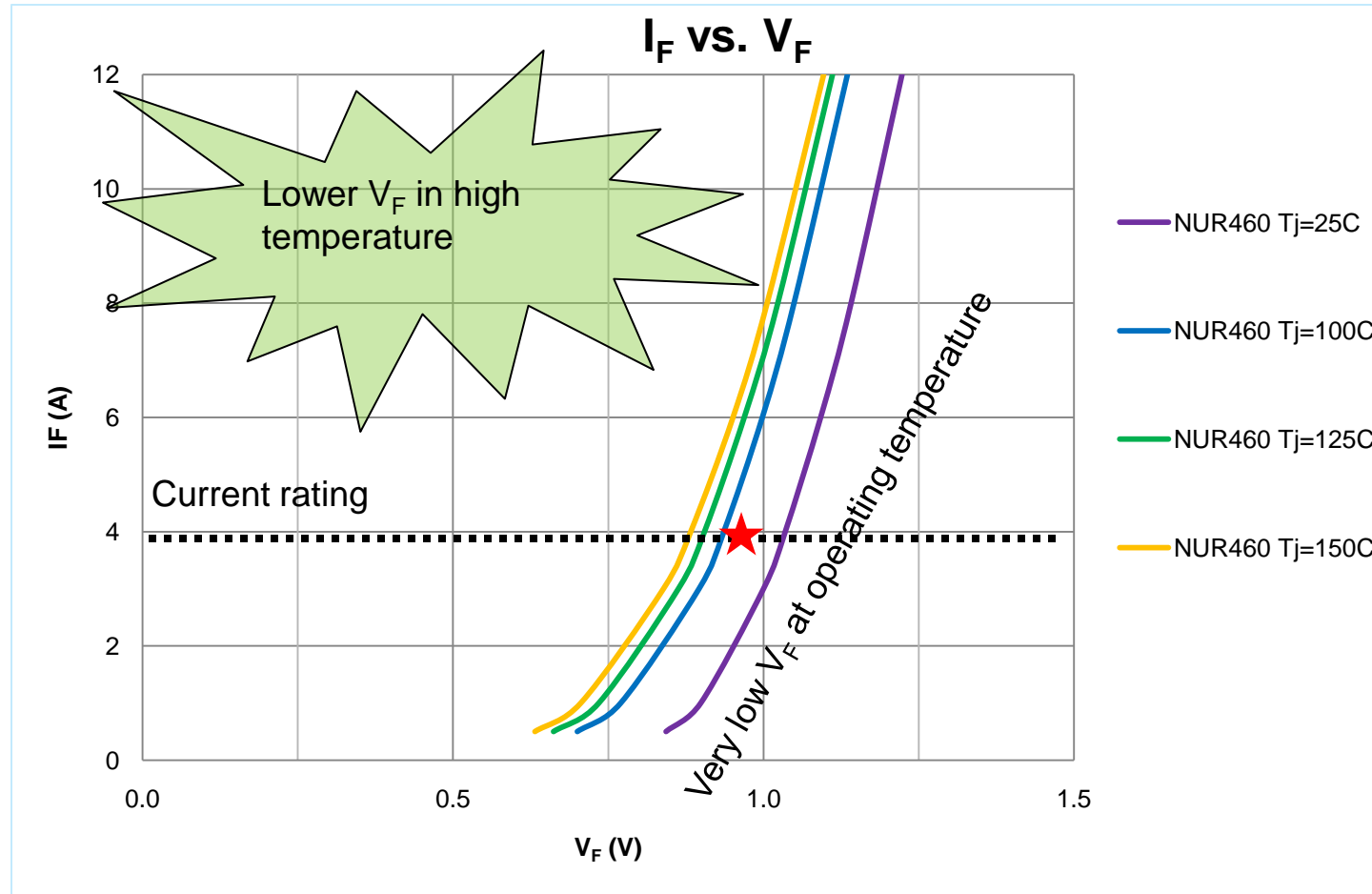

NUR460 - Soft reverse recovery and fast t_{rr}

Reverse recovery characteristic @ $I_F=1A$, $dI_F/dt=50A/us$

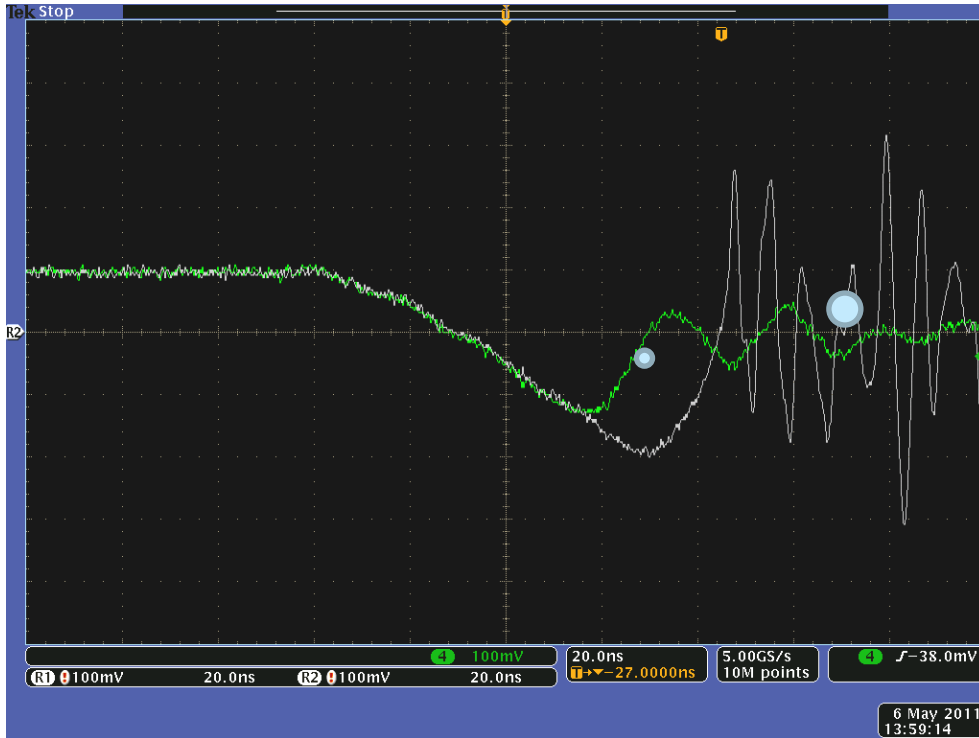

Guess which is NUR460?

- ✓ Soft reverse recovery and fast t_{rr} can benefit:
- ✓ lower switching losses
- ✓ Better EMI performance

MUR460
 $t_{rr} = 48ns$

Reduced 33%!

NUR460
 $t_{rr} = 36ns$

I_{FSM} comparison

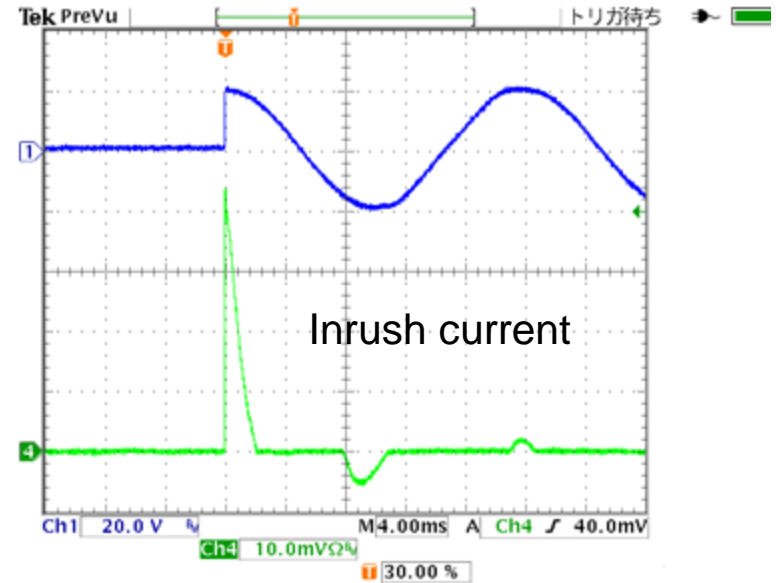
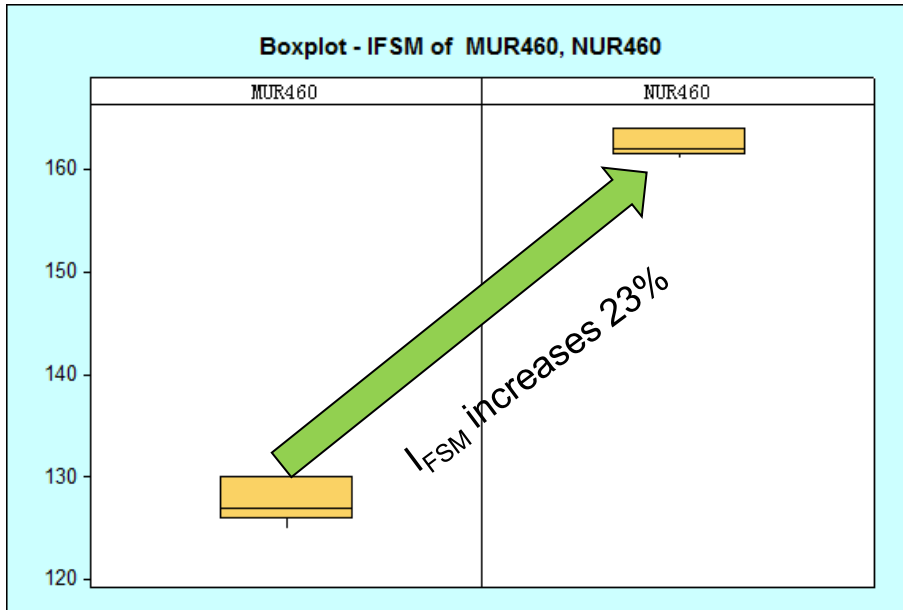

The higher I_{FSM} , the more reliability!

Outstanding Performance In Application



Typical Application- Power Factor Correction

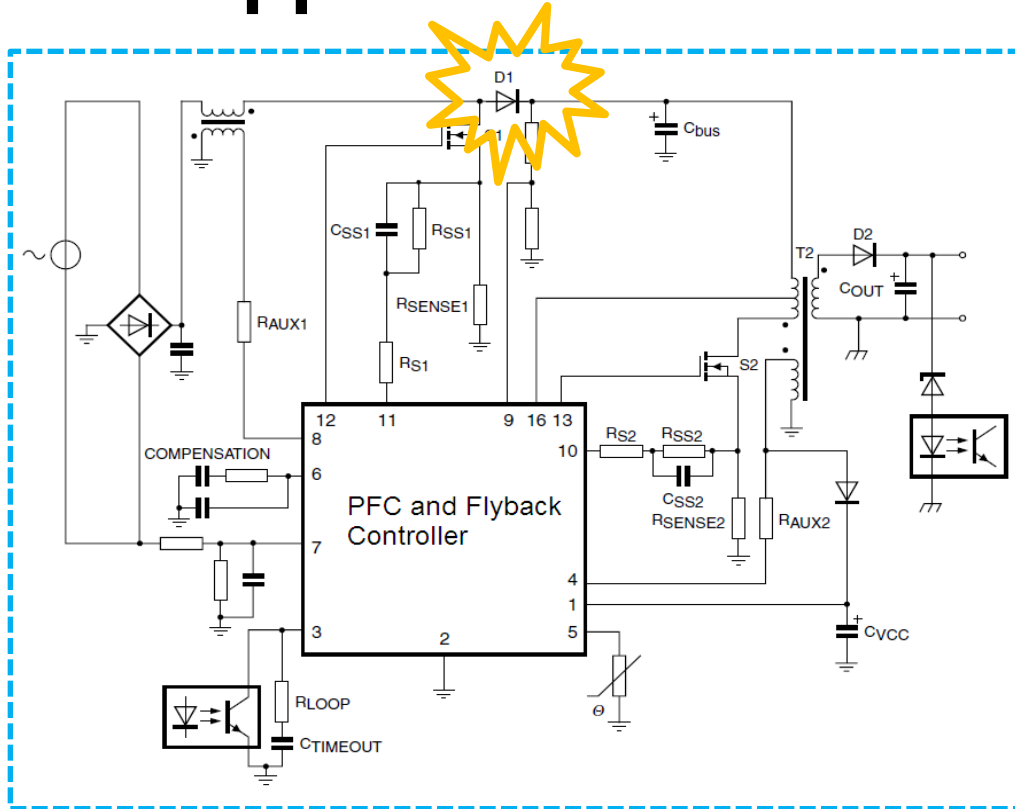

The PFC block create a 380V ~ 400V (DC) supply voltage using a high performance axial leaded NUR460 designated D1 in the circuit diagram.

Cleaner and Greener (1/2)

CH1 (Yellow)
CH2 (Blue)

voltage across D1;
current across D1;

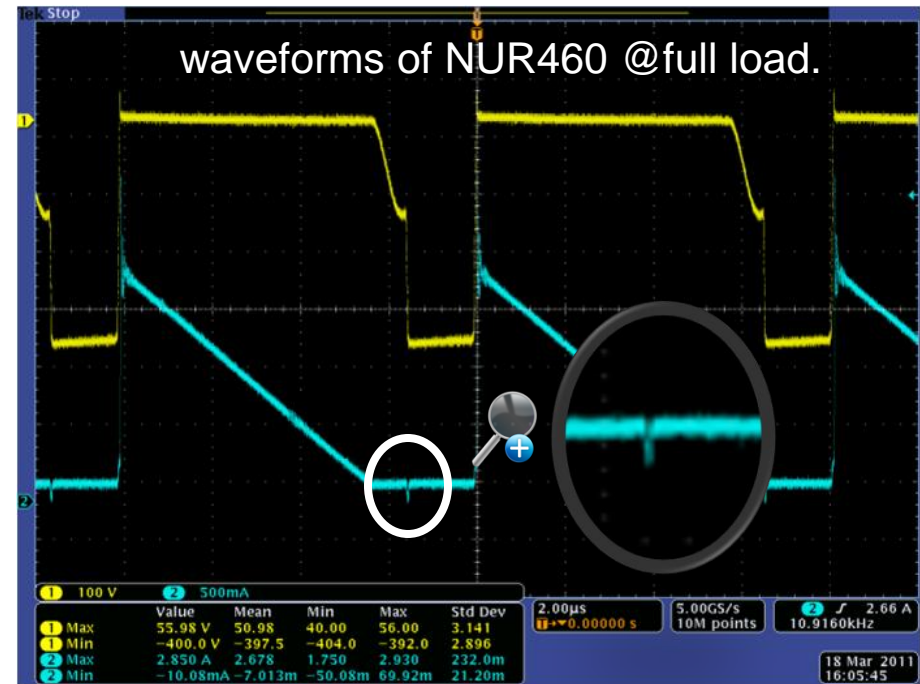
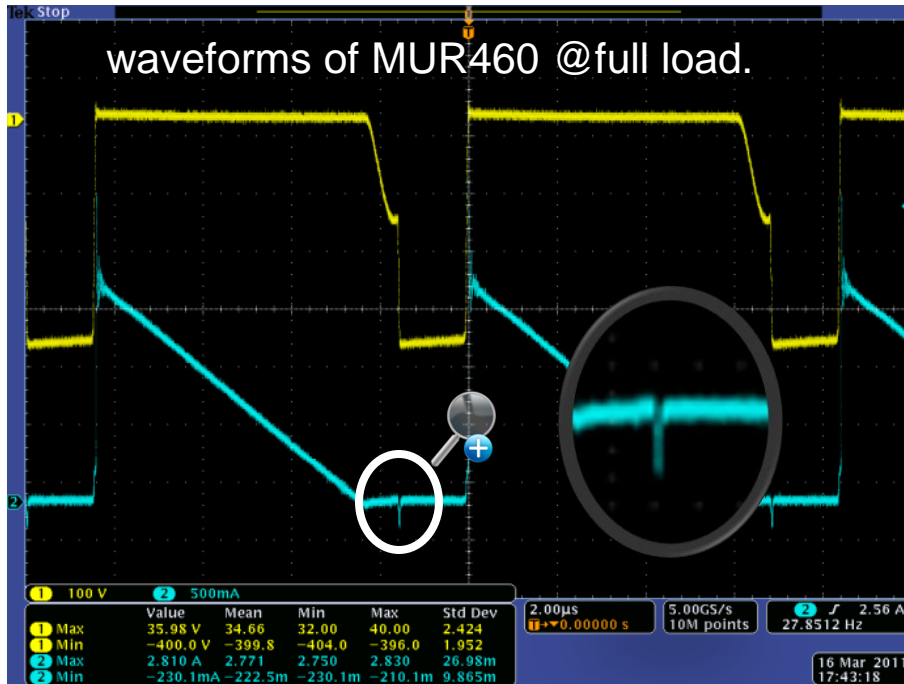

The blip in the highlighted area shows the reverse recovery current of D1 at the moment when the voltage on it rises rapidly. At this point the MOSFET voltage is still significant, and the blip in the diode current appears as an additional turn-transient in the MOSFET. Needless to say, the smaller blip of NUR460 leads to less heat dissipated into MOSFET.

Cleaner and Greener (2/2)

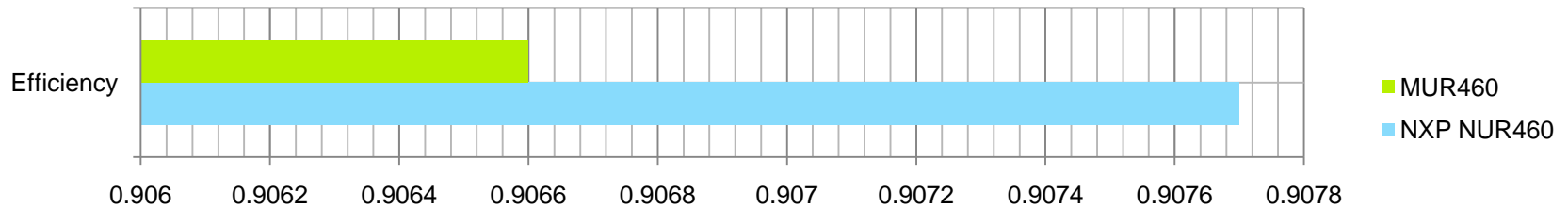
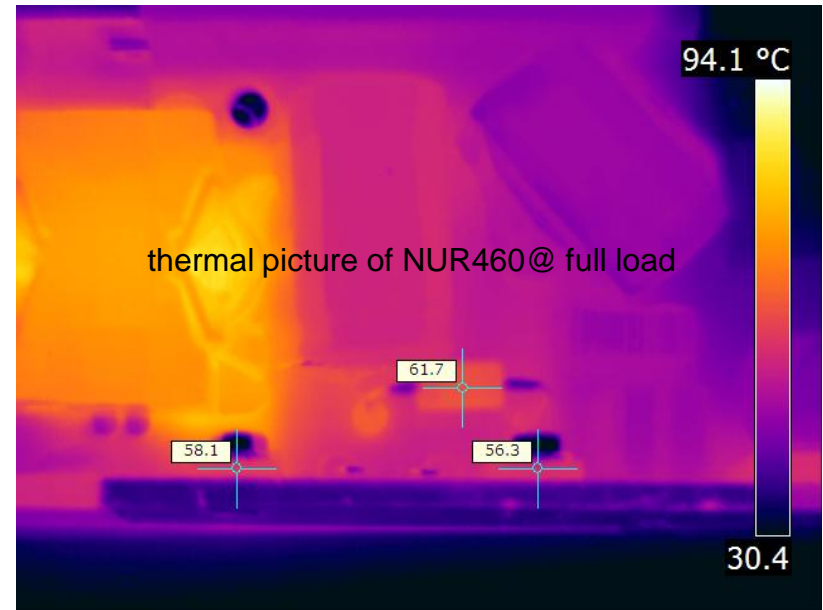
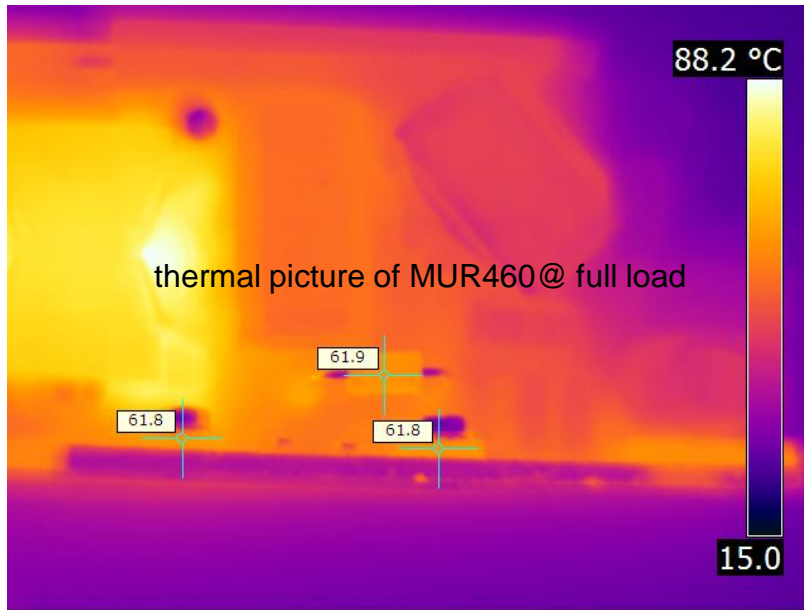

The thermal pictures indicate that temperature rises of D1 and MOSFETs S1/S2 are lower when using the NUR460 than using the MUR460. This is in accordance with the efficiency results. NUR460 is well suited for 90W active boost PFC circuit and gives better performance than that of MUR460 in terms of efficiency and temperature rise. The faster t_{rr} accounts for its better performance.

Web links

Datasheets

- http://www.nxp.com/products/diodes/power_diodes_ultrafast_recovery/index.html#ps

Selection Guide

- http://www.nxp.com/acrobat_download/literature/9397/75016163.pdf

Power bipolar / Thyristors / Power Diodes

- <http://www.nxp.com>

Cross reference tool

- <http://www.nxp.com/search/advanced/>



References materials (Power Diodes):

Leaflets - http://www.nxp.com/all_literature/index.html#dio

App notes - http://www.nxp.com/all_appnotes/71100.html

Technical support

General questions - <http://www.nxp.com/techsupport/index.php>

Specific questions - bipolar.power@nxp.com



Bipolar Power Product Selection Guide

Efficient, Reliable and Green

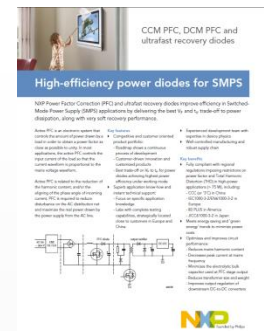

CCM PFC, DCM PFC and ultrafast recovery diodes

High-efficiency power diodes for SMPS

NXP Power Factor Correction (PFC) and ultrafast recovery diodes improve efficiency in Switch Mode Power Supply (SMPS) applications by delivering the best I_r and I_r trade-off to power designers, along with very soft-recovery performance.

- **Key benefits:**
 - Improved efficiency
 - Reduced EMI
 - Reduced heat
 - Reduced component count
 - Reduced size
 - Improved reliability
 - Improved power density
 - Improved efficiency
 - Improved power density
 - Improved efficiency
 - Improved power density
- **Key features:**
 - Ultrafast recovery
 - Low reverse recovery charge
 - Low reverse recovery time
 - Low reverse recovery current
 - Low reverse recovery voltage
 - Low reverse recovery energy
 - Low reverse recovery power
 - Low reverse recovery loss
 - Low reverse recovery temperature
 - Low reverse recovery resistance
 - Low reverse recovery inductance
 - Low reverse recovery capacitance
 - Low reverse recovery inductance
 - Low reverse recovery capacitance
- **Key applications:**
 - Power Factor Correction (PFC)
 - Ultrafast recovery diodes
 - Switch Mode Power Supply (SMPS)
 - Power MOSFETs
 - Power IGBTs
 - Power BJTs
 - Power Diodes
 - Power Thyristors
 - Power Triacs
 - Power Rectifiers
 - Power Diodes
 - Power Thyristors
 - Power Triacs
 - Power Rectifiers
- **Key specifications:**
 - Reverse recovery time
 - Reverse recovery charge
 - Reverse recovery current
 - Reverse recovery voltage
 - Reverse recovery energy
 - Reverse recovery power
 - Reverse recovery loss
 - Reverse recovery temperature
 - Reverse recovery resistance
 - Reverse recovery inductance
 - Reverse recovery capacitance



WHERE to find the information to get kick-started

Looking for pricing, stock, or lifecycle information?

Click below to explore more details on WIN SOURCE:

 [View NUR460,133 on WIN SOURCE](#)

 [NXP / Nexperia Information](#)

Optimize Your Supply Chain with WIN SOURCE Solutions

-  Global Sourcing Solution
-  Obsolete Management
-  Cost Control Management
-  Shortage Management
-  Alternative Solution
-  Excess Inventory Management