



**THE DATASHEET OF
30CTQ060-1PBF**





30CTQ060
30CTQ060S
30CTQ060 -1

SCHOTTKY RECTIFIER

30 Amp

$I_{F(AV)} = 30\text{Amp}$
 $V_R = 50 - 60\text{V}$





Major Ratings and Characteristics

Characteristics	30CTQ	Units
$I_{F(AV)}$ Rectangular waveform	30	A
V_{RRM}	50 - 60	V
I_{FSM} @ tp = 5 μ s sine	1000	A
V_F @ 15 Apk, $T_J = 125^\circ\text{C}$ (per leg)	0.56	V
T_J range	-55 to 150	$^\circ\text{C}$

Description/ Features

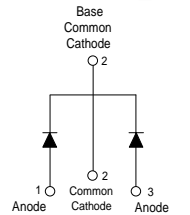
This center tap Schottky rectifier has been optimized for very low forward voltage drop, with moderate leakage. The proprietary barrier technology allows for reliable operation up to 150° C junction temperature. Typical applications are in switching power supplies, converters, free-wheeling diodes, and reverse battery protection.

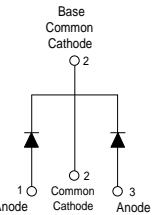
- 150° C T_J operation
- Center tap configuration
- Very low forward voltage drop
- High purity, high temperature epoxy encapsulation for enhanced mechanical strength and moisture resistance
- High frequency operation
- Guard ring for enhanced ruggedness and long term reliability

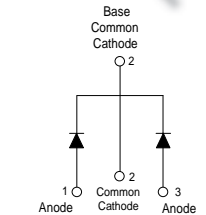
Case Styles		
<p>30CTQ...</p>   <p>TO-220</p>	<p>30CTQ... S</p>   <p>D²PAK</p>	<p>30CTQ... -1</p>   <p>TO-262</p>

Voltage Ratings

Part number	30CTQ050	30CTQ060
V_R Max. DC Reverse Voltage (V)	50	60
V_{RWM} Max. Working Peak Reverse Voltage (V)		

Absolute Maximum Ratings

Parameters	Values	Units	Conditions
$I_{F(AV)}$ Max. Average Forward Current (Per Leg) * See Fig. 5 (Per Device)	15	A	50% duty cycle @ $T_C = 105^\circ\text{C}$, rectangular wave form
	30		
I_{FSM} Max. Peak One Cycle Non-Repetitive Surge Current (Per Leg) * See Fig. 7	1000	A	5 μs Sine or 3 μs Rect. pulse
	260		10ms Sine or 6ms Rect. pulse
E_{AS} Non-Repetitive Avalanche Energy (Per Leg)	13	mJ	$T_J = 25^\circ\text{C}$, $I_{AS} = 1.50$ Amps, $L = 11.5$ mH
I_{AR} Repetitive Avalanche Current (Per Leg)	1.50	A	Current decaying linearly to zero in 1 μsec Frequency limited by T_J max. $V_A = 1.5 \times V_R$ typical

Electrical Specifications

Parameters	Values	Units	Conditions
V_{FM} Max. Forward Voltage Drop (Per Leg) * See Fig. 1 (1)	0.62	V	@ 15A $T_J = 25^\circ\text{C}$
	0.82	V	@ 30A
	0.56	V	@ 15A $T_J = 125^\circ\text{C}$
	0.71	V	@ 30A
I_{RM} Max. Reverse Leakage Current (Per Leg) * See Fig. 2 (1)	0.80	mA	$T_J = 25^\circ\text{C}$
	45	mA	$T_J = 125^\circ\text{C}$ $V_R = \text{rated } V_R$
$V_{F(TO)}$ Threshold Voltage	0.39	V	$T_J = T_J \text{ max.}$
r_t Forward Slope Resistance	8.47	m Ω	
C_T Max. Junction Capacitance (Per Leg)	720	pF	$V_R = 5V_{DC}$ (test signal range 100Khz to 1Mhz) 25°C
L_S Typical Series Inductance (Per Leg)	8.0	nH	Measured lead to lead 5mm from package body
dv/dt Max. Voltage Rate of Change (Rated V_R)	10000	V/ μs	

(1) Pulse Width < 300 μs , Duty Cycle <2%

Thermal-Mechanical Specifications

Parameters	Values	Units	Conditions
T_J Max. Junction Temperature Range	-55 to 150	$^\circ\text{C}$	
T_{stg} Max. Storage Temperature Range	-55 to 150	$^\circ\text{C}$	
R_{thJC} Max. Thermal Resistance Junction to Case (Per Leg)	3.25	$^\circ\text{C/W}$	DC operation
R_{thJC} Max. Thermal Resistance Junction to Case (Per Package)	1.63	$^\circ\text{C/W}$	DC operation
R_{thCS} Typical Thermal Resistance, Case to Heatsink	0.50	$^\circ\text{C/W}$	Mounting surface, smooth and greased (only for TO-220)
wt Approximate Weight	2 (0.07)	g (oz.)	
T Mounting Torque	Min.	6 (5)	Kg-cm (lbf-in)
	Max.	12 (10)	

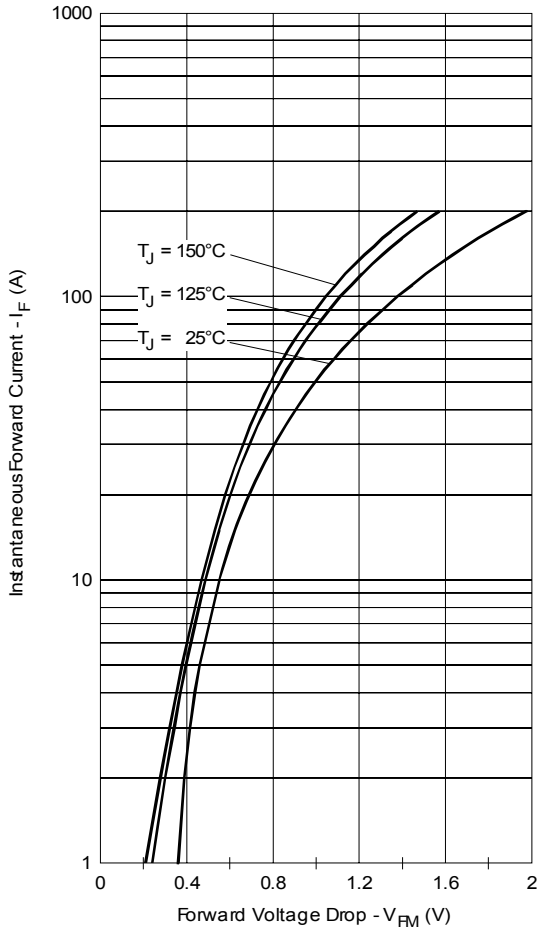

Fig. 1 - Max. Forward Voltage Drop Characteristics (Per Leg)

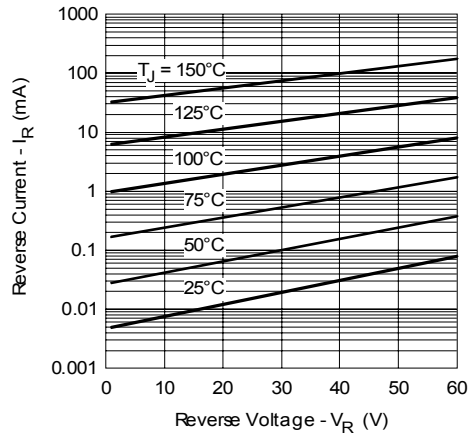

Fig. 2 - Typical Values Of Reverse Current Vs. Reverse Voltage (Per Leg)

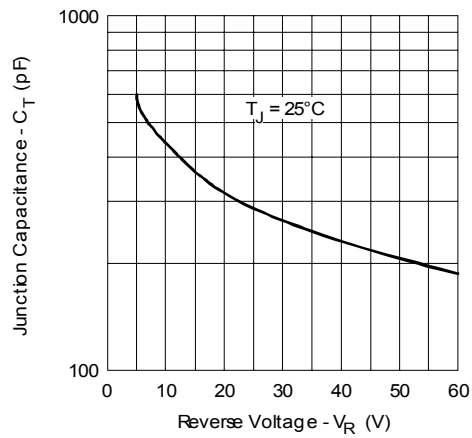

Fig. 3 - Typical Junction Capacitance Vs. Reverse Voltage (Per Leg)

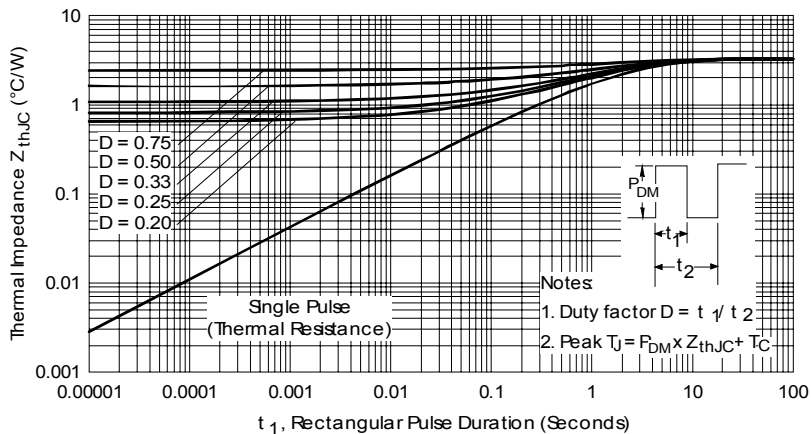

Fig. 4 - Max. Thermal Impedance Z_{thJC} Characteristics (Per Leg)

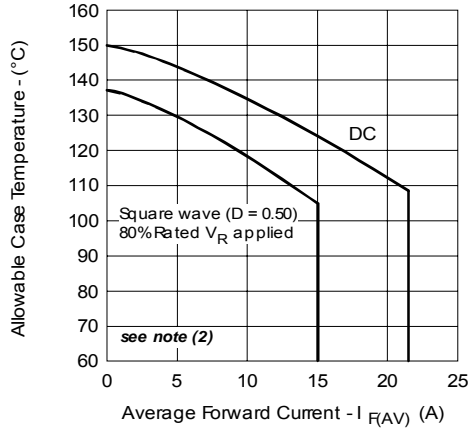

Fig. 5 - Max. Allowable Case Temperature Vs. Average Forward Current (Per Leg)

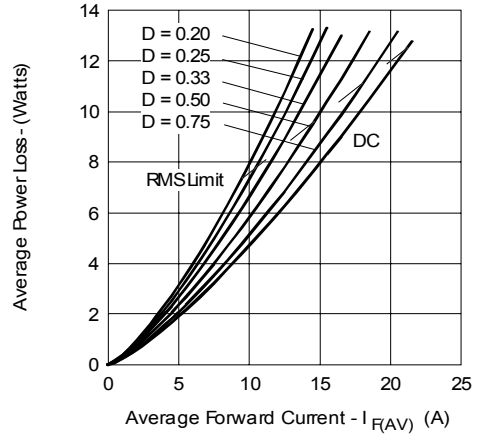

Fig. 6 - Forward Power Loss Characteristics (Per Leg)

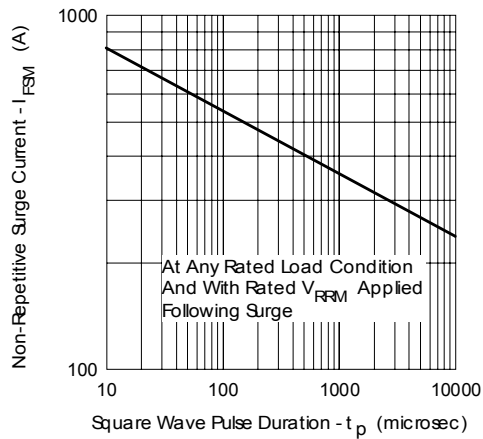

Fig. 7 - Max. Non-Repetitive Surge Current (Per Leg)

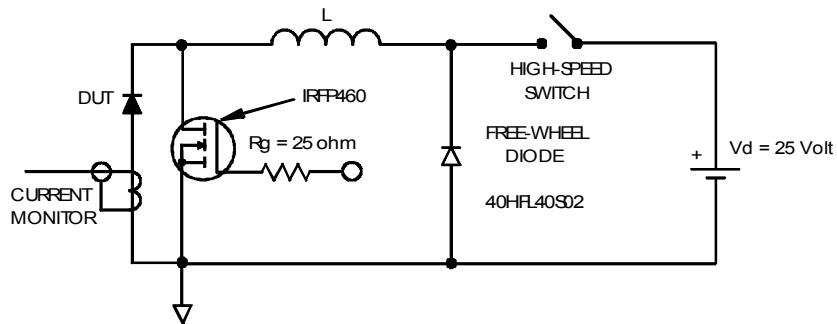

Fig. 8 - Unclamped Inductive Test Circuit

- (2) Formula used: $T_c = T_j - (Pd + Pd_{REV}) \times R_{thJC}$;
 $Pd = \text{Forward Power Loss} = I_{F(AV)} \times V_{FM} @ (I_{F(AV)} / D)$ (see Fig. 6);
 $Pd_{REV} = \text{Inverse Power Loss} = V_{R1} \times I_{R1} (1 - D); I_{R1} @ V_{R1} = 10 \text{ V}$

Outline Table

NOTES:

1. DIMENSIONING AND TOLERANCING PER ASME Y14.5M-1994.
2. DIMENSIONS ARE SHOWN IN MILLIMETERS [INCHES].
3. LEAD DIMENSIONS AND FLASH UNCONTROLLED IN C1.
4. DIMENSION D, D1 & E DO NOT INCLUDE MOLD FLASH. MOLD FLASH SHALL NOT EXCEED 0.127 [0.005] PER SIDE. THESE DIMENSIONS ARE MEASURED AT THE OUTMOST EXTREMES OF THE PLASTIC BODY.
5. DIMENSION B1, B2 & C1 APPLY TO BASE METAL ONLY.
6. CONTROLLING DIMENSION: INCHES.
7. THERMAL PAD CONTROL OPTIONAL. WITHIN DIMENSIONS L4, L2 & E1.
8. DIMENSION C2 IS AT DESIGN & TOLERANCE TYPING AND SIMILATION UNREGULATED ARE ALLOWED.
9. DIMENSION C2 IS AT DESIGN & TOLERANCE TYPING AND SIMILATION UNREGULATED ARE ALLOWED.
10. DIMENSIONS ARE DERIVED FROM THE ACTUAL PACKAGE OUTLINE.

SYMBOL	MILLIMETERS		INCHES		NOTES
	MIN.	MAX.	MIN.	MAX.	
A	3.30	4.83	.140	.190	
A1	0.91	1.40	.020	.055	
A2	2.03	2.82	.080	.115	
b	0.38	1.01	.015	.040	
b1	0.38	0.97	.015	.038	5
b2	1.14	1.78	.045	.070	
b3	1.14	1.73	.045	.068	5
c	0.38	0.61	.014	.024	
c1	0.38	0.58	.014	.022	
D	14.22	16.51	.560	.650	4
D1	8.38	9.02	.330	.355	
D2	11.68	12.88	.460	.507	
E	8.65	10.67	.380	.420	4, 7
E1	6.06	8.89	.270	.350	7
E2	-	0.78	-	.030	4
e	2.54	BSC	.100	BSC	
H	5.84	6.88	.230	.270	7, 8
L	12.70	14.73	.500	.580	
L1	-	6.35	-	.250	
MP	5.54	4.08	.139	.161	
Q	2.54	3.42	.100	.135	

LEAD ASSIGNMENTS

1. - GATE
 2. - DRAIN
 3. - SOURCE

SYMBOLS

1. - GATE
 2. - DRAIN
 3. - SOURCE

UNIT CONVERSIONS

1. - GATE
 2. - DRAIN
 3. - SOURCE

UNIT CONVERSIONS

1. - ANODE *
 2. - CATHODE
 3. - ANODE

* PART DEPENDENT.

Conform to JEDEC outline TO-220AB

NOTES:

1. DIMENSIONING AND TOLERANCING PER ASME Y14.5M-1994.
2. DIMENSIONS ARE SHOWN IN MILLIMETERS [INCHES].
3. DIMENSION D & E DO NOT INCLUDE MOLD FLASH. MOLD FLASH SHALL NOT EXCEED 0.127 [0.005] PER SIDE. THESE DIMENSIONS ARE MEASURED AT THE OUTMOST EXTREMES OF THE PLASTIC BODY.
4. DIMENSION B1 AND C1 APPLY TO BASE METAL ONLY.
5. CONTROLLING DIMENSION: INCH.

SYMBOL	MILLIMETERS		INCHES		NOTES
	MIN.	MAX.	MIN.	MAX.	
A	4.06	4.83	.160	.190	
A1	0.00	0.254	.000	.010	
b	0.51	0.99	.020	.039	
b1	0.51	0.89	.020	.035	4
b2	1.14	1.78	.045	.070	
c	0.38	0.74	.015	.029	
c1	0.38	0.58	.015	.023	4
c2	1.14	1.65	.045	.065	
D	8.51	9.65	.335	.380	3
D1	6.86		.270		
E	9.65	10.67	.380	.420	3
E1	6.22		.245		
e	2.54	BSC	.100	BSC	
H	14.61	15.88	.575	.625	
L	1.78	2.79	.070	.110	
L1	-	1.65	-	.065	
L2	1.27	1.78	.050	.070	
L3	0.25	BSC	.010	BSC	
L4	4.78	5.28	.188	.208	
m	17.78		.700		
m1	8.89		.350		
n	11.43		.450		
o	2.08		.082		
p	3.81		.150		
r	0.51	0.71	.020	.028	
R	90°	93°	90°	93°	

LEAD ASSIGNMENTS

1. - GATE
 2. 4. - DRAIN
 3. - SOURCE

IGBTs, CoPACK

1. - GATE
 2. 4. - COLLECTOR
 3. - EMITTER

DIODES

1. - ANODE *
 2. 4. - CATHODE
 3. - ANODE

* PART DEPENDENT.

Conform to JEDEC outline D²Pak (SMD-220)
 Dimensions in millimeters and (inches)

Outline Table

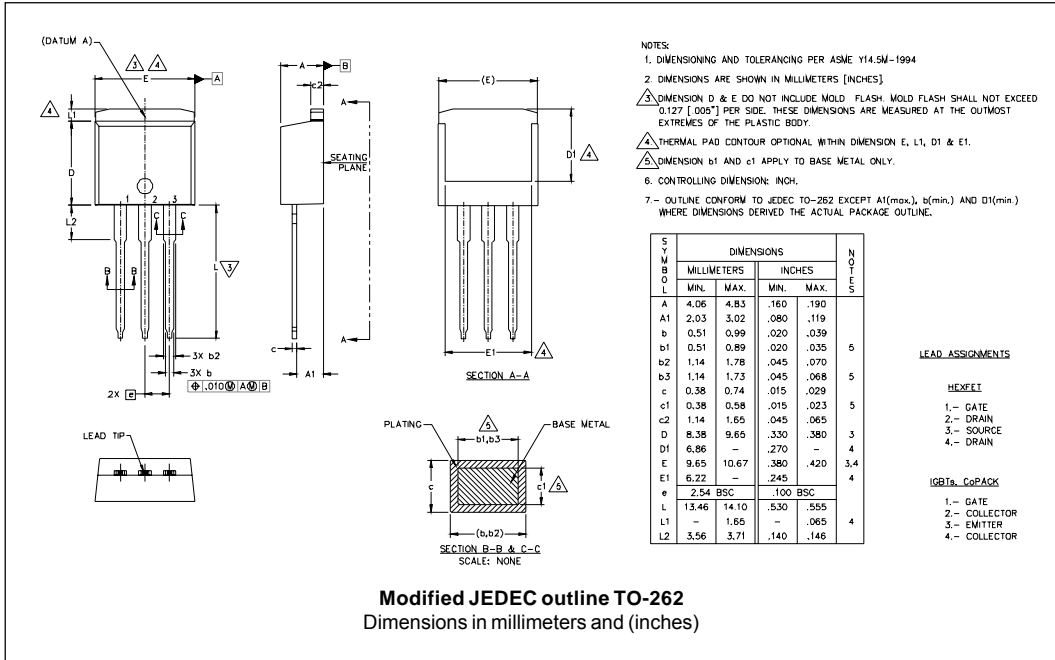

Tape & Reel Information

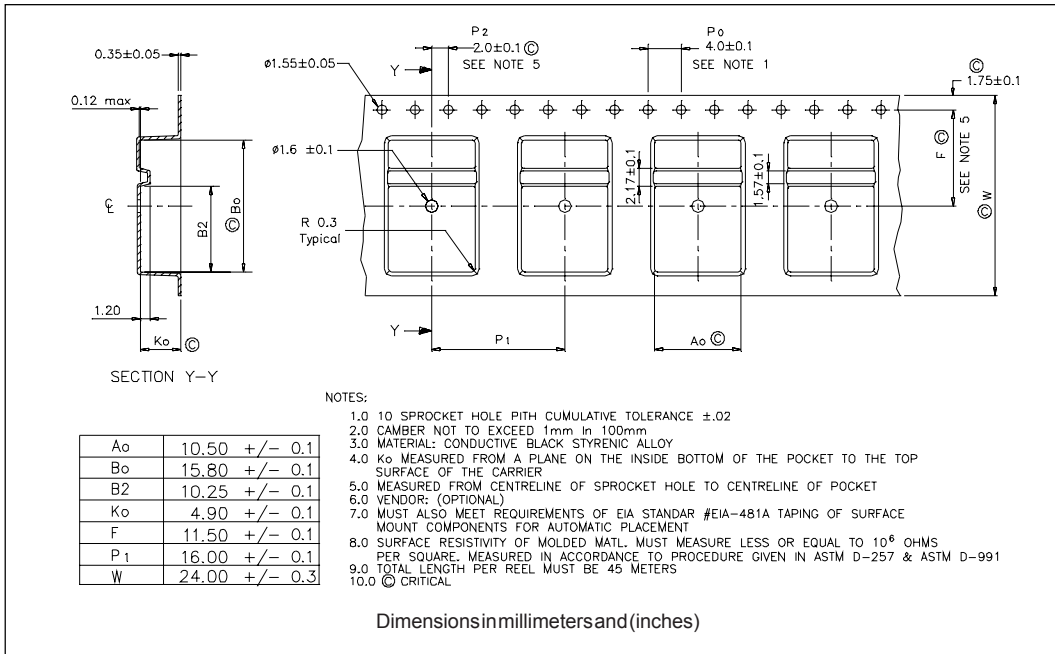

Part Marking Information

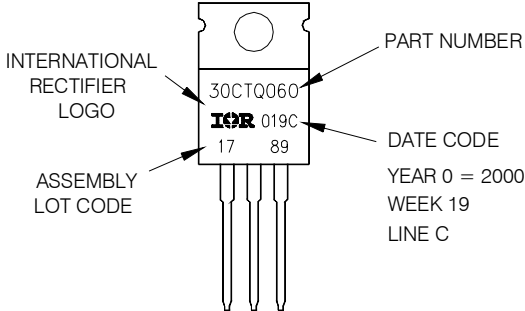
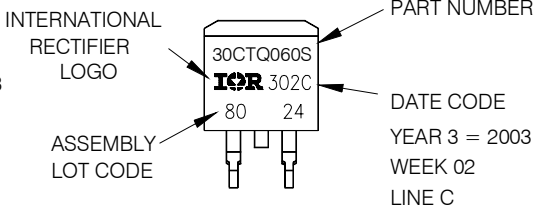
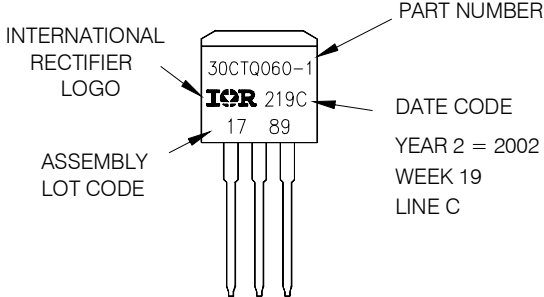
<p>TO-220</p>	<p>EXAMPLE: THIS IS A 30CTQ060 LOT CODE 1789 ASSEMBLED ON WW 19, 2000 IN THE ASSEMBLY LINE "C"</p>	 <p>INTERNATIONAL RECTIFIER LOGO</p> <p>ASSEMBLY LOT CODE</p> <p>PART NUMBER</p> <p>DATE CODE YEAR 0 = 2000 WEEK 19 LINE C</p>
<p>D²PAK</p>	<p>EXAMPLE: THIS IS A 30CTQ060S LOT CODE 8024 ASSEMBLED ON WW 02, 2003 IN ASSEMBLY LINE "C"</p>	 <p>INTERNATIONAL RECTIFIER LOGO</p> <p>ASSEMBLY LOT CODE</p> <p>PART NUMBER</p> <p>DATE CODE YEAR 3 = 2003 WEEK 02 LINE C</p>
<p>TO-262</p>	<p>EXAMPLE: THIS IS A 30CTQ060-1 LOT CODE 1789 ASSEMBLED ON WW 19, 2002 IN ASSEMBLY LINE "C"</p>	 <p>INTERNATIONAL RECTIFIER LOGO</p> <p>ASSEMBLY LOT CODE</p> <p>PART NUMBER</p> <p>DATE CODE YEAR 2 = 2002 WEEK 19 LINE C</p>

Ordering Information Table

Device Code																	
	<table border="1" style="display: inline-table; border-collapse: collapse;"> <tr> <td style="padding: 2px 10px;">30</td> <td style="padding: 2px 10px;">C</td> <td style="padding: 2px 10px;">T</td> <td style="padding: 2px 10px;">Q</td> <td style="padding: 2px 10px;">060</td> <td style="padding: 2px 10px;">S</td> <td style="padding: 2px 10px;">TRL</td> <td style="padding: 2px 10px;">-</td> </tr> <tr> <td style="text-align: center;">①</td> <td style="text-align: center;">②</td> <td style="text-align: center;">③</td> <td style="text-align: center;">④</td> <td style="text-align: center;">⑤</td> <td style="text-align: center;">⑥</td> <td style="text-align: center;">⑦</td> <td style="text-align: center;">⑧</td> </tr> </table>	30	C	T	Q	060	S	TRL	-	①	②	③	④	⑤	⑥	⑦	⑧
30	C	T	Q	060	S	TRL	-										
①	②	③	④	⑤	⑥	⑦	⑧										
1	- Current Rating (30A)																
2	- Circuit Configuration C = Common Cathode																
3	- T = TO-220																
4	- Schottky "Q" Series																
5	- Voltage Ratings																
6	- • S = D ² Pak • -1 = TO-262																
7	- • none = Tube (50 pieces) • TRL = Tape & Reel (Left Oriented - for D ² Pak only) • TRR = Tape & Reel (Right Oriented - for D ² Pak only)																
8	- • none = Standard Production • PbF = Lead-Free																

050 = 50V
060 = 60V

Data and specifications subject to change without notice.
 This product has been designed and qualified for Industrial Level.
 Qualification Standards can be found on IR's Web site.



Notice

The products described herein were acquired by Vishay Intertechnology, Inc., as part of its acquisition of International Rectifier's Power Control Systems (PCS) business, which closed in April 2007. Specifications of the products displayed herein are pending review by Vishay and are subject to the terms and conditions shown below.

Specifications of the products displayed herein are subject to change without notice. Vishay Intertechnology, Inc., or anyone on its behalf, assumes no responsibility or liability for any errors or inaccuracies.



Information contained herein is intended to provide a product description only. No license, express or implied, by estoppel or otherwise, to any intellectual property rights is granted by this document. Except as provided in Vishay's terms and conditions of sale for such products, Vishay assumes no liability whatsoever, and disclaims any express or implied warranty, relating to sale and/or use of Vishay products including liability or warranties relating to fitness for a particular purpose, merchantability, or infringement of any patent, copyright, or other intellectual property right.

The products shown herein are not designed for use in medical, life-saving, or life-sustaining applications. Customers using or selling these products for use in such applications do so at their own risk and agree to fully indemnify Vishay for any damages resulting from such improper use or sale.

International Rectifier®, IR®, the IR logo, HEXFET®, HEXSense®, HEXDIP®, DOL®, INTERO®, and POWIRTRAIN® are registered trademarks of International Rectifier Corporation in the U.S. and other countries. All other product names noted herein may be trademarks of their respective owners.

Looking for pricing, stock, or lifecycle information?

Click below to explore more details on WIN SOURCE:

-  [View 30CTQ060-1PBF on WIN SOURCE](#)
-  [Vishay Information](#)

Optimize Your Supply Chain with WIN SOURCE Solutions

-  Global Sourcing Solution
-  Obsolete Management
-  Cost Control Management
-  Shortage Management
-  Alternative Solution
-  Excess Inventory Management