



**THE DATASHEET OF
NSR15TW1T2G**



NSR15TW1

Triple RF Schottky Diode

These diodes are designed for analog and digital applications, including DC based signal detection and mixing applications.

Features:

- Low Capacitance (<1 pF)
- Low V_F (390 mV typical @ 1 mA)
- Low V_{FA} (1 mV typical @ 1 mA)

Benefits:

- Reduced Parasitic Losses
- Accurate Signal Measurement

MAXIMUM RATINGS

Rating	Symbol	Max	Unit
Peak Reverse Voltage	V_R	15	V
Forward Current	I_F	30	mA
Operating and Storage Temperature Range	T_J, T_{stg}	-65 to +150	°C
ESD Rating: Class 1 per Human Body Model Class A per Machine Model			

THERMAL CHARACTERISTICS

Characteristic	Symbol	Value	Unit
Maximum Thermal Resistance – Junction to Ambient	$R_{\theta JA}$	500	°C/W



ON Semiconductor™

<http://onsemi.com>

**RF SCHOTTKY
BARRIER DIODES
15 VOLTS, 30 mA**

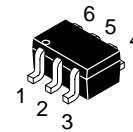
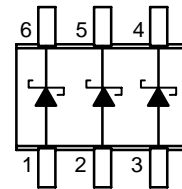

SC-88
CASE 419B
STYLE 15

MARKING DIAGRAM

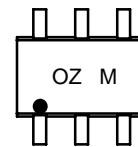

OZ = Specific Device Code
M = Date Code

ORDERING INFORMATION

Device	Package	Shipping
NSR15TW1T2	SC-88	3000/Tape & Reel

NSR15TW1

ELECTRICAL CHARACTERISTICS

Characteristic	Symbol	Min	Typ	Max	Unit
Breakdown Voltage ($I_R = 10 \mu\text{A}$)	V_{BR}	15	20	–	V
Reverse Leakage ($V_R = 1 \text{ V}$)	I_R	–	2	50	nA
Forward Voltage ($I_F = 1 \text{ mA}$)	V_{F1}	–	390	415	mV
Forward Voltage ($I_F = 10 \text{ mA}$)	V_{F2}	–	530	680	mV
Delta V_F ($I_F = 1 \text{ mA}$, All Diodes)	ΔV_F	–	1	15	mV
Capacitance ($V_F = 0 \text{ V}$, $f = 1 \text{ MHz}$)	C_T	–	0.8	1	pF

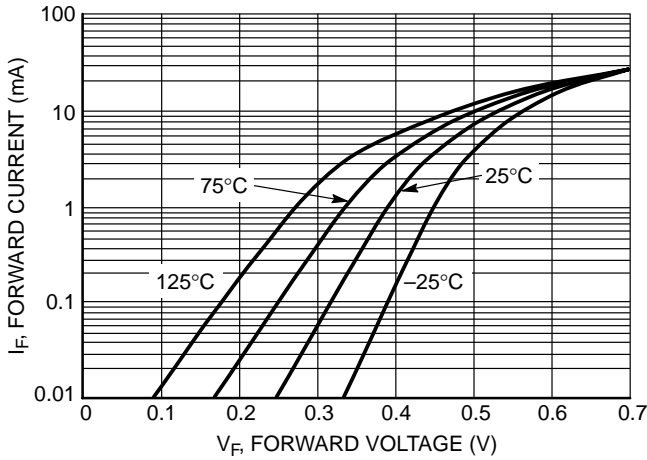

Figure 1. Forward Current versus Forward Voltage at Temperatures

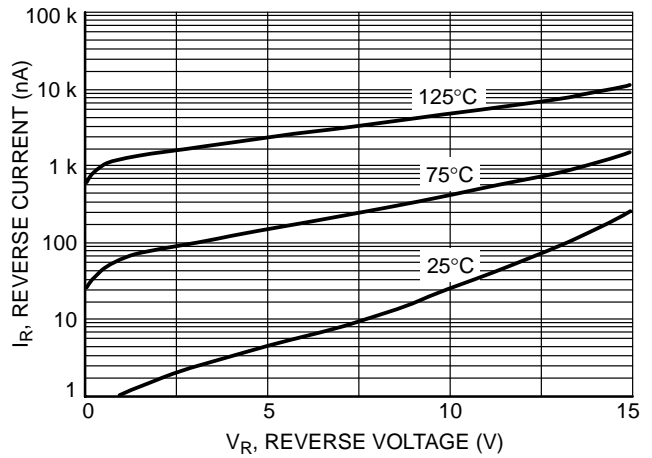

Figure 2. Reverse Current versus Reverse Voltage

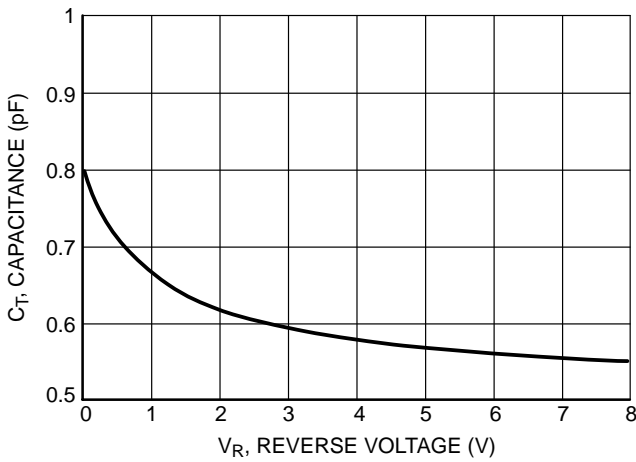

Figure 3. Total Capacitance versus Reverse Voltage

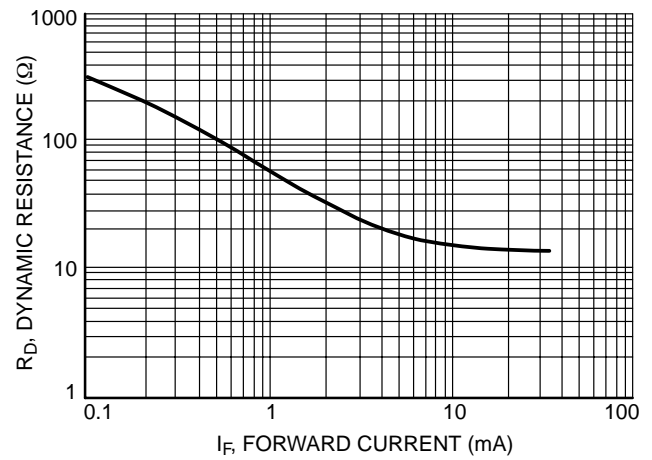

Figure 4. Dynamic Resistance versus Forward Current

NSR15TW1

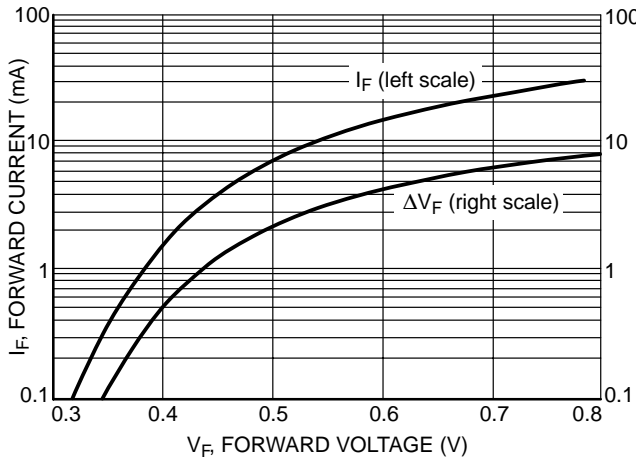

Figure 5. Typical V_F Match at Mixer Bias Levels

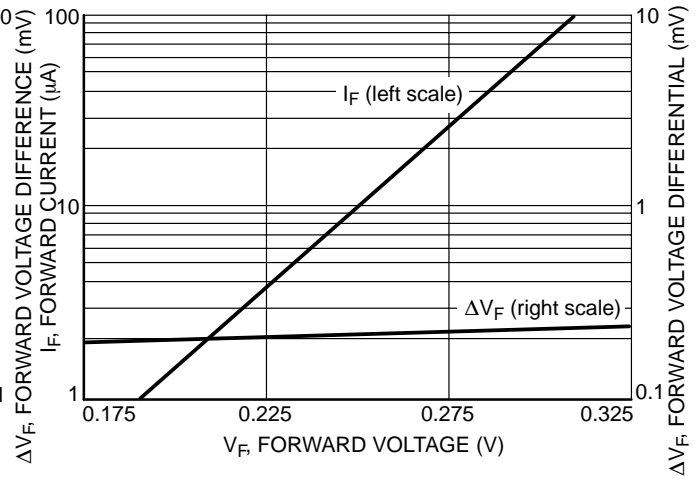

Figure 6. Typical V_F Match at Detector Bias Levels

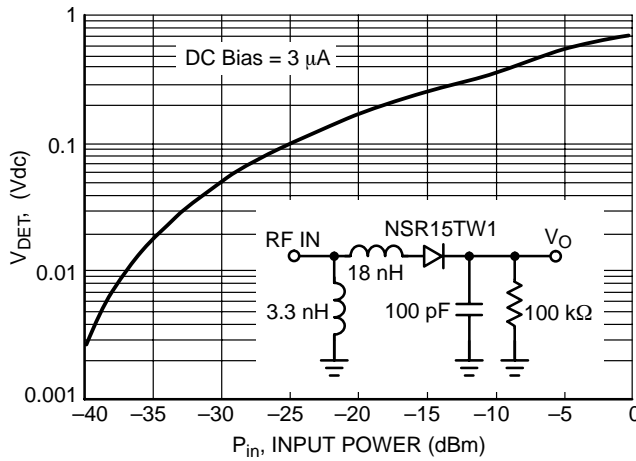

Figure 7. Typical Output Voltage versus Input Power, Small Signal Detector Operating at 850 MHz

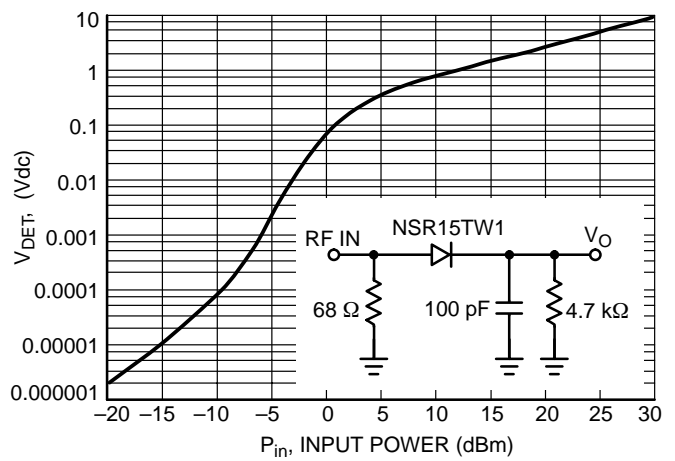

Figure 8. Typical Output Voltage versus Input Power, Large Signal Detector Operating at 915 MHz

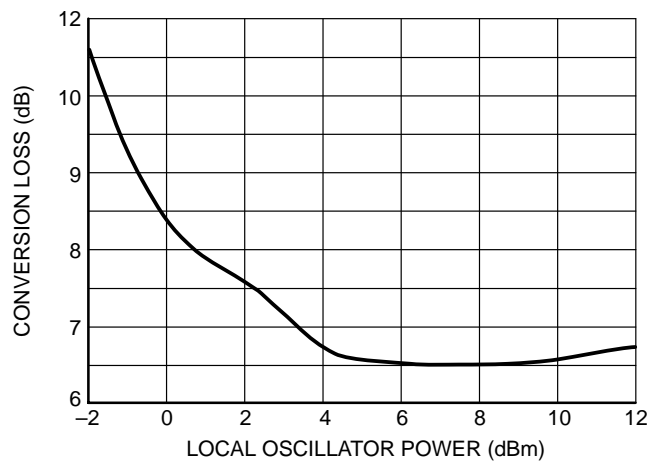
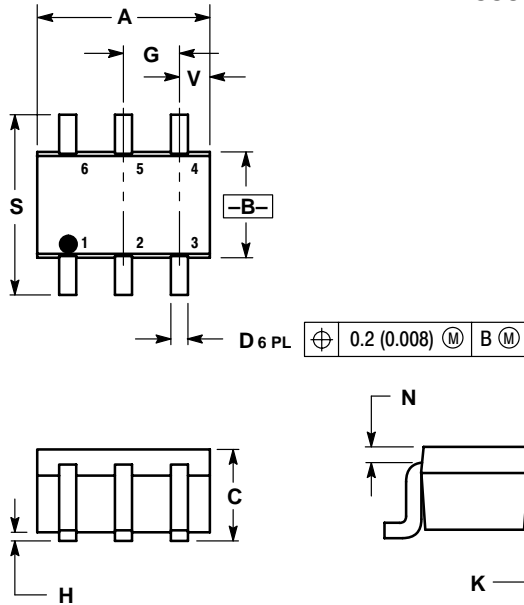

Figure 9. Typical Conversion Loss versus L.O. Drive, 2.0 GHz

NSR15TW1

PACKAGE DIMENSIONS

SC-88 (SOT-363)
CASE 419B-01
ISSUE G



- NOTES:
1. DIMENSIONING AND TOLERANCING PER ANSI Y14.5M, 1982.
 2. CONTROLLING DIMENSION: INCH.

DIM	INCHES		MILLIMETERS	
	MIN	MAX	MIN	MAX
A	0.071	0.087	1.80	2.20
B	0.045	0.053	1.15	1.35
C	0.031	0.043	0.80	1.10
D	0.004	0.012	0.10	0.30
G	0.026 BSC		0.65 BSC	
H	---	0.004	---	0.10
J	0.004	0.010	0.10	0.25
K	0.004	0.012	0.10	0.30
N	0.008 REF		0.20 REF	
S	0.079	0.087	2.00	2.20
V	0.012	0.016	0.30	0.40

- STYLE 15:
PIN 1. ANODE
2. ANODE
3. ANODE
4. CATHODE
5. CATHODE
6. CATHODE

ON Semiconductor and  are trademarks of Semiconductor Components Industries, LLC (SCILLC). SCILLC reserves the right to make changes without further notice to any products herein. SCILLC makes no warranty, representation or guarantee regarding the suitability of its products for any particular purpose, nor does SCILLC assume any liability arising out of the application or use of any product or circuit, and specifically disclaims any and all liability, including without limitation special, consequential or incidental damages. "Typical" parameters which may be provided in SCILLC data sheets and/or specifications can and do vary in different applications and actual performance may vary over time. All operating parameters, including "Typicals" must be validated for each customer application by customer's technical experts. SCILLC does not convey any license under its patent rights nor the rights of others. SCILLC products are not designed, intended, or authorized for use as components in systems intended for surgical implant into the body, or other applications intended to support or sustain life, or for any other application in which the failure of the SCILLC product could create a situation where personal injury or death may occur. Should Buyer purchase or use SCILLC products for any such unintended or unauthorized application, Buyer shall indemnify and hold SCILLC and its officers, employees, subsidiaries, affiliates, and distributors harmless against all claims, costs, damages, and expenses, and reasonable attorney fees arising out of, directly or indirectly, any claim of personal injury or death associated with such unintended or unauthorized use, even if such claim alleges that SCILLC was negligent regarding the design or manufacture of the part. SCILLC is an Equal Opportunity/Affirmative Action Employer.

PUBLICATION ORDERING INFORMATION

Literature Fulfillment:

Literature Distribution Center for ON Semiconductor
P.O. Box 5163, Denver, Colorado 80217 USA
Phone: 303-675-2175 or 800-344-3860 Toll Free USA/Canada
Fax: 303-675-2176 or 800-344-3867 Toll Free USA/Canada
Email: ONlit@hibbertco.com

N. American Technical Support: 800-282-9855 Toll Free USA/Canada

JAPAN: ON Semiconductor, Japan Customer Focus Center
4-32-1 Nishi-Gotanda, Shinagawa-ku, Tokyo, Japan 141-0031
Phone: 81-3-5740-2700
Email: r14525@onsemi.com

ON Semiconductor Website: <http://onsemi.com>

For additional information, please contact your local Sales Representative.

Looking for pricing, stock, or lifecycle information?

Click below to explore more details on WIN SOURCE:

 [View NSR15TW1T2G on WIN SOURCE](#)

 [ON Semiconductor](#) Information

Optimize Your Supply Chain with WIN SOURCE Solutions

-  Global Sourcing Solution
-  Obsolete Management
-  Cost Control Management
-  Shortage Management
-  Alternative Solution
-  Excess Inventory Management