



# THE DATASHEET OF NRF6910



# nRFready ANT USB Dongle

nRF6910

## User Guide v1.0

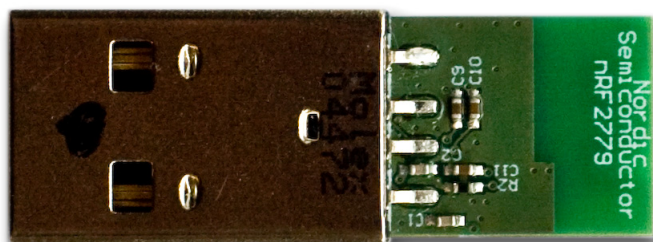
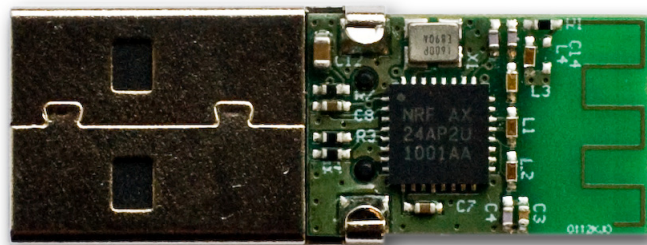

All rights reserved.

Reproduction in whole or in part is prohibited without the prior written permission of the copyright holder.

June 2010

## Liability disclaimer

Nordic Semiconductor ASA reserves the right to make changes without further notice to the product to improve reliability, function or design. Nordic Semiconductor ASA does not assume any liability arising out of the application or use of any product or circuits described herein.

## Life support applications

These products are not designed for use in life support appliances, devices, or systems where malfunction of these products can reasonably be expected to result in personal injury. Nordic Semiconductor ASA customers using or selling these products for use in such applications do so at their own risk and agree to fully indemnify Nordic Semiconductor ASA for any damages resulting from such improper use or sale.

## Contact details

For your nearest dealer, please see <http://www.nordicsemi.com>.

### Main office:

Otto Nielsens vei 12  
7004 Trondheim  
Phone: +47 72 89 89 00  
Fax: +47 72 89 89 89  
[www.nordicsemi.com](http://www.nordicsemi.com)



## Revision History

Date	Version	Description
June 2010	1.0	User guide

## RoHS statement

Nordic Semiconductor's products meet the requirements of Directive 2002/95/EC of the European Parliament and of the Council on the Restriction of Hazardous Substances (RoHS). Complete hazardous substance reports as well as material composition reports for all active Nordic Semiconductor products can be found on our web site [www.nordicsemi.com](http://www.nordicsemi.com).

---

## Contents

<b>1</b>	<b>Introduction .....</b>	<b>4</b>
1.1	Prerequisites .....	4
1.2	Writing Conventions .....	4
<b>2</b>	<b>Software features .....</b>	<b>5</b>
2.1	Installing the USB dongle .....	5
2.2	Start using the USB dongle .....	5
2.3	Creating your first application .....	5
2.4	Reference design content .....	6
2.5	Troubleshooting .....	6
<b>3</b>	<b>Hardware descriptions .....</b>	<b>7</b>
3.1	Schematic .....	7
3.2	Power supply .....	7
3.3	Matching network .....	8
3.4	Antenna .....	8
3.5	Printed circuit board .....	8
3.6	Layout .....	9
3.7	Bill of Materials .....	10

## 1 Introduction

This reference design provides all the hardware and software you need to evaluate and start developing an ANT USB dongle.

The nRFready ANT USB dongle reference kit consists of:

- Miniature USB dongle
- Altium design files
- Compliance reports
- Demo applications with source code
- Library and drivers with source code

All documentation and software must be downloaded from the nRF24AP2-USB product page at [www.nordicsemi.com](http://www.nordicsemi.com).

The nRF24AP2-USB, with its USB v2.0 compatible serial interface, is made specifically to act as a bridge between an ANT wireless network and backbone infrastructure. Backbone infrastructure can be advanced user interfaces, storage on a computer or other USB enabled equipment.

### 1.1 Prerequisites

To fully understand this User Guide a background in software development and/or electronic engineering is required.

Before you start developing you should read the *ANT Message Protocol and Usage* document and the *nRF24AP2-USB Product Specification*. These two documents provide detailed information about the capabilities and functionality of the nRF24AP2-USB.

### 1.2 Writing Conventions

This user guide follows a set of typographic rules to make the document consistent and easy to read. The following writing conventions are used:

- Pin names and commands are written in `Courier New` **bold**.
- File names and User Interface components are written in **bold**.
- Cross references are [underlined and highlighted in blue](#).

---

## 2 Software features

This chapter contains a description on how to install and start using the ANT USB dongle. All the software related to this release is available for download from the nRF24AP2-USB product page at [www.nordicsemi.com](http://www.nordicsemi.com).

### 2.1 Installing the USB dongle

After attaching the ANT USB dongle to the computer, the driver can be installed automatically by downloading from the Hardware Update Wizard in Windows. It's also possible to manually download the driver.

The ANT USB dongle will enumerate as product string 'ANT USB Stick 2' and Libusb-win32 device type.

Libusb-win32 is a library that allows userspace application to access USB devices on Windows operation systems. It is derived from and fully API compatible to libusb, available at <http://libusb.sourceforge.net>.

For more information visit the project's web site at:

<http://libusb-win32.sourceforge.net>

<http://sourceforge.net/projects/libusb-win32>

### 2.2 Start using the USB dongle

ANTWare is an application used for the control of ANT wireless devices. It is an excellent tool for first time ANT developers to explore the capabilities of ANT as a low power wireless solution, and for experienced users to easily setup and monitor advanced ANT networks.

ANTWare II improves upon past versions with a new interface, streamlined functions, and a variety of new features. The ANTWare II application and user guide are available for download.

### 2.3 Creating your first application

The ANT Windows Library Package and ANT Library MacOSX Package are the preferred starting point to start developing your first application. These packages contains demo applications written for generic C and C++ compilers, for instance Borland Builder and GCC. See the **readme.txt** file in each package for more information.

## 2.4 Reference design content

All reference design contents must be downloaded from [www.nordicsemi.com](http://www.nordicsemi.com). The nRFready ANT USB dongle is purchased separately (ordering code: nRF6910).

The following bullet points give an overview of the contents:

- Documents
  - **nRF24AP2-USB Product Specification.pdf**
  - **nRFready ANT USB Dongle Reference Design User Guide.pdf** (this document)
  - **nRFready ANT USB dongle ETSI 300 440 report.pdf**
  - **nRFready ANT USB dongle FCC part 15 report.pdf**
  - **nRFready ANT USB dongle USB certification report.pdf**
  - **ANT Message Protocol and Usage.pdf**
  - **ANTWare II User Guide.pdf**
- Hardware files
  - **nRFready ANT USB dongle reference design.zip**
- Applications
  - **ANTWare\_II.zip**
- Source code
  - **ANT\_USB2\_Windows\_Package.zip**
  - **ANT\_USB2\_Mac\_Package.zip**
- Windows
  - **ANT\_USB2\_Windows\_Driver.zip**

Version numbers of the above-mentioned files are omitted here since they are updated regularly.

## 2.5 Troubleshooting

Make sure to download the latest documentation and software from the nRF24AP2-USB product page at [www.nordicsemi.com](http://www.nordicsemi.com) or [www.thisisant.com](http://www.thisisant.com).

You can find general information about development with ANT and ANT+ at [www.thisisant.com](http://www.thisisant.com), while [www.nordicsemi.com](http://www.nordicsemi.com) contains specific information about development for the nRF24AP2 product variants:

- nRF24AP2-USB
- nRF24AP2-1CH
- nRF24AP2-8CH

Contact technical support for further assistance.

### 3 Hardware descriptions

This chapter contains a description of the schematic, layout and BOM for the ANT USB dongle. The nRFready ANT USB dongle reference design consists of Altium Designer 6 files, gerber files, schematic and PCB layout plots in pdf-format.

#### 3.1 Schematic

The nRFready ANT USB dongle is based on the schematic in the nRF24AP2-USB Product Specification. shows the nRF24AP2-USB dongle circuit diagram. The PCB layout is shown in [section 3.6 on page 9](#). The Bill of Material, BOM, is listed in [section 3.7 on page 10](#).

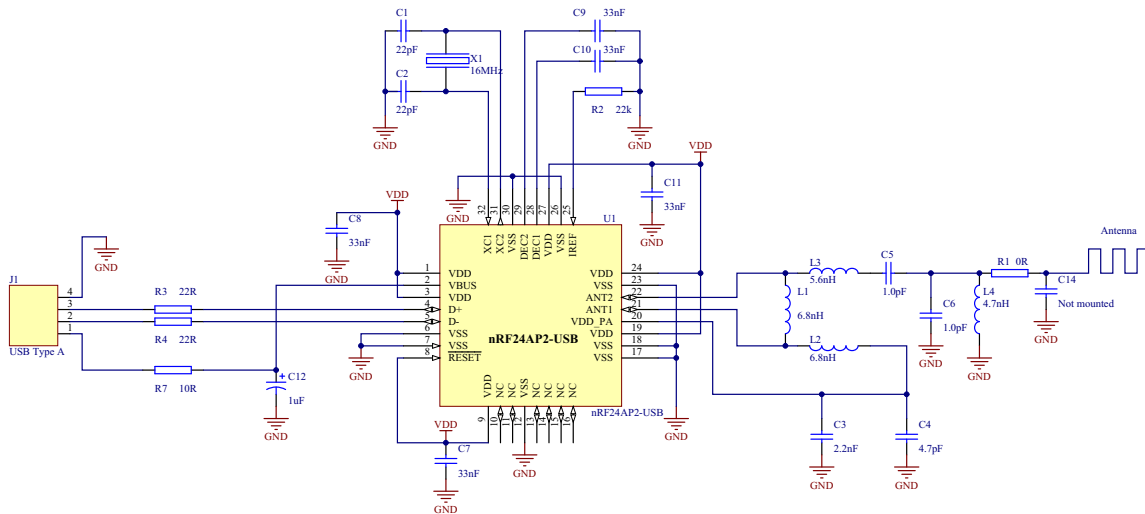

Figure 1. nRF24AP2-USB schematic

#### 3.2 Power supply

The nRF24AP2-USB is connected to the USB 5V supply through a 10Ω resistor. Together with the capacitor C12, it forms a low pass filter to filter noise on the power supply. The nRF24AP2-USB has a built-in voltage regulator that supplies internal circuitry. No extra power regulator is needed in this design. The **VDD** pins are connected to one another and decoupling capacitors are placed close to the **VDD** pins, as recommended in the nRF24AP2-USB product specification.

### 3.3 Matching network

The matching network is the components between the two ANT pins on the nRF24AP2-USB and the antenna. Its function is impedance transformation and filtering. To make the USB dongle as small as possible, the layout of the matching network is changed from the reference layout in the nRF24AP2-USB product specification. To maintain the performance, the component values are changed as well. If changes are made on the layout, make sure the performance doesn't decrease, and if necessary, tune the component values.

### 3.4 Antenna

The antenna is a quarter wave meander type on PCB. The antenna impedance is matched to the 50 $\Omega$  output in the matching network with the use of L4. When the nRFready ANT USB dongle is connected to a computer, the computer adds a significant ground plane to the dongle. This means that any antenna measurements must be done with the dongle connected to the computer. Of course, not all computers are equal, so there will be compromises. The antenna in this design is tuned for this layout only. If the layout is changed, the antenna must be re-tuned. The antenna tuning is done with the pi-network consisting of L4, R1 and C14.

The reference design is delivered without housing. For a real product, some kind of housing for the dongle is needed. The presence of the housing material can have some impact on the antenna. This can be compensated by changing the values of L4 and C13 so that the antenna is resonant at the correct frequency. The exact component values must be determined by measurements.

### 3.5 Printed circuit board

To keep the size as small as possible, a two-layer, 0.8mm board is used. The material is standard FR4. Components are mounted on both sides of the board. The nRF24AP2-USB is mounted on the top layer.

### 3.6 Layout

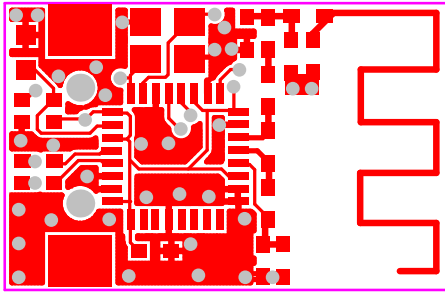

Top layer

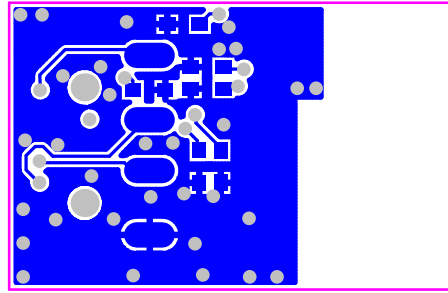

Bottom layer

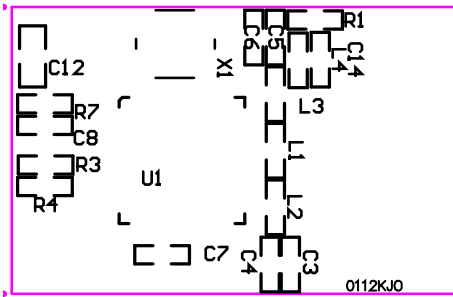

Top silk screen

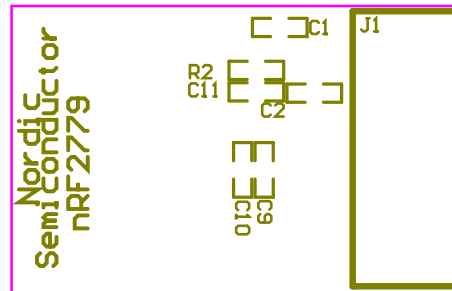

Bottom silk screen

Figure 2. nRF24AP2-USB dongle layout



### 3.7 Bill of Materials

Designator	Value	Footprint	Comment
C1, C2	22pF	0402s	NP0 +/-2%
C3	2.2nF	0402s	X7R +/-10%
C4	4.7pF	0402s	NP0 +/-2%
C5, C6	1.0pF	0402s	NP0 +/-2%
C7, C8, C9, C10, C11	33nF	0402s	X7R +/-10%
C12	1uF	0603s	X7R +/-10%, 6.3v
C14	Not mounted	0402s	Not mounted
J1	Molex 48037-1000	USB SMD	USB Type A
L1, L2	6.8nH	0402s	Murata LQP15MN6N8B02D
L3	5.6nH	0402s	Murata LQP15MN5N6B02D
L4	4.7nH	0402s	Murata LQP15MN4N7B02D
R1	0R	0402s	1%
R2	22k	0402s	1%
R3, R4	22R	0402s	1%
R7	10R	0402s	1%
U1	nRF24AP2-USB	QFN32	nRF24AP2-USB
X1	16 MHz	BT-XTAL 2520	Epson-Toyocom FA-20H 16 MHz, CL=12pF, Total tolerance (at 25°C + temp. drift + aging) = ±50ppm max, ESR=100Ω max, C0=7pF max, Operating temperature range = -20°C to +70°C min.

Table 1. Bill of materials

## Looking for pricing, stock, or lifecycle information?

Click below to explore more details on WIN SOURCE:

-  [View NRF6910 on WIN SOURCE](#)
-  [Nordic Semiconductors](#) Information

## Optimize Your Supply Chain with WIN SOURCE Solutions

-  Global Sourcing Solution
-  Obsolete Management
-  Cost Control Management
-  Shortage Management
-  Alternative Solution
-  Excess Inventory Management