



**THE DATASHEET OF
NL6EBX-DC24V**



NiS

6PDT FLATPACK 2AMP DIL RELAY

NL-RELAYS

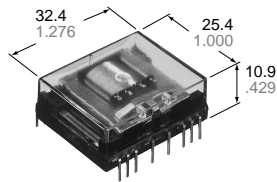

NLE Amber Relays

mm inch

FEATURES

- Space saving dimensions — 25.4 mm × 32.4 mm × 10.9 mm
1.000 inch × 1.276 inch × 0.429 inch
- Latching types available
- Low operating power — 400 mW (single side stable)
Transistor compatible
- High breakdown voltage for transient protection — 1,000 Vrms between open contacts, contact sets, and 1,500 V FCC surge between open contacts
- Soldering flux inflow completely prevented

SPECIFICATIONS

Contacts

Arrangement**1	6 Form C		
Contact material	gold-clad silver**2		
Initial contact resistance, max. (By voltage drop 6 V DC 1 A)	100 mΩ		
Rating (resistive)	Nominal switching capacity	2 A 30 V DC	
	Max. switching power	60 VA, 60 W	
	Max. switching voltage	125 V AC, 30 V DC	
	Max. switching current	2 A	
Expected life (min. operations)	Mechanical	5×10 ⁷	
	Electrical (resistive)	2 A 30 V DC	5×10 ⁵
		0.6 A 100 V DC	10 ⁶

**1 MBB contact types also available: 2 MBB, 4 MBB & 6 MBB

**2 Gold capped silver-palladium contact also available

Coil (polarized) (at 25°C 77°F)

Minimum operating power	Approx. 460 mW
Nominal operating power	up to 60 V DC: Approx. 720 mW 110 V DC: Approx. 900 mW
Minimum set and reset power	Approx. 1,000 mW
Nominal set and reset power	Approx. 1,600 mW

Remarks

- * Specifications will vary with foreign standards certification ratings.
- *1 Measurement at same location as "Initial breakdown voltage" section
- *2 Detection current: 10 mA
- *3 Excluding contact bounce time
- *4 Half-wave pulse of sine wave: 11ms; detection time: 10μs
- *5 Half-wave pulse of sine wave: 6ms
- *6 Detection time: 10μs
- *7 Refer to 5. Conditions for operation, transport and storage mentioned in AMBIENT ENVIRONMENT (Page 61).

Characteristics

Maximum operating speed		50 cps
Initial insulation resistance*1		Min. 100 MΩ at 500 V DC
Breakdown voltage*2	Between open contacts, contact sets	1,000 Vrms
	Between contacts and coil	2,000 Vrms
Operate time*3 (at nominal voltage)		Max. 15 ms (Approx. 10 ms)
Release time (without diode)*3 (at nominal voltage)		Max. 10 ms (Approx. 5 ms)
Temperature rise		Max. 65°C with nominal coil voltage and at switching current 2 A
Shock resistance	Functional*4	Min. 147 m/s ² {15 G}
	Destructive*5	Min. 980 m/s ² {100 G}
Vibration resistance	Functional*6	58.8 m/s ² {6 G}, 10 to 55 Hz at double amplitude of 1 mm
	Destructive	117.6 m/s ² {12 G}, 10 to 55 Hz at double amplitude of 2 mm
Conditions for operation, transport and storage*7 (Not freezing and condensing at low temperature)	Ambient temp.	-40°C to +55°C -40°F to +131°F
	Humidity	5 to 85% R.H.
Unit weight		Approx. 17 g 60 oz

TYPICAL APPLICATIONS

Telecommunications, security equipment, detection systems.

ORDERING INFORMATION

Ex. NL 6 EB X 6M L2 DC48V 1

Contact arrangement	Classification of type	MBB function	Operating function	Coil voltage	Contact material
6: 6 Form C	EB: Amber sealed type	Nil: 6 Form C	Nil: Single side stable L2: 2 coil latching	DC: 5, 6, 12, 24, 48, 60, 110 V	Nil: Gold-clad silver 1: Gold-cap over silver palladium

- (Notes) 1. For UL/CSA or VDE recognized types, add suffix UL/CSA or VDE.
2. Standard packing Carton: 20 pcs. Case: 200 pcs.

TYPES AND COIL DATA (at 20°C 68°F)

Single side stable

Part No.	Coil voltage, V DC			Coil resistance, Ω (±10%)	Nominal operating power, mW
	Pick-up (max.)	Drop-out (min.)	Maximum allowable		
NL6EBX-DC5V	4.0	0.5	6.0	34.7	720
NL6EBX-DC6V	4.8	0.6	7.2	50	
NL6EBX-DC12V	9.6	1.2	14.4	200	
NL6EBX-DC24V	19.2	2.4	28.8	800	
NL6EBX-DC48V	38.4	4.8	57.6	3,200	
NL6EBX-DC60V	48	6.0	72	5,000	
NL6EBX-DC110V	88	11.0	132	13,467	898

2 coil latching

Part No.	Coil voltage, * V DC			Coil resistance, Ω (±10%)	Nominal operating power, mW
	Set (max.)	Reset (max.)	Maximum allowable		
NL6EBX-L2-DC5V	4.0	4.0	5.5	15.6	1,600**
NL6EBX-L2-DC6V	4.8	4.8	6.6	22.5	
NL6EBX-L2-DC12V	9.6	9.6	13.2	90	
NL6EBX-L2-DC24V	19.2	19.2	26.4	360	
NL6EBX-L2-DC48V	38.4	38.4	52.8	1,440	
NL6EBX-L2-DC60V	48	48	66	2,250	
NL6EBX-L2-DC110V	88	88	121	7,563	

* See NOTE 2

** Two coil latching series are for intermittent operation only.

Power should be applied to coil continuously for no more than two minutes.

DIMENSIONS

mm inch

Single side stable

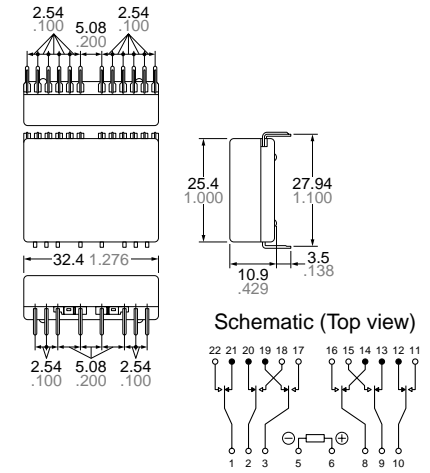

2 coil latching

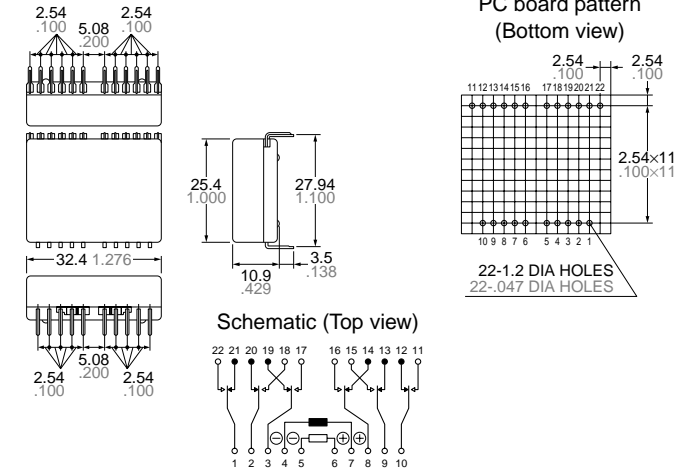

General tolerance: ±0.3 ±0.12

REFERENCE DATA

1. Electrical life (2 A 30 V DC resistive load)

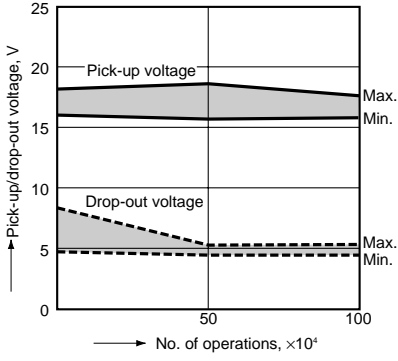

2. Coil temperature rise

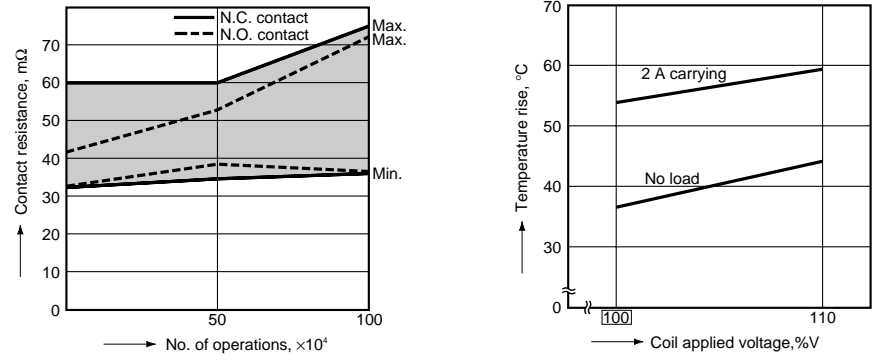

NOTES

On two coil latching relays

1. To maintain insulation between coils, terminals 6 and 7 should be connected to provide common return.

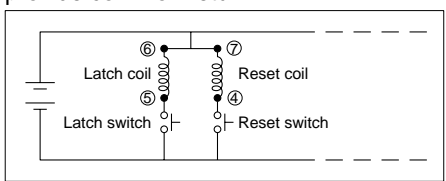



2. Two coil latching relays are for intermittent operation only. Power should be applied to coils for no more than two minutes; continuous operation may burn out the coils.

3. Position of MBB contacts
 2M (2 Form D 4 Form C):
 1-21-22, 10-11-12
 4M (4 Form D 2 Form C):
 1-21-22, 2-20-18, 9-13-15, 10-11-12

For Cautions for Use, see Relay Technical Information

Looking for pricing, stock, or lifecycle information?

Click below to explore more details on WIN SOURCE:

-  [View NL6EBX-DC24V on WIN SOURCE](#)
-  [Panasonic Information](#)

Optimize Your Supply Chain with WIN SOURCE Solutions

-  Global Sourcing Solution
-  Obsolete Management
-  Cost Control Management
-  Shortage Management
-  Alternative Solution
-  Excess Inventory Management