

C-MOS QUAD SPST ANALOG SWITCH

■ GENERAL DESCRIPTION

The NJU201A is a quad break-before-make SPST analog switch protected up to 44V operating voltage.

All switches are controlled by TTL or C-MOS compatible input.

The low on-state resistance is about half compare with the NJU7301.

The NJU201A is functionally and pin-to-pin compatible with SILICONIX DG201A.

■ PACKAGE OUTLINE

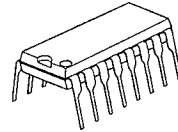

NJU201AD

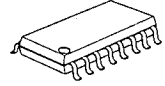

NJU201AM

■ FEATURES

- High Break Down Voltage -- 44V
- Low On-state Resistance
- Package Outline -- DIP/DMP 16
- C-MOS Technology

■ PIN CONFIGURATION

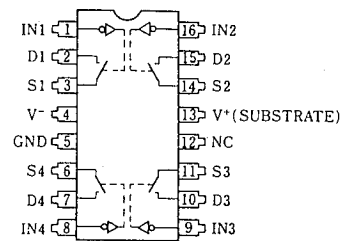
6

■ TRUTH TABLE

Logic (In)	Switch
0	ON
1	OFF

■ EQUIVALENT CIRCUIT

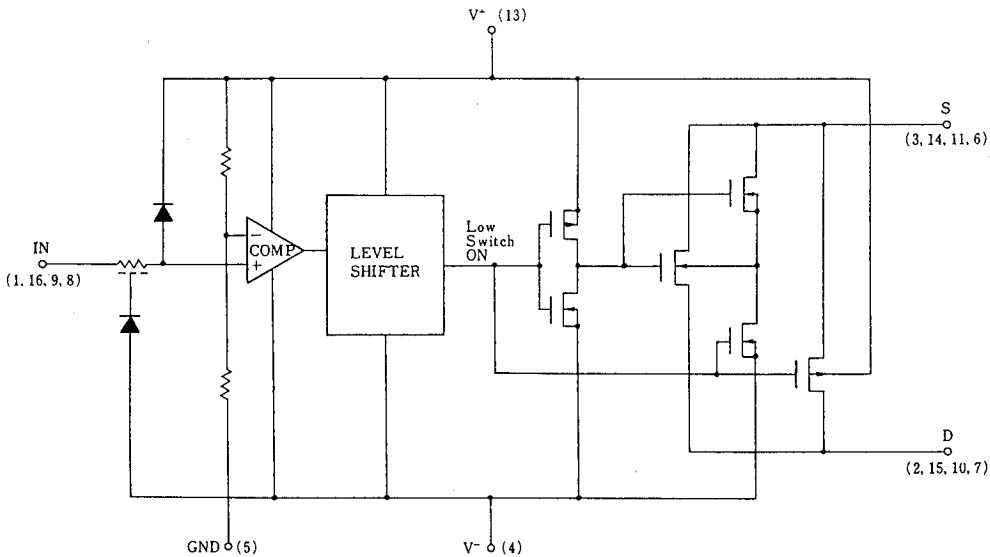

* Logic input threshold voltage V_{TH} is about $V^+ \times 0.128(V)$.
When the designing, enough margin is required.

■ TERMINAL DESCRIPTION

No.	SYMBOL	F U N C T I O N	No.	SYMBOL	F U N C T I O N
1	IN1	Control Signal Input	9	IN3	Control Signal Input
2	D1	Input/Output 1	10	D3	Input/Output 3
3	S1		11	S3	
4	V ⁻	Negative (V ⁻) Power Supply	12	NC	Non Connection
5	GND	Ground	13	V ⁺	Positive (V ⁺) Power Supply
6	S4	Input/Output 4	14	S2	Input/Output 2
7	D4		15	D2	
8	IN4	Control Signal Input	16	IN2	Control Signal Input

6

■ ABSOLUTE MAXIMUM RATINGS

(Ta=25°C)

P A R A M E T E R	SYMBOL	R A T I N G S	UNIT
Supply Voltage	V ⁺ - V ⁻	44	V
	V ⁺ - GND	19	
	GND - V ⁻	25	
Input Voltage	V _I , V _S , V _D	V ⁻ -0.5 ~ V ⁺ +0.5 *	V
Input Current	I _I	30	mA
	I _S , I _D Continuous	20	
	Peak Value (PW=1ms, Duty0.1)	70	
Power Dissipation	P _D	500 (DIP)/ 200 (DMP)	mW
Operating Temperature Range	T _{opr}	0 ~ + 70	°C
Storage Temperature Range	T _{stg}	- 65 ~ + 125	°C

 * V⁺+0.5V must be 44V or less.

ELECTRICAL CHARACTERISTICS (DC CHARACTERISTICS)

 ($V^+=15V$, $V^-=-15V$, $GND=0V$)

PARAMETER	SYMBOL	CONDITIONS	TYP	MAX			UNIT	
			25°C	0°C	25°C	70°C		
Analog Signal Range	V_{ANALOG}		± 15		± 15	± 15	V	
On-state Resistance	R_{ON}	$V_{IN}=0.8V$ $V_D=10V$	50	100	100	125	Ω	
		$I_S=-1mA$ $V_D=-10V$	50	100	100	125		
Source-off Leakage Current	$I_S(off)$	$V_I=2.4V$	$V_S=14V, V_D=-14V$	0.01		5	100	nA
			$V_S=-14V, V_D=14V$	-0.02		-5	-100	
Drain-off Leakage Current	$I_D(off)$	$V_I=2.4V$	$V_D=14V, V_S=-14V$	0.01		5	100	nA
			$V_D=-14V, V_S=14V$	-0.02		-5	-100	
Drain-on Leakage Current	$I_D(on)$	$V_I=0.8V$	$V_D=V_S=14V$	0.1		5	200	nA
			$V_D=V_S=-14V$	-0.15		-5	-200	
Input Current	I_{IH}	$V_I=2.4V$	-0.0004		-1	-10	μA	
		$V_I=15V$	0.003		1	10		
	I_{IL}	$V_I=0V$	-0.0004		-1	-10		
Quiescent Current	I^+	$V_I=0$ or $2.4V$	0.9		2		mA	
	I^-		-0.3		-1			

6

SWITCHING CHARACTERISTICS

 ($V^+=15V$, $V^-=-15V$, $GND=0V$)

PARAMETER	SYMBOL	CONDITIONS	TYP	MAX			UNIT	
			25°C	0°C	25°C	70°C		
Turn-on Time	t_{on}	$R_L=1k\Omega$, $C_L=35pF$	480		600		ns	
Turn-off Time	t_{off}		370		450			
Charge Injection	Q	$C_L=1000pF$, $V_{GEN}=0V$, $R_{GEN}=0\Omega$	20				pC	
Source-Off Capacit.	$C_S(off)$	$f=100kHz$	5				pF	
Drain-Off Capacit.	$C_D(off)$							$V_S=0V, V_I=5V$
Channel-On Capacitance	$C_D(on)$ $+C_S(on)$							$V_D=0V, V_I=5V$
								$V_D=V_S=0V$, $V_I=0V$
Off Isolation	OIRR	$V_S=2V_{P-P}$, $f=100kHz$, $R_L=75\Omega$	70				dB	
Channel-to-channel Crosstalk	CCRR		90					



MEMO

[CAUTION]



The specifications on this databook are only given for information, without any guarantee as regards either mistakes or omissions. The application circuits in this databook are described only to show representative usages of the product and not intended for the guarantee or permission of any right including the industrial rights.

Looking for pricing, stock, or lifecycle information?

Click below to explore more details on WIN SOURCE:

-  [View NJU201AM on WIN SOURCE](#)
-  [NJRC Corporation/NJRC Information](#)

Optimize Your Supply Chain with WIN SOURCE Solutions

-  Global Sourcing Solution
-  Obsolete Management
-  Cost Control Management
-  Shortage Management
-  Alternative Solution
-  Excess Inventory Management