

2SK596S



ON Semiconductor®

www.onsemi.com

JFET

20V, 150 to 350 μ A, 1.0mS, N-Channel

Features

- Low output noise voltage : $V_{NO} = -110\text{dB}$ max ($V_{CC} = 4.5\text{V}$, $R_L = 1\text{k}\Omega$, $C_{in} = 15\text{pF}$, $V_{IN} = 0\text{V}$, A curve)
- Especially suited for use in condenser microphone for audio equipments and telephones
- Excellent transient characteristic
- Adoption of FBET process

Specifications

Absolute Maximum Ratings at $T_a = 25^\circ\text{C}$

Parameter	Symbol	Conditions	Ratings	Unit
Gate-to-Drain Voltage	V_{GDO}		-20	V
Gate Current	I_G		10	mA
Drain Current	I_D		1	mA
Allowable Power Dissipation	P_D		100	mW
Junction Temperature	T_j		150	$^\circ\text{C}$
Storage Temperature	T_{stg}		-55 to +150	$^\circ\text{C}$

Stresses exceeding those listed in the Maximum Ratings table may damage the device. If any of these limits are exceeded, device functionality should not be assumed, damage may occur and reliability may be affected.

Package Dimensions

unit : mm (typ)

7524-005

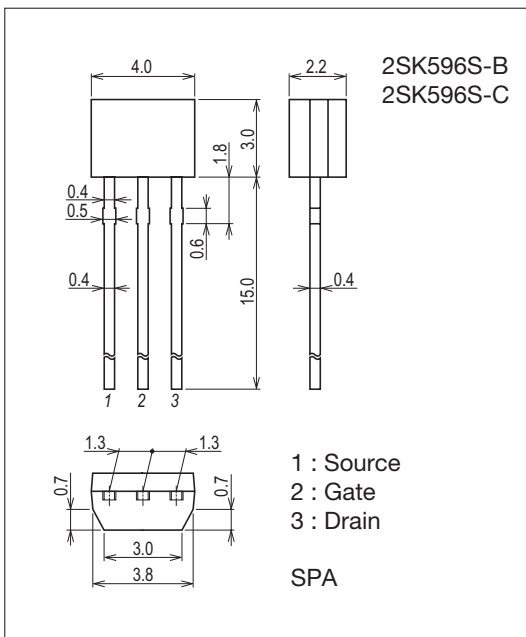

Product & Package Information

- Package : SPA
- JEITA, JEDEC : SC-72
- Minimum Packing Quantity : 500 pcs./bag

Marking

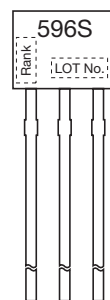

Electrical Connection

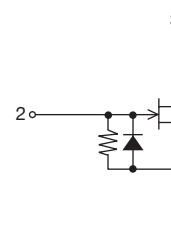

ORDERING INFORMATION

See detailed ordering and shipping information on page 2 of this data sheet.

2SK596S

Electrical Characteristics at Ta=25°C

Parameter	Symbol	Conditions	Ratings				Unit
			Rank	min	typ	max	
Gate-to-Drain Breakdown Voltage	$V_{(BR)GDO}$	$I_G = -100\mu A$		-20			V
Cutoff Voltage	$V_{GS(off)}$	$V_{DS} = 5V, I_D = 1\mu A$			-0.5	-1.0	V
Drain Current	I_{DSS}^*	$V_{DS} = 5V, V_{GS} = 0V$	B	150		240	μA
			C	210		350	
Forward Transfer Admittance	$ y_{fs} $	$V_{DS} = 5V, V_{GS} = 0V, f = 1kHz$		0.4	1.0		mS
Input Capacitance	C_{iss}	$V_{DS} = 5V, V_{GS} = 0V, f = 1MHz$			4.1		pF
Reverse Transfer Capacitance	C_{rss}	$V_{DS} = 5V, V_{GS} = 0V, f = 1MHz$			0.88		pF
[Ta=25°C, VCC=4.5V, RL=1kΩ, Cin=15pF, See specified Test Circuit.]							
Voltage Gain	G_V	$V_{IN} = 10mV, f = 1kHz$			-3.0		dB
Reduced Voltage Characteristic	ΔG_{VV}	$V_{IN} = 10mV, f = 1kHz, V_{CC} = 4.5V \rightarrow 1.5V$			-1.0	-3.5	dB
Frequency Characteristic	ΔG_{vf}	$f = 1kHz \rightarrow 110Hz$				-1.0	dB
Total Harmonic Distortion	THD	$V_{IN} = 30mV, f = 1kHz$			1.2		%
Output Noise Voltage	V_{NO}	$V_{IN} = 0V, A \text{ curve}$				-110	dB

* : The 2SK596S is classified by I_{DSS} as follows : (unit : μA)

Rank	B	C
I_{DSS}	150 to 240	210 to 350

Product parametric performance is indicated in the Electrical Characteristics for the listed test conditions, unless otherwise noted. Product performance may not be indicated by the Electrical Characteristics if operated under different conditions.

Test Circuit

Voltage Gain

Frequency Characteristic

Harmonic Distortion

Reduced Voltage Characteristic

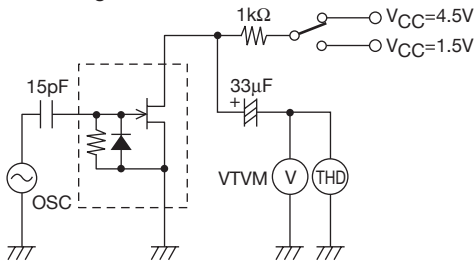

ORDERING INFORMATION

Device	Package	Shipping	memo
2SK596S-B	SPA	500pcs./bag	Pb-Free
2SK596S-C	SPA	500pcs./bag	

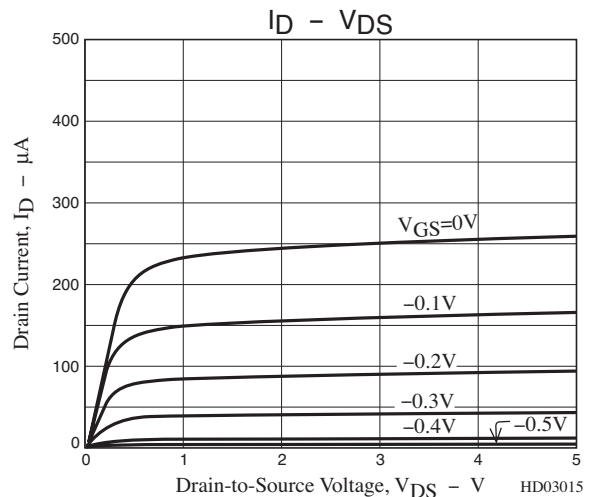
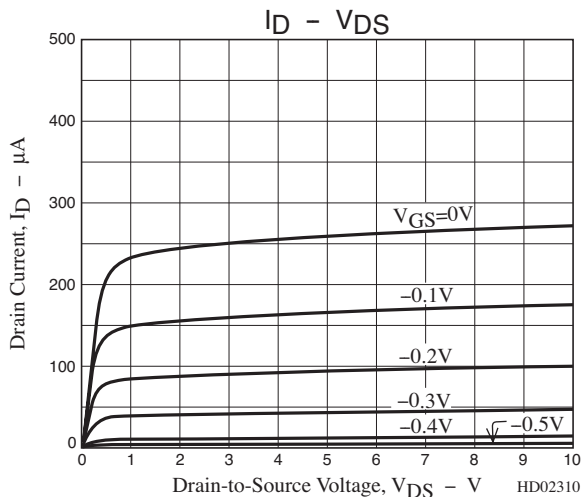

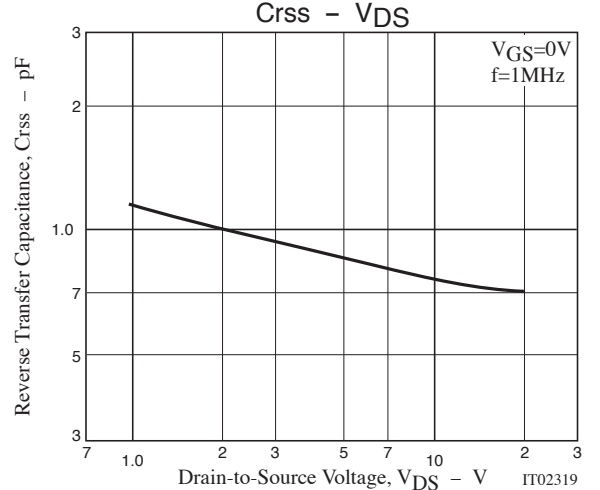
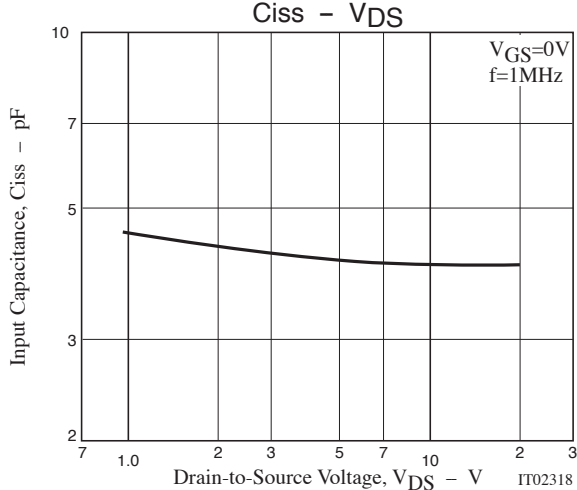
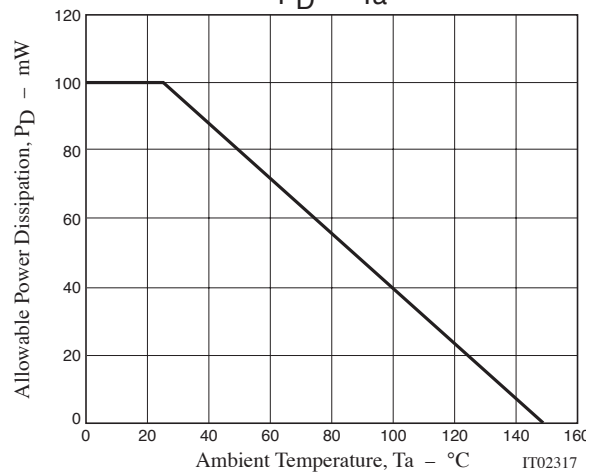
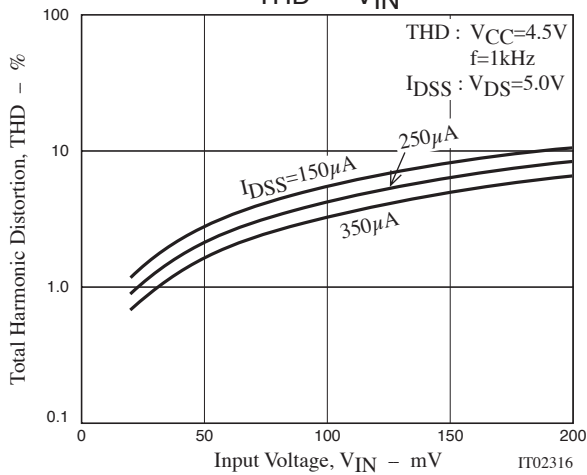
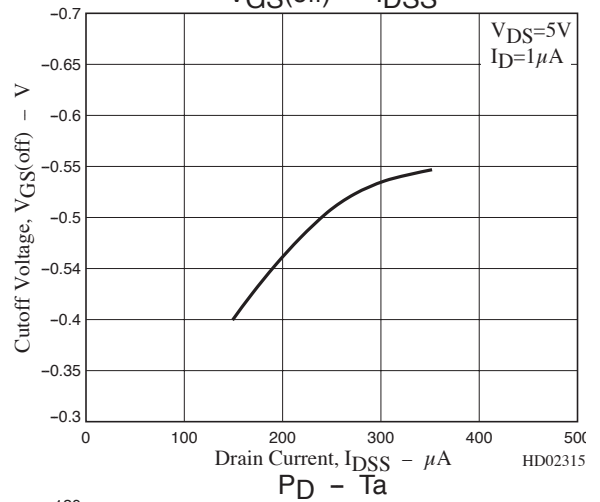
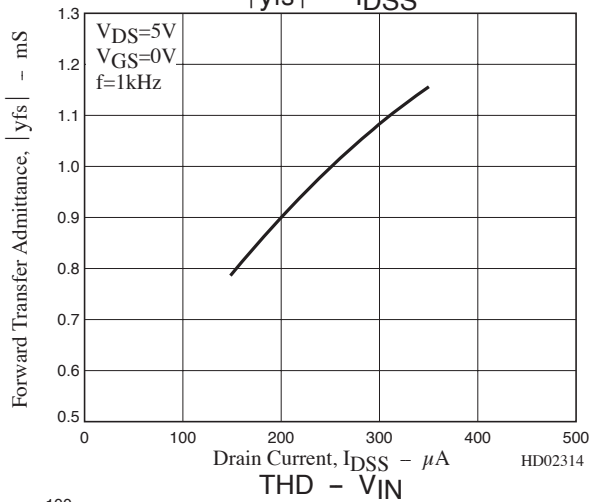
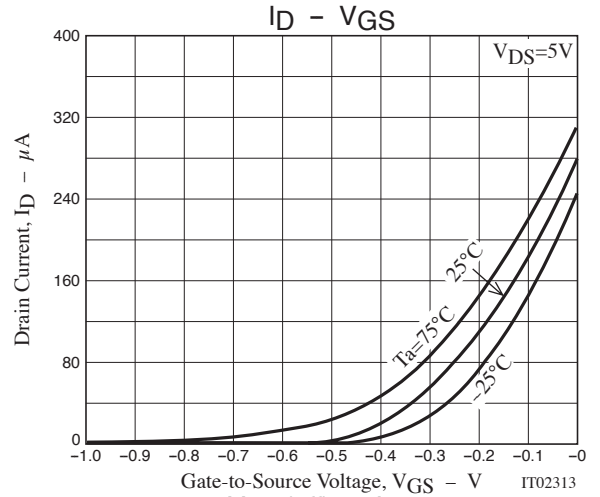
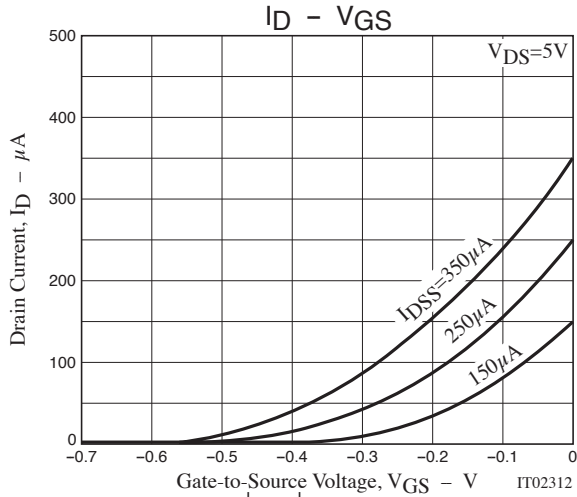

2SK596S

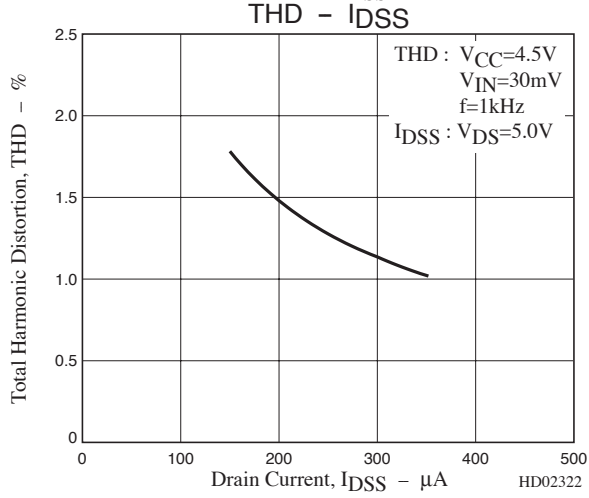
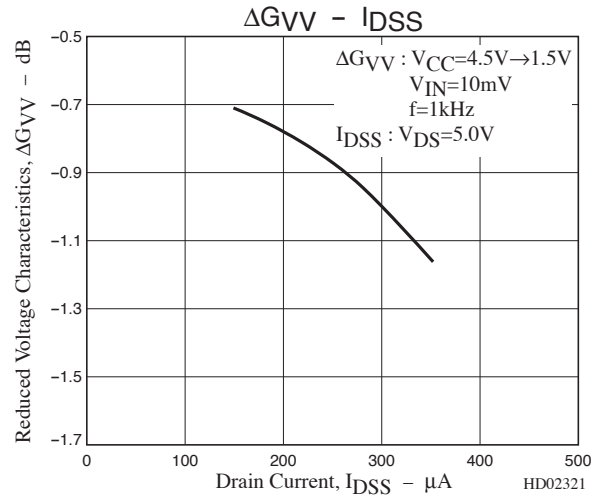
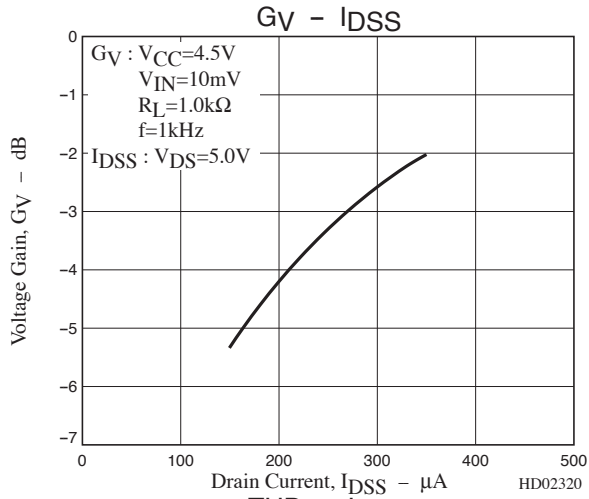

Outline Drawing

2SK596S-B, 2SK596S-C

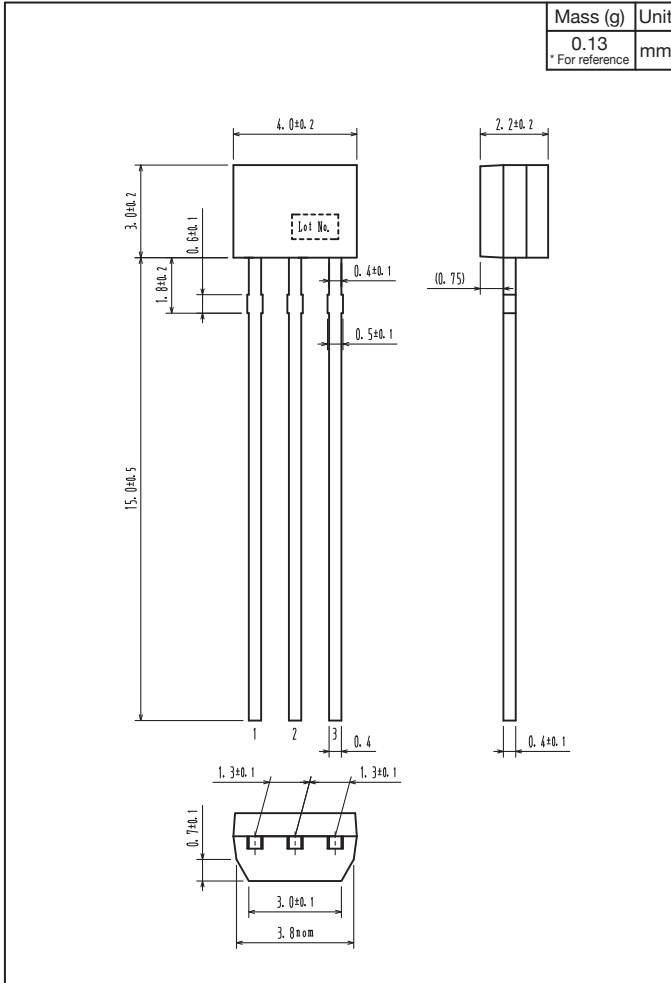

ON Semiconductor and the ON logo are registered trademarks of Semiconductor Components Industries, LLC (SCILLC) or its subsidiaries in the United States and/or other countries. SCILLC owns the rights to a number of patents, trademarks, copyrights, trade secrets, and other intellectual property. A listing of SCILLC's product/patent coverage may be accessed at www.onsemi.com/site/pdf/Patent-Marking.pdf. SCILLC reserves the right to make changes without further notice to any products herein. SCILLC makes no warranty, representation or guarantee regarding the suitability of its products for any particular purpose, nor does SCILLC assume any liability arising out of the application or use of any product or circuit, and specifically disclaims any and all liability, including without limitation special, consequential or incidental damages. "Typical" parameters which may be provided in SCILLC data sheets and/or specifications can and do vary in different applications and actual performance may vary over time. All operating parameters, including "Typicals" must be validated for each customer application by customer's technical experts. SCILLC does not convey any license under its patent rights nor the rights of others. SCILLC products are not designed, intended, or authorized for use as components in systems intended for surgical implant into the body, or other applications intended to support or sustain life, or for any other application in which the failure of the SCILLC product could create a situation where personal injury or death may occur. Should Buyer purchase or use SCILLC products for any such unintended or unauthorized application, Buyer shall indemnify and hold SCILLC and its officers, employees, subsidiaries, affiliates, and distributors harmless against all claims, costs, damages, and expenses, and reasonable attorney fees arising out of, directly or indirectly, any claim of personal injury or death associated with such unintended or unauthorized use, even if such claim alleges that SCILLC was negligent regarding the design or manufacture of the part. SCILLC is an Equal Opportunity/Affirmative Action Employer. This literature is subject to all applicable copyright laws and is not for resale in any manner.

Looking for pricing, stock, or lifecycle information?

Click below to explore more details on WIN SOURCE:

- [View 2SK596S-B on WIN SOURCE](#)
- [ON Semiconductor Information](#)

Optimize Your Supply Chain with WIN SOURCE Solutions

- ✓ Global Sourcing Solution
- ✓ Obsolete Management
- ✓ Cost Control Management
- ✓ Shortage Management
- ✓ Alternative Solution
- ✓ Excess Inventory Management