

LOW-NOISE DUAL OPERATIONAL AMPLIFIER

■ GENERAL DESCRIPTION

The NJM5532 is a high performance dual low noise operational amplifier. Compared to the standard dual operational amplifiers, such as the NJM1458, it shows better noise performance, improved output drive capability, and considerably higher small-signal and power bandwidths. It is compensated internally for voltage follower circuit. This makes the device especially suitable for application in high quality and professional audio equipment, instrumentation, control circuits, and telephone channel amplifiers.

If very low noise characteristic is of prime importance, it is recommended D-Rank type products (NJM5532DD/LD/MD). These have specified maximum limits for equivalent input noise voltage.

■ PACKAGE OUTLINE

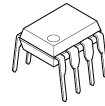

NJM5532D
(DIP8)

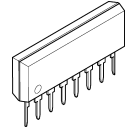

NJM5532L
(SIP8)



NJM5532M
(DMP8)

■ FEATURES

- Operating Voltage $\pm 3V \sim \pm 22V$
- Small Signal Bandwidth 10MHz typ.
- Output Drive Capability 600 Ω , 10Vrms typ.
- Input Noise Voltage 5nV/ $\sqrt{\text{Hz}}$ typ.
- Power Bandwidth 140kHz typ.
- Slew Rate 8V/ μs typ.
- Bipolar Technology
- Package Outline DIP8, DMP8, SIP8

■ PIN CONFIGURATION

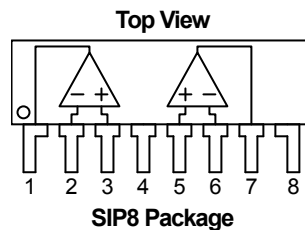
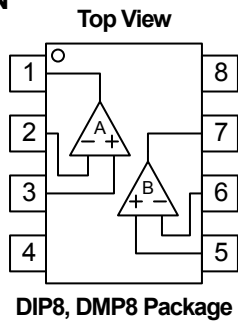

PIN FUNCTION

- 1.A OUTPUT
- 2.A -INPUT
- 3.A +INPUT
- 4.V⁻
- 5.B +INPUT
- 6.B -INPUT
- 7.B OUTPUT
- 8.V⁺

■ EQUIVALENT CIRCUIT (1/2 Shown)

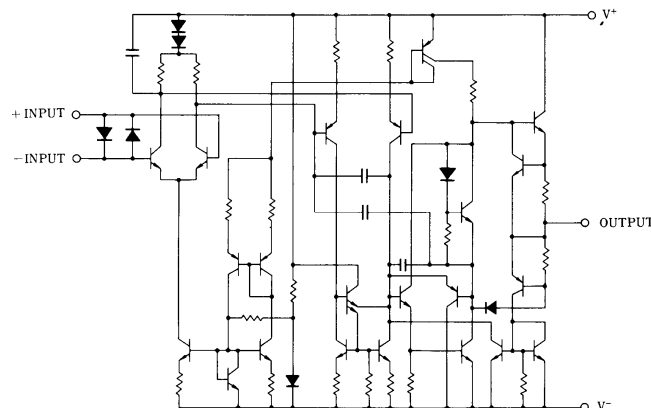

NJM5532

■ ABSOLUTE MAXIMUM RATINGS (Ta=25°C)

| PARAMETER | SYMBOL | RATING | UNIT |
|----------------------------------|-------------------|---|------|
| Supply Voltage | V ⁺ /V | ±22 | V |
| Common Mode Input Voltage Range | V _{ICM} | V ⁺ /V | V |
| Differential Input Voltage Range | V _{ID} | ±0.5 | V |
| Power Dissipation | P _D | DIP8 : 500 DMP8 : 600(Note1) SIP8 : 800 | mW |
| Operating Temperature Range | T _{opr} | -20~+75 | °C |
| Storage Temperature Range | T _{stg} | -40~+125 | °C |

(Note1) On the cermic PCB (10x20x0.635mm)

■ RECOMMENDED OPERATING VOLTAGE (Ta=25°C)

| PARAMETER | SYMBOL | RATING | UNIT |
|----------------|-------------------|--------|------|
| Supply Voltage | V ⁺ /V | ±3~±22 | V |

■ ELECTRICAL CHARACTERISTICS (V⁺/V=±15V, Ta=25°C, unless otherwise noted.)

● DC ELECTRICAL CHARACTERISTICS

| PARAMETER | SYMBOL | TEST CONDITION | MIN. | TYP. | MAX. | UNIT |
|---------------------------------|------------------|--|------|------|------|------|
| Input Offset Voltage | V _{IO} | R _S ≤10kΩ | - | 0.5 | 4 | mV |
| Input Offset Current | I _{IO} | | - | 10 | 150 | nA |
| Input Bias Current | I _B | | - | 200 | 800 | nA |
| Supply Current | I _{CC} | R _L =∞ | - | 9 | 16 | mA |
| Common Mode Input Voltage Range | V _{ICM} | | ± 12 | ± 13 | - | V |
| Common Mode Rejection Ratio | CMR | R _S ≤10kΩ | 70 | 100 | - | dB |
| Supply Voltage Rejection Ratio | SVR | R _S ≤10kΩ | 80 | 100 | - | dB |
| Voltage Gain1 | A _{V1} | R _L ≥2kΩ, V _O =±10V | 88 | 100 | - | dB |
| Voltage Gain2 | A _{V2} | R _L ≥600Ω, V _O =±10V | 83.5 | 94 | - | dB |
| Maximum Output Voltage1 | V _{OM1} | R _L ≥600Ω | ± 12 | ± 13 | - | V |
| Maximum Output Voltage2 | V _{OM2} | R _L ≥600Ω, V ⁺ /V=±18V | ± 15 | ± 16 | - | V |
| Input Resistance | R _{IN} | | 30 | 300 | - | kΩ |
| Short Circuit Output Current | I _{OS} | | - | 38 | - | mA |

● AC ELECTRICAL CHARACTERISTICS

| PARAMETER | SYMBOL | TEST CONDITION | MIN. | TYP. | MAX. | UNIT |
|--------------------------------|-----------------|---|------|------|------|--------|
| Output Resistance | R _O | A _V =30dB, f=10kHz, R _L =600Ω | - | 0.3 | - | Ω |
| Overshoot | | A _V =1, V _{IN} =100mV _{PP} , R _L =100pF, R _L =600Ω | - | 10 | - | % |
| Voltage Gain | A _V | f=10kHz | - | 67 | - | dB |
| Slew Rate | SR | | - | 8 | - | V/μs |
| Gain Bandwidth Product | GB | C _L =100pF, R _L =600Ω | - | 10 | - | MHz |
| Power Bandwidth | W _{PG} | V _O =±10V | - | 140 | - | kHz |
| | W _{PG} | V _O =±14V, R _L =600Ω, V ⁺ /V=±18V | - | 100 | - | kHz |
| Equivalent Input Noise Voltage | e _n | f _O =30Hz | - | 8 | - | nV/√Hz |
| | e _n | f _O =1kHz | - | 5 | - | nV/√Hz |
| Equivalent Input Noise Current | i _n | f _O =30Hz | - | 2.7 | - | pA/√Hz |
| | i _n | f _O =1kHz | - | 0.7 | - | pA/√Hz |
| Channel Separation | CS | f=1kHz, R _S =5kΩ | - | 110 | - | dB |

■ ELECTRICAL CHARACTERISTICS (D-ranktype(Note2), V⁺/V=±15V, Ta=25°C, unless otherwise noted.)

| PARAMETER | SYMBOL | TEST CONDITION | MIN. | TYP. | MAX. | UNIT |
|--------------------------------|-----------------|-----------------------------|------|------|------|-------|
| Equivalent Input Noise Voltage | V _{NI} | RIAA, R _S =2.2kΩ | - | - | 1.4 | μVrms |

(Note2) D-rank type is a Equivalent Input Noise Voltage selected product.

■ TYPICAL CHARACTERISTICS

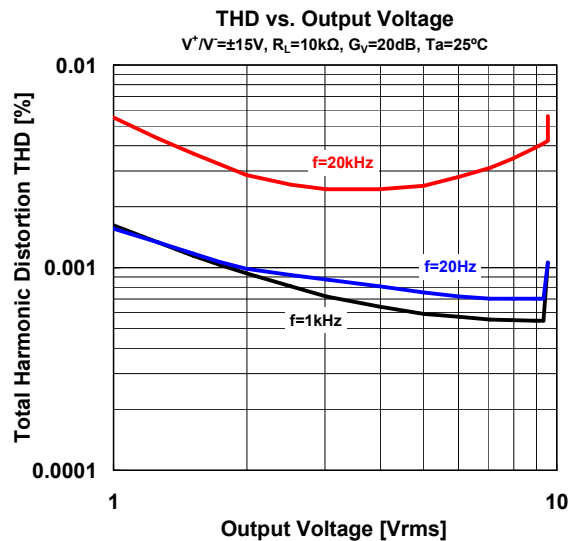
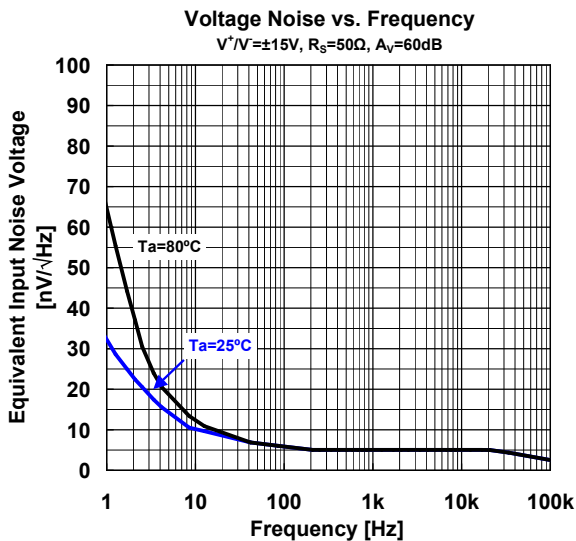
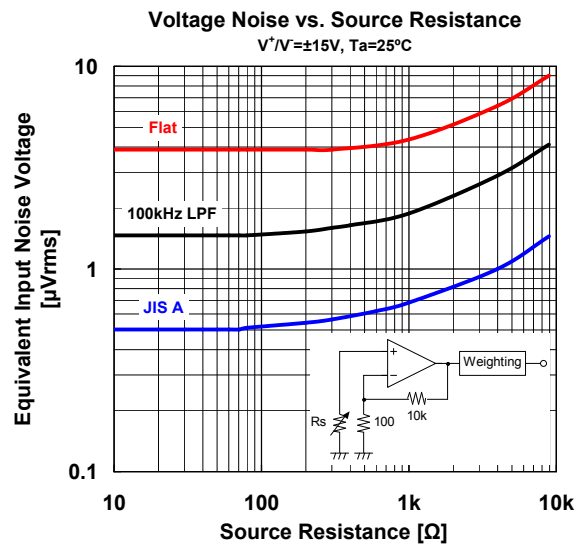
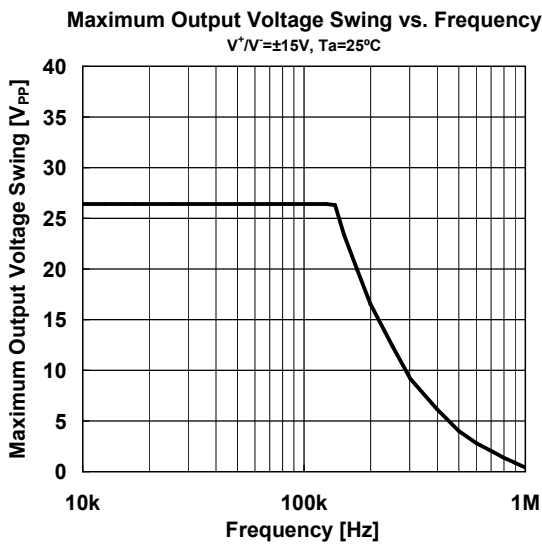
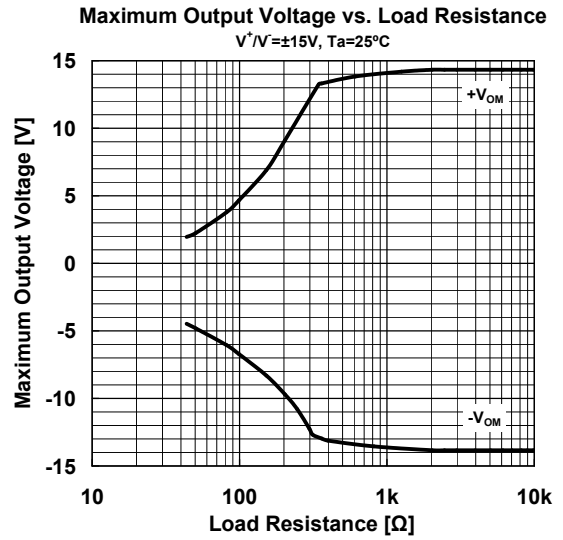
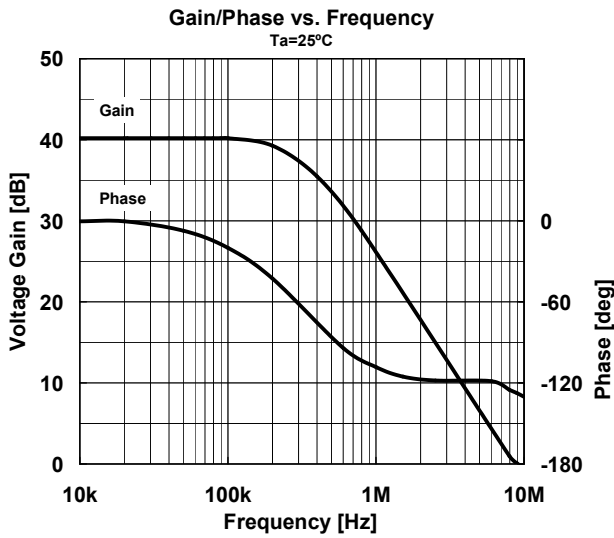

■ TYPICAL CHARACTERISTICS

Supply Current vs. Supply Voltage

$T_a=25^\circ\text{C}$

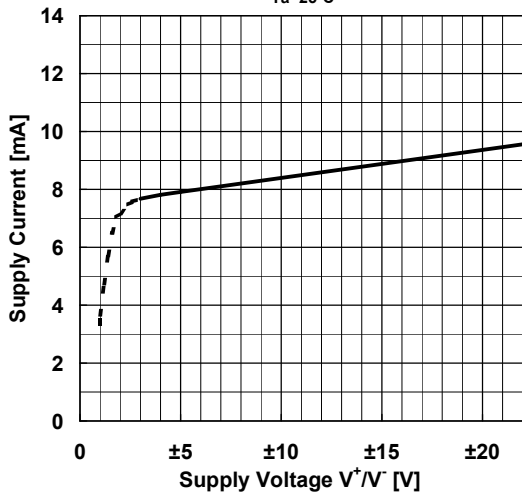

Supply Current vs. Temperature

$V^+/V^-=\pm 15\text{V}$

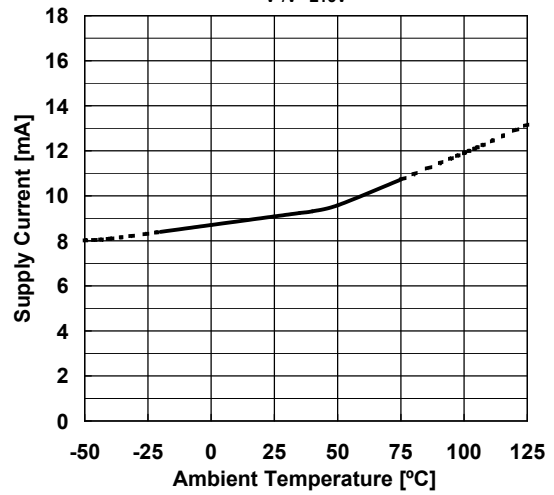

Input Offset Voltage vs. Temperature

$V^+/V^-=\pm 15\text{V}$

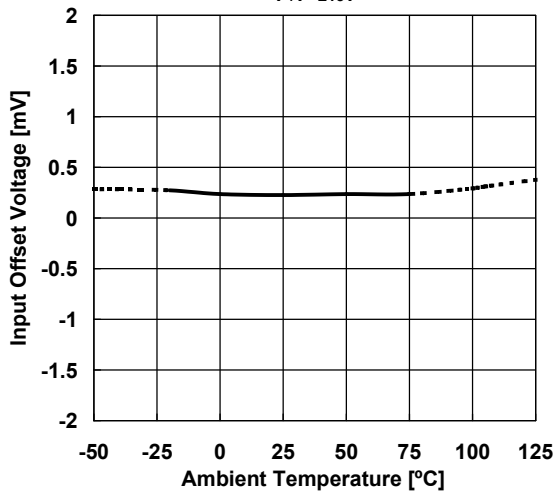

Input Bias Current vs. Temperature

$V^+/V^-=\pm 15\text{V}$

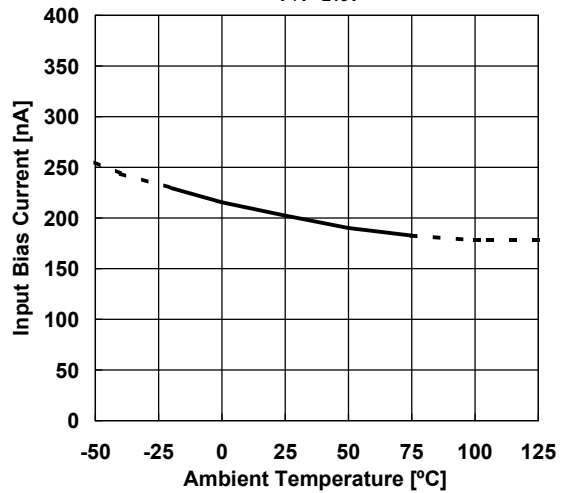

Maximum Output Voltage vs. Supply Voltage

$R_L=2\text{k}\Omega, T_a=25^\circ\text{C}$

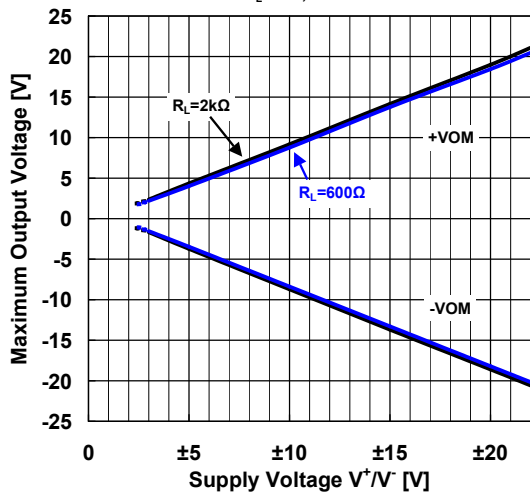

Maximum Output Voltage vs. Temperature

$V^+/V^-=\pm 15\text{V}, R_L=600\Omega$

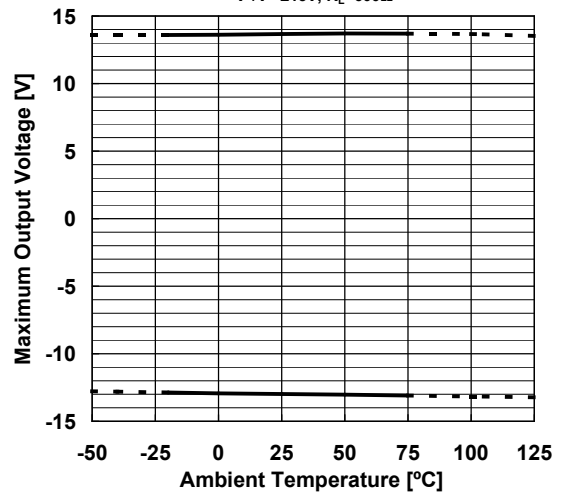

■ TEST CIRCUIT

Noise Voltage (RIAA) measurement circuit

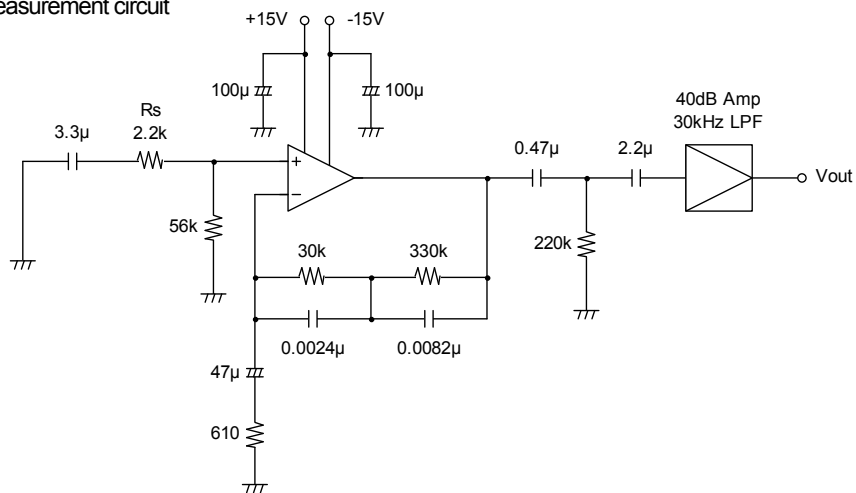

■ NOTICE

When used in voltage follower circuit, put a current limit resistor into non-inverting input terminal in order to avoid inside input diode destruction when the power supply is turned on. (ref.Fig.1)

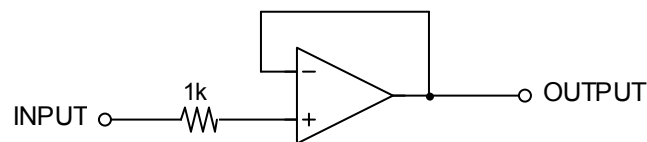



(Fig.1)

[CAUTION]
 The specifications on this databook are only given for information, without any guarantee as regards either mistakes or omissions. The application circuits in this databook are described only to show representative usages of the product and not intended for the guarantee or permission of any right including the industrial rights.

Looking for pricing, stock, or lifecycle information?

Click below to explore more details on WIN SOURCE:

-  [View NJM5532CG-TE2 on WIN SOURCE](#)
-  [NJR Corporation/NJRC Information](#)

Optimize Your Supply Chain with WIN SOURCE Solutions

-  Global Sourcing Solution
-  Obsolete Management
-  Cost Control Management
-  Shortage Management
-  Alternative Solution
-  Excess Inventory Management