

LOW POWER NARROW BAND FM IF

■ GENERAL DESCRIPTION

The **NJM3359** is a low power narrow band FM detector integrated circuit. for FM dual conversion of communication equipment. The **NJM3359** includes oscillator, limiting amplifier, AFC circuit, quadrature detect, operational amplifier, squelch circuit, scan-control and muting switch.

The **NJM3359** is a circuit of **NJM3357** plus one stage limiting IF amplifier and AFC output terminal.

■ FEATURES

- Low Operating Current (3.6mA typ@V⁺=6V)
- Input Limiting Voltage (2.0μVrms typ@-3dB)
- Minimum other parts.
- Package Outline DIP18
- Bipolar Technology

■ RECOMMENDED OPERATIONAL CODITION

- Operating Voltage 4 to 9V

■ PIN CONFIGURATION

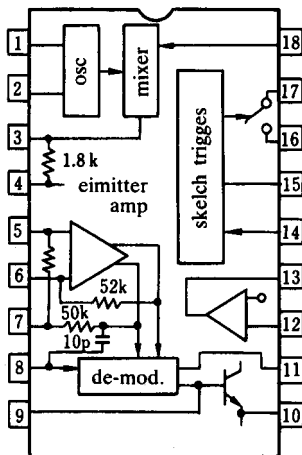

NJM3359D

PIN FUNCTION

Pin No.

- | | |
|-----------------------|-------------------------|
| 1. crystal | 10. de-modulator output |
| 2. crystal | 11. AFC |
| 3. mixer output | 12. filter input |
| 4. V ⁺ | 13. filter output |
| 5. limiter input | 14. skelch input |
| 6. de-coupling | 15. scan, control |
| 7. de-coupling | 16. audio muting |
| 8. detector input | 17. GND |
| 9. de-modulator input | 18. RF input |

■ PACKAGE OUTLINE

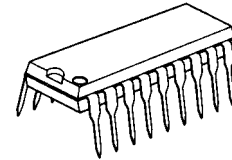

NJM3359D

NJM3359

■ ABSOLUTE MAXIMUM RATINGS

($T_a=25^{\circ}\text{C}$)

PARAMETER	SYMBOL	RATINGS	UNIT
Supply Voltage	V^+	12	V
Input Voltage	V18	1.0	V _{rms}
Muting Function	V16	-0.7 to 12	V _{PK}
Operating Temperature Range	T_{opr}	-40 to 85	$^{\circ}\text{C}$
Storage Temperature Range	T_{stg}	-40 to 125	$^{\circ}\text{C}$

■ ELECTRICAL CHARACTERISTICS

($V^+=6\text{V}$, $f_o=10.7\text{MHz}$, $\Delta f=\pm 3.0\text{kHz}$, $f_{mod}=1.0\text{kHz}$, $T_a=25^{\circ}\text{C}$)

PARAMETER	PIN	MIN.	TYP.	MAX.	UNIT
Operating Current	PIN 4,8				
Squelch OFF		-	3.6	6.0	mA
Squelch ON		-	5.4	7.0	mA
Input Sensitivity (S / N : 20dB)		-	8.0	-	μVrms
Input Limiting Voltage (-3dB)		-	2.0	-	μVrms
Mixer Voltage Gain	PIN 18 - PIN 3 Open	-	33	-	dB
Mixer Intercept Point	50 Ω input	-	-1.0	-	dBm
Mixer Input Resistance		-	3.6	-	k Ω
Mixer Input Capacitance		-	2.2	-	pF
Recovered Audio Output Voltage	PIN 10, $V_{IN}=1.0\text{mVrms}$	450	700	-	mVrms
Detector Center Frequency Slope	PIN 10	-	0.3	-	V / kHz
AFC Center Frequency Slope	PIN 11, $R_L=\infty$	-	12	-	V / kHz
Filter Gain	$f_{IN}=10\text{kHz}$, $V_{IN}=5\text{mV}$	40	51	-	dB
Squelch Threshold Voltage	PIN 14, 10k Ω	-	0.62	-	Vdc
Scan Control Current	PIN 15				
	PIN 14 - High	-	0.01	1.0	μA
	- Low	2.0	2.4	-	mA
Mute Switch Impedance	PIN 16 - GND				
	PIN14 - High	-	5.0	10	Ω
	- Low	-	1.5	-	M Ω

■ TYPICAL CHARACTERISTICS

Input - Output

($V^+ = 6.0V$, $f_{in} = 10.7MHz$, $\Delta f = \pm 3kHz$,
 $f_{mod} = 1kHz$)

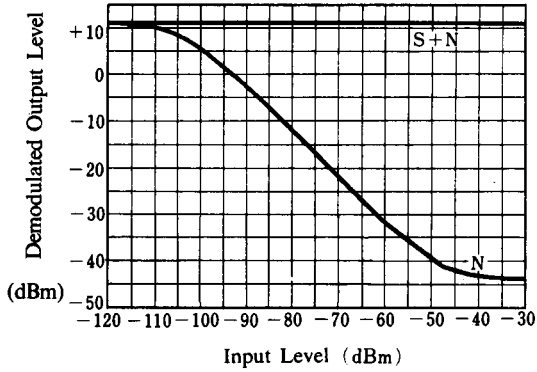

Local OSC Frequency

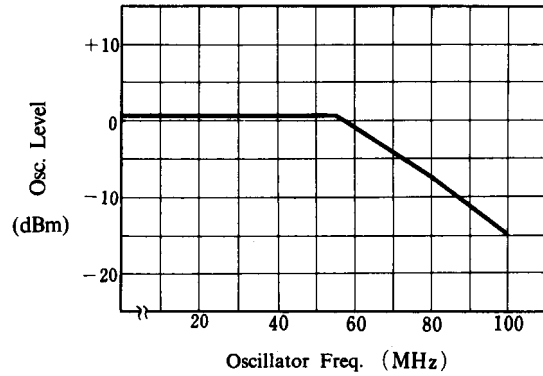

Mixer Gain vs. Input Frequency

(2nd IF = 455kHz, adjust Local OSC
frequency)

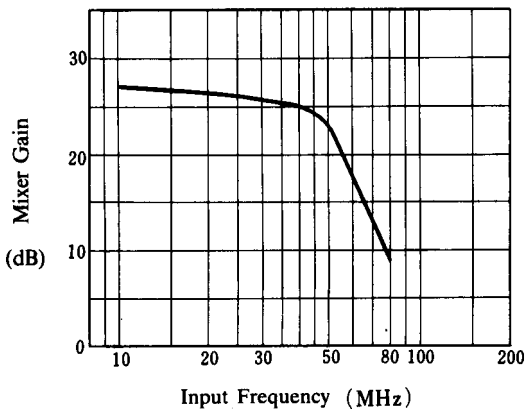

AFC Characteristics

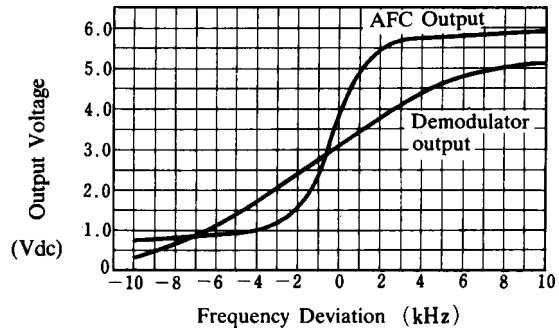

Demodulator Output

($f_{in} = 10.7MHz$, $f_{mod} = 1kHz$, $\Delta f = \pm 3kHz$,
 $V_{in} = 1mV_{rms}$)

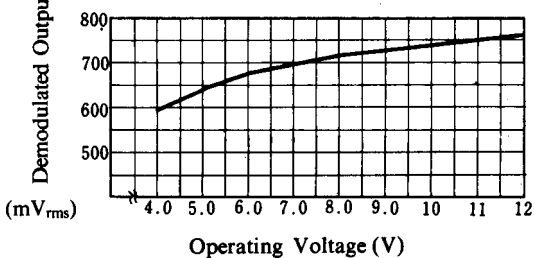

Temperature Characteristics

($V^+ = 6.0V$, $f_{in} = 10.7MHz$, $f_{mod} = 1kHz$,
 $\Delta f = \pm 3kHz$, $S/N : V_{in} = 1mV_{rms}$,
Sensitivity : $V_{in} = 8.0\mu V_{rms}$)

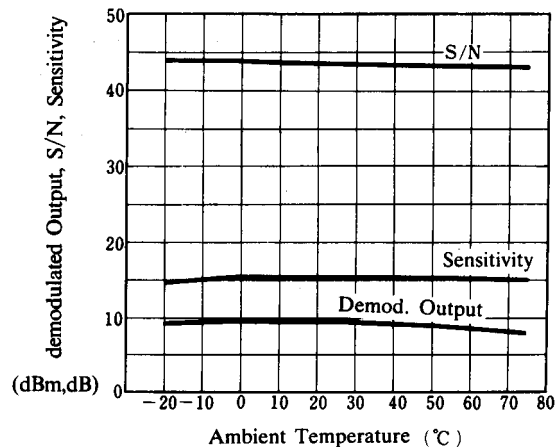

[CAUTION]

The specifications on this databook are only given for information, without any guarantee as regards either mistakes or omissions. The application circuits in this databook are described only to show representative usages of the product and not intended for the guarantee or permission of any right including the industrial rights.

Looking for pricing, stock, or lifecycle information?

Click below to explore more details on WIN SOURCE:

- ⊖ [View NJM3359D-#ZZZB on WIN SOURCE](#)
- ⊖ [NJR Corporation/NJRC Information](#)

Optimize Your Supply Chain with WIN SOURCE Solutions

- ✓ Global Sourcing Solution
- ✓ Obsolete Management
- ✓ Cost Control Management
- ✓ Shortage Management
- ✓ Alternative Solution
- ✓ Excess Inventory Management