

SINGLE-SUPPLY DUAL OPERATIONAL AMPLIFIER

■ GENERAL DESCRIPTION

The NJM2904 consists of two independent, high gain, internally frequency compensated operation amplifiers, which were designed specifically to operate from a single power supply over a wide range of voltages. Operation from split power supplies is also possible and the low power supply current drain is independent of the magnitude of the power supply voltage.

Application areas include transducer amplifiers, DC gain blocks, and all the conventional op amp circuits, which now can be more easily implemented in single power supply systems. For example, the NJM2904 can be directly operated off of the standard +5V power supply voltage, which is used in digital systems and will easily provide the required interface electronics without requiring the additional $\pm 15V$ power supplies.

■ FEATURES

- Single Supply
- Operating Voltage (+3V~+32V)
- Low Operating Current (0.7mA typ.)
- Slew Rate (0.5V/ μ s typ.)
- Bipolar Technology
- Package Outline DIP8, DMP8, EMP8, SSOP8, TVSP8, SIP8

■ PACKAGE OUTLINE

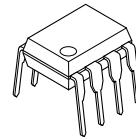

NJM2904D



NJM2904M



NJM2904E



NJM2904V



NJM2904RB1

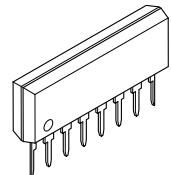

NJM2904L

■ PIN CONFIGURATION

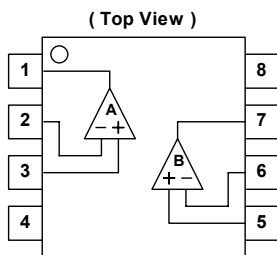

NJM2904D, NJM2904M
NJM2904E, NJM2904V
NJM2904RB1

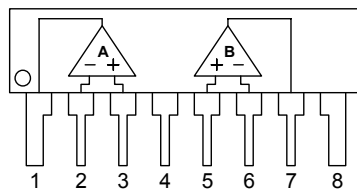

NJM2904L

PIN FUNCTION

1. A OUTPUT
2. A -INPUT
3. A +INPUT
4. GND
5. B +INPUT
6. B -INPUT
7. B OUTPUT
8. V⁺

■ EQUIVALENT CIRCUIT (1/2 Shown)

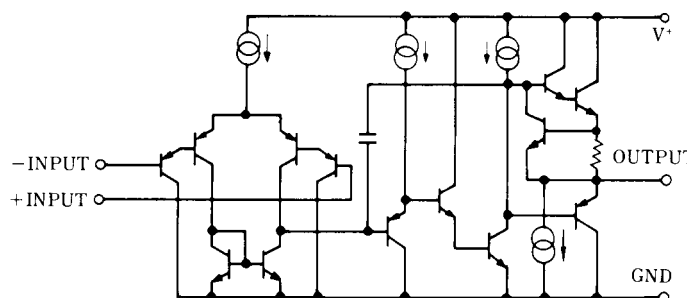

NJM2904

■ ABSOLUTE MAXIMUM RATINGS

(Ta=25°C)

PARAMETER	SYMBOL	RATINGS	UNIT
Supply Voltage	$V^+(V^-/V)$	32 (or ± 16)	V
Differential Input Voltage	V_{ID}	32	V
Input Voltage	V_{IC}	-0.3~+32	V
Power Dissipation	P_D	(DIP8) 500 (DMP8) 300 (EMP8) 300 (SSOP8) 300 (TVSP8) 320 (SIP8) 800	mW
Operating Temperature Range	T_{opr}	-40~+85	°C
Storage Temperature Range	T_{stg}	-50~+125	°C

■ ELECTRICAL CHARACTERISTICS

(Ta=25°C, $V^+=5V$)

PARAMETER	SYMBOL	TEST CONDITION	MIN.	TYP.	MAX.	UNIT
Input Offset Voltage	V_{IO}	$R_S=0\Omega$	-	2	7	mV
Input Offset Current	I_{IO}		-	5	50	nA
Input Bias Current	I_B		-	25	250	nA
Large Signal Voltage Gain	A_V	$R_L \geq 2k\Omega$	-	100	-	dB
Maximum Output Voltage Swing	V_{OM}	$R_L=2k\Omega$	3.5	-	-	V
Input Common Mode Voltage Range	V_{ICM}		0~3.5	-	-	V
Common Mode Rejection Ratio	CMR		-	85	-	dB
Supply Voltage Rejection Ratio	SVR		-	100	-	dB
Output Source Current	I_{SOURCE}	$V_{IN}^+=1V, V_{IN}^-=0V$	20	30	-	mA
Output Sink Current	I_{SINK}	$V_{IN}^+=0V, V_{IN}^-=1V$	8	20	-	mA
Channel Separation	CS	$f=1k\sim 20kHz$, Input Referred	-	120	-	dB
Operating Current	I_{CC}	$R_L=\infty$	-	0.7	1.2	mA
Slew Rate	SR	$V^+/V^-=\pm 15V$	-	0.5	-	V/ μs
Unity Gain Bandwidth	f_T	$V^+/V^-=\pm 15V$	-	0.6	-	MHz

■ TYPICAL CHARACTERISTICS

Operating Current vs. Operating Voltage

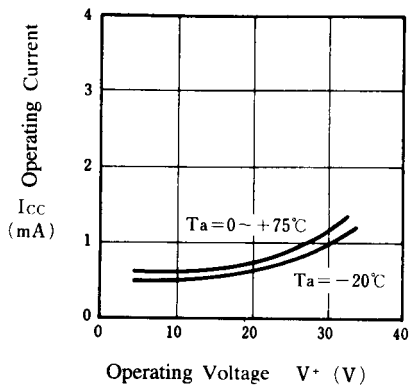

Input Bias Current vs. Operating Voltage

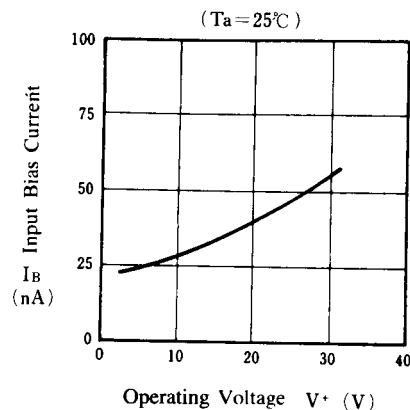

Channel Separation vs. Frequency

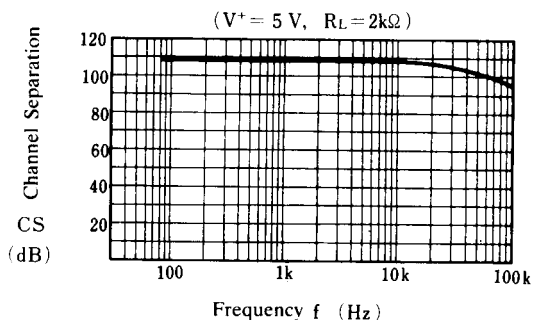

Voltage Gain vs. Operating Voltage

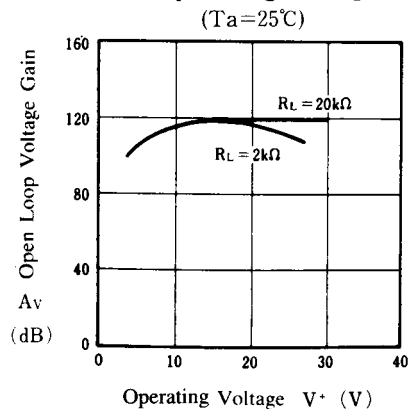

Maximum Output Voltage Swing vs. Frequency

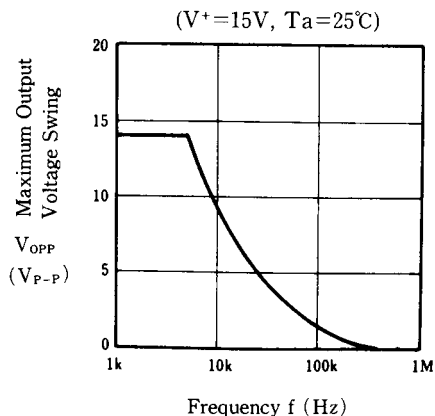

Open Loop Voltage Gain vs. Frequency

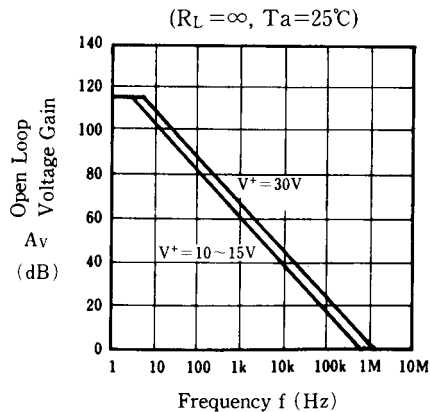

■ TYPICAL CHARACTERISTICS

Maximum Output Voltage Swing vs. Temperature

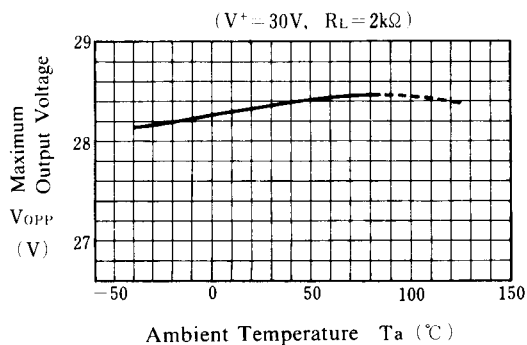

Operating Current vs. Temperature

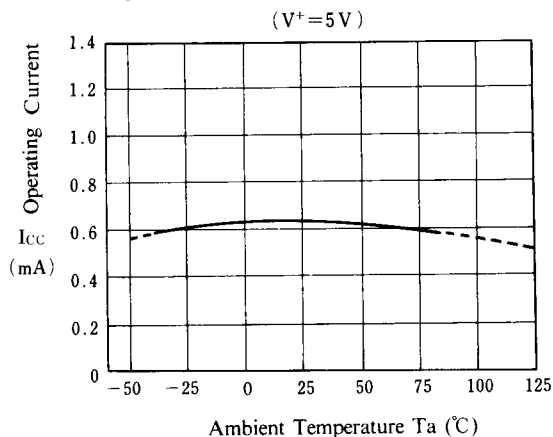

Input Offset Voltage vs. Temperature

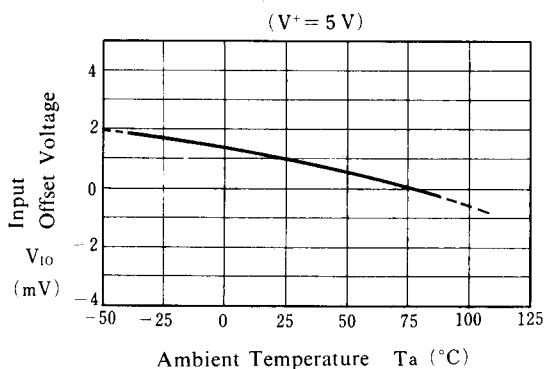

Input Bias Current vs. Temperature

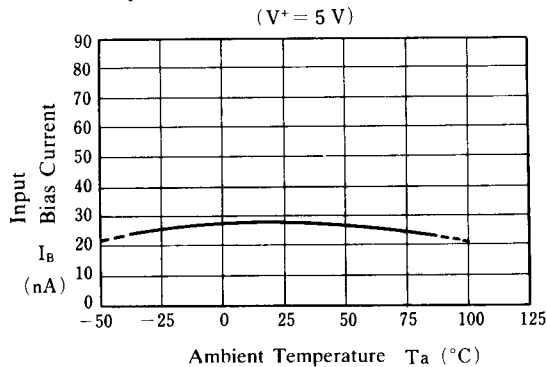

Output Voltage vs. Sink Current

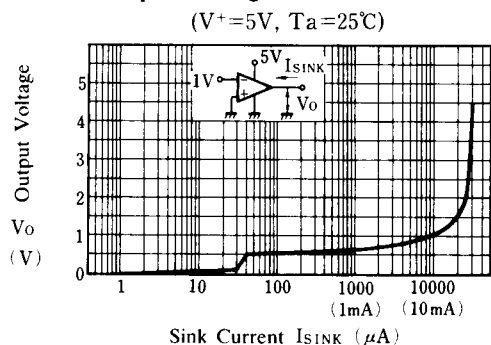

Source Current

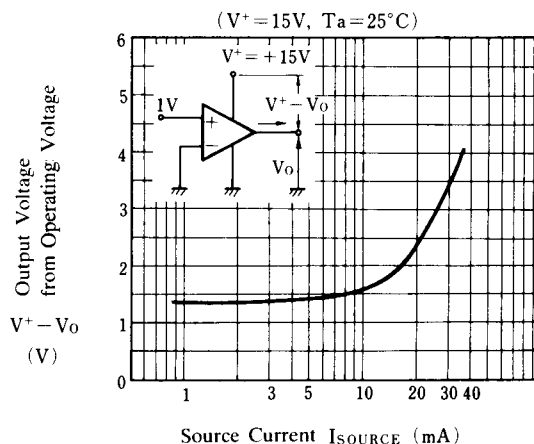

■ TYPICAL CHARACTERISTICS

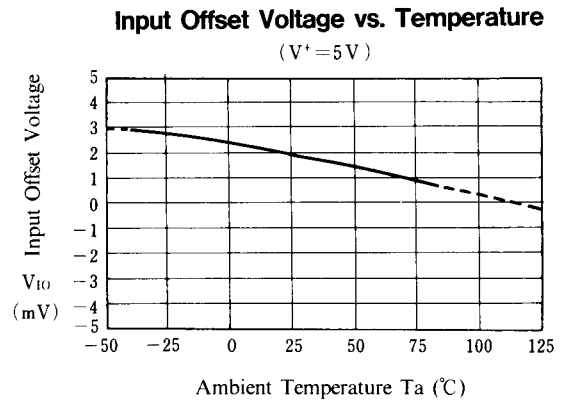
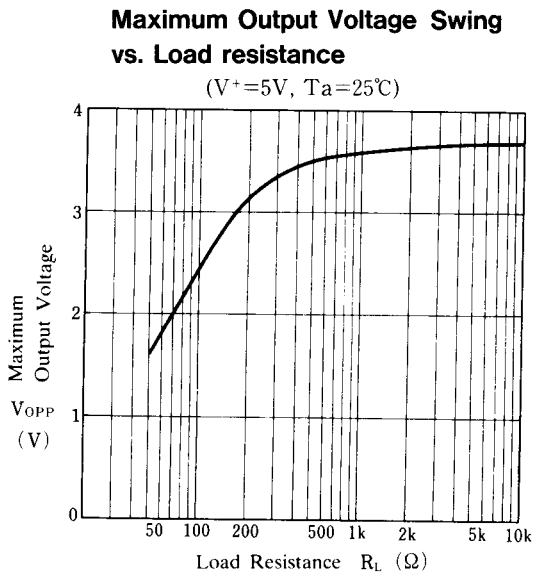
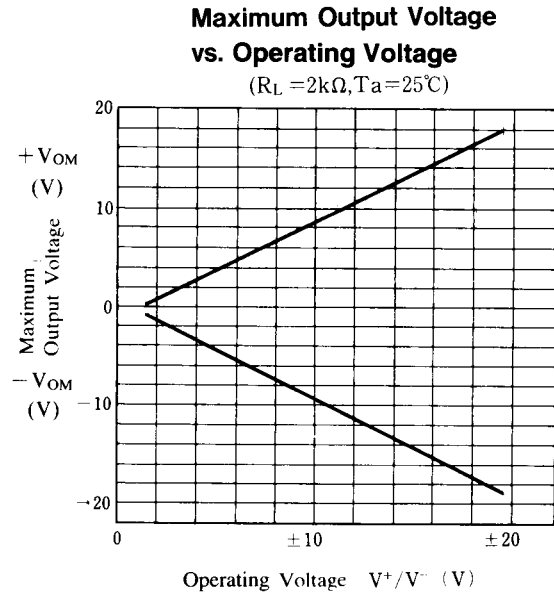
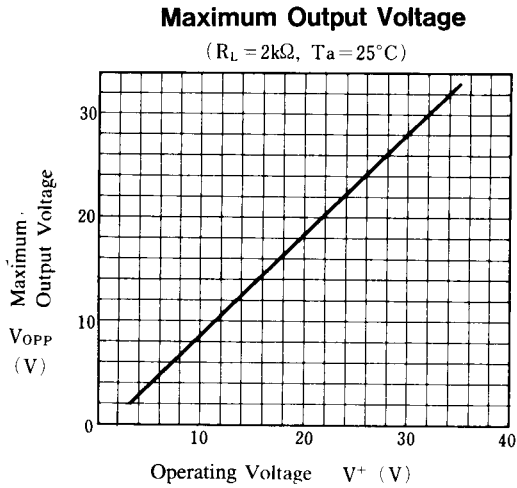

APPLICATION

Improvement of Cross-over Distortion
Equivalent circuit at the output stage

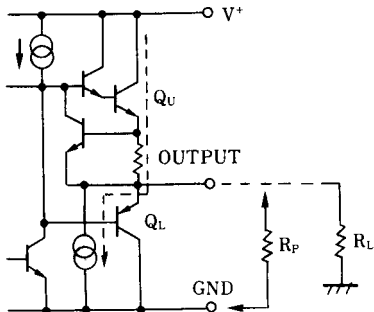

NJM2904, in its static state (No in and output condition) when design, Q_U being biased by constant current (break down beam) yet, Q_L stays OFF.

While using with both power source mode, the cross-over distortion might occur instantly when Q_L ON.

There might be cases when application for amplifier of audio signals, not only distortion but also the apparent frequency bandwidth being narrowed remarkably.

It is adjustable especially when using both power source mode, constantly to use with higher current on Q_U than the load current (including feedback current), and then connect the pull-down resistor R_P at the part between output and GND pins.

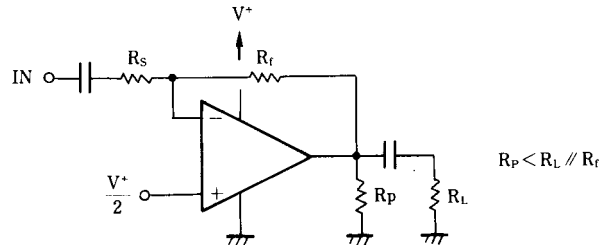
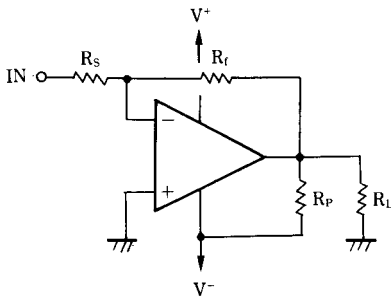



[CAUTION]

The specifications on this databook are only given for information, without any guarantee as regards either mistakes or omissions. The application circuits in this databook are described only to show representative usages of the product and not intended for the guarantee or permission of any right including the industrial rights.

Looking for pricing, stock, or lifecycle information?

Click below to explore more details on WIN SOURCE:

-  [View NJM2904M\(T1\) on WIN SOURCE](#)
-  [NJR Corporation/NJRC Information](#)

Optimize Your Supply Chain with WIN SOURCE Solutions

-  Global Sourcing Solution
-  Obsolete Management
-  Cost Control Management
-  Shortage Management
-  Alternative Solution
-  Excess Inventory Management