

## QUAD SINGLE-SUPPLY OPERATIONAL AMPLIFIER

### ■ GENERAL DESCRIPTION

The NJM2902 consists of four independent high-gain operational amplifiers that are designed for single-supply operation.

Operation from split power supplies is also possible and the low power supply drain is independent of the magnitude of the power supply voltage.

Used with a dual supply the circuit will operate over a wide range of supply voltages. However, a large amount of crossover distortion may occur with loads to ground. An external current-sinking resistor to  $-V_S$  will reduce crossover distortion. There is no crossover distortion problem in single-supply operation if the load is direct-coupled to ground.

### ■ PACKAGE OUTLINE

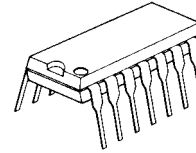

NJM2902N

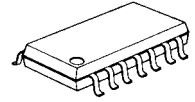

NJM2902M



NJM2902V

### ■ FEATURES

- Single Supply
- Operating Voltage ( +3V~+30V )
- High Output Voltage (  $V^+ - 2V$  )
- Slew Rate ( 0.5V/ $\mu$ s typ. )
- Low Operating Current ( 1mA typ. )
- Package Outline DIP14, DMP14, SSOP14
- Bipolar Technology

### ■ PIN CONFIGURATION

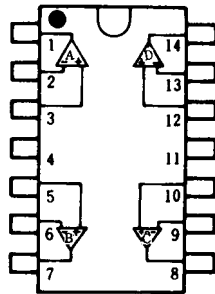

NJM2902N  
NJM2902M  
NJM2902V

#### PIN FUNCTION

- |                  |             |
|------------------|-------------|
| 1.A OUTPUT       | 8.C OUTPUT  |
| 2.A -INPUT       | 9.C -INPUT  |
| 3.A +INPUT       | 10.C +INPUT |
| 4.V <sup>+</sup> | 11.GND      |
| 5.B +INPUT       | 12.D +INPUT |
| 6.B -INPUT       | 13.D -INPUT |
| 7.B OUTPUT       | 14.D OUTPUT |

### ■ EQUIVALENT CIRCUIT ( 1/4 Shown )

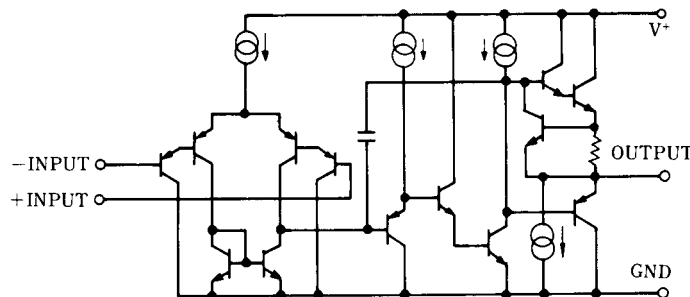

# NJM2902

## ■ ABSOLUTE MAXIMUM RATINGS

(Ta=25°C)

PARAMETER	SYMBOL	RATINGS	UNIT
Supply Voltage	$V^+(V^-/V)$	32 (or $\pm 16$ )	V
Differential Input Voltage	$V_{ID}$	32	V
Input Voltage	$V_{IC}$	-0.3~+32	V
Power Dissipation	$P_D$	(DIP14) 570 (DMP14) 300 (SSOP14) 300	mW
Operating Temperature Range	$T_{opr}$	-40~+85	°C
Storage Temperature Range	$T_{stg}$	-50~+125	°C

## ■ ELECTRICAL CHARACTERISTICS

(Ta=25°C,  $V^+=5V$ )

PARAMETER	SYMBOL	TEST CONDITION	MIN.	TYP.	MAX.	UNIT
Input Offset Voltage	$V_{IO}$	$R_S=0\Omega$	-	2	10	mV
Input Offset Current	$I_{IO}$	$I_{IN^+}-I_{IN^-}$	-	5	50	nA
Input Bias Current	$I_B$	$I_{IN^+}$ or $I_{IN^-}$	-	20	500	nA
Large Signal Voltage Gain	$A_V$	$R_L>2k\Omega$	-	100	-	V/mV
Maximum Output Voltage Swing	$V_{OM}$	$R_L=2k\Omega$	3.5	-	-	V
Input Common Mode Voltage Range	$V_{ICM}$		0~3.5	-	-	V
Common Mode Rejection Ratio	CMR		-	85	-	dB
Supply Voltage Rejection Ratio	SVR		-	100	-	dB
Output Source Current	$I_{SOURCE}$	$V_{IN^+}=1V, V_{IN^-}=0V$	20	40	-	mA
Output Sink Current	$I_{SINK}$	$V_{IN^+}=0V, V_{IN^-}=1V$	8	20	-	mA
Channel Separation	CS	$f=1k\sim 20kHz$ , Input Referred	-	120	-	dB
Operating Current	$I_{CC}$	$R_L=\infty$	-	1	2	mA
Slew Rate	SR	$V^+/V=\pm 15V$	-	0.5	-	V/ $\mu s$
Gain Bandwidth Product	GB	$V^+/V=\pm 15V$	-	0.5	-	MHz

## ■ TYPICAL CHARACTERISTICS

**Maximum Output Voltage Swing vs. Load Resistance**

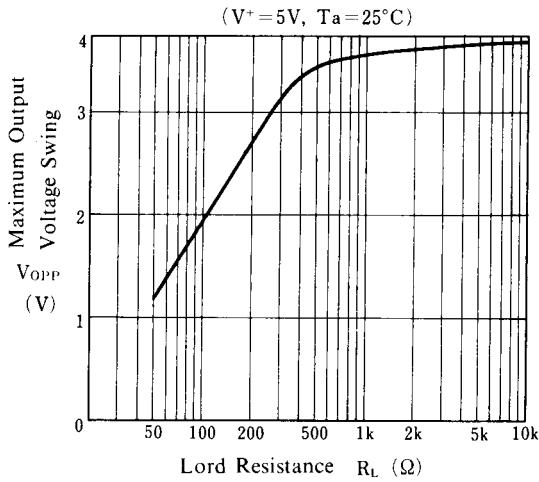

**Voltage Gain, Phase vs. Frequency**

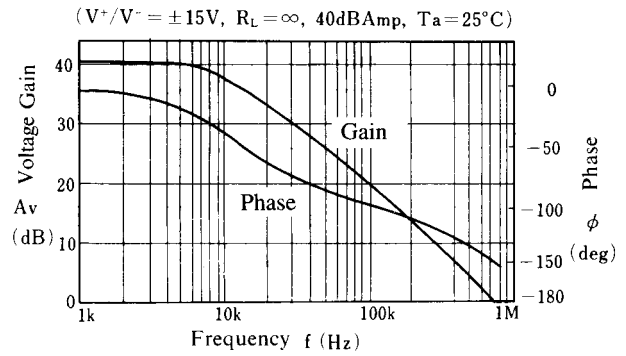

**Operating Current vs. Operating Voltage**

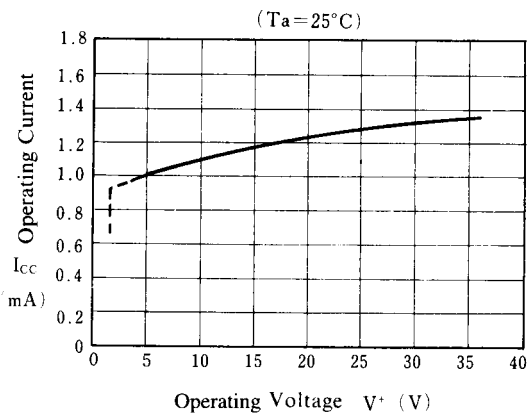

**Voltage Gain vs. Operating Voltage**

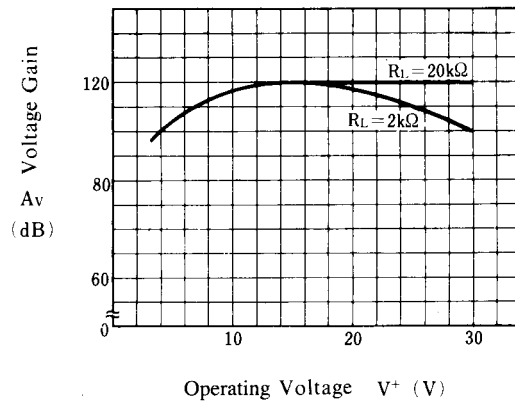

**Input Offset Voltage vs. Temperature**

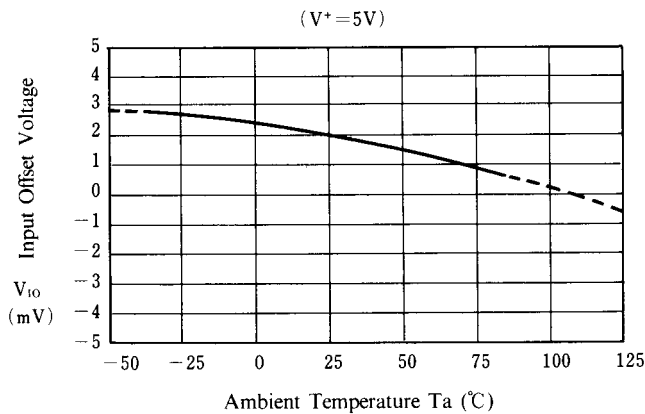

**Maximum Output Voltage vs. Operating Voltage**

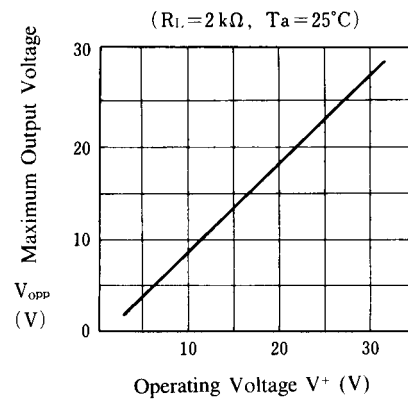

## ■ TYPICAL CHARACTERISTICS

**Input Offset Voltage vs. Temperature**

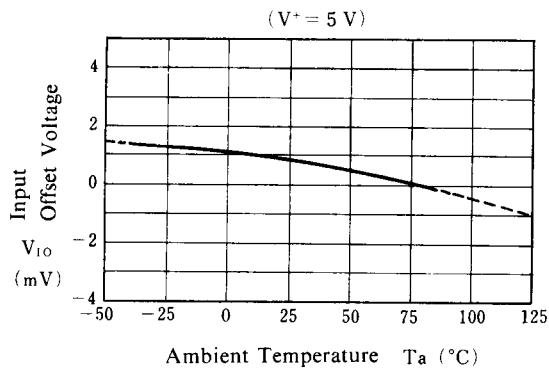

**Input Bias Current vs. Temperature**

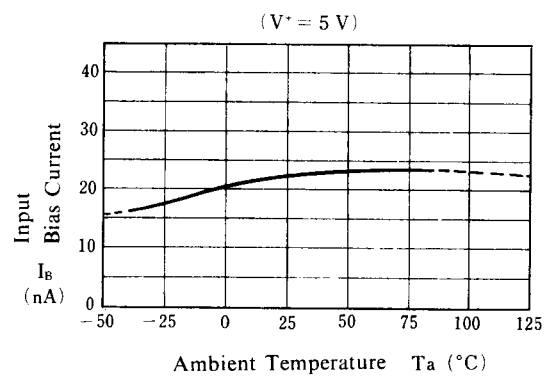

**Operating Current vs. Temperature**

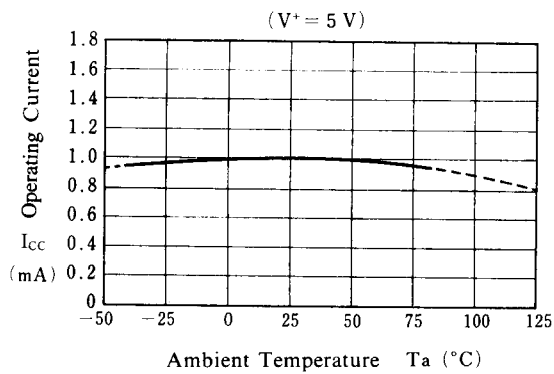

**Maximum Output Voltage Swing vs. Temperature**

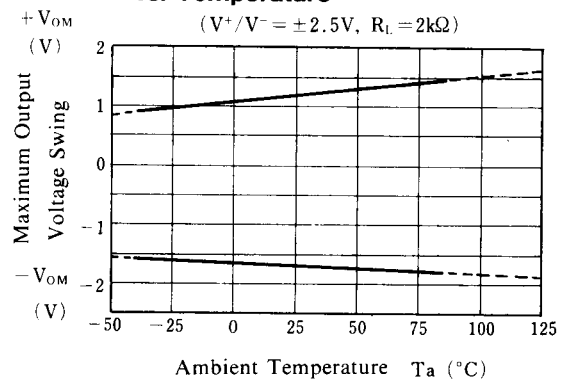

**Output Sink Current vs. Temperature**

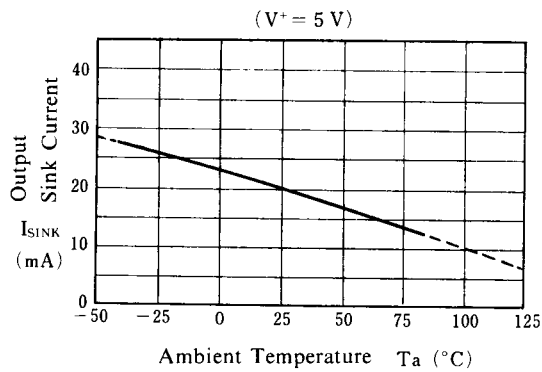

## ■ TYPICAL CHARACTERISTICS

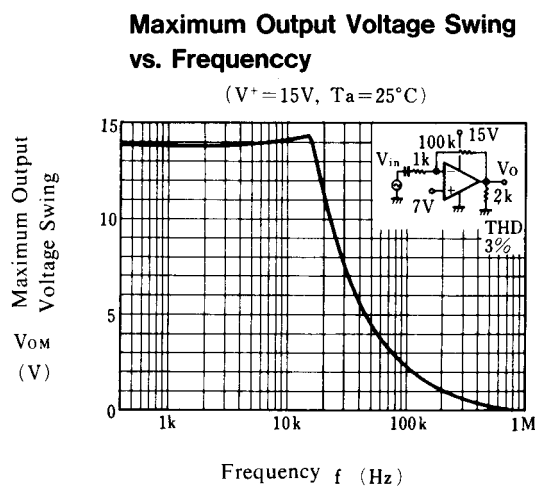
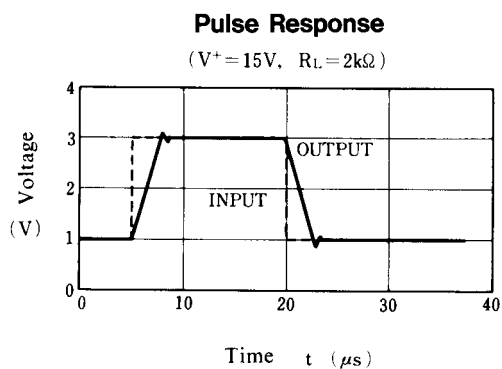
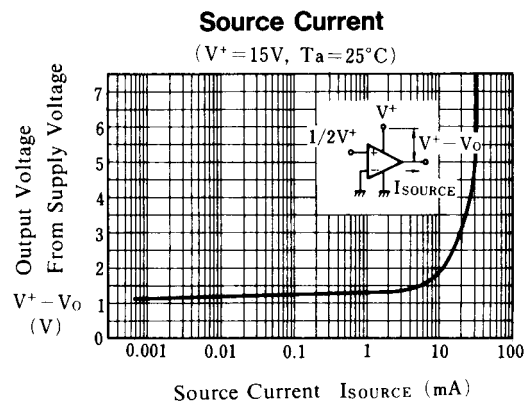
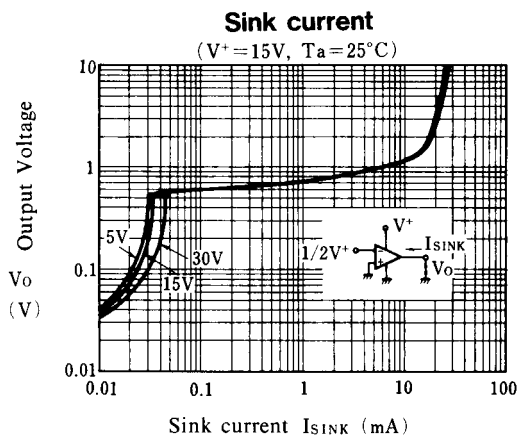

## ■ APPLICATION

Improvement of Cross-over Distortion

Equivalent circuit at the output stage

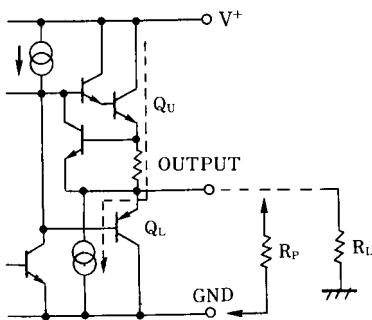

NJM2902, in its static state ( No in and output condition ) when design,  $Q_U$  being biased by constant current ( break down beam ) yet,  $Q_L$  stays OFF.

While using with both power source mode, the cross-over distortion might occur instantly when  $Q_L$  ON.

There might be cases when application for amplifier of audio signals, not only distortion but also the apparent frequency bandwidth being narrowed remarkably.

It is adjustable especially when using both power source mode, constantly to use with higher current on  $Q_U$  than the load current ( including feedback current ), and then connect the pull-down resistor  $R_P$  at the part between output and GND pins.

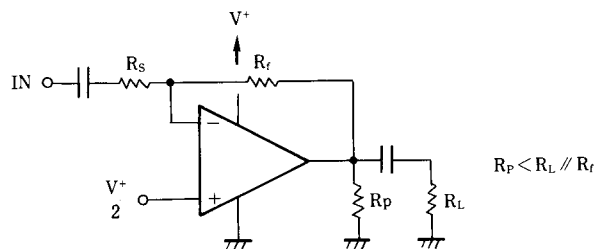
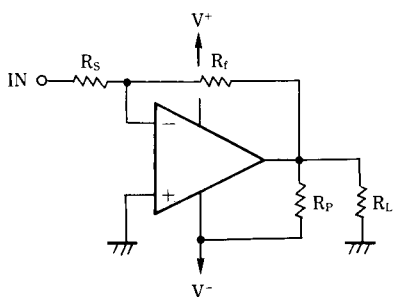



**[CAUTION]**

The specifications on this databook are only given for information, without any guarantee as regards either mistakes or omissions. The application circuits in this databook are described only to show representative usages of the product and not intended for the guarantee or permission of any right including the industrial rights.

## Looking for pricing, stock, or lifecycle information?

Click below to explore more details on WIN SOURCE:

-  [View NJM2902MZ on WIN SOURCE](#)
-  [NJR Corporation/NJRC Information](#)

## Optimize Your Supply Chain with WIN SOURCE Solutions

-  Global Sourcing Solution
-  Obsolete Management
-  Cost Control Management
-  Shortage Management
-  Alternative Solution
-  Excess Inventory Management