

WIDE BAND 3 CIRCUITS VIDEO SWITCH

■ GENERAL DESCRIPTION

The **NJM2584** is a wide band 2-Input 1-Output 3-Circuit video switch. It is suitable for Y, Pb, and Pr signal because frequency range is 50MHz.

The **NJM2584** is suitable for PTV, DTV, PDP and other high quality AV systems.

As for NJM2584A, the input coupling capacitor corresponds to 1uF.

■ PACKAGE OUTLINE

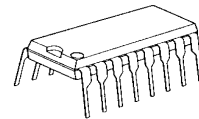

NJM2584D

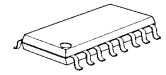

NJM2584M

■ FEATURES

- Operating Voltage 4.5 to 9.0V
- Wide frequency range 50MHz at 0dB typ.
- Internal 2 input-1output 3-circuit video switch
- Operating Current 10mA typ.
- Bipolar Technology
- Package Outline DIP16, DMP16

■ BLOCK DIAGRAM

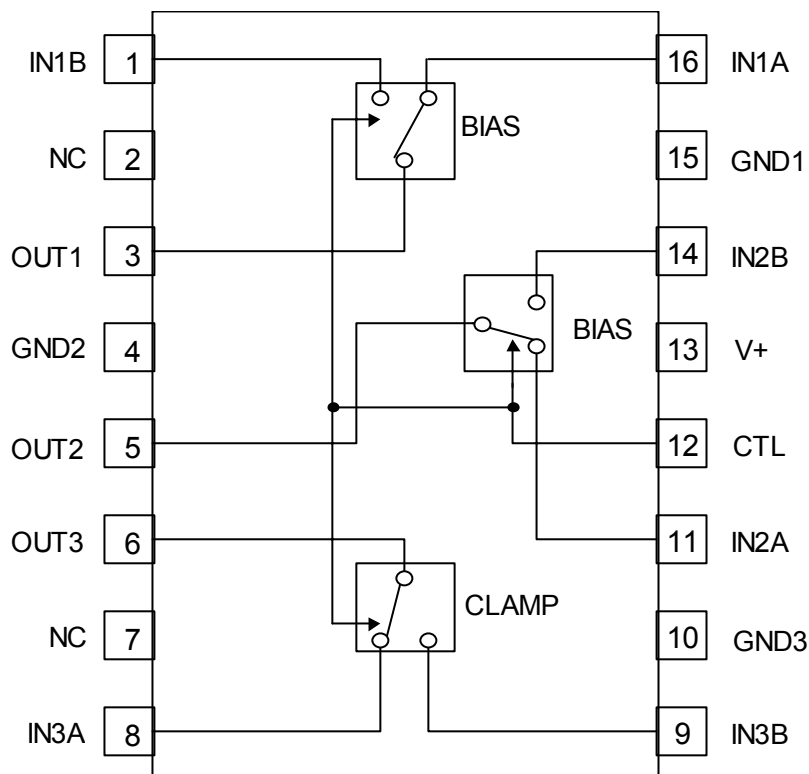

NJM2584

■ ABSOLUTE MAXIMUM RATINGS

(Ta=25°C)

PARAMETERS	SYMBOL	RATINGS	UNIT
Supply Voltage	V _{CC}	10.0	V
Power Dissipation	P _D	(DIP) 500 (DMP) 300	mW
Operating Temperature Range	Topr	-40 to +85	°C
Storage Temperature Range	Tstg	-40 to +125	°C

■ ELECTRICAL CHARACTERISTICS

(V_{CC}=5.0V, R_L=10kΩ, Ta=25°C)

PARAMETER	SYMBOL	TEST CONDITION	MIN.	TYP.	MAX.	UNIT
Operating Current	I _{CC}	No signal	-	10.0	15.0	mA
Maximum input Voltage 1	V _{im1}	BIAS input	3.2	3.5	-	Vp-p
Maximum input Voltage 2	V _{im2}	CLAMP input	2.4	2.6	-	Vp-p
Maximum Output Voltage 1	V _{om1}	BIAS input, Vin=1kHz, Sin signal, THD=1%,	3.2	3.5	-	Vp-p
Maximum Output Voltage 2	V _{om2}	CLAMP input, Vin=1kHz, Sin signal, THD=1%,	2.4	2.6	-	Vp-p
Voltage Gain	G _v	Vin=1MHz, 2.0Vp-p Sin signal	-0.5	0	0.5	dB
Differential Gain (Channel)	ΔG _{vI}	Vin=1MHz, 2.0Vp-p Sin signal	-0.2	0	0.2	dB
Differential Gain (Block)	ΔG _{vB}	Vin=1MHz, 2.0Vp-p Sin signal	-0.2	0	0.2	dB
Band Width	f		-	50	-	MHz
Frequency Characteristic	G _f	Vin=1MHz / 50MHz, 1.0Vp-p, Sin signal	-	0	-	dB
Channel Cross talk 1	CTI1	Vin=4.43MHz, 2.0Vp-p, Sin signal	-	-70	-60	dB
Channel Cross talk 2	CTI2	Vin=50MHz, 2.0Vp-p, Sin signal	-	-40	-	dB
Block Cross talk 1	CTB1	Vin=4.43MHz, 2.0Vp-p, Sin signal	-	-70	-60	dB
Block Cross talk 2	CTB2	Vin=50MHz, 2.0Vp-p, Sin signal	-	-40	-	dB
Differential Gain	DG	Vin=1.0Vpp 10step Video signal	-	0.3	-	%
Differential Phase	DP	Vin=1.0Vpp 10step Video signal	-	0.3	-	deg
S/N	SN _v	Vin=1.0Vpp, 100% White Video signal	-	+65	-	dB
Switch Change Voltage H Level	V _{thH}		2.0	-	V ⁺	V
Switch Change Voltage L Level	V _{thL}		0	-	0.6	V

■ MODE SWITCH FUNCTION

PIN	MODE	NOTES
Control	H	B channel output
	L	A channel output
	OPEN	A channel output

■ EQUIVALENT CIRCUIT (V+=5.0V)

PIN No.	PIN NAME	INSIDE EQUIVALENT CIRCUIT	VOLTAGE	Note
16 1 11 14	IN1A IN1B IN2A IN2B		2.90V	IN1A, IN2A CTL : L IN1B, IN2B CTL : H
8 9	IN3A IN3B		1.75V	IN3A CTL : L IN3B CTL : H
3 5 6	OUT1 OUT2 OUT3		(OUT1, OUT2) 2.10V (OUT3) 1.00V	
12	CTL		0V	
13	V+	_____		
15 4 10	GND1 GND2 GND3	_____		

NJM2584

TEST CIRCUIT1

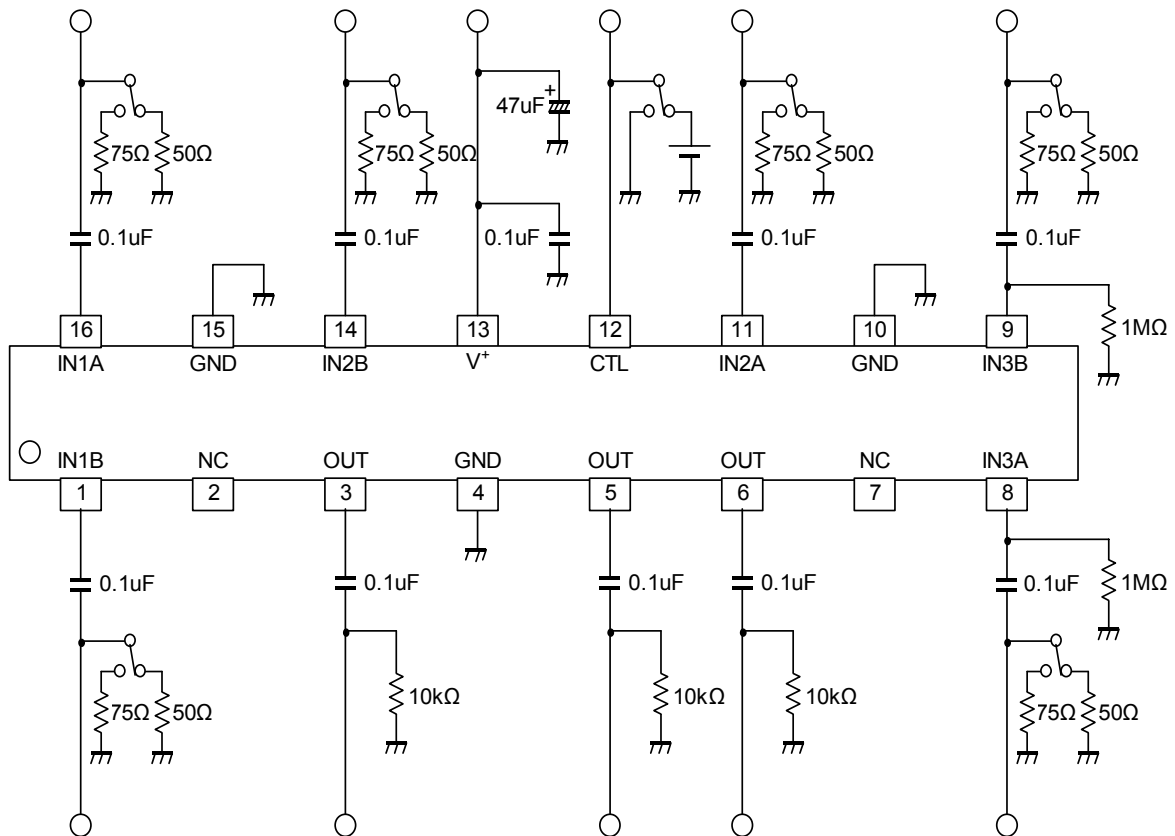

TEST CIRCUIT2 (DG, DP, S/N)

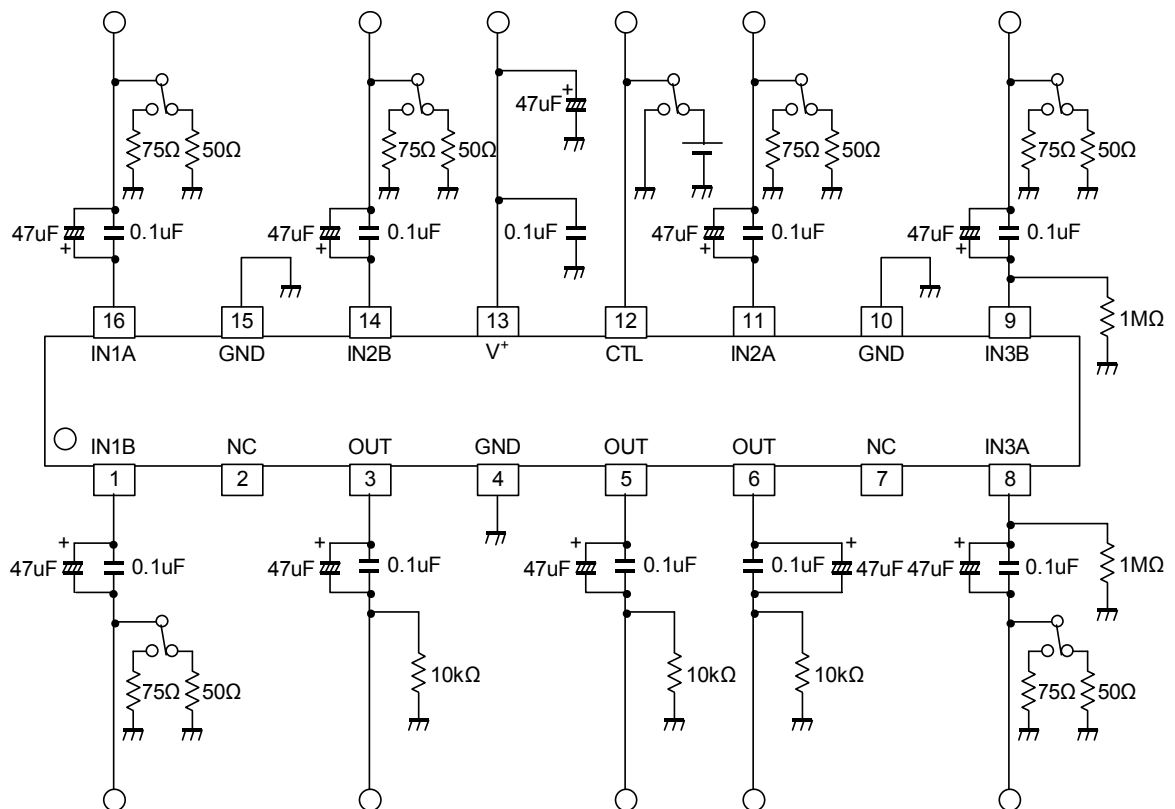

APPLICATION CIRCUIT

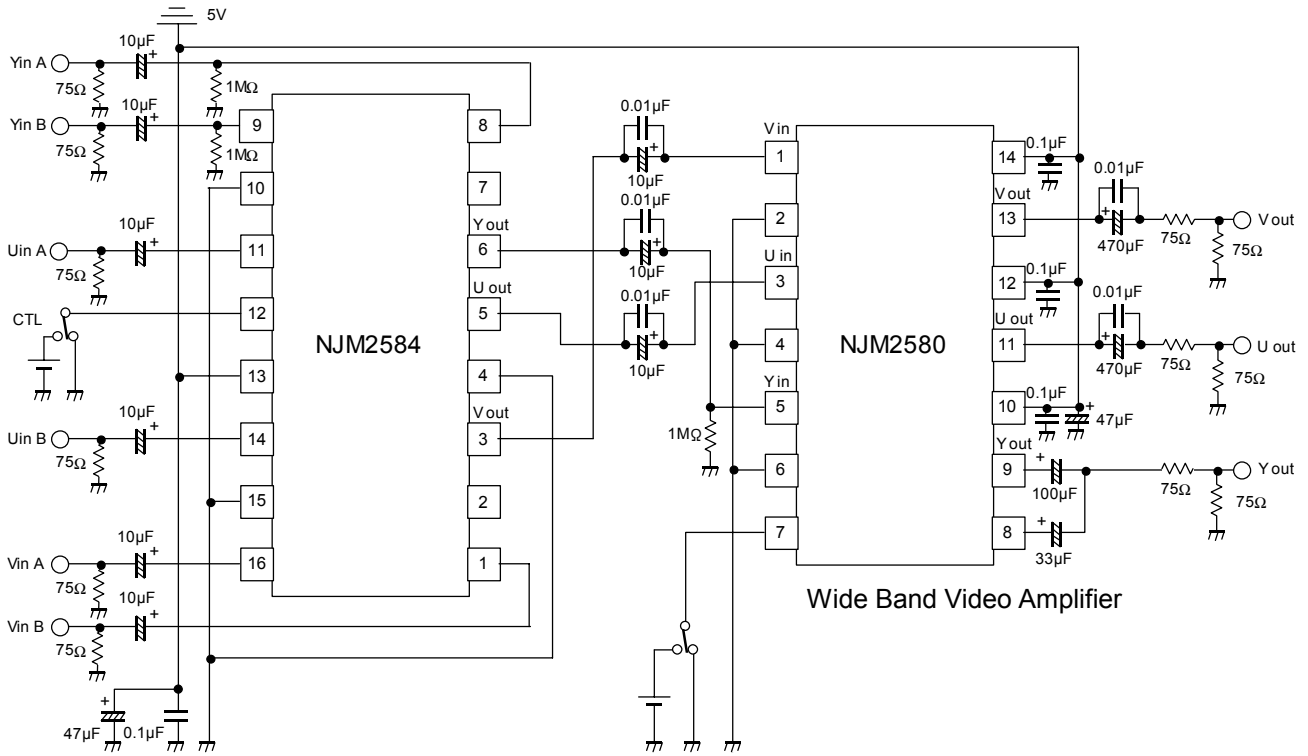

■ TYPICAL CHARACTERISTICS

Voltage Gain vs. Frequency

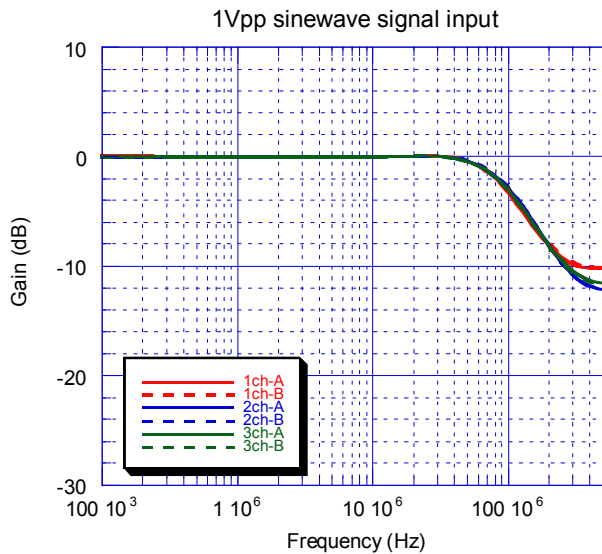

Operating Current vs. Supply Voltage

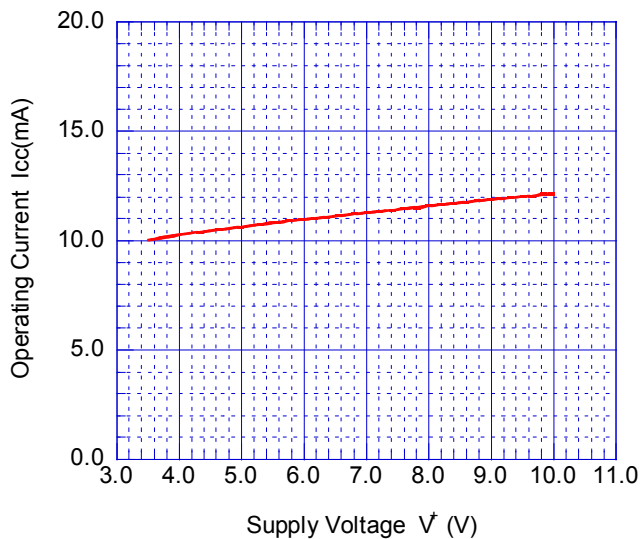

Maximum Input Voltage Swing vs. Supply Voltage (BIAS Type Input)

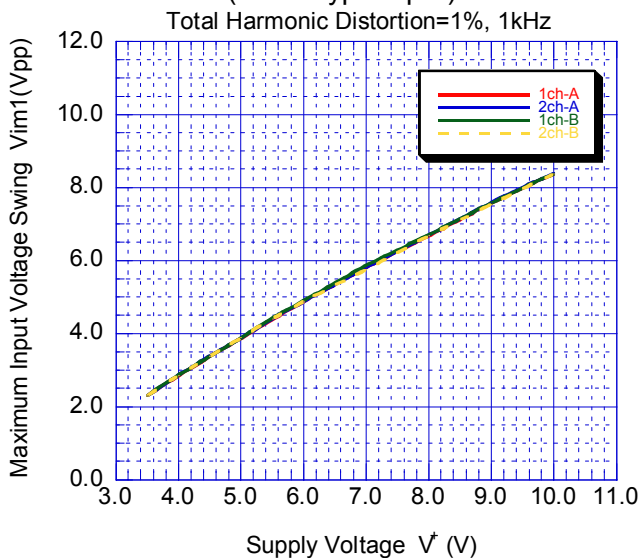

Maximum Input Voltage Swing vs. Supply Voltage (CLAMP Type Input)

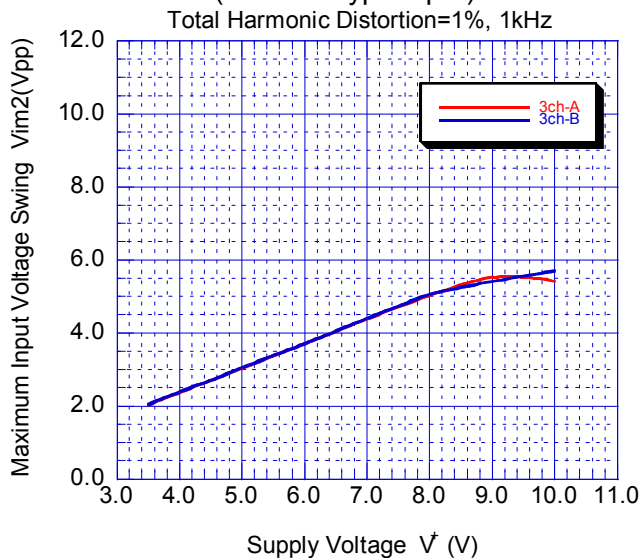

Maximum Output Voltage Swing vs. Supply Voltage (BIAS Type Input)

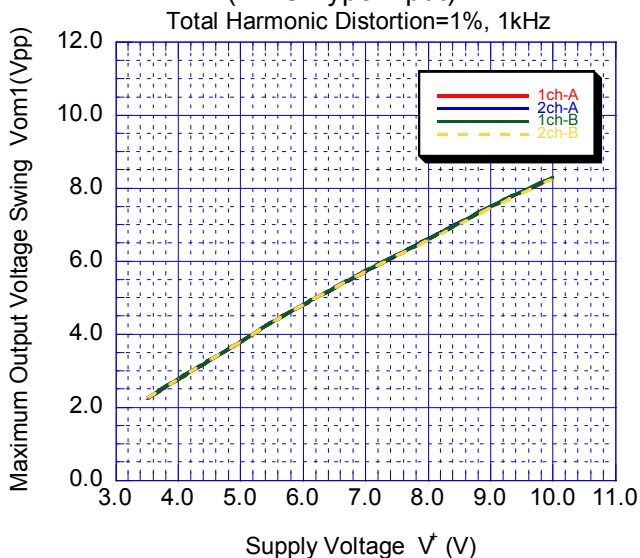

Maximum Output Voltage Swing vs. Supply Voltage (CLAMP Type Input)

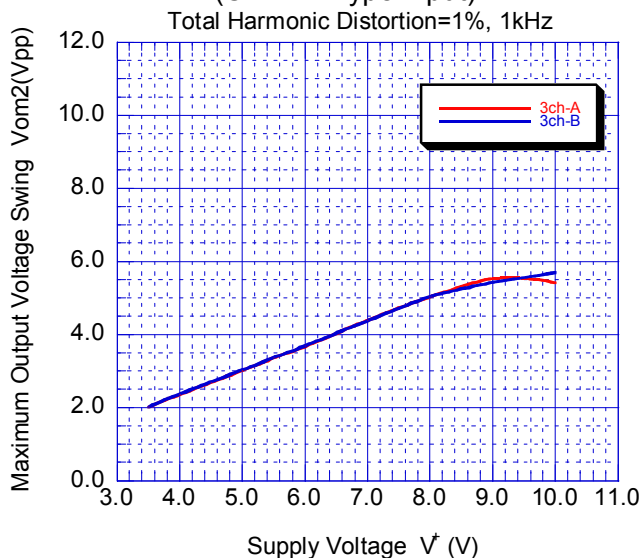

Voltage Gain vs. Supply Voltage
2Vpp, 1MHz sinewave signal input

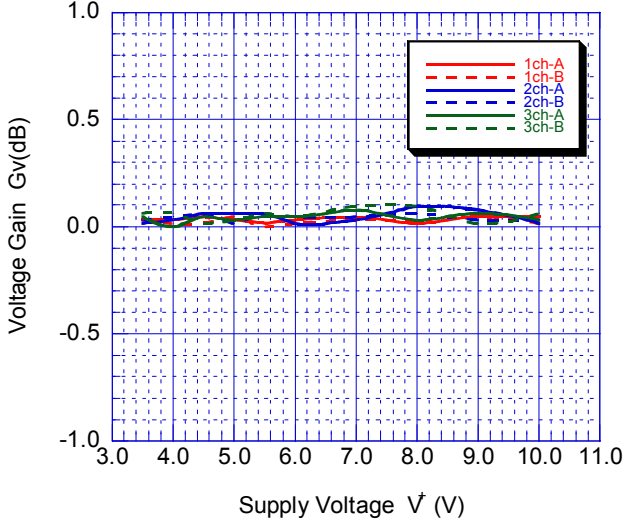

Input Gain Defference vs. Supply Voltage

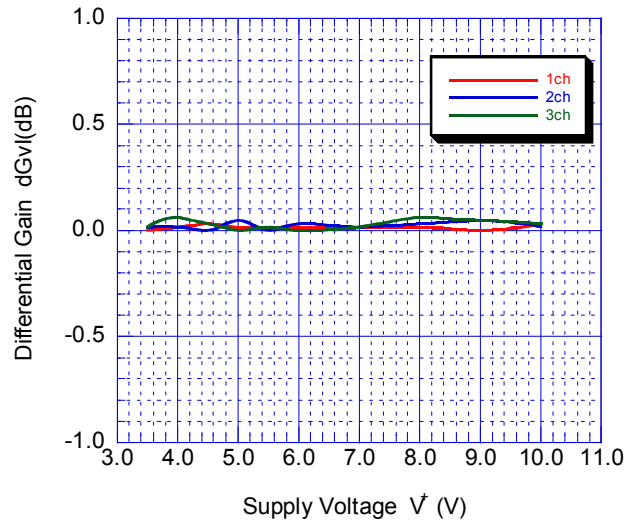

Channel Gain Defference vs. Supply Voltage

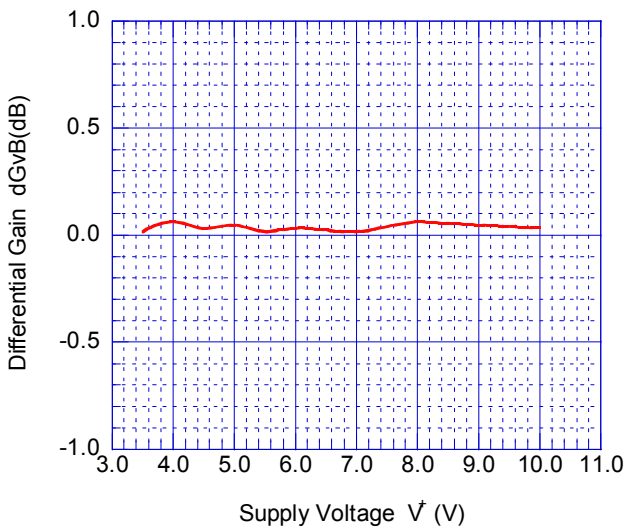

Gain Frequency Characteristics vs. Supply Voltage

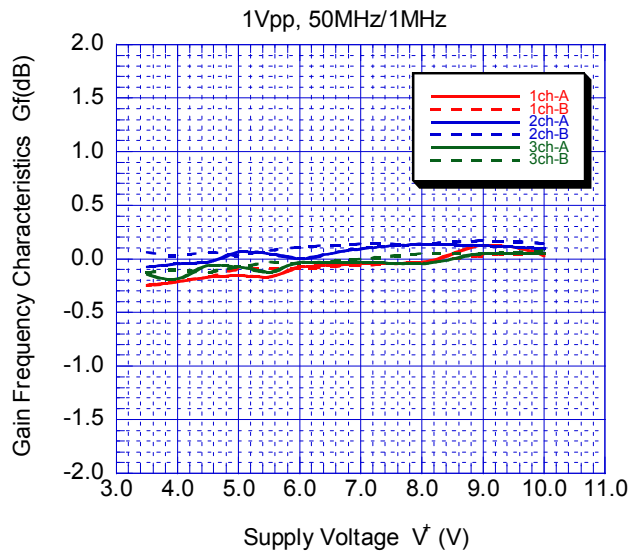

Input Cross Talk 1 vs. Supply Voltage
2Vpp, 4.43MHz sinewave signal input (Achannel)

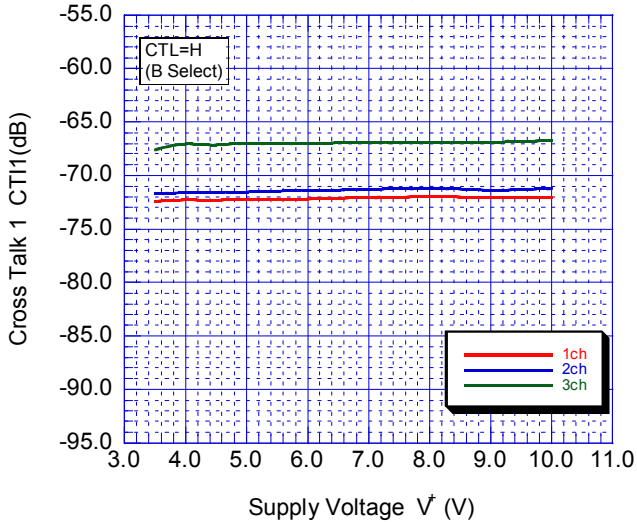

Input Cross Talk 1 vs. Supply Voltage
2Vpp, 4.43MHz sinewave signal input (Bchannel)

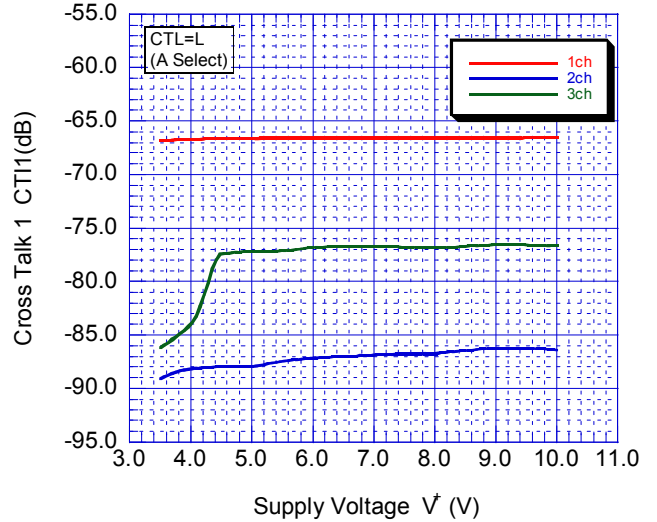

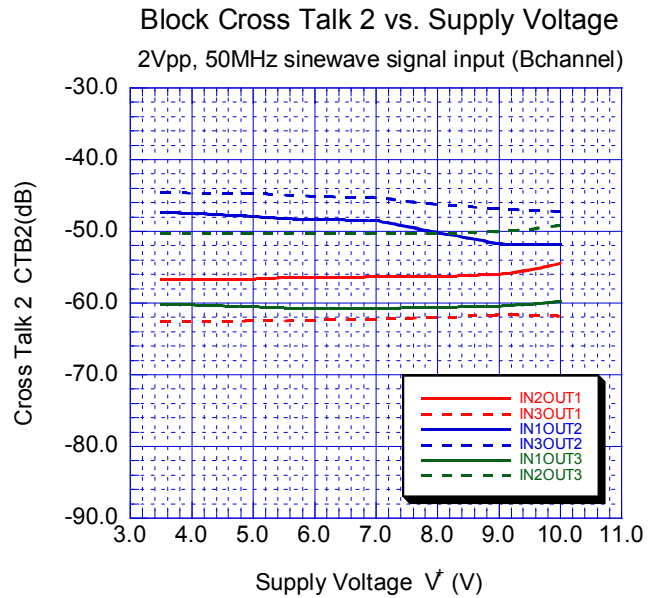
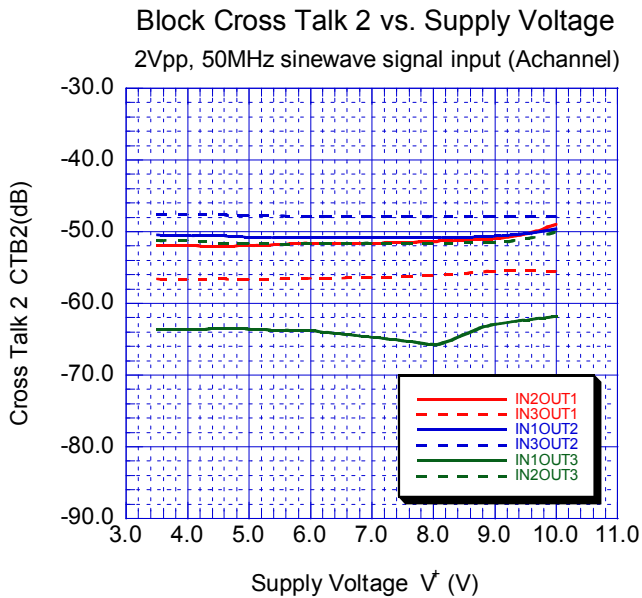
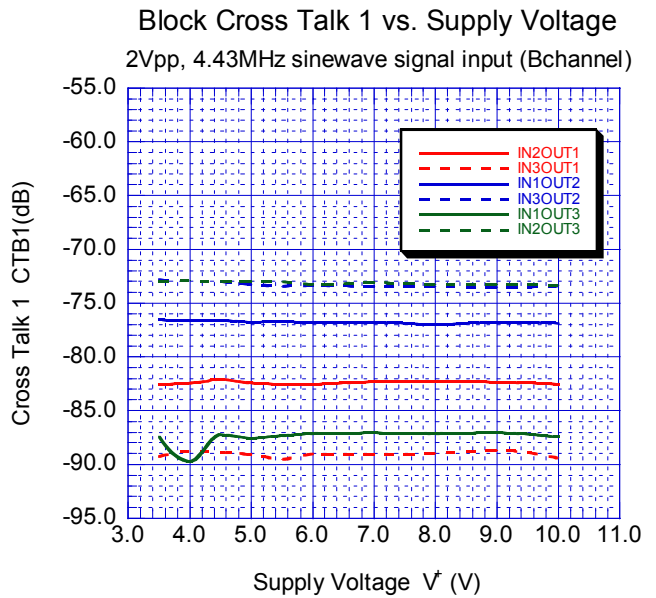
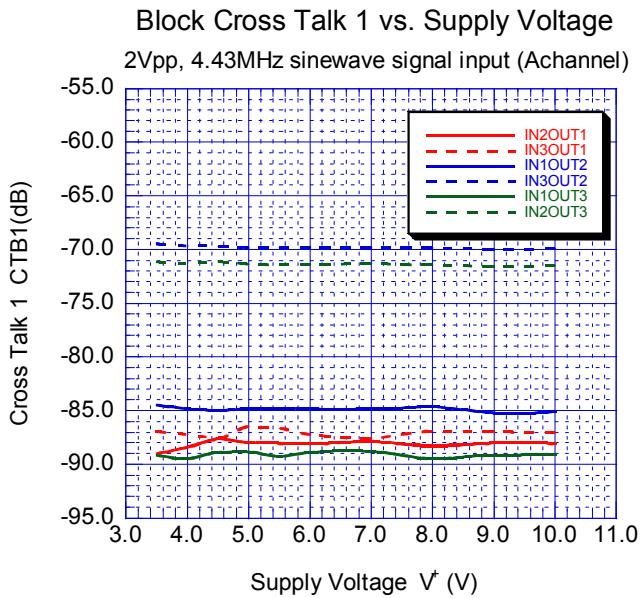
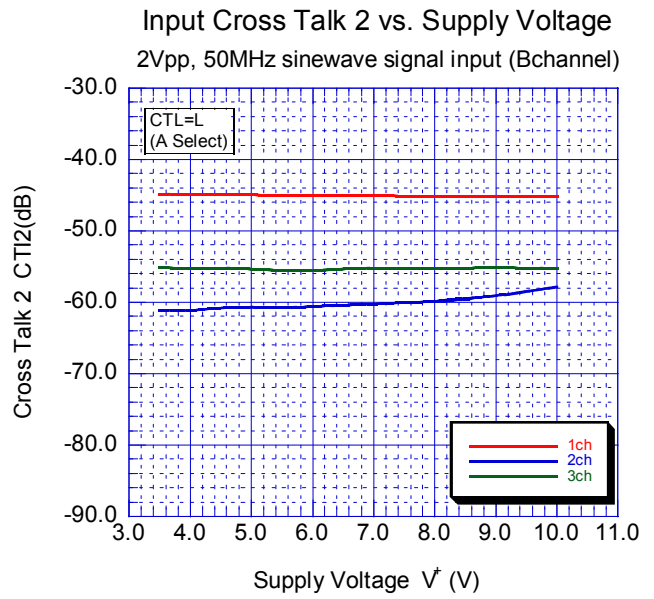
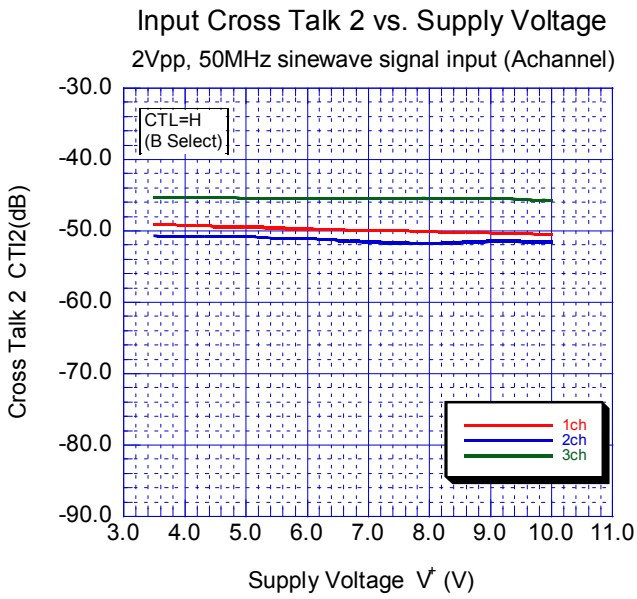

Differential Gain vs. Supply Voltage
1Vpp, 10step video signal input

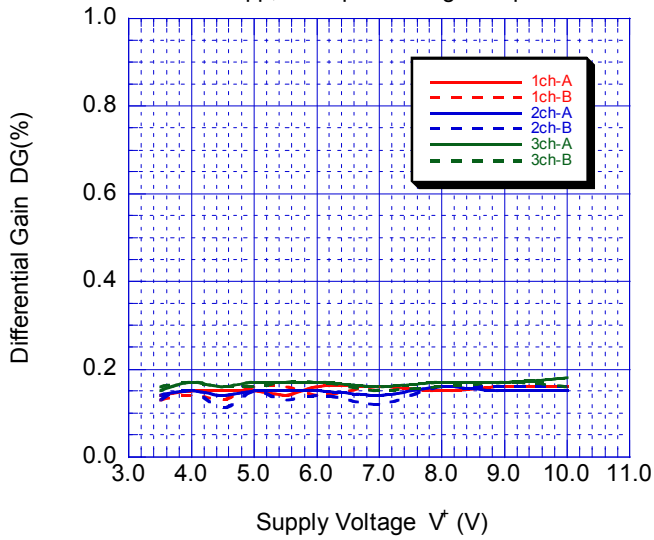

Differential Phase vs. Supply Voltage
1Vpp, 10step video signal input

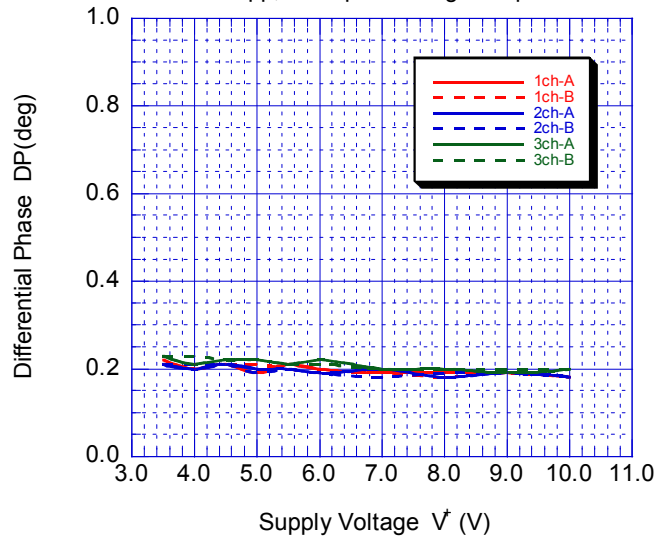

Signal to Noise Ratio vs. Supply Voltage
1Vpp, 100% white video signal input

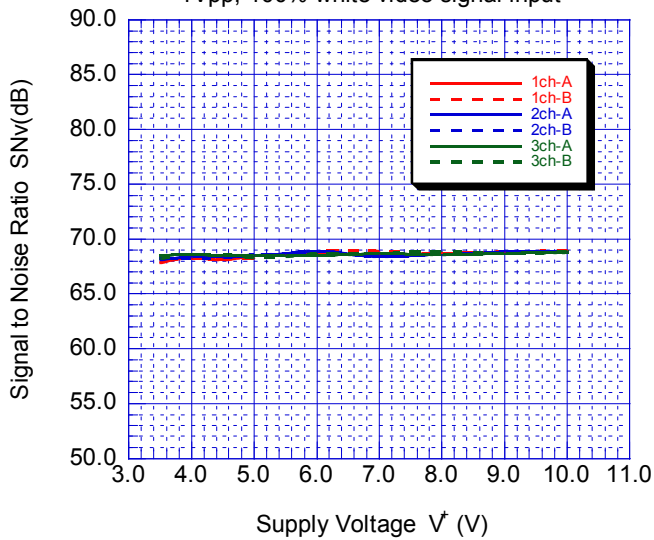

Switching Voltage H Level vs. Supply Voltage

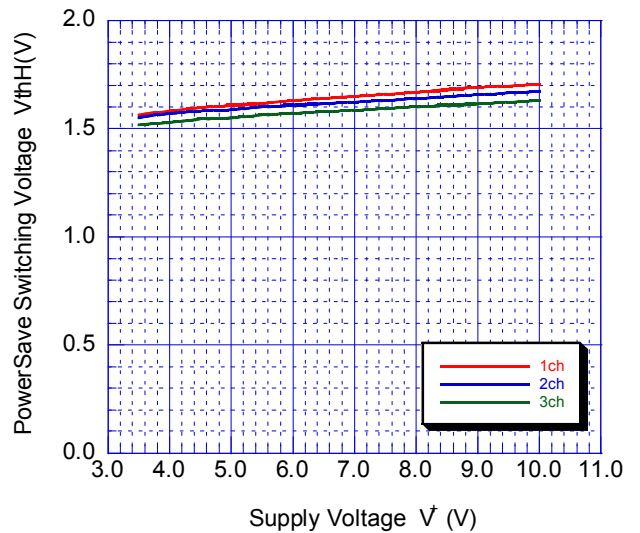

Switching Voltage L Level vs. Supply Voltage

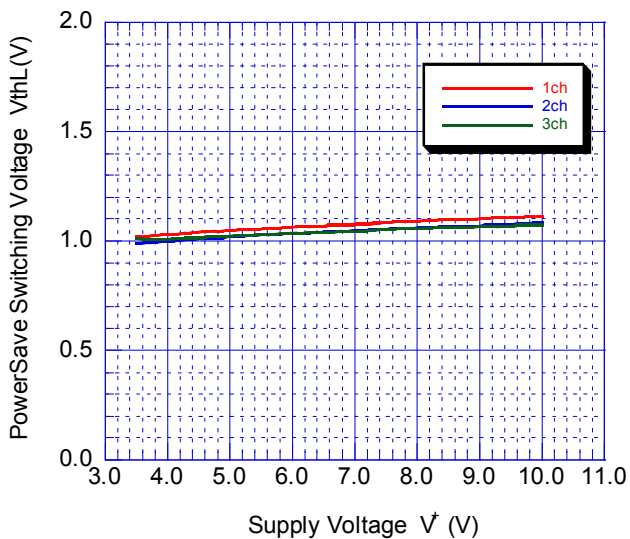

NJM2584

APPLICATION

This IC requires $1M\Omega$ resistance between INPUT and GND pin for clamp type input since the minute current causes an unstable pin voltage.

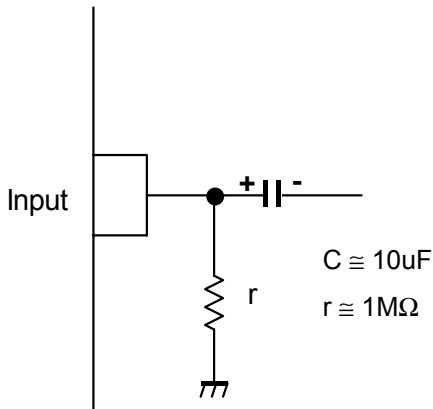

This IC requires $0.1\mu\text{F}$ capacitor between INPUT and GND, $1M\Omega$ resistance between INPUT and GND for clamp type input at mute mode.

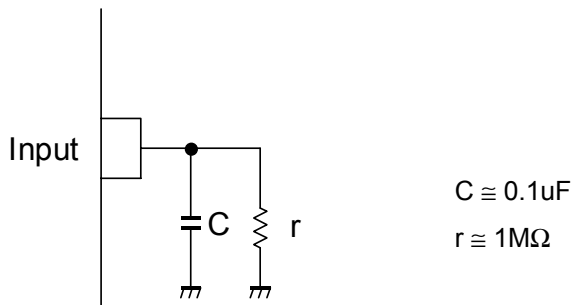

This IC requires $0.1\mu\text{F}$ capacitor between INPUT and GND for bias type input at mute mode.

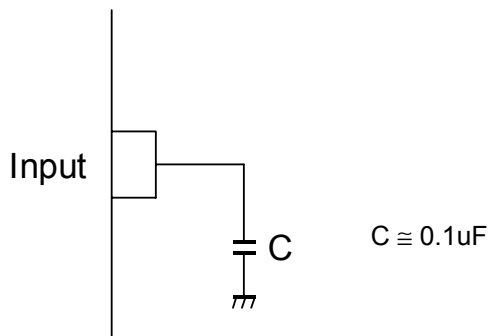

When the power supply voltage is not impressing, please do not impress voltage to the control terminal.

[CAUTION]
The specifications on this databook are only given for information, without any guarantee as regards either mistakes or omissions. The application circuits in this databook are described only to show representative usages of the product and not intended for the guarantee or permission of any right including the industrial rights.

Looking for pricing, stock, or lifecycle information?

Click below to explore more details on WIN SOURCE:

- ⊖ [View NJM2584AM-TE2 on WIN SOURCE](#)
- ⊖ [NJR Corporation/NJRC Information](#)

Optimize Your Supply Chain with WIN SOURCE Solutions

- ✓ Global Sourcing Solution
- ✓ Obsolete Management
- ✓ Cost Control Management
- ✓ Shortage Management
- ✓ Alternative Solution
- ✓ Excess Inventory Management